



Diamond[®]

EDGE[™] SERIES

PRICE & SPECIFICATION GUIDE

JULY 2020

An electronic version of this book will be kept updated with all revisions at

www.mbc11touch.com

1106289950

(ANY REVISIONS TO THIS DOCUMENT WILL NOT BE PRINTED.)

©2020 MasterBrand Cabinets, Inc. All rights reserved.

Diamond[®]

EDGE™ SERIES

Customer Service
Phone: 800.730.0171
Fax: 877.333.7122

Account Information

Account Code: _____

Designer ID: _____

Sales Rep Name: _____

Sales Rep Phone Number: _____

Sales Rep E-mail: _____

Sales Rep Fax: _____

General Customer Service Inquiries
edgecs@masterbrand.com

Order Submission
edgeorders@masterbrand.com

Notes

Table of Contents

Index	A•2-A•15
Design Checklist & NKBA Guidelines	B•1-B•3
Characteristics of Wood	C•1
Door Styles	D•1-D•20
Finishes	E•1-E•12
Specifications & Dimensions	F•1-F•14
Modifications	G•1-G•53
Specialty Doors	H•1-H•27
Logix® Reference Chart	I•1-I•2
Wall Cabinets	J•1-J•105
Wood Hoods & Hearths	K•1-K•26
Base Cabinets	L•1-L•109
Tall Cabinets	M•1-M•41
Microwave & Oven Cabinets	N•1-N•52
Office & Furniture Cabinets	O•1-O•40
Vanity Cabinets	P•1-P•67
Fillers & Panels	Q•1-Q•35
Mouldings & Embellishments	R•1-R•58
Kits & Hardware	S•1-S•18
Lighting	T•1-T•3
Specialty Collections	U•1-U•10
Policies & Forms	V•1-V•10

Description Index

How to Use Diamond Edge Product Codes

Prefix letters:

Prefix letters are abbreviations for the type of cabinet or other unit being described. For example, **B** designates a **Base** cabinet (such as a **B12 L** or **R**) and **W** designates a **Wall** cabinet (as in a **W1230 L** or **R**).

Product code numbers:

Numbers in a product code describe cabinet dimensions in inches.

For wall, oven, and tall cabinets, the first two digits indicate width, while the last two digits indicate height. That is, a **W1230 L** or **R** is 12" wide and 30" high.

For base and vanity cabinets, digits indicate width only. For instance, a **B12 L** or **R** is a base cabinet that is 12" wide.

Suffix letters:

Suffix letters in a product code designate standard options. For example, a **B15BB L** or **R** indicates a **Bread Board** option.

See the Modifications section of this catalog for a complete list of Diamond Edge option suffixes and their meanings.

Contents By Description

Description	Code	Page Number	Description	Code	Page Number
135° Corner Inside Base	BFH..CIA	I●88	Arch Valance	AV	R●18
135° Corner Inside Wall	..W..CIA	J●89	Art Corbel	..CORBELART	R●26
135° Corner Outside Base	BFH..COA	I●87	Arts & Crafts Corbel	..CORBELART	R●26
135° Corner Outside Wall	..W..COA	J●88	Arts & Crafts Open Corbel	..CORBELARTO	R●26
30" SuperCabinet	BSC30PR, R, RP, RS, SR	I●20	Asymmetrical Base Easy Reach	BER	I●69
36" SuperCabinet	BSC36PRP, PRS, SRP, SRS	I●21	Asymmetrical Easy Reach Wall Corner	..ER	J●64-J●65
4 Zone Dimming Receiver	4ZONEDIMREC	T●1	Attach Toekick Modification	ATTK	G●29
4 Zone Wall Controller	4ZONECON	T●1	Authentic Flush End Modification	AUTH	G●25
Abbey Column Insert - Bar	ABBEYCOLINST	R●49	Authentic Panels	..DAAUTHENTIC	Q●28
Abbey Column Insert - Island	ABBEYCOLINS	R●49	Automatic Opening Mechanism Activation Switch	..AOMACTSWITCH	S●13
Abbey Corbel Insert - Large	ABBEYCORINSL	R●28	Automatic Opening Mechanism Cable Clip	..AOMCABLECLIP	S●13
Abbey Corbel Insert - Medium	ABBEYCORINSM	R●28	Automatic Opening Mechanism Cable Connector	..AOMCABLECONN	S●13
Abbey Corbel Insert - Small	ABBEYCORINSS	R●28	Automatic Opening Mechanism Cable End Protector	..AOMCABLEPROT	S●13
Abbey Crown Insert	ABBEYINS	R●7	Automatic Opening Mechanism for Lift Up Systems Modification	..AOMD	G●9
Abbey Light Rail Insert	ABBEYINSS	R●7	Automatic Opening Mechanism for Wastebaskets Modification	..AOMBWB	G●9
Acanthus Decorative Onlays/Overlays	..ACOVLY	R●21	Automatic Opening Mechanism Universal Cable	..AOMCABLE	S●13
Acanthus Decorative Ornaments	..ACO	R●21	Band All Edges Modification	..BND.ALL	G●8
Acanthus Foot	..ACANFOOT	R●30	Banding Location Modification	..BND.FRT	G●8
Acanthus Leg	..ACANTHUSLEG	R●41	Bar Leg	..SBARLEG	R●35
Acanthus Rosette	..ROSETTEACA	R●16	Bar Leg, Square	..SQBARLEG	R●35
Accessory Nail	..ACCNAIL	R●16	Baroque Bracket	..BRACKETBAROQUE	R●24
Add Drawer Below Wall Unit Modification	ADRW	G●18	Baroque Column	..BARISLCOLUMN	R●45
Add Exterior Cool Light to Bottom of Wall Cabinet	..EXT.BTM.LGTC	T●3	Baroque Valance	..BARV	R●18
Add Exterior Warm Light to Bottom of Wall Cabinet	..EXT.BTM.LGTW	T●3	Base	..B	I●3
Add Interior Light to All Openings of Cabinet	..INT.ALL.LGT	T●2	Base Angled Cabinet	..BAC	I●86
Add Interior Light to Bottom Opening of Cabinet	..INT.BTM.LGT	T●3	Base Bottle Storage Kit	..BBSKIT18	S●2
Add Interior Light to Middle and Bottom Openings of Cabinet	..INT.MID.BTM.LGT	T●3	Base Box Column Pull-out, Overlay	..BBCPO..OL	I●91
Add Interior Light to Middle Opening of Cabinet	..INT.MID.LGT	T●2	Base Box Column Pull-out, Plain	..BBCPO	I●90
Add Interior Light to Single Opening Wall Cabinet or Corner Base Cabinet	..INT.LGT	T●2	Base Buffet	..B..B	I●4
Add Interior Light to Top and Bottom Openings of Cabinet	..INT.TOP.BTM.LGT	T●3	Base Buffet w/Roll Trays	..B..RTB	I●20
Add Interior Light to Top and Middle Openings of Cabinet	..INT.TOP.MID.LGT	T●3	Base Built-in Microwave Cabinet w/Drawer	..BBMWD	N●13
Add Interior Light to Top Opening of Cabinet	..INT.TOP.LGT	T●2	Base Can Storage Kit	..BPPKIT.PG	S●2
Add Shelf Modification	..ADD..SHLF	G●37	Base Combination Drawer Cabinet	..BCD	I●36
Add Toekick Modification	..ADDTK	G●29	Base Container Organization Pantry	..BCOPP	I●94
Aluminum Door Modification	..AF	G●14	Base Cooking Center w/Bread Board	..BCC..BB	I●37
Angled Base End Panel	..BEP	Q●15	Base Corner	..BC	I●59
Angled Corner Sink Base	..ACS	I●53	Base Corner Full Width	..BCFW	I●60
Angled Corner Sink Base w/Tilt-out Tray	..ACS..ST	I●54	Base Corner Full Width Peninsula	..BCFW..P	I●67
Angled Corner Sink Front	..ACSF	I●55	Base Corner Full Width Pull-out	..BCFW..PO	I●62
Angled Corner Sink Front Bottom	..ACSF..B	I●52	Base Corner Full Width w/Arched Pull-out	..BCFW..CPO	I●63
Angled End Wall Cabinet Double Door	..AEW	J●80, J●84	Base Corner Full Width w/Roll Trays & Swing-out	..BCFW..SP	I●63
Angled End Wall Cabinet Double Door w/Face Frame & Door on End	..AEWFFD	J●81, J●85	Base Corner Peninsula	..BCP	I●82
Angled End Wall Cabinet Single Door	..AEW	J●78, J●82	Base Corner Pull-out	..BC..PO	I●61
Angled End Wall Cabinet Single Door w/Face Frame & Door on End	..AEWFFD	J●79, J●83	Base Dishwasher Cabinet	..BDW	I●51
Angled Fillers	..FB, FO, FU, FV, FW	Q●13	Base Double Door w/Four Split Drawers	..B4D	I●18-I●19
Angled Soffit Trim Moulding	..ASTM	R●5	Base Double Door w/Four Split Drawers & Roll Tray	..B4D..RT	I●18
Angled Tall End Panels	..TEP	Q●15	Base Double Door w/Four Split Drawers & Roll Trays	..B4D..RT	I●19
Angled Wall End Panel	..WEP	Q●14	Base, Drop-in Range	..B..DR	I●56
Apex Leg	..APEXLEG	R●41	Base Easy Access Storage	..BEAS	I●15
			Base Easy Reach	..BER	I●70

Description	Code	Page Number
Base Easy Reach w/Lazy Susan	.BER..S	.1●73
Base Easy Reach w/Reduced Shelf	.BER..RS	.1●71
Base End Cabinet	.BEC	.1●85
Base End Panel	.BEPF..WD, BEPWD	.0●14
Base Fillers	.FB	.0●2
Base Fluted Fillers	.FFB	.0●4
Base Half Round End Shelf	.BHRES.	.1●101
Base Lazy Susan	.BLS	.1●68
Base Message Center	.BMC	.1●109
Base Microwave Cabinet w/Deep Drawer	.BMWD..DD	.N●14
Base Microwave Cabinet w/Drawer	.BMWD	.N●13
Base Microwave Cabinet w/Roll Tray(s)	.BMW..RT	.N●12
Base Open Basket Kits	.BASKET	.S●3
Base Open Basket w/Arched Valance	.BOB..AV	.1●90
Base Open Cabinet w/Car Siding Back	.BOCB	.1●107
Base Open Cabinet w/Car Siding Back & Drawer	.BODB	.1●108
Base Open Cabinet w/Plain Back	.BOCP	.1●107
Base Open Cabinet w/Plain Back & Drawer	.BODP	.1●108
Base Oven Cabinet	.BO..AC	.N●15
Base Oven Cabinet w/Lower Drawer	.BO..LD	.N●16
Base Oven Trimmable Cabinet	.BO	.N●14
Base Overlay Fillers	.OFB	.0●9
Base Pans Storage	.BPS..KIT	.S●3
Base Pantry Can Storage	.BPCS	.1●37
Base Pantry Pull-out	.BPP	.1●91
Base Peninsula	.B..P	.1●80
Base Pots & Pans Pull-out	.BPPP	.1●35
Base Pots & Pans Storage	.BPS	.1●35
Base Quarter Round End Shelf	.BQRES	.1●101
Base Rotating Deep Bin	.BRDB	.1●77
Base Shoe Moulding	.BSM	.R●9
Base Sliding Door Island Cabinet	.B..SDI	.1●79
Base Sliding Door Island Cabinet w/Sliding Desk	.B..SDIDSK	.1●79
Base Spice Drawer	.BSD	.1●100
Base Spice Pull-out	.BSP..PG	.1●92
Base SuperCabinet Gourmet	.BSCG	.1●22
Base Transition Cabinet	.BTC	.1●84
Base Tray Divider Pantry Pull-out	.BTDP	.1●93
Base Utensil Pantry Pull-out	.BUPP	.1●92
Base Utensil Pantry Pull-out w/Knife Block	.BUPPKB	.1●93
Base Wastebasket	.BWB	.1●95
Base Wastebasket Full Height	.BWB..FH	.1●96
Base Wastebasket Full Height w/Roll Tray	.BWB..FHRT2	.1●97
Base Wastebasket Lid	.BWBFLID, BWBLID	.S●12
Base Wastebasket w/Bread Board	.BWB..BB	.1●97
Base Wastebasket w/Charging Drawer	.BWB..CHGDRW	.1●99
Base Wastebasket w/Wood Tiered Cutlery Divider	.BWB..WTC	.1●98
Base Wastebasket w/Wood Tiered K-Cup Drawer	.BWB..KCUP	.1●98
Base Wine Cubby	.BWC	.1●100
Base w/Bottle Storage	.BBS	.1●101
Base w/Bread Board	.B..BB	.1●4
Base w/Charging Drawer	.B..CHGDRW	.1●5
Base w/Cutlery Insert Wood Dividers	.B..CIW	.1●9
Base w/Cutlery Insert Wood Dividers & Roll Trays	.B..RTCIW	.1●10
Base w/Drawer & Lid Organizer & Roll Trays	.B..RTL	.1●36
Base w/Food Storage Container Organizer	.B..FSCO	.1●11
Base w/Mixer Shelf	.B..FHMIXSC	.1●89
Base w/Plastic Storage Bins	.B..PSB	.1●89
Base w/Reduced Depth Roll Trays, Drop-in Range	.B..RTDR	.1●57
Base w/Roll Trays	.B..RT	.1●6
Base w/Roll Trays & Charging Drawer	.B..CHGDRWT	.1●7
Base w/Roll Trays, Drop-in Range	.B..RRTDR	.1●57
Base w/Roll-out Tray Divider	.B..TDRO	.1●84
Base w/Spice Drawer	.B..SD	.1●94
Base w/Tray Divider	.TD	.1●83
Base w/Two Split Drawers	.B2D	.1●16
Base w/Two Split Drawers & Roll Tray	.B2D..RT	.1●17
Base w/Wood Tiered Cutlery Divider	.B..WTC	.1●7
Base w/Wood Tiered Cutlery Divider & Roll Trays	.B..RTWTC	.1●8
Base w/Wood Tiered K-Cup Drawer	.B..KCUP	.1●10
Base w/Wood Tiered K-Cup Drawer & Roll Trays	.B..KCUPRT	.1●11

Description	Code	Page Number
Baseboard Moulding Sculpted	.BBMSC	.R●9
Baseboard Moulding Shaker	.BBMSH	.R●9
Bath Base Cabinet	.BCB..NTK	.P●53
Bath Channel Wall Mirror	.BCCWM	.P●66
Bath Drawer Sink Base	.BCDB	.P●59
Bath Drawer Sink Vanity	.BCDRW	.P●60
Bath Drawer Sink Vanity Platform	.BCPLATFORM	.P●60
Bath Drop Tray Sink Base	.BCBDT..NTK	.P●60
Bath Feet	.FOOTMETAL	.P●67
Bath Framed Wall Mirror	.BCFWM	.P●66
Bath Glass Shelf	.GSK	.S●7
Bath Grooming Pull-out Kit	.GPOKIT	.P●67
Bath Hamper Kit	.HAMPERKIT	.P●66
Bath Hamper Sink Base	.BCBH..D	.P●56
Bath Mirror Wall Pull-out	.VMP	.P●66
Bath Sink Base Cabinet w/Doors	.BCBCD	.P●55
Bath Sink Base Cabinet w/Shelf	.BCBCO	.P●54
Bath Sink Wall Tower	.BCWT	.P●53
Bath Storage Tower	.BCST	.P●61
Bath Storage Tower Double Drawer	.BCSTDRW	.P●64
Bath Storage Tower Single Drawer	.BCSTDRW	.P●62-P●63
Bath Tank Topper	.BCTT	.P●65
Bath Tank Topper Open Shelf	.BCTTOS	.P●65
Bath Two Drawer Sink Base	.BC2DB	.P●59
Bath Wall Hung Sink Console	.BCWHC	.P●52
Bath Wall Hung Sink Drawer Base	.BCWHDB	.P●56-P●57
Bath Wall Hung Sink w/Grooming Pull-out	.BCWHDBPO..D	.P●58
Beaded Inset Door Modification	.BEADED	.G●12
Beveled Edge Moulding	.TCM	.R●7
Bijou Bun Foot	.BIJBUNFOOT	.R●32
Bottom Valance Rail Modification	.BVR	.G●18
Box Column Fillers, Base	.B..BCFP	.Q●11
Box Column Fillers, Office	.O..BCFP	.Q●11
Box Column Fillers, Tall	.T..BCFP	.Q●12
Box Column Fillers, Vanity	.V..BCFP	.Q●11
Box Column Fillers, Wall	.W..BCFP	.Q●10
Braided Moulding	.BRAIDM	.R●6
Bread Board	.BBOARDKIT	.S●3
Built-in Oven/Microwave Cabinet	.O.MC..AC	.N●22-N●26
Built-in Double Oven Cabinet	.OCD..AC	.N●47-N●50
Built-in Single Oven Cabinet	.OCS..AC	.N●39-N●42
Built-in Single Oven Cabinet w/Drawers	.OCS.D..AC	.N●31-N●34
Bunn Foot	.ROBUNNFOOT	.R●29
Cabinet Box Only Modification	.CBO	.G●19
Cabinet Care Kit (PURE&SIMPLE™)	.CABCLEANKIT	.S●16
Cabinet Case Only Modification	.CCO	.G●19
Cabinet False Panel Modification	.CFP	.G●31
Cabinet Frame Only Modification	.CFRMO	.G●20
Cabinet Front Only Modification	.CFNTO	.G●20
Cabinet No Door Modification	.CND	.G●20
Cabinet Panel Edge	.CPE	.R●9
CabMat	.CABMAT	.S●13
CabMat Modification	.CMAT	.G●37
CabMat Vanity	.CABMATV	.S●14
Cap Moulding	.CAPM	.R●4
Car Siding	.CSDG	.Q●21
Car Siding Back Modification	.CSDGBK	.G●37
Car Siding Flush Panel End Modification	.CSFPE	.G●25
Celtic Bracket	.BRACKETCELTIC	.R●24
Celtic Corbel	.CORBELCELTIC	.R●26
Celtic Foot	.CELTICFOOT	.R●30
Center Beaded Moulding	.CBEADM	.R●6
Charging Drawer	.CHGDRW	.S●6
Charging Drawer Modification	.CHGDRW	.G●38
Charleston Bead Column w/Foot	.WFOOTCHARLESTON	.R●47
Charleston Bead Column, Double Square	.DBLSQCHARLESTON	.R●48
Charleston Pedestal	.CHARLESPESED	.R●44
Chrome Hamper	.HAMPERKIT	.S●12
Classic Bun Foot	.CLBUNNFOOT	.R●29
Classic Revival Corbel	.CORBELCLREV	.R●26
Classic Tall Crown Moulding	.CLTCROWN	.R●2

Description Index

Description	Code	Page Number
Classic Wood Hood Arch	.WHA	.K●3
Classic Wood Hood Chimney	.WHC	.K●4
Classic Wood Hood Square	.WHS	.K●4
Clipped Corner Modification	.CLIP	.G●20
Clipped Corner Wood Tops Modification	.WTCCLIP	.G●35
Concave Light Rail Moulding	.CNVLRAIL	.R●5
Contemporary Cap	.CONCAP	.R●48
Contemporary Light Rail Moulding	.JINSERTLRC	.R●5
Cooking Utensil Divider	.CUD	.S●4
Cooking Utensil Divider	.CUDD	.S●3
Corner End Panels	.BEP, TCEP, WEP	.Q●23
Corner Sink Base without Shelf	.CS	.L●68
Corner Strap	.APEXSTRP	.R●24
Corner Tall Moulding	.DCM	.Q●23
Cornice Tall Crown Moulding	.COTCROWN	.R●2
Cosmo Foot	.COSFOOT	.R●30
Countertop Support	.SBS	.R●23
Country Sink Base Cabinet	.CNTYSB	.L●48
Country Sink Base w/CabMat	.CNTYSB..CM	.L●49
Cove Crown Moulding	.COVECROWN	.R●2
CPU Base	.CPU	.O●25
Craftsman Bun Foot	.CRFTSMNBUNFOOT	.R●32
Craftsman Carbel	.CORBELCRAFT	.R●25
Craftsman Carbel Open	.CORBELCRAFTO	.R●24
Craftsman Door Modification	.CCG, CCP	.G●14
Craftsman Foot	.CRFTSMNFOOT	.R●31
Craftsman Foot, Corner	.CRFTSMNFOOTC	.R●32
Create-A-Crown Insert	.INSERTFRM	.R●4
Criss Cross Wine Rack Material	.WNRMAT	.Q●20
Crown Moulding	.SWCRM	.R●2
Cut-for-glass Modification	.CG	.G●14
Cutlery Divider	.CIW	.S●5
Deco Baseboard Moulding	.DECOBBM	.R●9
Decorative Baseboard Moulding	.BBM	.R●9
Decorative Pulls & Knobs	.KNOB, PULL	.S●17-S●18
Deep Roll Tray Kit	.DGGK..FXSRTPG, DRT..SP	.S●9
Deep Roll Trays Modification	.DRT	.G●31
Dentil Moulding	.MDENTIL8	.R●6
Desk Door Drawer Base	.DDO	.O●22
Desk Drawer Base	.DDR	.O●24
Desk File Drawer Base	.DF3D	.O●24
Desk File Drawer Base	.DFD	.L●102
Desk Office Base w/Full Height Doors	.DO..FH	.O●23
Diagonal Base w/Full Height Door & Lazy Susan	.DAB..S	.L●73
Diagonal Base w/Full Height Door & Super Lazy Susan	.DAB..SLS	.L●75
Diagonal Base w/Full Shelf	.DAB..FS	.L●70
Diagonal Corner Sink Base without Shelf	.DAB	.L●69
Diagonal Wall	.DW, DW..D	.J●66
Diagonal Wall Peninsula	.DW..P	.J●73
Diagonal Wall w/Appliance Garage & Lazy Susan Open Bottom	.DW..DS	.J●70
Diagonal Wall w/Appliance Garage Open Bottom	.DW..D	.J●69
Diagonal Wall w/Full Height Door	.DW..FH	.J●67
Diagonal Wall w/Lazy Susan	.DW..DS, DW..S	.J●70
Diagonal Wall w/Vertical-Lift	.DW..AG	.J●71
Diagonal Wall w/Vertical-Lift & Lazy Susan	.DW..AGS	.J●72
Dishwasher Panel	.DWPWD	.Q●20
Door Only	.DOORONLY	.H●1
Door Rail Material	.CGRAIL, DRRAILCROSS, DRRAILEND, DRWRAILCROSS, DRWRAILEND, MUNTIN	.Q●23
Double Hook Black	.EEHDB	.O●8
Double Hook Nickel	.EEHDN	.O●8
Double Outlet Cover	.DOC	.R●50
Double Oven Trimmable Cabinet	.OCD	.N●35-N●36
Double Oven Trimmable Cabinet w/Deep Drawer	.OCD..DD	.N●51-N●52
Double Rocker Plate	.DRP	.R●50
Double Switch Plate	.DSP	.R●50
Double Vanity Sink Base	.VSB	.P●37
Double Vanity Sink Base w/Four Drawers	.4VSD	.P●37-P●38
Drawer Front Flat 5-piece Inset Modification	.DFF5PCINS	.G●10
Drawer Front Flat 5-piece Modification	.DFF5PC	.G●10

Description	Code	Page Number
Drawer Front Flat 5-piece w/Slab Top Modification	.DFF5PCSLBT	.G●10
Drawer Front Only	.DRWFRTONLY	.H●1
Drawer Front Raised 5-piece Inset Modification	.DFR5PCINS	.G●11
Drawer Front Raised 5-piece Modification	.DFR5PC	.G●11
Drawer Front Raised 5-piece w/Slab Top Modification	.DFR5PCSLBT	.G●11
Drawer Front Slab Modification	.DFSLSB	.G●11
Drawer Front Slab Top Modification	.DFSLSBT	.G●12
Ductless Conversion Kit	.CONVERSION, FILTER	.K●15
Easy Reach Wall Corner	.ER	.J●64
Edgebanding	.BANDVEN	.S●15
End Extended Back Modification	.EXBK	.G●25
End Panels - Full Overlay	.BEPWF.WD, TEP.OF3WD, WEPWF.WD	.Q●15
English Country Car Siding Paneling	.BP.VG	.Q●19
English Country Car Siding Skins	.BEPS..VG, TEPS..VG, VEPS..VG, WEPS..VG	.Q●19
English Country Island Column	.ENGISLCOLUMN	.R●44
English Country Island Quartered Column	.ENGISLQTRCOL	.R●44
English Country Leg	.ENGNTYLEG	.R●37
Entertainment Base	.EB	.O●12
Entertainment Base, No Toekick	.EB..NTK	.O●12
Entertainment Base w/Drawers	.EBDB	.O●14
Entertainment Box Column Filler	.EBCF	.O●15
Entertainment Open Drawer	.EOD	.O●12
Entertainment Platform	.EP	.O●16
Entertainment Stacked Wall	.ESTW	.O●13
Entertainment Topper	.ET	.O●16
Entertainment Wall	.EW	.O●13
Entertainment Wood Tops w/Beveled Edge	.1TWT..BE, 2TWT..BE, 3TWT..BE	.O●16
Entertainment Wood Tops w/Ogee Edge	.1TWT..OG, 2TWT..OG, 3TWT..OG	.O●17
Entertainment Wood Tops w/Round Over Edge	.1TWT..RO, 2TWT..RO, 3TWT..RO	.O●17
Entertainment Wood Tops w/Square Edge	.1TWT..SE, 2TWT..SE, 3TWT..SE	.O●18
Entry Ensemble Drawer Base	.EEDB	.O●3
Entry Ensemble Open Base	.EEOB	.O●4
Entry Ensemble Stacked Wall	.EESTW	.O●6
Entry Ensemble Stacked Wall Message	.EESTWM	.O●7
Entry Ensemble Stacked Wall Open	.EESTWO	.O●5
Entry Ensemble Tall	.EET	.O●3
Estate Leg	.ESTATE	.R●38
Extended Stile w/Overlay Modification	.EXBOL, EXLOL, EXROL	.G●20
Extended Stiles Modification	.EX	.G●21
Face Frame and Door on End Modification	.FFD	.G●26
Finish Kit	.FINKIT	.F●12
Finished Blind Modification	.FBF	.G●21
Finished Bottom Modification	.PFINBTMB	.G●8
Finished Edges - All Modification	.FALL	.G●8
Finished Edges Modification	.FFRT	.G●8
Finished Ends Modification	.FL, FR	.G●8
Floating Shelf	.FS, SHELFIND	.J●91, R●22
Flower Rosette	.ROSETTEFLW	.R●16
Flush Panel End Modification	.FPE	.G●26
Flush Toekick - Arch Modification	.FTKAV	.G●21
Flush Toekick Modification	.FTK	.G●21
Flute Leg	.FLUTELEG	.R●41
Fluted Island Leg	.DISLEGFL	.R●34
Fluting Modification	.FLUT	.G●38
Fluting on Fillers Modification	.FLUT	.G●38
Food Storage Container Organizer Kit	.FSCO..KIT	.S●2
Four Drawer Base	.4DB	.L●24
Four Drawer Base w/Bread Board	.4DB..BB	.L●25
Four Drawer Base w/Charging Drawer	.4DB..CHGDRW	.L●27
Four Drawer Base w/Cutlery Insert Wood Dividers	.4DB..CIW	.L●26
Four Drawer Base w/Wood Tiered Cutlery Divider	.4DB..WTC	.L●25
Four Drawer Base w/Wood Tiered K-Cup Drawer	.4DB..KCUP	.L●26
Four Drawer Entertainment Base	.4EDB	.O●13
Four Drawer Entertainment Base, No Toekick	.4EDB..NTK	.O●14
Frame Rail Material	.FFRAIL	.Q●23
French Country Foot	.FRNCNTYFOOT	.R●31
French Country Leg	.FRNCNTYLEG	.R●38, R●39
French Country Reeded Leg	.FRNCNTYRDLEG	.R●39
French Country Square Leg	.FRNCNTYSQLEG	.R●39
Full Depth Shelf Modification	.FD	.G●39
Full Extension Drawer & Roll Tray Slides	.DGK..FXSPG	.S●15

Description	Code	Page Number
Full Height Base	B..FH	L•12-L•13
Full Height Base Angled Cabinet	BAC..FH	L•86
Full Height Base Corner Full Width	BCFW..FH	L•65
Full Height Base Corner Full Width w/Arched Pull-out	BCFWH..CPO	L•64
Full Height Base Corner Full Width w/Curve Pull-out	BCFWH..CRVPO	L•66
Full Height Base Peninsula	B..FHP	L•81
Full Height Base w/Roll Trays	B..FHRT	L•14-L•15
Full Height Base w/Tray Divider	TD..FH	L•83
Full Overlay Crown Moulding	FOLCROWN	R•3
Furniture Drawer	FD	L•103, L•104
Furniture Drawer Window Bench	FDWB	L•105
Gaelic Leg	GAELICLEG	R•41
Gallery Mullion Door Modification	GAMD	G•14
Glass Shelf Kits	GSK	S•7
Glaze Pen	GLAZEPEN	E•12
Grape Decorative Onlays/Overlays	GROVLY	R•21
Grape Rosette	GRO	R•16
Grommet	EEGRAM	O•8
Hampton Pedestal Foot, Center	HAMPPEDFOOTCTR	R•31
Hampton Pedestal Foot, Corner	HAMPPEDFOOTC	R•31
Hampton Pedestal Foot, Left	HAMPPEDFOOTL	R•31
Hampton Pedestal Foot, Right	HAMPPEDFOOTR	R•31
Hearth Door Front Configurations	H..DF	K•24, K•25
Hearth Liner	HL	K•26
Hearth Mantel	HM	K•23
Hearth Overlay Fillers	HOF	K•26
Hearth Pier	HP	K•22
Hearth Pier Pull-out	HPP	K•23
Hearth Shelf	HS	K•25
Hearth Tower Pull-out Kit	HPPKIT	S•8
Hinge Angle Restriction Clip	HINGERESCLIP	S•15
Hinge Angle Restriction Clip Inset	HINGERESCLIPIN	S•15
Hinge Plates	HINGEISCLPT	S•16
Hinge Restriction Clip	WTH..CLIP	S•16
Hinge Spacers	HNGSPACER	S•14
Hinges	HINGE	S•15
Horizon Door Modification	HCG, HCP	G•15
Hutch Base	HB	L•106
Hutch End Panel	HE	O•20
Increased Depths Modification	ID	G•39
Increased Heights Modification	IH	G•40
Increased Widths Modification	IW	G•46, G•48
Industrial Bracket, Loop	BRACKETIND	R•24
Industrial Bracket, Straight	STBRACKETIND	R•24
Industrial Foot	INDFOOT	R•33
Industrial Shelf	SHELFIND	R•22
Insert Crown Moulding	SWVCRM	R•3
Insert Panel Crown	INSCROWN	R•4
Inset Appliance Panels	IAPPLIANCE	O•30
Inset Door Modification	NOBEAD	G•12
Inset Finial Hinges	HIF	S•16
Inset Finial Hinges Modification	IF	G•12
Inset Magnetic Catches	MAGCATCHINSET	S•15
Inset Panel Ends Modification	IPE	G•27
Inside Corner Moulding	ICM	R•8
Inside Corner Moulding (#2)	ICMA	R•8
Installation Hardware Parts	BRKOFFSCREW, BUMPERPADS	S•16
Integral End Modification	INTGE	G•28
Integrated Panels	DAINTEGRATEDDF, DAINTEGRATEDDR	O•32
Inverted Frame Modification	INVFRM	G•21
Island Leg	SISLLEG	R•36
Island Leg, Square	SQISLLEG	R•36
Jumper Cables	BRIDGECABLE	T•1
Kensington Foot	KENSFOOT	R•31
Kensington Leg	KENSINGLEG	R•39
Keyboard Tray	KBT	O•25
Kit Components for BCOPP	BCOPPKIT	S•3
Kit Components for BTOPP	BTOPPKIT	S•2
Kit Components for BUPP	BUPPKIT	S•2
Kit Components for BUPPKB	BUPPKBKIT	S•2
Kitchen Island Leg	DISLLEG	R•34

Description	Code	Page Number
Lacquar Spray Can	SSC	E•12
Large Batten Moulding	SM..LG	R•8
Large Bijou Corbel	CORBELBIJL	R•27
Large Crown Moulding	SWLCRM	R•3
Large Diamond Weaved Island Column	WEAVELEGL	R•46
Large Grape Shelf Support	LGGRPSUPPORT	R•23
Large Insert Crown	LRCROWN	R•3
Large Outside Corner	LOSC	R•9
Large Scribe Moulding	LSM	R•7
Large Shaker Crown Moulding	LSHAKER	R•3
Large Shelf Support	LGCORBEL	R•23
Large Straight Angle Crown Moulding	LSACROWN	R•3
Large Weaved Corbel	CORBELWEAVEL	R•28
Lazy Susan Base Panel	BLSBEPWD	Q•20
Lazy Susan Kit	BER..SKIT, BLSKIT, BRDB..KIT, DAB..KIT, DWLKIT, SLS..KIT, SLSCR..KIT	S•8
Lazy Susan Pole Kit	LSPOLEKIT	S•8
Lazy Susan Pull-out	LSP	L•78
Lexington Island Pedestal Kit	LEXISLKIT	R•43
Lexington Shelf Strap	LEXSHLFSTRP	R•24
Lexington Table Pedestal Kit	LEXTBLKIT	R•43
L-shaped Organizer	VLSO	G•50
Lid Organizer	LO	S•8
Lid Pull-out Kit	LH..KIT	S•13
Light Baffle	LB	R•5
Light Rail Moulding	LRM	R•5
Lille Fluted Foot	LIFLUTFOOT	R•29
Lille Foot	LIFOOT	R•29
Linen Closet	LC	P•50
Linen Closet w/Removable Hamper	LCRH	P•51
Linen Storage Cabinet	LT	P•51
Madeline Bun Foot	MADEFOOT	R•31
Madeline Post, Large	MADELINEPOSTL	R•37
Madison Foot	MADFOOT	R•31
Matching Interior Modification	MIP	G•9
Medium Straight Angle Crown Moulding	MSACROWN	R•3
Metro Bar Column	METBARCOLUMN	R•45
Metro Island Column	METISLCOLUMN	R•45
Metropolitan Foot	METROFOOT	R•32
Microwave & Single Oven Trimmable Cabinet	OMC	N•27-N•28
Microwave & Single Oven Trimmable Cabinet w/Deep Drawer	OMC..DD	N•29-N•30
Mid-Century Bracket	TRIBRKT	R•23
Mid-Century Foot, Medium	MCFOOTM	R•33
Mid-Century Foot, Short	MCFOOTS	R•32
Mid-Century Foot, Tall	MCFOOTT	R•33
Mid-Century Island Column	MCISLCOLUMN	R•47
Mid-Century Metal Foot	MCMFOOT	R•33
Mid-Century Table Leg	MCLEG	R•42
Mid-Century Vanity Column	MCVANCOLUMN	R•47
Mission Corbel	CORBELMIS	K•26, R•28
Mission Door Modification	MCG, MCP	G•15
Mission Leg	DLEMISSION	R•35
Mission Rosette	ROSETTEMIS	R•16
Mixer Shelf w/Pop-Up Shelf	MIXKIT	S•8
Modern Corner Shelf	MDCCRNSHLF	R•22
Modern Floating Corner Shelf	MDFLCRNSHLF	R•22
Modified Full Overlay Modification	MFO	G•13
Moulding Location Modification	MLDG	G•36
Mullion Door Clips	MDCLIPS	S•14
Mullion Doors Modification	MD	G•16
Natural Material	NAT	Q•20
Natural Veneer	NATVEN	Q•21
Nickel Towel Bar Modification	TBN	G•24
No Hinge Cut Modification	NHC	G•16
Notched Mid-Century Foot, Medium	NMCFEOTM	R•33
Notched Mid-Century Foot, Tall	NMCFEOT	R•33
Notched Mid-Century Island Column	NMCSL COLUMN	R•47
Notched Mid-Century Vanity Column	NMCMVAN COLUMN	R•47
Office & Vanity Fillers	CFB, FBCO, FBCV	O•3
Office & Vanity Overlay Fillers	OFO, OFV	O•9
Office Fillers	FO	O•2

Description Index

Description	Code	Page Number	Description	Code	Page Number
Office Fluted Fillers	.FFO	.Q●5	Recessed Vanity Wall Modification	.REC	.G●22
Ogee Moulding	.OGEEM	.R●6	Reduced Depths Modification	.RD	.G●39
Old World Bracket	.BRACKETOWD	.R●24	Reduced Heights Modification	.RH	.G●40
Old World Corbel	.CORBELOWD	.K●26, R●28	Reduced Widths Modification	.RW	.G●49
Old World Corbel w/Strap	.CORBELOWDSTR	.K●26, R●28	Reed Leg	.RDLEG	.R●34
Open Bottom Rail Base Modification	.OBRB	.G●22	Refrigerator Panel	.TEP	.Q●16-Q●18
Outside 135° Corner Moulding	.OC	.R●8	Retainer Clips	.RETAINER	.S●14
Outside Corner Moulding	.OCM	.R●8	Roll Tray Bottom w/Full Depth Shelf Modification	.FDSRTBTM	.G●31
Oven Microwave Trimmable Cabinet	.TBMWB	.N●20-N●21	Roll Tray Bumper Pads	.BUMPERTT	.S●15
Overlay Fillers	.OFBC	.Q●10	Roll Tray Kit	.DGK..FXSRTPG, RT..SP	.S●9
Overlay Panels	.DAOVERLAY	.Q●34	Roll Trays Modification	.RT	.G●32
Overlay Valance	.OSV	.R●21	Rope Island Leg	.DISLEGRP	.R●35
Pacific Rim Create A Column	.PRCCOLUMN	.R●47	Rope Leg	.RDLLEG	.R●40
Pacific Rim Island Column	.PRISLCOLUMN	.R●47	Rope Moulding	.RPM	.R●6
Pacific Rim Leg	.PRLEG	.R●42	Rose Fluting Modification	.ROSFLUT	.G●50
Palladian Corbel	.CORBELPALLA	.R●25	Rose Fluting on Fillers Modification	.ROSFLUT	.G●50
Paneling	.BP, WP	.Q●19	Round Base	.ROUNDBASE	.R●44
Pantry Unit	.PY	.M●29-M●30	Round Countertop Moulding	.RCTM	.R●7
Peaked Large Rosette	.ROSETTELGPK	.R●16	Rustic Corner Shelf	.RSTCCRNSHLF	.R●21
Peaked Small Rosette	.ROSETTESMPK	.R●16	Rustic Floating Corner Shelf	.RSTCFITCRNSHLF	.R●22
Pedestal Foot - Corner	.PEDFOOTC	.R●29	Scooped Drawers Modification	.SCPDRAW	.G●32
Pedestal Foot - No Return Left	.PEDFOOTL	.R●29	Scooped Roll Tray Kit	.SRT..SP	.S●10
Pedestal Foot - No Return Right	.PEDFOOTR	.R●30	Scooped Roll Tray Modification	.SRT	.G●32
Pedestal Foot - Return Left	.PEDFOOTRETL	.R●30	Secured Drawer featuring Master Lock Biometric Technology Modification	.DRWSEC	.G●51
Pedestal Foot - Return Right	.PEDFOOTRETR	.R●30	Shaker Corbel	.CORBELSHKR	.R●27
Pegged Dish Organizer	.PDO, PDOPOSTS	.S●8	Shaker Crown Moulding	.SHKRCRM	.R●3
Petite Acanthus Corbel	.CORBELACANS	.R●27	Shaker Mullion Door Modification	.SHMD	.G●16
Pilasters	.PIL	.Q●24, Q●25	Shelving Material	.SHELF	.Q●22
Pinnacle Corbel	.CORBELPINN	.R●27	Shoe Convex Inside Corner Moulding	.SHM	.R●8
Pinnacle Rosette	.ROSETTEPINN	.R●21	Simplicity Crown	.SIMCROWN	.R●2
Plain Nouveau Bar Column	.NOULEGT	.R●45	Single Bead Edge	.SBE	.R●6
Plain Nouveau Island Column	.NOULEG	.R●45	Single Bead Moulding	.SBM	.R●6
Plain Nouveau Large Corbel	.CORBELNOUL	.R●27	Single Hook Black	.EEHSB	.O●8
Plain Nouveau Medium Corbel	.CORBELNOUM	.R●28	Single Hook Nickel	.EEHSN	.O●8
Plain Nouveau Small Corbel	.CORBELNOUS	.R●28	Single Outlet Cover	.SOC	.R●50
Plastic Shelf Clips	.SHELFPEGS	.S●14	Single Oven Trimmable Cabinet	.OCS	.N●43-N●44
Plastic Storage Bins	.PSBKIT	.S●8	Single Oven Trimmable Cabinet w/Deep Drawer	.OCS..DD	.N●45-N●46
Position Bridge on Bottom of Wall Cabinet	.BRIDGE.BTM	.T●2	Single Oven Trimmable Cabinet w/Drawers	.OCS.D	.N●37-N●38
Position Bridge on Top of Wall Cabinet	.BRIDGE.TOP	.T●2	Single Panel Tall Door Modification	.SGLPN	.G●13
Pots & Pans Pull-out Kit	.PPH..KIT, PPP..KIT	.S●9, S●13	Single Rocker Plate	.SRP	.R●50
Power Bridge	.3ZONEPWRBRD	.T●1	Single Switch Plate	.SSP	.R●50
Power Pod	.PWRPOD	.S●11	Sink Base	.SB	.L●38, L●43
Power Strip	.EEPWR	.O●8	Sink Base Cleaning Caddy	.SBCADDY, SBCADDYSM	.S●14
Prairie Mullion Doors Modification	.PRMD	.G●16	Sink Base Cleaning Caddy Modification	.SBCADDY	.G●51
Premium Door Mechanism	.PDM	.S●16	Sink Base Cleaning Caddy Small Modification	.SBCADDYSM	.G●51
Profile Edge Moulding	.SHAPE	.R●7	Sink Base Double Door w/CabMat	.SB..CM	.L●39
Profiled and Finished Edges - All Modification	.PRO.ALL	.G●9	Sink Base Double Door w/Caddy	.SB..CDY	.L●39
Profiled and Finished Edges Modification	.PRO	.G●9	Sink Base SuperCabinet	.SB..S	.L●45
Push-to-Open Wastebasket Modification	.PTOWB	.G●13	Sink Base SuperCabinet w/CabMat	.SB..SCM	.L●46
Quart of Glaze	.GLAZEQUART	.E●12	Sink Base SuperCabinet w/Caddy	.SB..SCDY	.L●45
Quart of Paint	.PAINTQUART	.E●12	Sink Base SuperCabinet w/Tilt-out Tray	.SB..STS	.L●46
Quart of Stain	.STAINQUART	.E●12	Sink Base SuperCabinet w/Tilt-out Tray & Caddy	.SB..STSCDY	.L●47
Quart of Toner	.TONERQUART	.E●12	Sink Base SuperCabinet w/Tilt-out Trays & CabMat	.SB..STSCM	.L●47
Quarter Round Moulding	.QRM	.R●8	Sink Base w/Drawer Below	.SB..D	.L●50
Queen Anne Buffet Column	.QALEGT	.R●46	Sink Base w/Tilt-out Tray	.SB..ST	.L●40-L●41, L●44
Queen Anne Corner Acanthus Leg	.QACRNACALEG	.R●40	Sink Base w/Tilt-out Tray & Caddy	.SB..STCDY	.L●42
Queen Anne Corner Fluted Leg	.QACRNRFUTLEG	.R●40	Sink Base w/Tilt-out Trays & CabMat	.SB..STCM	.L●42
Queen Anne Corner Leg	.QACRNLEG	.R●40	Sink Front	.SF	.L●51, L●52
Queen Anne Foot	.QAFOOT	.R●32	Sink Front Bottom	.SFB	.L●52
Queen Anne Leg	.FRNLG	.R●40	Six Drawer Base	.6DB	.L●24
Queen Anne Scroll Foot	.QASCROLLFOOT	.R●32	Six Drawer Entertainment Base, No Toekick	.6EDB	.O●14
Raised Panel Valance	.RPV	.R●18	Skins	.BEPS, TEPS, VEPS, WEPS	.Q●18
Range Hood Stainless Steel Square	.RHSS	.K●13	Sliding Towel Bar	.STR	.S●10
Range Hood Stainless Steel Tapered	.RHST	.K●13	Small Acanthus Corbel	.CORBELACAN	.R●27
Range Panel	.DRP	.L●58	Small Batten Moulding	.SM	.R●8
Range Platform w/Drawers	.R..PD	.L●58	Small Bijou Corbel	.CORBELBIJS	.R●27
Recessed Panel Valance	.RCPV	.R●18	Small Cove Crown Moulding	.SMCOVECROWN	.R●2
Recessed Toekick - 6" Modification	.RECTK_6	.G●29	Small Gaelic Rosette	.ROSETTEGAE	.R●16
Recessed Toekick Front - 6" Modification	.RECTKFR6	.G●30	Small Grape Shelf Support	.SMGRPSSUPPORT	.R●23
Recessed Toekick Front Modification	.RECTKFR	.G●30	Small Light Rail Moulding	.SMLR	.R●5
Recessed Toekick Modification	.RECTK	.G●29			

Description Index

Description	Code	Page Number
Small Scribe Moulding	SSM	R●7
Small Shelf Support	SMCORBEL	R●23
Small Weaved Corbel	CORBELWEAVES	R●28
Soffit Filler Moulding	SFM	R●2
Soffit Scribe Crown Moulding	SCM	R●4
Soffit Trim Moulding	STM	R●5
Solid Wood	SOLID	Q●22
Solid Wood Tall Crown Moulding	SWTCRM	R●4
Spice Drawer	SD	S●10
Spice Pull-out	SPICE.PG	S●10
Split Doors Modification	SPLITDR	G●13
Split Drawers Modification	SPLITDRWS	G●13
Split Turning Acanthus	3SPRINGACA	R●17
Split Turning Block	3SPRINGBLK	R●17
Split Turning Capital	3SPRINGCAP	R●17
Split Turning Center	3SPRINGCTR	R●16
Split Turning Spindle	3SPRINGSPNDL	R●17
Split Turning Systems End	SPRINGEND	R●17
Split Turning Systems Reed	SPRINGREED	R●17
Split Turning Systems Rope	SPRINGROPE	R●17
Split Turning Systems Spool	SPRINGSPPOOL	R●18
Split Turning Weaved	3SPRINGWV	R●17
Spool Leg	SPLG	R●34
Square Foot	SMSQFOOT	Q●15, R●29
Square Island Leg	DISLEGSQ	R●35
Square Leg w/Sleeve	SQLEG	R●42, R●43
Stack Moulding Kits	STKMLD	R●10-R●15
Stacked Wall	STW	J●28-J●35
Stacked Wall Cabinet Heights Modification	STW	G●22
Stacked Wall End Cabinet Double Door	STWEC.D	J●41
Stacked Wall End Cabinet Single Door	STWEC	J●42
Stacked Wall Transition Cabinet	STWTC	J●43, J●44
Stacked Wall w/Appliance Garage	STWDAG	J●24-J●27
Stacked Wall w/Vertical-Hift	STWAG	J●36-J●39
Stainless Hood Filter	KF	R●13
Standard Drivers	STAND	T●1
Starter Moulding	STR	R●2
Starter Shaker Moulding	STRS	R●2
Stem Bumper Pads	BUMPERSTEM	S●14
Stem Glass Holder	WGH	S●10
Storage Open Rail Base Modification	STORB	G●22
Straight Angle Crown Moulding	SACROWN	R●3
Straight Valance	VV	R●19
Stretcher Material	STRETCHERMAT	Q●22
Summit Foot	SUMFOOT	R●30
Sumter Island Column, Double Square	DBLSQSUMTER	R●48
Sumter Table Column, Double Square	DBLSQTBL	R●48
Super Lazy Susan	SLSW	L●74
Super Lazy Susan w/Chrome Rail	SLSCR	L●76
Super Lazy Susan w/Chrome Rail & Corner Drawer	SLSCR.CD	L●77
Super Lazy Susan w/Chrome Rail & Reduced Shelf	SLSCR.RS	L●72
Tablet Holder	TABLETHLDR	S●11
Tall Bookcase w/Arched Valance	T.BCAV	Q●29-Q●31
Tall Bookcase w/Doors & Arched Valance	TD.BCAV	Q●32-Q●34
Tall Bookcase w/Office Height Doors & Arched Valance	TDO.BCAV	Q●38-Q●40
Tall Bookcase w/Vanity Height Doors & Arched Valance	TDV.BCAV	Q●35-Q●37
Tall Built-in Microwave Cabinet	OCM.AC	N●17-N●19
Tall Crown Moulding	MTCROWN, TCROWN, TLCROWN	R●4
Tall Fluted Fillers	FF, TF	Q●5
Tall Pantry Pull-out	TPP	M●26-M●28
Tapered 4-Sided Leg	T4SLEG	R●30
Tapered Leg	TAPLG, TLEG	R●30
Tapered Vanity End Panel	VDL213OWD	Q●20
Tapered Wood Hood	TWH	K●12
Three Corner Drawer Base	3CDB	L●78
Three Drawer Base	3DB	L●27-L●28
Three Drawer Base Buffet	3DBB	L●28
Three Drawer Base Buffet w/Deep Drawer	3DBBDD	L●31
Three Drawer Base, Warming Drawer	3DB.WD	M●11
Three Drawer Base w/Bread Board	3DB.BB	L●30
Three Drawer Base w/Charging Drawer	3DB.CHGDRW	L●31

Description	Code	Page Number
Three Drawer Base w/Deep Drawer	3DBDD	L●29
Three Drawer Base w/Wood Tiered Cutlery Divider	3DB.WTCD	L●29
Three Drawer Base w/Wood Tiered K-Cup Drawer	3DB.KCUP	L●30
Tilt-out Tray(s) Stainless Steel	TOTSSS	S●6
Toe Board Trim	TB8WD	Q●19
Toekick Caps	TKC	Q●19
Toekick Drawer Modification	DRWTK	G●30
Toekick Pedestal Modification	TKP	G●30
Toekick Tulip Foot	TKTLFOOT	R●29
Top Valance Rail Modification	TVR	G●23
Touch-up Kit	TUK	E●12
Traditional Batten Moulding	TBATM	R●8
Traditional Light Rail	TLR	R●5
Traditional Light Rail Moulding	JINSERTLRT	R●5
Traditional Open Corbel	CORBELTRADO	R●27
Traditional Rosette	TROSETTE	R●16
Traditional Soffit Trim Moulding	TSTM	R●4
Traditional Window Casing	WCT	R●9
Transom Doors Modification	TCG, TCP	G●17
Tray Divider	TDKIT	S●10
Tray Divider Modification	TD	G●52
Tray Divider Roll-out	TDR, TDROHDWONLY	S●10
Triad Corbel	CORBELTRIAD	R●26
Triad Rosette	ROSETTETRIAD	R●21
Trim Moulding	TM	R●4
Triple Bead Moulding	TBEAM	R●6
Tulip Foot	TLFOOT	R●29
Tulip Foot Square	FOOTULIPSQ	R●29
Turnbuckles for False Drawer Fronts	FALSEPANELCLIP	S●15
Two Drawer Base	2DB	L●32, L●34
Two Drawer Base Corner Full Width w/Curve Pull-out	BCFW2D..CRVPO	L●66
Two Drawer Base w/Pegged Dish Organizer	2DB.PDO	L●32
Two Drawer Base w/Reduced Drawers, Drop-in Range	2DB.RDR	L●56
Two Drawer Base w/Roll Tray & Pegged Dish Organizer	2DB.RTPDO	L●33
Two Drawer Base w/Roll Trays	2DB.RT	L●33
Two Drawer Base, Drop-in Range	2DB.DR	L●55
Under Counter Drawer	UCD	P●46
Under Counter Drawer, Trimmable	UCD.T	P●46
Urban Island Column	URBISLCOLUMN	R●46
U-shaped Deep Roll Tray Kit	UDRT.SP	S●7
U-shaped Drawer Box Modification	UDBX	G●33
U-shaped Roll Tray Kit	URT.SP	S●7
U-shaped Roll Tray Modification	URT	G●34
Utility	U	M●3-M●15
Utility Fillers	UF	Q●3
Utility Inverted	UI	M●20-M●21
Utility Organizer Cabinet	UOC	M●31-M●38
Utility Organizer Drop Zone Cabinet	UOCDZ	M●39-M●40
Utility Organizer Drop Zone Cabinet w/Authentic End	UOCDZ.AE	M●41
Utility Overlay Fillers	OL	Q●9
Utility w/Four Drawers	U4D	M●18, M●19
Utility w/Roll Trays	U.RT	M●21-M●25
Utility w/Three Drawers	U3D	M●16, M●17
Valances	V	R●19-R●20
Valley Forge Moulding	VFR	R●5
Vanity Angled Corner Sink Front	VACSF	P●45
Vanity Base, Double Door w/Drawer	VB	P●8
Vanity Base Pull-out	VBP	P●13
Vanity Base Pull-out Kit	VBPKIT	S●11
Vanity Base, Single Door w/Drawer	VB	P●7
Vanity Base Single Door w/Shelf	V.S	P●9
Vanity Base Single Door without Shelf	V	P●11
Vanity Base w/Shelf	V.S	P●10
Vanity Base without Shelf	MV, V	P●12, P●13
Vanity Combination Drawer Base w/Four Drawers	4VCDB.D	P●29
Vanity Combination Drawer Base w/Three Drawers	V.CDB.D	P●28
Vanity Console Drawer Base w/Eight Drawers	4-6VCDB	P●31
Vanity Console Drawer Base w/Six Drawers	6VCDB	P●30
Vanity Console Drawer Base w/Six Drawers & Wood Tiered Vanity Drawer	6VSDB.WTV	P●36
Vanity Fillers	FV	Q●2

Description Index

Description	Code	Page Number	Description	Code	Page Number
Vanity Fluted FillersFFVQ05	Wall Wine Storage CabinetWSC	J094
Vanity Four Drawer Base4VDB	P044-P045	Wall w/Three DrawersW3D	J022-J023
Vanity Hamper Base CabinetVH..FH	P038	Wall w/Two DrawersW2D	J020-J021
Vanity MirrorVM	P05	Wastebasket AssemblyBWB..FHKIT, BWB..KIT	S011, S012
Vanity Recessed CabinetVWR	P04	Wastebasket OnlyWASTEBIN	S012
Vanity Sink & Hamper Drawer BaseVSHDB..D	P039	Water ClosetWCT	P06
Vanity Sink & Hamper Drawer Base w/Four Drawers4VSHDB..D	P040	Weaved Bun FootWEAVEBUNFOOT	R032
Vanity Sink & Two Drawer Base w/Extended Stiles2VSD..FP	P020	Weaved Island ColumnWEAVELEG	R046
Vanity Sink Base SuperCabinet w/Tilt-out TraysVSSB..ST	P018	Wide Scribe MouldingWSCRIBE	R07
Vanity Sink Base w/False PanelVSB	P014-P017	Wide Stiles ModificationWS	G024
Vanity Sink Base w/Three DrawersVS3D	P025	Wide Top Rail ModificationWTR	G024
Vanity Sink Base w/U-shaped Roll TraysVSB..U	P017	Wine Cube HorizontalW	J096
Vanity Sink Drawer Base2VSD, 2VSD..FP	P019	Wine Cube VerticalWCV	J096
Vanity Sink Drawer Base w/Eight Drawers & False Panel8VSD..FP	P034-P035	Wood Hood Arch Flat PanelWHAFP	K03
Vanity Sink Drawer Base w/False PanelVSD..FP	P021-P022	Wood Hood Artisan StraightWHAS	K012
Vanity Sink Drawer Base w/Four Drawers & False Panel4VSD..FPD	P026-P027	Wood Hood BlowerBLOWER, TWHBLOWER	K014
Vanity Sink Drawer Base w/Six Drawers6VSD..FP	P032-P033	Wood Hood Canopy ArchedWHCA	K05
Vanity Sink Drawer Base w/Three Drawers & False PanelVCSA..FP	P023-P024	Wood Hood Canopy SquareWHCS	K06
Vanity Sink FrontVSF	P041	Wood Hood LinearJWHL	K012
Vanity Three Drawer BaseVDB	P042-P043	Wood Hood Nantucket ArchWHNA	K08
Vanity UtilityUV	P047-P049	Wood Hood Nantucket ChimneyWHNC	K08
Vanity Utility w/DrawersVUD	P050	Wood Hood Nantucket StraightWHNS	K08
Vanity WallW	P03, P04	Wood Hood Shiplap StraightJWHSHPSTR	K09
Vanity Wall Recessed CabinetVWR	P05	Wood Hood Shiplap Straight w/CorbelsJWHSHPSTRCB	K09
Vanity Wastebasket ContainerVWB	G052	Wood Hood Shiplap TaperedJWHSHPST	K010
VeneerVEN	Q021	Wood Hood Shiplap Tapered ChimneyJWHSHPCH	K010
Victorian Countertop SupportVSBS	R023	Wood Hood Shiplap Tapered w/CorbelsJWHSHPSTCB	K010
Void Toe Kick ModificationVTK	G030	Wood Hood Simple ChimneyWHSAC	K011
WainscotingWAIN	Q027	Wood Hood Simple TaperedWHSMT	K011
WallW	J03-J019	Wood Hood Simple Tapered w/CorbelsWHSMTCB	K011
Wall & Base FillersFB, FW	Q03	Wood Hood Square Flat PanelWHSFP	K04
Wall BaseWB	L023	Wood Hood Straight Batten - ProfiledWHSBATTEN	K07
Wall, Base, Office, & Vanity 135° Overlay Fillers135OF	Q010	Wood Tiered Cutlery Divider Drawer ModificationWTCD	G052
Wall Bookcase w/Arched ValanceW..BCAV	Q026-Q028	Wood Tiered Cutlery Divider Drawer w/Installation HardwareWTCD	S05
Wall Box Column Pull-out w/K-CupWBCKCUP	J0105	Wood Tiered K-Cup Drawer ModificationWTKCUP	G052
Wall Box Column Pull-out, OverlayWBCPO..OL	J0104	Wood Tiered K-Cup Drawer w/Installation HardwareKCUP	S06
Wall Box Column Pull-out, PlainWBCPO	J0103	Wood Tiered Vanity Drawer KitWTVD	S06
Wall Built-in Microwave Double Door CabinetWBMW, WBMW..AC	N05-N010	Wood Top, Four Sided4TWT	Q07
Wall Cabinet w/Wine RackWWR	J092	Wood Top, One Sided1TWT	Q06
Wall China DisplayWCD	J095	Wood Top, Three Sided3TWT	Q06
Wall Corner Double DoorWC	J055-J063	Wood TopsWOODTOP	Q06
Wall Corner Single DoorWC	J052-J062	Wood Tops for Angled & Base End Cabinets - Beveled EdgeWTOPBAC..BE	Q07
Wall Easy Access Storage CabinetWEAS	J013	Wood Tops for Angled & Base End Cabinets - Ogee EdgeWTOPBAC..OG	Q07
Wall End and Back Extended Down ModificationEXDN	G028	Wood Tops for Angled & Base End Cabinets - Round OverWTOPBAC..RO	Q08
Wall End Cabinet Double DoorWEC..D	J086	Wood Tops for Angled & Base End Cabinets - Square EdgeWTOPBAC..SE	Q08
Wall End Cabinet Single DoorWEC	J087	X-End PanelXEND	R050
Wall End PanelWEPF	Q013			
Wall FillersF	Q02			
Wall Fluted FillersFF	Q04			
Wall Message CenterWMC	J090			
Wall Microwave CabinetMW	N03			
Wall Microwave Double Door CabinetMW	N04-N08			
Wall Open Cabinet w/Car Siding BackWOCB	J051			
Wall Open Cabinet w/Plain BackWOC	J050			
Wall OrganizerWOR	J091			
Wall Organizer & BookshelfW OBS	J092			
Wall Overlay FillersOL	Q08			
Wall PeninsulaW..P	J074-J077			
Wall Quarter Round End ShelfWQRES	J098-J0101			
Wall RefrigeratorW	J045-J048			
Wall Refrigerator Pull-out CabinetW..PO	J049			
Wall Spice Drawer HorizontalWSD	J097			
Wall Spice Drawer VerticalWSDV	J097			
Wall Spice Pull-out CabinetWSP	J0101			
Wall Spice Pull-out KitWSPKIT	S011			
Wall Spice Rack CabinetWSRC	J0102			
Wall Top Hinge w/BifoldWTH..BF	J015			
Wall Top Hinge w/Stay LiftWTH..SL	J09			
Wall Top Hinge w/Vertical-lift & Stay LiftWVL	J05-J06			
Wall Transition CabinetWTC	J040			
Wall Wine RackWNR	J093			

Contents By Code

Code	Description	Page Number	Code	Description	Page Number
1350F	Wall, Base, Office, & Vanity 135° Overlay Fillers	Q•10	ABBEYCORINSS	Abbey Corbel Insert - Small	R•28
1TWT	Wood Top, One Sided	Q•6	ABBEYINS	Abbey Crown Insert	R•7
1TWT.BE	Entertainment Wood Tops w/Beveled Edge	Q•16	ABBEYINSS	Abbey Light Rail Insert	R•7
1TWT.OG	Entertainment Wood Tops w/Ogee Edge	Q•17	ACANFOOT	Acanthus Foot	R•30
1TWT.RO	Entertainment Wood Tops w/Round Over Edge	Q•17	ACANTHUSLEG	Acanthus Leg	R•41
1TWT.SE	Entertainment Wood Tops w/Square Edge	Q•18	ACCNAIL	Accessory Nail	R•16
2DB	Two Drawer Base	L•32, L•34	ACO	Acanthus Decorative Ornaments	R•21
2DB.DR	Two Drawer Base, Drop-in Range	L•55	ACOVLY	Acanthus Decorative Onlays/Overlays	R•21
2DB.PDO	Two Drawer Base w/Pegged Dish Organizer	L•32	ACS	Angled Corner Sink Base	L•53
2DB.RDR	Two Drawer Base w/Reduced Drawers, Drop-in Range	L•56	ACS.ST	Angled Corner Sink Base w/Tilt-out Tray	L•54
2DB.RT	Two Drawer Base w/Roll Trays	L•33	ACSF	Angled Corner Sink Front	L•55
2DB.RTPDO	Two Drawer Base w/Roll Tray & Pegged Dish Organizer	L•33	ACSF.B	Angled Corner Sink Front Bottom	L•52
2TWT.BE	Entertainment Wood Tops w/Beveled Edge	Q•16	ADD.SHLF	Add Shelf Modification	G•37
2TWT.OG	Entertainment Wood Tops w/Ogee Edge	Q•17	ADDTK	Add Toekick Modification	G•29
2TWT.RO	Entertainment Wood Tops w/Round Over Edge	Q•17	ADRW	Add Drawer Below Wall Unit Modification	G•18
2TWT.SE	Entertainment Wood Tops w/Square Edge	Q•18	AEW	Angled End Wall Cabinet Double Door	J•80, J•84
2VSD	Vanity Sink Drawer Base	P•19	AEW	Angled End Wall Cabinet Single Door	J•78, J•82
2VSD.FP	Vanity Sink & Two Drawer Base w/Extended Stiles	P•20	AEWFFD	Angled End Wall Cabinet Double Door w/Face Frame & Door on End	J•81, J•85
2VSD.FP	Vanity Sink Drawer Base	P•19	AEWFFD	Angled End Wall Cabinet Single Door w/Face Frame & Door on End	J•79, J•83
3CDB	Three Corner Drawer Base	L•78	AF	Aluminum Door Modification	G•14
3DB	Three Drawer Base	L•27-L•28	AOMACTSWITCH	Automatic Opening Mechanism Activation Switch	S•13
3DB.BB	Three Drawer Base w/Bread Board	L•30	AOMBWB	Automatic Opening Mechanism for Wastebaskets Modification	G•9
3DB.CHGDRW	Three Drawer Base w/Charging Drawer	L•31	AOMCABLE	Automatic Opening Mechanism Universal Cable	S•13
3DB.KCUP	Three Drawer Base w/Wood Tiered K-Cup Drawer	L•30	AOMCABLECLIP	Automatic Opening Mechanism Cable Clip	S•13
3DB.WD	Three Drawer Base, Warming Drawer	N•11	AOMCABLECONN	Automatic Opening Mechanism Cable Connector	S•13
3DB.WTCD	Three Drawer Base w/Wood Tiered Cutlery Divider	L•29	AOMCABLEPROT	Automatic Opening Mechanism Cable End Protector	S•13
3DBB	Three Drawer Base Buffet	L•28	AOMD	Automatic Opening Mechanism for Lift Up Systems Modification	G•9
3DBBDD	Three Drawer Base Buffet w/Deep Drawer	L•31	APEXLEG	Apex Leg	R•41
3DBDD	Three Drawer Base w/Deep Drawer	L•29	APEXSTRP	Corner Strap	R•24
3SPRINGACA	Split Turning Acanthus	R•17	ASTM	Angled Soffit Trim Moulding	R•5
3SPRINGBLK	Split Turning Block	R•17	ATTK	Attach Toekick Modification	G•29
3SPRINGCAP	Split Turning Capital	R•17	AUTH	Authentic Flush End Modification	G•25
3SPRINGCTR	Split Turning Center	R•16	AV	Arch Valance	R•18
3SPRINGSPNDL	Split Turning Spindle	R•17	B	Base	L•3
3SPRINGWV	Split Turning Weaved	R•17	B.B	Base Buffet	L•4
3TWT	Wood Top, Three Sided	Q•6	B.BB	Base w/Bread Board	L•4
3TWT.BE	Entertainment Wood Tops w/Beveled Edge	Q•16	B.BCFP	Box Column Fillers, Base	Q•11
3TWT.OG	Entertainment Wood Tops w/Ogee Edge	Q•17	B.CHGDRW	Base w/Charging Drawer	L•5
3TWT.RO	Entertainment Wood Tops w/Round Over Edge	Q•17	B.CHGDRWRT	Base w/Roll Trays & Charging Drawer	L•7
3TWT.SE	Entertainment Wood Tops w/Square Edge	Q•18	B.CIW	Base w/Cutlery Insert Wood Dividers	L•9
3ZONEPWRBRDG	Power Bridge	T•1	B.DR	Base, Drop-in Range	L•56
4-6VCDB	Vanity Console Drawer Base w/Eight Drawers	P•31	B.FH	Full Height Base	L•12-L•13
4DB	Four Drawer Base	L•24	B.FHMXSC	Base w/Mixer Shelf	L•89
4DB.BB	Four Drawer Base w/Bread Board	L•25	B.FHP	Full Height Base Peninsula	L•81
4DB.CHGDRW	Four Drawer Base w/Charging Drawer	L•27	B.FHRT	Full Height Base w/Roll Trays	L•4-L•15
4DB.CIW	Four Drawer Base w/Cutlery Insert Wood Dividers	L•26	B.FSCO	Base w/Food Storage Container Organizer	L•11
4DB.KCUP	Four Drawer Base w/Wood Tiered K-Cup Drawer	L•26	B.KCUP	Base w/Wood Tiered K-Cup Drawer	L•10
4DB.WTCD	Four Drawer Base w/Wood Tiered Cutlery Divider	L•25	B.KCUPRT	Base w/Wood Tiered K-Cup Drawer & Roll Trays	L•11
4EDB	Four Drawer Entertainment Base	Q•13	B.P	Base Peninsula	L•80
4EDB.NTK	Four Drawer Entertainment Base, No Toekick	Q•14	B.PSB	Base w/Plastic Storage Bins	L•89
4TWT	Wood Top, Four Sided	Q•7	B.RRTDR	Base w/Roll Trays, Drop-in Range	L•57
4VCDB.D	Vanity Combination Drawer Base w/Four Drawers	P•29	B.RT	Base w/Roll Trays	L•6
4VDB	Vanity Four Drawer Base	P•44-P•45	B.RTB	Base Buffet w/Roll Trays	L•20
4VSD	Double Vanity Sink Base w/Four Drawers	P•37-P•38	B.RTCIW	Base w/Cutlery Insert Wood Dividers & Roll Trays	L•10
4VSD.FPD	Vanity Sink Drawer Base w/Four Drawers & False Panel	P•26-P•27	B.RTDR	Base w/Reduced Depth Roll Trays, Drop-in Range	L•57
4VSHDB.D	Vanity Sink & Hamper Drawer Base w/Four Drawers	P•40	B.RTLO	Base w/Drawer & Lid Organizer & Roll Trays	L•36
4ZONECON	4 Zone Wall Controller	T•1	B.RTWCD	Base w/Wood Tiered Cutlery Divider & Roll Trays	L•8
4ZONEDIMREC	4 Zone Dimming Receiver	T•1	B.SD	Base w/Spice Drawer	L•94
6DB	Six Drawer Base	L•24	B.SDI	Base Sliding Door Island Cabinet	L•79
6EDB	Six Drawer Entertainment Base, No Toekick	Q•14	B.SDIDSK	Base Sliding Door Island Cabinet w/Sliding Desk	L•79
6VCDB	Vanity Console Drawer Base w/Six Drawers	P•30	B.TDRO	Base w/Roll-out Tray Divider	L•84
6VSD.FP	Vanity Sink Drawer Base w/Six Drawers	P•32-P•33	B.WTCD	Base w/Wood Tiered Cutlery Divider	L•7
6VSDB.WTV	Vanity Console Drawer Base w/Six Drawers & Wood Tiered Vanity Drawer	P•36	B2D	Base w/Two Split Drawers	L•16
8VSD.FP	Vanity Sink Drawer Base w/Eight Drawers & False Panel	P•34-P•35	B2D.RT	Base w/Two Split Drawers & Roll Tray	L•17
ABBEYCOLINS	Abbey Column Insert - Island	R•49	B4D	Base Double Door w/Four Split Drawers	L•18-L•19
ABBEYCOLINST	Abbey Column Insert - Bar	R•49	B4D.RT	Base Double Door w/Four Split Drawers & Roll Tray	L•18
ABBEYCORINSL	Abbey Corbel Insert - Large	R•28	B4D.RT	Base Double Door w/Four Split Drawers & Roll Trays	L•19
ABBEYCORINSM	Abbey Corbel Insert - Medium	R•28	BAC	Base Angled Cabinet	L•86

Code Index

Code	Description	Page Number
BAC..FH	.Full Height Base Angled Cabinet	L●86
BANDVEN	.Edgebanding	S●15
BARISLCOLUMN	.Baroque Column	R●45
BARV.	.Baroque Valance	R●18
BASKET	.Base Open Basket Kits	S●3
BBCPO.	.Base Box Column Pull-out, Plain	L●90
BBCPO..OL	.Base Box Column Pull-out, Overlay	L●91
BBM	.Decorative Baseboard Moulding	R●9
BBMSC	.Baseboard Moulding Sculpted	R●9
BBMSH	.Baseboard Moulding Shaker	R●9
BBMWD	.Base Built-in Microwave Cabinet w/Drawer	N●13
BBOARDKIT	.Bread Board	S●3
BBS	.Base w/Bottle Storage	L●101
BBSKIT18	.Base Bottle Storage Kit	S●2
BC	.Base Corner	L●59
BC..PO	.Base Corner Pull-out	L●61
BC2DB	.Bath Two Drawer Sink Base	P●59
BCB..NTK	.Bath Base Cabinet	P●53
BCBCD	.Bath Sink Base Cabinet w/Doors	P●55
BCBCO	.Bath Sink Base Cabinet w/Shelf	P●54
BCBDT..NTK	.Bath Drop Tray Sink Base	P●60
BCBH..D	.Bath Hamper Sink Base	P●56
BCC..BB	.Base Cooking Center w/Bread Board	L●37
BCCWM	.Bath Channel Wall Mirror	P●66
BCD	.Base Combination Drawer Cabinet	L●36
BCDB	.Bath Drawer Sink Base	P●59
BCDRW	.Bath Drawer Sink Vanity	P●60
BCFW	.Base Corner Full Width	L●60
BCFW..CPO	.Base Corner Full Width w/Arched Pull-out	L●63
BCFW..FH	.Full Height Base Corner Full Width	L●65
BCFW..P	.Base Corner Full Width Peninsula	L●67
BCFW..PO	.Base Corner Full Width Pull-out	L●62
BCFW..SP	.Base Corner Full Width w/Roll Trays & Swing-out	L●63
BCFW2D..CRVPO	.Two Drawer Base Corner Full Width w/Curve Pull-out	L●66
BCFWFH..CPO	.Full Height Base Corner Full Width w/Arched Pull-out	L●64
BCFWFH..CRVPO	.Full Height Base Corner Full Width w/Curve Pull-out	L●66
BCFWM	.Bath Framed Wall Mirror	P●66
BCOPP	.Base Container Organization Pantry	L●94
BCOPPKIT	.Kit Components for BCOPP	S●3
BCP	.Base Corner Peninsula	L●82
BCPLATFORM	.Bath Drawer Sink Vanity Platform	P●60
BCST	.Bath Storage Tower	P●61
BCSTDRW	.Bath Storage Tower Double Drawer	P●64
BCSTDRW	.Bath Storage Tower Single Drawer	P●62-P●63
BCTT	.Bath Tank Topper	P●65
BCTTOS	.Bath Tank Topper Open Shelf	P●65
BCWHC	.Bath Wall Hung Sink Console	P●52
BCWHDB	.Bath Wall Hung Sink Drawer Base	P●56-P●57
BCWHDBPO..D	.Bath Wall Hung Sink w/Grooming Pull-out	P●58
BCWT	.Bath Sink Wall Tower	P●53
BDW	.Base Dishwasher Cabinet	L●51
BEADED	.Beaded Inset Door Modification	G●12
BEAS	.Base Easy Access Storage	L●15
BEC	.Base End Cabinet	L●85
BEP	.Angled Base End Panel	Q●15
BEP	.Corner End Panels	Q●23
BEPE..WD	.Base End Panel	Q●14
BEPOF..WD	.End Panels - Full Overlay	Q●15
BEPS	.Skins	Q●18
BEPS..VG	.English Country Car Siding Skins	Q●19
BEPWD	.Base End Panel	Q●14
BER	.Asymmetrical Base Easy Reach	L●69
BER	.Base Easy Reach	L●70
BER..RS	.Base Easy Reach w/Reduced Shelf	L●71
BER..S	.Base Easy Reach w/Lazy Susan	L●73
BER..SKIT	.Lazy Susan Kit	S●8
BFH..CIA	.135° Corner Inside Base	L●88
BFH..COA	.135° Corner Outside Base	L●87
BHRES	.Base Half Round End Shelf	L●101
BIJUNFOOT	.Bijou Bun Foot	R●32
BLOWER	.Wood Hood Blower	K●14

Code	Description	Page Number
BLS	.Base Lazy Susan	L●68
BLSBEPWD	.Lazy Susan Base Panel	Q●20
BLSKIT	.Lazy Susan Kit	S●8
BMC	.Base Message Center	L●109
BMW..RT	.Base Microwave Cabinet w/Roll Tray(s)	N●12
BMW..D	.Base Microwave Cabinet w/Drawer	N●13
BMW..DD	.Base Microwave Cabinet w/Deep Drawer	N●14
BND.ALL	.Band All Edges Modification	G●8
BND.FRT	.Band Location Modification	G●8
BO	.Base Oven Trimmable Cabinet	N●14
BO..AC	.Base Oven Cabinet	N●15
BO..LD	.Base Oven Cabinet w/Lower Drawer	N●16
BOB..AV	.Base Open Basket w/Arched Valance	L●90
BOCB	.Base Open Cabinet w/Car Siding Back	L●107
BOCP	.Base Open Cabinet w/Plain Back	L●107
BODB	.Base Open Cabinet w/Car Siding Back & Drawer	L●108
BODP	.Base Open Cabinet w/Plain Back & Drawer	L●108
BP	.Paneling	Q●19
BP..VG	.English Country Car Siding Paneling	Q●19
BPCS	.Base Pantry Can Storage	L●37
BPP	.Base Pantry Pull-out	L●91
BPPKIT..PG	.Base Can Storage Kit	S●2
BPPP	.Base Pots & Pans Pull-out	L●35
BPS	.Base Pots & Pans Storage	L●35
BPS..KIT	.Base Pots Storage	S●3
BQRES	.Base Quarter Round End Shelf	L●101
BRACKETBAROQUE	.Baroque Bracket	R●24
BRACKETCELTIC	.Celtic Bracket	R●24
BRACKETIND	.Industrial Bracket, Loop	R●24
BRACKETOWD	.Old World Bracket	R●24
BRAIDM	.Braided Moulding	R●6
BRDB	.Base Rotating Deep Bin	L●77
BRDB..KIT	.Lazy Susan Kit	S●8
BRIDGE.BTM	.Position Bridge on Bottom of Wall Cabinet	T●2
BRIDGE.TOP	.Position Bridge on Top of Wall Cabinet	T●2
BRIDGECABLE	.Jumper Cables	T●1
BRKOFFSCREW	.Installation Hardware Parts	S●16
BSC30PR, R, RP, RS, SR	.30" SuperCabinet	L●20
BSC36PRP, PRS, SRP, SRS	.36" SuperCabinet	L●21
BSCG	.Base SuperCabinet Gourmet	L●22
BSD	.Base Spice Drawer	L●100
BSM	.Base Shoe Moulding	R●9
BSP..PG	.Base Spice Pull-out	L●92
BTC	.Base Transition Cabinet	L●84
BTDP	.Base Tray Divider Pantry Pull-out	L●93
BTDPKIT	.Kit Components for BTDP	S●2
BUMPERPADS	.Installation Hardware Parts	S●16
BUMPERRT	.Roll Tray Bumper Pads	S●15
BUMPERSTEM	.Stem Bumper Pads	S●14
BUPP	.Base Utensil Pantry Pull-out	L●92
BUPPKB	.Base Utensil Pantry Pull-out w/Knife Block	L●93
BUPPKBIT	.Kit Components for BUPPKB	S●2
BUPPKIT	.Kit Components for BUPP	S●2
BVR	.Bottom Valance Rail Modification	G●18
BWB	.Base Wastebasket	L●95
BWB..BB	.Base Wastebasket w/Bread Board	L●97
BWB..CHGDRW	.Base Wastebasket w/Charging Drawer	L●99
BWB..FH	.Base Wastebasket Full Height	L●96
BWB..FHKIT	.Wastebasket Assembly	S●11, S●12
BWB..FHRT2	.Base Wastebasket Full Height w/Roll Tray	L●97
BWB..KCUP	.Base Wastebasket w/Wood Tiered K-Cup Drawer	L●98
BWB..KIT	.Wastebasket Assembly	S●11, S●12
BWB..WTC	.Base Wastebasket w/Wood Tiered Cutlery Divider	L●98
BWBFHLID	.Base Wastebasket Lid	S●12
BWBLID	.Base Wastebasket Lid	S●12
BWC	.Base Wine Cubby	L●100
CABCLEANKIT	.Cabinet Care Kit (PURE&SIMPLE™)	S●16
CABMAT	.CabMat	S●13
CABMATV	.CabMat Vanity	S●14
CAPM	.Cap Moulding	R●4
CBEADM	.Center Beaded Moulding	R●6

Code	Description	Page Number	Code	Description	Page Number
CBO	Cabinet Box Only Modification	G•19	DAOVERLAY	Overlay Panels	Q•34
CCG	Craftsman Door Modification	G•14	DBLSQCHARLESTON	Charleston Bead Column, Double Square	R•48
CCO	Cabinet Case Only Modification	G•19	DBLSQSUMTER	Sumter Island Column, Double Square	R•48
CCP	Craftsman Door Modification	G•14	DBLSQTBL	Sumter Table Column, Double Square	R•48
CELTICFOOT	Celtic Foot	R•30	DCM	Corner Tall Moulding	Q•23
CFB	Office & Vanity Fillers	Q•3	DDGK..FXSRTPG	Deep Roll Tray Kit	S•9
CFRTO	Cabinet Front Only Modification	G•20	DDO	Desk Door Drawer Base	O•22
CFP	Cabinet False Panel Modification	G•31	DDR	Desk Drawer Base	O•24
CFRMO	Cabinet Frame Only Modification	G•20	DECOBBM	Deco Baseboard Moulding	R•9
CG	Cut-for-glass Modification	G•14	DF3D	Desk File Drawer Base	O•24
CGRAIL	Door Rail Material	Q•23	DFD	Desk File Drawer Base	L•102
CHARLESESPED	Charleston Pedestal	R•44	DFFSPC	Drawer Front Flat 5-piece Modification	G•10
CHGDRW	Charging Drawer	S•6	DFFSPCINS	Drawer Front Flat 5-piece Inset Modification	G•10
CHGDRW	Charging Drawer Modification	G•38	DFFSPCSLBT	Drawer Front Flat 5-piece w/Slab Top Modification	G•10
CIW	Cutlery Divider	S•5	DFR5PC	Drawer Front Raised 5-piece Modification	G•11
CLBUNNFOOT	Classic Bun Foot	R•29	DFR5PCINS	Drawer Front Raised 5-piece Inset Modification	G•11
CLIP	Clipped Corner Modification	G•20	DFR5PCSLBT	Drawer Front Raised 5-piece w/Slab Top Modification	G•11
CLTCROWN	Classic Tall Crown Moulding	R•2	DFSLB	Drawer Front Slab Modification	G•11
CMAT	CabMat Modification	G•37	DFSLBT	Drawer Front Slab Top Modification	G•12
CND	Cabinet No Door Modification	G•20	DGK..FXSPG	Full Extension Drawer & Roll Tray Slides	S•15
CNTYSB	Country Sink Base Cabinet	L•48	DGK..FXSRTPG	Roll Tray Kit	S•9
CNTYSB..CM	Country Sink Base w/CabMat	L•49	DISLEGL	Fluted Island Leg	R•34
CNVLRAIL	Concave Light Rail Moulding	R•5	DISLEGRP	Rope Island Leg	R•35
CONCAP	Contemporary Cap	R•48	DISLEGSQ	Square Island Leg	R•35
CONVERSION	Ductless Conversion Kit	K•15	DISLEGG	Kitchen Island Leg	R•34
CORBELACAN	Small Acanthus Corbel	R•27	DLEMISSION	Mission Leg	R•35
CORBELACANS	Petite Acanthus Corbel	R•27	DO..FH	Desk Office Base w/Full Height Doors	O•23
CORBELART	Art Corbel	R•26	DOC	Double Outlet Cover	R•50
CORBELART	Arts & Crafts Corbel	R•26	DOORONLY	Door Only	H•1
CORBELARTO	Arts & Crafts Open Corbel	R•26	DRP	Double Rocker Plate	R•50
CORBELBIJL	Large Bijou Corbel	R•27	DRP	Range Panel	L•58
CORBELBIJS	Small Bijou Corbel	R•27	DRRAILCROSS	Door Rail Material	Q•23
CORBELCELTIC	Celtic Corbel	R•26	DRRAILEND	Door Rail Material	Q•23
CORBELCLREV	Classic Revival Corbel	R•26	DRT	Deep Roll Trays Modification	G•31
CORBELCRAFT	Craftsman Corbel	R•25	DRT..SP	Deep Roll Tray Kit	S•9
CORBELCRAFTO	Craftsman Corbel Open	R•24	DRWFERTONLY	Drawer Front Only	H•1
CORBELMIS	Mission Corbel	K•26, R•28	DRWRAILCROSS	Door Rail Material	Q•23
CORBELNOUL	Plain Nouveau Large Corbel	R•27	DRWRAILEND	Door Rail Material	Q•23
CORBELNOUM	Plain Nouveau Medium Corbel	R•28	DRWSEC	Secured Drawer featuring Master Lock Biometric Technology Modification	G•51
CORBELNOUS	Plain Nouveau Small Corbel	R•28	DRWTK	Toekick Drawer Modification	G•30
CORBELOWD	Old World Corbel	K•26, R•28	DSP	Double Switch Plate	R•50
CORBELOWDSTR	Old World Corbel w/Strap	K•26, R•28	DW	Diagonal Wall	J•66
CORBELPALLA	Palladian Corbel	R•25	DW..AG	Diagonal Wall w/Vertical-lift	J•71
CORBELPINN	Pinnacle Corbel	R•27	DW..AGS	Diagonal Wall w/Vertical-lift & Lazy Susan	J•72
CORBELSHKR	Shaker Corbel	R•27	DW..D	Diagonal Wall	J•66
CORBELTRADO	Traditional Open Corbel	R•27	DW..D	Diagonal Wall w/Appliance Garage Open Bottom	J•69
CORBELTRIAD	Triad Corbel	R•26	DW..DS	Diagonal Wall w/Appliance Garage & Lazy Susan Open Bottom	J•70
CORBELWEAVEL	Large Weaved Corbel	R•28	DW..DS	Diagonal Wall w/Lazy Susan	J•70
CORBELWEAVES	Small Weaved Corbel	R•28	DW..FH	Diagonal Wall w/Full Height Door	J•67
COSFOOT	Cosmo Foot	R•30	DW..P	Diagonal Wall Peninsula	J•73
COTCROWN	Cornice Tall Crown Moulding	R•2	DW..S	Diagonal Wall w/Lazy Susan	J•70
COVECROWN	Cove Crown Moulding	R•2	DWLKIT	Lazy Susan Kit	S•8
CPE	Cabinet Panel Edge	R•9	DWPWD	Dishwasher Panel	Q•20
CPU	CPU Base	O•25	EB	Entertainment Base	O•12
CRFTSMNBUNFOOT	Craftsman Bun Foot	R•32	EB..NTK	Entertainment Base, No Toekick	O•12
CRFTSMNFOOT	Craftsman Foot	R•31	EBCF	Entertainment Box Column Filler	O•15
CRFTSMNFOOTC	Craftsman Foot, Corner	R•32	EBDB	Entertainment Base w/Drawers	O•14
CS	Corner Sink Base without Shelf	L•68	EEDB	Entry Ensemble Drawer Base	O•3
CSDG	Car Siding	Q•21	EGRM	Grommet	O•8
CSDGBK	Car Siding Back Modification	G•37	EEHDB	Double Hook Black	O•8
CSFPE	Car Siding Flush Panel End Modification	G•25	EEHDN	Double Hook Nickel	O•8
CUD	Cooking Utensil Divider	S•4	EEHSB	Single Hook Black	O•8
CUDD	Cooking Utensil Divider	S•3	EEHSN	Single Hook Nickel	O•8
DAAUTHENTIC	Authentic Panels	O•28	EEOB	Entry Ensemble Open Base	O•4
DAB	Diagonal Corner Sink Base without Shelf	L•69	EEPWR	Power Strip	O•8
DAB..FS	Diagonal Base w/Full Shelf	L•70	EESTW	Entry Ensemble Stacked Wall	O•6
DAB..KIT	Lazy Susan Kit	S•8	EESTWM	Entry Ensemble Stacked Wall Message	O•7
DAB..S	Diagonal Base w/Full Height Door & Lazy Susan	L•73	EESTWO	Entry Ensemble Stacked Wall Open	O•5
DAB..SLS	Diagonal Base w/Full Height Door & Super Lazy Susan	L•75	EET	Entry Ensemble Tall	O•3
DAINTEGRATEDDF	Integrated Panels	Q•32	ENGNTYLEG	English Country Leg	R•37
DAINTEGRATEDDR	Integrated Panels	Q•32	ENGISLCOLUMN	English Country Island Column	R•44

Code Index

Code	Description	Page Number
ENGISLQTRCOL	English Country Island Quartered Column	R•44
EOD	Entertainment Open Drawer	O•12
EP	Entertainment Platform	O•16
ER	Asymmetrical Easy Reach Wall Corner	J•64-J•65
ER	Easy Reach Wall Corner	J•64
ESTATE	Estate Leg	R•38
ESTW	Entertainment Stacked Wall	O•13
ET	Entertainment Topper	O•16
EW	Entertainment Wall	O•13
EX	Extended Stiles Modification	G•21
EXBK	End Extended Back Modification	G•25
EXBOL	Extended Stile w/Overlay Modification	G•20
EXDN	Wall End and Back Extended Down Modification	G•28
EXLOL	Extended Stile w/Overlay Modification	G•20
EXROL	Extended Stile w/Overlay Modification	G•20
EXT.BTM.LGT.C	Add Exterior Cool Light to Bottom of Wall Cabinet	T•3
EXT.BTM.LGT.W	Add Exterior Warm Light to Bottom of Wall Cabinet	T•3
F	Wall Fillers	Q•2
F.ALL	Finished Edges - All Modification	G•8
F.FRT	Finished Edges Modification	G•8
FALSEPANELCLIP	Turnbuckles for False Drawer Fronts	S•15
FB	Angled Fillers	Q•13
FB	Base Fillers	Q•2
FB	Wall & Base Fillers	Q•3
FBCO	Office & Vanity Fillers	Q•3
FBCV	Office & Vanity Fillers	Q•3
FBF	Finished Blind Modification	G•21
FD	Full Depth Shelf Modification	G•39
FD	Furniture Drawer	L•103, L•104
FDSRTBTM	Roll Tray Bottom w/Full Depth Shelf Modification	G•31
FDWB	Furniture Drawer Window Bench	L•105
FF	Wall Fluted Fillers	Q•4
FFB	Base Fluted Fillers	Q•4
FFD	Face Frame and Door on End Modification	G•26
FFO	Office Fluted Fillers	Q•5
FFRAIL	Frame Rail Material	Q•23
FFV	Vanity Fluted Fillers	Q•5
FILTER	Ductless Conversion Kit	K•15
FINKIT	Finish Kit	E•12
FL	Finished Ends Modification	G•8
FLUT	Fluting Modification	G•38
FLUT	Fluting on Fillers Modification	G•38
FLUTELEG	Flute Leg	R•41
FO	Angled Fillers	Q•13
FO	Office Fillers	Q•2
FOLCROWN	Full Overlay Crown Moulding	R•3
FOOTMETAL	Bath Feet	P•67
FOOTULIPSQ	Tulip Foot Square	R•29
FPE	Flush Panel End Modification	G•26
FR	Finished Ends Modification	G•8
FRNCNTYFOOT	French Country Foot	R•31
FRNCNTYLEG	French Country Leg	R•38, R•39
FRNCNTYRDLEG	French Country Reeded Leg	R•39
FRNCNTYSQLEG	French Country Square Leg	R•39
FRNLG	Queen Anne Leg	R•40
FS	Floating Shelf	J•91, R•22
FSCO.KIT	Food Storage Container Organizer Kit	S•2
FTF	Tall Fluted Fillers	Q•5
FTK	Flush Toekick Modification	G•21
FTKAV	Flush Toekick - Arch Modification	G•21
FU	Angled Fillers	Q•13
FV	Angled Fillers	Q•13
FV	Vanity Fillers	Q•2
FW	Angled Fillers	Q•13
FW	Wall & Base Fillers	Q•3
GAELICLEG	Gaelic Leg	R•41
GAMD	Gallery Mullion Door Modification	G•14
GLAZEPEN	Glaze Pen	E•12
GLAZEQUART	Quart of Glaze	E•12
GPOKIT	Bath Grooming Pull-out Kit	P•67
GRO	Grape Rosette	R•16

Code	Description	Page Number
GROVLY	Grape Decorative Onlays/Overlays	R•21
GSK	Bath Glass Shelf	S•7
GSK	Glass Shelf Kits	S•7
H.DF	Hearth Door Front Configurations	K•24, K•25
HAMPERKIT	Bath Hamper Kit	P•66
HAMPERKIT	Chrome Hamper	S•12
HAMPPEDFOOTC	Hampton Pedestal Foot, Corner	R•31
HAMPPEDFOOTCTR	Hampton Pedestal Foot, Center	R•31
HAMPPEDFOOTL	Hampton Pedestal Foot, Left	R•31
HAMPPEDFOOTR	Hampton Pedestal Foot, Right	R•31
HB	Hutch Base	L•106
HCG	Horizon Door Modification	G•15
HCP	Horizon Door Modification	G•15
HE	Hutch End Panel	Q•20
HIF	Inset Finial Hinges	S•16
HINGE	Hinges	S•15
HINGEISCLPT	Hinge Plates	S•16
HINGERESCLIP	Hinge Angle Restriction Clip	S•15
HINGERESCLIPIN	Hinge Angle Restriction Clip Inset	S•15
HL	Hearth Liner	K•26
HM	Hearth Mantel	K•23
HNGSPACER	Hinge Spacers	S•14
HOF	Hearth Overlay Fillers	K•26
HP	Hearth Pier	K•22
HPP	Hearth Pier Pull-out	K•23
HPPKIT	Hearth Tower Pull-out Kit	S•8
HS	Hearth Shelf	K•25
IAPPLIANCE	Inset Appliance Panels	Q•30
ICM	Inside Corner Moulding	R•8
ICMA	Inside Corner Moulding (#2)	R•8
ID	Increased Depths Modification	G•39
IF	Inset Finial Hinges Modification	G•12
IH	Increased Heights Modification	G•40
INDFOOT	Industrial Foot	R•33
INSCROWN	Inset Panel Crown	R•4
INSERTFRM	Create-A-Crown Inset	R•4
INT.ALL.LGT	Add Interior Light to All Openings of Cabinet	T•2
INT.BTM.LGT	Add Interior Light to Bottom Opening of Cabinet	T•3
INT.LGT	Add Interior Light to Single Opening Wall Cabinet or Corner Base Cabinet	T•2
INT.MID.BTM.LGT	Add Interior Light to Middle and Bottom Openings of Cabinet	T•3
INT.MID.LGT	Add Interior Light to Middle Opening of Cabinet	T•2
INT.TOP.BTM.LGT	Add Interior Light to Top and Bottom Openings of Cabinet	T•3
INT.TOP.LGT	Add Interior Light to Top Opening of Cabinet	T•2
INT.TOP.MID.LGT	Add Interior Light to Top and Middle Openings of Cabinet	T•3
INTGE	Integral End Modification	G•28
INVFRM	Inverted Frame Modification	G•21
IPE	Inset Panel Ends Modification	G•27
IW	Increased Widths Modification	G•46, G•48
JINSERTLRC	Contemporary Light Rail Moulding	R•5
JINSERTLRT	Traditional Light Rail Moulding	R•5
JWHL	Wood Hood Linear	K•12
JWHSHPCH	Wood Hood Shiplap Tapered Chimney	K•10
JWHSHPSTR	Wood Hood Shiplap Straight	K•9
JWHSHPSTRCB	Wood Hood Shiplap Straight w/Corbels	K•9
JWHSHIPT	Wood Hood Shiplap Tapered	K•10
JWHSHIPTCB	Wood Hood Shiplap Tapered w/Corbels	K•10
KBT	Keyboard Tray	O•25
KCUP	Wood Tiered K-Cup Drawer w/Installation Hardware	S•6
KENSFOOT	Kensington Foot	R•31
KENSINGLEG	Kensington Leg	R•39
KF	Stainless Hood Filter	K•13
KNOB	Decorative Pulls & Knobs	S•17-S•18
LB	Light Baffle	R•5
LC	Linen Closet	P•50
LCRH	Linen Closet w/Removable Hamper	P•51
LEXISLKIT	Lexington Island Pedestal Kit	R•43
LEXSHLFSTRP	Lexington Shelf Strap	R•24
LEXTBLKIT	Lexington Table Pedestal Kit	R•43
LGCORBEL	Large Shelf Support	R•23
LGGRPSUPPORT	Large Grape Shelf Support	R•23
LH.KIT	Lid Pull-out Kit	S•13

Code	Description	Page Number	Code	Description	Page Number
LIFLUTFOOT	Lille Fluted Foot	R•29	OL	Utility Overlay Fillers	Q•9
LIFOOT	Lille Foot	R•29	OL	Wall Overlay Fillers	Q•8
LO	Lid Organizer	S•8	OMC	Microwave & Single Oven Trimmable Cabinet	N•27-N•28
LOSC	Large Outside Corner	R•9	OMC.AC	Built-in Oven Microwave Cabinet	N•22-N•26
LRCROWN	Large Insert Crown	R•3	OMC.DD	Microwave & Single Oven Trimmable Cabinet w/Deep Drawer	N•29-N•30
LRM	Light Rail Moulding	R•5	OSV	Overlay Valance	R•21
LSACROWN	Large Straight Angle Crown Moulding	R•3	PAINTQUART	Quart of Paint	E•12
LSHAKER	Large Shaker Crown Moulding	R•3	PDM	Premium Door Mechanism	S•16
LSM	Large Scribe Moulding	R•7	PDO	Pegged Dish Organizer	S•8
LSP	Lazy Susan Pull-out	L•78	PDOPOSTS	Pegged Dish Organizer	S•8
LSPOLEKIT	Lazy Susan Pole Kit	S•8	PEDFOOTC	Pedestal Foot - Corner	R•29
LT	Linen Storage Cabinet	P•51	PEDFOOTL	Pedestal Foot - No Return Left	R•29
MADEFOOT	Madeline Bun Foot	R•31	PEDFOOTR	Pedestal Foot - No Return Right	R•30
MADLINEPOSTL	Madeline Post, Large	R•37	PEDFOOTREL	Pedestal Foot - Return Left	R•30
MADFOOT	Madison Foot	R•31	PEDFOOTRETR	Pedestal Foot - Return Right	R•30
MAGCATCHINSET	Inset Magnetic Catches	S•15	PFINBTMB	Finished Bottom Modification	G•8
MCFOOTM	Mid-Century Foot, Medium	R•33	PIL	Pilasters	Q•24, Q•25
MCFOOTS	Mid-Century Foot, Short	R•32	PPH.KIT	Pots & Pans Pull-out Kit	S•9, S•13
MCFOOTT	Mid-Century Foot, Tall	R•33	PPP.KIT	Pots & Pans Pull-out Kit	S•9, S•13
MCG	Mission Door Modification	G•15	PRCCOLUMN	Pacific Rim Create A Column	R•47
MCISLCOLUMN	Mid-Century Island Column	R•47	PRISLCOLUMN	Pacific Rim Island Column	R•47
MCLEG	Mid-Century Table Leg	R•42	PRLEG	Pacific Rim Leg	R•42
MCMFOOT	Mid-Century Metal Foot	R•33	PRMD	Prairie Mullion Doors Modification	G•16
MCP	Mission Door Modification	G•15	PRO	Profiled and Finished Edges Modification	G•9
MCVANCOLUMN	Mid-Century Vanity Column	R•47	PRO.ALL	Profiled and Finished Edges - All Modification	G•9
MD	Mullion Doors Modification	G•16	PSBKIT	Plastic Storage Bins	S•8
MDCCRNSHLF	Modern Corner Shelf	R•22	PTOWB	Push-to-Open Wastebasket Modification	G•13
MDCLIPS	Mullion Door Clips	S•14	PULL	Decorative Pulls & Knobs	S•17-S•18
MDENTIL8	Dentil Moulding	R•6	PWRPOD	Power Pod	S•11
MDFLCRNSHLF	Modern Floating Corner Shelf	R•22	PY	Pantry Unit	M•29-M•30
METBARCOLUMN	Metro Bar Column	R•45	QACRNACALEG	Queen Anne Corner Acanthus Leg	R•40
METISLCOLUMN	Metro Island Column	R•45	QACRNFLUTLEG	Queen Anne Corner Fluted Leg	R•40
METROFOOT	Metropolitan Foot	R•32	QACRNLEG	Queen Anne Corner Leg	R•40
MFO	Modified Full Overlay Modification	G•13	QAFOOT	Queen Anne Foot	R•32
MIP	Matching Interior Modification	G•9	QALEGT	Queen Anne Buffet Column	R•46
MIXKIT	Mixer Shelf w/Pop-Up Shelf	S•8	QASCROLLFOOT	Queen Anne Scroll Foot	R•32
MLDG	Moulding Location Modification	G•36	QRM	Quarter Round Moulding	R•8
MSACROWN	Medium Straight Angle Crown Moulding	R•3	R.PD	Range Platform w/Drawers	L•58
MITCROWN	Tall Crown Moulding	R•4	RCPV	Recessed Panel Valance	R•18
MUNTIN	Door Rail Material	Q•23	RCTM	Round Countertop Moulding	R•7
MV	Vanity Base without Shelf	P•13	RD	Reduced Depths Modification	G•39
MW	Wall Microwave Cabinet	N•3	RDBUNNFOOT	Bunn Foot	R•29
MW	Wall Microwave Double Door Cabinet	N•4-N•8	RDLEG	Read Leg	R•34
NAT	Natural Material	Q•20	REC	Recessed Vanity Wall Modification	G•22
NATVEN	Natural Veneer	Q•21	RECTK	Recessed Toekick Modification	G•29
NHC	No Hinge Cut Modification	G•16	RECTK_6	Recessed Toekick - 6" Modification	G•29
NMCFOTM	Notched Mid-Century Foot, Medium	R•33	RECTKFRT	Recessed Toekick Front Modification	G•30
NMCFOT	Notched Mid-Century Foot, Tall	R•33	RECTKFRT6	Recessed Toekick Front - 6" Modification	G•30
NMCISLCOLUMN	Notched Mid-Century Island Column	R•47	RETAINER	Retainer Clips	S•14
NMCVANCOLUMN	Notched Mid-Century Vanity Column	R•47	RH	Reduced Heights Modification	G•40
NOBEAD	Inset Door Modification	G•12	RHSS	Range Hood Stainless Steel Square	K•13
NOULEG	Plain Nouveau Island Column	R•45	RHST	Range Hood Stainless Steel Tapered	K•13
NOULEGT	Plain Nouveau Bar Column	R•45	ROPELEG	Rope Leg	R•40
O.BCFP	Box Column Fillers, Office	Q•11	ROSETTEACA	Acanthus Rosette	R•16
OBRB	Open Bottom Rail Base Modification	G•22	ROSETTEFLW	Flower Rosette	R•16
OC	Outside 135° Corner Moulding	R•8	ROSETTEGAE	Small Gaelic Rosette	R•16
OCD	Double Oven Trimmable Cabinet	N•35-N•36	ROSETTELGPK	Peaked Large Rosette	R•16
OCD.AC	Built-in Double Oven Cabinet	N•47-N•50	ROSETTEMIS	Mission Rosette	R•16
OCD.DD	Double Oven Trimmable Cabinet w/Deep Drawer	N•51-N•52	ROSETTEPINN	Pinnacle Rosette	R•21
OCM	Outside Corner Moulding	R•8	ROSETTESMPK	Peaked Small Rosette	R•16
OCM.AC	Tall Built-in Microwave Cabinet	N•17-N•19	ROSETTETRIAD	Triad Rosette	R•21
OCS	Single Oven Trimmable Cabinet	N•43-N•44	ROSFLOT	Rose Fluting Modification	G•50
OCS.AC	Built-in Single Oven Cabinet	N•39-N•42	ROSFLOT	Rose Fluting on Fillers Modification	G•50
OCS.DD	Single Oven Trimmable Cabinet w/Deep Drawer	N•45-N•46	ROUNDBASE	Round Base	R•44
OCSD	Single Oven Trimmable Cabinet w/Drawers	N•37-N•38	RPM	Rope Moulding	R•6
OCSD.AC	Built-in Single Oven Cabinet w/Drawers	N•31-N•34	RPV	Raised Panel Valance	R•18
OFB	Base Overlay Fillers	Q•9	RSTCCRNNSHLF	Rustic Corner Shelf	R•21
OFBC	Overlay Fillers	Q•10	RSTCFITCRNSHLF	Rustic Floating Corner Shelf	R•22
OFO	Office & Vanity Overlay Fillers	Q•9	RT	Roll Trays Modification	G•32
OFV	Office & Vanity Overlay Fillers	Q•9	RT.SP	Roll Tray Kit	S•9
OGEEM	Ogee Moulding	R•6	RW	Reduced Widths Modification	G•49

Code Index

Code	Description	Page Number
SACROWN	Straight Angle Crown Moulding	R•3
SB	Sink Base	L•38, L•43
SB..CDY	Sink Base Double Door w/Caddy	L•39
SB..CM	Sink Base Double Door w/CabMat	L•39
SB..D	Sink Base w/Drawer Below	L•50
SB..S	Sink Base SuperCabinet	L•45
SB..SCDY	Sink Base SuperCabinet w/Caddy	L•45
SB..SCM	Sink Base SuperCabinet w/CabMat	L•46
SB..ST	Sink Base w/Tilt-out Tray	L•40-L•41, L•44
SB..STCDY	Sink Base w/Tilt-out Tray & Caddy	L•42
SB..STCM	Sink Base w/Tilt-out Trays & CabMat	L•42
SB..STS	Sink Base SuperCabinet w/Tilt-out Tray	L•46
SB..STSCDY	Sink Base SuperCabinet w/Tilt-out Tray & Caddy	L•47
SB..STSCM	Sink Base SuperCabinet w/Tilt-out Trays & CabMat	L•47
SBARLEG	Bar Leg	R•35
SBCADDY	Sink Base Cleaning Caddy	S•14
SBCADDY	Sink Base Cleaning Caddy Modification	G•51
SBCADDYSM	Sink Base Cleaning Caddy	S•14
SBCADDYSM	Sink Base Cleaning Caddy Small Modification	G•51
SBE	Single Bead Edge	R•6
SBM	Single Bead Moulding	R•6
SBS	Countertop Support	R•23
SCM	Soffit Scribe Crown Moulding	R•4
SCPDWR	Scooped Drawers Modification	G•32
SD	Spice Drawer	S•10
SF	Sink Front	L•51, L•52
SFB	Sink Front Bottom	L•52
SFM	Soffit Filler Moulding	R•2
SGLPN	Single Panel Tall Door Modification	G•13
SHAPE	Profile Edge Moulding	R•7
SHELF	Shelving Material	Q•22
SHELFIND	Floating Shelf	R•22
SHELFIND	Industrial Shelf	R•22
SHELFPGGS	Plastic Shelf Clips	S•14
SHKRCRM	Shaker Crown Moulding	R•3
SHM	Shoe Convex Inside Corner Moulding	R•8
SHMD	Shaker Mullion Door Modification	G•16
SIMCROWN	Simplicity Crown	R•2
SISLLEG	Island Leg	R•36
SLS..KIT	Lazy Susan Kit	S•8
SLSR	Super Lazy Susan w/Chrome Rail	L•76
SLSR..CD	Super Lazy Susan w/Chrome Rail & Corner Drawer	L•77
SLSR..KIT	Lazy Susan Kit	S•8
SLSR..RS	Super Lazy Susan w/Chrome Rail & Reduced Shelf	L•72
SLSW	Super Lazy Susan	L•74
SM	Small Batten Moulding	R•8
SM..LG	Large Batten Moulding	R•8
SMCORBEL	Small Shelf Support	R•23
SMCOVECROWN	Small Cove Crown Moulding	R•2
SMGRPSUPPORT	Small Grape Shelf Support	R•23
SMLR	Small Light Rail Moulding	R•5
SMSQFOOT	Square Foot	O•15, R•29
SOC	Single Outlet Cover	R•50
SOLID	Solid Wood	Q•22
SPICE..PG	Spice Pull-out	S•10
SPLG	Spool Leg	R•34
SPLITDR	Split Doors Modification	G•13
SPLITDRWS	Split Drawers Modification	G•13
SPTRINGEND	Split Turning Systems End	R•17
SPTRINGREED	Split Turning Systems Reed	R•17
SPTRINGROPE	Split Turning Systems Rope	R•17
SPTRINGSPPOOL	Split Turning Systems Spool	R•18
SQBARLEG	Bar Leg, Square	R•35
SQSLLG	Island Leg, Square	R•36
SQLEG	Square Leg w/Sleeve	R•42, R•43
SRP	Single Racker Plate	R•50
SRT	Scooped Roll Tray Modification	G•32
SRT..SP	Scooped Roll Tray Kit	S•10
SSC	Lacquer Spray Can	E•12
SSM	Small Scribe Moulding	R•7
SSP	Single Switch Plate	R•50

Code	Description	Page Number
STAINQUART	Quart of Stain	E•12
STAND	Standard Drivers	T•1
STBRACKETIND	Industrial Bracket, Straight	R•24
STKMLD	Stack Moulding Kits	R•10-R•15
STM	Soffit Trim Moulding	R•5
STORB	Storage Open Rail Base Modification	G•22
STR	Sliding Towel Bar	S•10
STR	Starter Moulding	R•2
STRETCHERMAT	Stretcher Material	Q•22
STRS	Starter Shaker Moulding	R•2
STW	Stacked Wall	J•28-J•35
STW	Stacked Wall Cabinet Heights Modification	G•22
STWAG	Stacked Wall w/VerticalHift	J•36-J•39
STWDAG	Stacked Wall w/Appliance Garage	J•24-J•27
STWEC	Stacked Wall End Cabinet Single Door	J•42
STWEC..D	Stacked Wall End Cabinet Double Door	J•41
STWTC	Stacked Wall Transition Cabinet	J•43, J•44
SUMFOOT	Summit Foot	R•30
SWCRM	Crown Moulding	R•2
SWLCRM	Large Crown Moulding	R•3
SWTCRM	Solid Wood Tall Crown Moulding	R•4
SWVCRM	Insert Crown Moulding	R•3
T..BCAV	Tall Bookcase w/Arched Valance	O•29-O•31
T..BCFP	Box Column Fillers, Tall	Q•12
T4SLEG	Tapered 4-Sided Leg	R•30
TABLETHLDR	Tablet Holder	S•11
TAPLG	Tapered Leg	R•30
TB8WD	Toe Board Trim	Q•19
TBATM	Traditional Batten Moulding	R•8
TBEM	Triple Bead Moulding	R•6
TBMWB	Oven Microwave Trimmable Cabinet	N•20-N•21
TBN	Nickel Towel Bar Modification	G•24
TCEP	Corner End Panels	Q•23
TCG	Transom Doors Modification	G•17
TCM	Beveled Edge Moulding	R•7
TCP	Transom Doors Modification	G•17
TCROWN	Tall Crown Moulding	R•4
TD	Base w/Tray Divider	L•83
TD	Tray Divider Modification	G•52
TD..BCAV	Tall Bookcase w/Doors & Arched Valance	O•32-O•34
TD..FH	Full Height Base w/Tray Divider	L•83
TDKIT	Tray Divider	S•10
TD0..BCAV	Tall Bookcase w/Office Height Doors & Arched Valance	O•38-O•40
TDRO	Tray Divider Roll-out	S•10
TDROHDWONLY	Tray Divider Roll-out	S•10
TDV..BCAV	Tall Bookcase w/Vanity Height Doors & Arched Valance	O•35-O•37
TEP	Angled Tall End Panels	Q•15
TEP	Refrigerator Panel	Q•16-Q•18
TEP..OF3WD	End Panels - Full Overlay	Q•15
TEPS	Skins	Q•18
TEPS..VG	English Country Car Siding Skins	Q•19
TF	Tall Fluted Fillers	Q•5
TF	Utility Fillers	Q•3
TKC	Toekick Caps	Q•19
TKP	Toekick Pedestal Modification	G•30
TKTLFOOT	Toekick Tulip Foot	R•29
TLCROWN	Tall Crown Moulding	R•4
TLEG	Tapered Leg	R•30
TLFOOT	Tulip Foot	R•29
TLR	Traditional Light Rail	R•5
TM	Trim Moulding	R•4
TONERQUART	Quart of Toner	E•12
TOTSSS	Tilt-out Tray(s) Stainless Steel	S•6
TPP	Tall Pantry Pull-out	M•26-M•28
TRIBRKT	Mid-Century Bracket	R•23
TROSETTE	Traditional Rosette	R•16
TSTM	Traditional Soffit Trim Moulding	R•4
TUK	Touch-up Kit	E•12
TVR	Top Valance Rail Modification	G•23
TWH	Tapered Wood Hood	K•12
TWHBLOWER	Wood Hood Blower	K•14

Code	Description	Page Number	Code	Description	Page Number
U	Utility	M•3-M•15	WBMW	Wall Built-in Microwave Double Door Cabinet	N•5-N•10
U.RT	Utility w/Roll Trays	M•21-M•25	WBMW.AC	Wall Built-in Microwave Double Door Cabinet	N•5-N•10
U3D	Utility w/Three Drawers	M•16, M•17	WC	Wall Corner Double Door	J•55-J•63
U4D	Utility w/Four Drawers	M•18, M•19	WC	Wall Corner Single Door	J•52-J•62
UCD	Under Counter Drawer	P•46	WCD	Wall China Display	J•95
UCD..T	Under Counter Drawer, Trimmable	P•46	WCT	Traditional Window Casing	R•9
UDBX	U-shaped Drawer Box Modification	G•33	WCT	Water Closet	P•6
UDRT.SP	U-shaped Deep Roll Tray Kit	S•7	WCV	Wine Cube Vertical	J•96
UI	Utility Inverted	M•20-M•21	WEAS	Wall Easy Access Storage Cabinet	J•13
UOC	Utility Organizer Cabinet	M•31-M•38	WEAVEBUNFOOT	Weaved Bun Foot	R•32
UOCDZ	Utility Organizer Drop Zone Cabinet	M•39-M•40	WEAVELEG	Weaved Island Column	R•46
UOCDZ..AE	Utility Organizer Drop Zone Cabinet w/Authentic End	M•41	WEAVELEGL	Large Diamond Weaved Island Column	R•46
URBISLCOLUMN	Urban Island Column	R•46	WEC	Wall End Cabinet Single Door	J•87
URT	U-shaped Roll Tray Modification	G•34	WEC.D	Wall End Cabinet Double Door	J•86
URT.SP	U-shaped Roll Tray Kit	S•7	WEP	Angled Wall End Panel	Q•14
UV	Vanity Utility	P•47-P•49	WEP	Corner End Panels	Q•23
V	Valances	R•19-R•20	WEPF	Wall End Panel	Q•13
V	Vanity Base Single Door without Shelf	P•11	WEPOF.WD	End Panels - Full Overlay	Q•15
V	Vanity Base without Shelf	P•12	WEPS	Skins	Q•18
V..BCFP	Box Column Fillers, Vanity	Q•11	WEPS..VG	English Country Car Siding Skins	Q•19
V..S	Vanity Base Single Door w/Shelf	P•9	WFOOTCHARLESTON	Charleston Bead Column w/Foot	R•47
V..S	Vanity Base w/Shelf	P•10	WGH	Stem Glass Holder	S•10
VACSF	Vanity Angled Corner Sink Front	P•45	WHA	Classic Wood Hood Arch	K•3
VB	Vanity Base, Double Door w/Drawer	P•8	WHAFP	Wood Hood Arch Flat Panel	K•3
VB	Vanity Base, Single Door w/Drawer	P•7	WHAS	Wood Hood Artisan Straight	K•12
VBP	Vanity Base Pull-out	P•13	WHC	Classic Wood Hood Chimney	K•4
VBPKIT	Vanity Base Pull-out Kit	S•11	WHCA	Wood Hood Canopy Arched	K•5
VCB.D	Vanity Combination Drawer Base w/Three Drawers	P•28	WHCS	Wood Hood Canopy Square	K•6
VCS.D.FP	Vanity Sink Drawer Base w/Three Drawers & False Panel	P•23-P•24	WHNA	Wood Hood Nantucket Arch	K•8
VDB	Vanity Three Drawer Base	P•42-P•43	WHNC	Wood Hood Nantucket Chimney	K•8
VDL2130WD	Tapered Vanity End Panel	Q•20	WHNS	Wood Hood Nantucket Straight	K•8
VEN	Veneer	Q•21	WHS	Classic Wood Hood Square	K•4
VEPS	Skins	Q•18	WHSBATTEN	Wood Hood Straight Batten - Profiled	K•7
VEPS.VG	English Country Car Siding Skins	Q•19	WHSFP	Wood Hood Square Flat Panel	K•4
VFR	Valley Forge Moulding	R•5	WHSMC	Wood Hood Simple Chimney	K•11
VH.FH	Vanity Hamper Base Cabinet	P•38	WHSMT	Wood Hood Simple Tapered	K•11
VLSO	L-shaped Organizer	G•50	WHSMTCB	Wood Hood Simple Tapered w/Corbels	K•11
VM	Vanity Mirror	P•5	WMC	Wall Message Center	J•90
VMP	Bath Mirror Wall Pull-out	P•66	WNR	Wall Wine Rack	J•93
VS3D	Vanity Sink Base w/Three Drawers	P•25	WNRMAT	Criss Cross Wine Rack Material	Q•20
VS8	Vanity Sink Base w/False Panel	P•14-P•17	WOB8	Wall Organizer & Bookshelf	J•92
VS8..U	Vanity Sink Base w/U-shaped Roll Trays	P•17	WOCB	Wall Open Cabinet w/Car Siding Back	J•51
VS8D	Double Vanity Sink Base	P•37	WOCF	Wall Open Cabinet w/Plain Back	J•50
VS8S	Victorian Countertop Support	R•23	WOODTOP	Wood Tops	Q•6
VSD.FP	Vanity Sink Drawer Base w/False Panel	P•21-P•22	WORG	Wall Organizer	J•91
VSF	Vanity Sink Front	P•41	WP	Paneling	Q•19
VSHDB.D	Vanity Sink & Hamper Drawer Base	P•39	WQRES	Wall Quarter Round End Shelf	J•98-J•101
VSSB..ST	Vanity Sink Base SuperCabinet w/Tilt-out Trays	P•18	WS	Wide Stiles Modification	G•24
VTK	Void Toe Kick Modification	G•30	WSC	Wall Wine Storage Cabinet	J•94
VUD	Vanity Utility w/Drawers	P•50	WSCRIBE	Wide Scribe Moulding	R•7
VU	Straight Valance	R•19	WSD	Wall Spice Drawer Horizontal	J•97
VWB	Vanity Wastebasket Container	G•52	WSDV	Wall Spice Drawer Vertical	J•97
VWR	Vanity Recessed Cabinet	P•4	WSP	Wall Spice Pull-out Cabinet	J•101
VWR	Vanity Wall Recessed Cabinet	P•5	WSPKIT	Wall Spice Pull-out Kit	S•11
W	Vanity Wall	P•3, P•4	WSRC	Wall Spice Rack Cabinet	J•102
W	Wall	J•3-J•19	WTC	Wall Transition Cabinet	J•40
W	Wall Refrigerator	J•45-J•48	WTC.D	Wood Tiered Cutlery Divider Drawer Modification	G•52
W	Wine Cube Horizontal	J•96	WTC.D	Wood Tiered Cutlery Divider Drawer w/Installation Hardware	S•5
W..BCAV	Wall Bookcase w/Arched Valance	Q•26-Q•28	WTCLIP	Clipped Corner Wood Tops Modification	G•35
W..BCFP	Box Column Fillers, Wall	Q•10	WTH..BF	Wall Top Hinge w/Bifold	J•15
W..CIA	135° Corner Inside Wall	J•89	WTH..CLIP	Hinge Restriction Clip	S•16
W..COA	135° Corner Outside Wall	J•88	WTH..SL	Wall Top Hinge w/Stay Lift	J•9
W..P	Wall Peninsula	J•74-J•77	WTKCUP	Wood Tiered K-Cup Drawer Modification	G•52
W..PO	Wall Refrigerator Pull-out Cabinet	J•49	WTOPBAC..BE	Wood Tops for Angled & Base End Cabinets - Beveled Edge	Q•7
W2D	Wall w/Two Drawers	J•20-J•21	WTOPBAC..OG	Wood Tops for Angled & Base End Cabinets - Ogee Edge	Q•7
W3D	Wall w/Three Drawers	J•22-J•23	WTOPBAC..RO	Wood Tops for Angled & Base End Cabinets - Round Over	Q•8
WAIN	Wainscoting	Q•27	WTOPBAC..SE	Wood Tops for Angled & Base End Cabinets - Square Edge	Q•8
WASTE8IN	Wastebasket Only	S•12	WTR	Wide Top Rail Modification	G•24
WB	Wall Base	L•23	WTVD	Wood Tiered Vanity Drawer Kit	S•6
WBCPO	Wall Box Column Pull-out, Plain	J•103	WVL	Wall Top Hinge w/Vertical-Lift & Stay Lift	J•5-J•6
WBCPO..OL	Wall Box Column Pull-out, Overlay	J•104	WWR	Wall Cabinet w/Wine Rack	J•92
WBCPOK8UP	Wall Box Column Pull-out w/K-Cup	J•105	XEND	X-End Panel	R•50

CONSTRUCTION OPTIONS

Consider exposed end options:

- Adding a veneer finished end (FL or FR) will age uniformly with the rest of the kitchen.
- Apply Flush End (FPEL/FPER). This will allow the ends to age uniformly with the rest of the kitchen and will make it flush.
- Upgrade exposed cabinet ends with Authentic Ends (AUTHL/AUTHR/AUTHB) Modification.

WOOD AND FINISH CHARACTERISTICS

Review specific details with the customer:

- Mineral Streaks, Birdseye Dots, Grain Variations (especially Rustic Alder).
- Color Variations/Darkening (especially Natural/Light Cherry).
- Finish Variations (Glazes are "consistently inconsistent"), hairline cracks may develop at frame joints on painted frame.
- Underside of cabinets are Natural Maple. Use light rail or PFINBTMB to hide, especially when designing with peninsula wall cabinets. For cabinets that are bridged between taller adjacent cabinets, specify PFINBTMB modification. See page G•8 for more details.

LOGIX®

Review storage and usage needs with Customer. See chart on pages I•1-I•2 for more Logix®.

- Storage Solutions:
 - SuperCabinet™
 - Base Rotating Deep Bin
 - Pegged Dish Organizer
 - Wall Message Center
- Clean-up Center:
 - Base Wastebasket

CLEARANCES

- Add fillers or extended stiles between end cabinets and walls on full overlay door styles.
- Allow space between door/window trim and end cabinets for countertop and top moulding overhang.
- Include refrigerator door hinges in overall refrigerator height when placing cabinets above it.

Maintain a minimum clearance of 3" by pulling blind corners as follows:

- Full Overlay: 1 1/4", Standard Overlay 1/2". (More is needed in certain situations such as when adjacent to an appliance or when using oversized pulls or knobs.)
- Allow sufficient clearance (3") on each side of accessory cabinets (such as roll-out trays, swing-out units, etc.). Doors on these cabinets must open fully for accessories to be functional.
- Ensure the height between the cooktop and range hood is 24" to meet NKBA guidelines.

Qualify customer carefully on upper cabinet/microwave advantages/disadvantages as follows:

- Minimum of 18" from cooktop to upper cabinet/above the range microwave which allows for easy access to either, but less room over back burner.
- Minimum of 21" from cooktop to upper cabinet/microwave which allows for access to large pots on back burner of cooktop, but longer reach to microwave.

FILLERS

- Place fillers toward end of run where least conspicuous if needed.
- Attach overlay fillers on top of the base, wall, or tall fillers when using full overlay door styles to maintain a consistent reveal. Don't forget to include blind corner fillers.
- Add a filler at least 6" wide to accommodate a decorative onlay when the filler is used as valance.

VARYING HEIGHTS AND DEPTHS

- Also increase the depth of a wall cabinet run when you increase the height (so moulding on adjacent cabinet will kill into the side of the taller cabinet).
- Skin the sides of tall cabinets to keep adjacent base and wall cabinets out from reveal of tall cabinet.
- Add increased depth on tall end panels for a built-in look for deep refrigerators.
- Account for the additional support needed for wall cabinets with a depth of 18" or greater. This can be achieved by installing a soffit or end panels.

MATCHING INTERIOR CABINETS/GLASS OPTIONS

- Verify cut-for-glass or mullion door option is available on desired cabinet size. (See pages H•4-H•12 for available cut-for-glass/mullion door sizes.)
- Verify glass insert option is available for desired cut-for-glass door size chosen.
- Verify matching interior option has been selected for all open or glass cabinets.
- Use light rail and PFINBTMB to hide color variation between bottom of cabinets with and without matching interior.
- Verify mullion door lite grid matches customer expectations.

MOULDINGS

- Order rosettes and plinths in beaded or fluted styles to match fillers.
- Verify correct amount of crown moulding has been ordered.
- Order toekick caps.
- Order extra scribe.

ISLANDS AND PENINSULAS

- Consider standard height bars are 34 1/2" tall and require 19" knee space. Raised bars are 42" tall.
- Consider base peninsula cabinets (B_P) are 24 1/4" deep and require 12" of knee space. Use back panels/doors to flush non B_P cabinets with B_P cabinets.
- Use recess toe on sides and back or BBM8 when using multiple base cabinets to create an island.
- Use outside corner moulding if a skin is exposed on the back of the island.

APPLIANCES

- Note for all consumers, appliances are not included with any cabinetry product.
- Do not place dishwashers next to diagonal front cabinet (interference) or next to a range (no countertop support).
- Verify refrigerator door has enough clearance to open beyond 90° so refrigerator drawers can be utilized. Refer to appliance manufacturer's specs.
- Order appliance panels.

SPECIAL CONSIDERATIONS

- Consider V-groove skins and/or decorative doors on exposed cabinet sides in glazed kitchen.

MISCELLANEOUS

- Order full size touch-up kit (mini touch-up kit included with standard sink base).

TIPS TO THE INSTALLER

#10 x 2 1/2" installation screws are furnished and packaged inside all cabinets. Proper wall stud or ceiling joist installation is essential for Wall and Peninsula cabinets to support weight. Whenever possible, cabinets should be attached to each other for additional strength. Excessive weight should not be put on cabinets hung by themselves. Shimming may be required to ensure proper alignment. Wallboard alone is not strong enough to support the cabinets.

Our Warranty does not cover damage caused by improper installation. Please be sure to install cabinets properly. If you have questions, please contact your representative or customer service.

NKBA Guidelines

kitchen planning guidelines

DOOR/ENTRY

- Door opening should be at least 32" wide, requiring a minimum 2' 10" wide door.

DOOR INTERFERENCE

- Entry door should not interfere with safe appliance operation or appliance doors.

DISTANCE BETWEEN WORK CENTERS

- With three work centers, the total distance traveled should not be more than 26' with no single leg of the triangle less than 4' or more than 9'.
- With more than three work centers, each additional travel distance to another work center should be no less than 4' or more than 9'. Each leg is measured from the center-front of the appliance/sink. No work triangle leg should intersect an island/peninsula by more than 12".

SEPARATING WORK CENTERS

- A tall obstacle should not separate two primary work centers. A properly recessed tall corner unit is acceptable.

WORK TRIANGLE TRAFFIC

- Major traffic patterns should not cross through the basic work triangle.

WORK AISLE

- The work aisle should be at least 42" for one cook and at least 48" for multiple cooks.

WALKWAY

- The walkway width should be at least 36".

TRAFFIC CLEARANCE AT SEATING

- Allow 32" of clearance from the table to wall/obstacle if no traffic passes behind a seated diner. If traffic passes behind the diner, allow at least 36" to edge past or 44" to walk past.

SEATING CLEARANCE

- 30" high tables/counters should allow a 24" wide by 18" deep space for each seated diner and at least 18" knee space.
- 36" high counters should allow a 24" wide by 15" deep space for each seated diner and at least 15" kneespace.
- 42" high counters should allow a 24" wide by 12" deep space for each seated diner and at least 12" kneespace.

CLEAN-UP/PREP SINK PLACEMENT

- With only one sink, locate it adjacent to or across from the cooking surface and refrigerator.

CLEAN-UP/PREP SINK LANDING AREA

- Include at least a 24" wide landing space on one side of the sink and 18" on the other.
- If all the countertop at the sink is not the same height, plan a 24" landing space on one side of the sink and 3" of countertop frontage on the other, both at the same height of the sink.

PREPARATION/WORK AREA

- Include a section of countertop at least 36" wide x 24" deep next to the sink for a work area.

DISHWASHER PLACEMENT

- Nearest edge of dishwasher should be within 36" of nearest edge of sink. Provide at least 21" of standing space between the edge of the dishwasher and countertop frontage/appliances/cabinets which are placed at a right angle to the dishwasher.

WASTE RECEPTACLES

- Include at least 2 waste receptacles, one near the sink and the other nearby for recycling.

AUXILIARY SINK

- Provide at least 3" of countertop frontage on one side of the auxiliary sink and 18" on the other side, both at the same height as the sink.

REFRIGERATOR LANDING AREA

- Include at least 15" of landing area on the handle side of the refrigerator, 15" on either side of a side-by-side refrigerator, 15" of landing space which is no more than 48" across from the front of the refrigerator, and 15" above or adjacent to any under-counter style refrigerator.

COOKING SURFACE LANDING AREA

- Include a minimum of 12" of landing area on one side of the cooking surface and 15" on the other.
- If cooking surface is at a different countertop height than the rest of the kitchen, then the 12" and 15" landing areas must be the same height as the cooking surface.
- For safety reasons, in an island or peninsula situation, the countertop should extend a minimum of 9" behind the cooking surface if the counter height is the same height as the cooking surface.

COOKING SURFACE CLEARANCE

- Allow 24" between the cooking surface and a protected noncombustible surface above it.
- At least 30" of clearance is required between the cooking surface and an unprotected/combustible surface above it.
- If a microwave/hood combination is used, then the manufacturer's specifications should be followed.

COOKING SURFACE VENTILATION

- A correctly sized, ducted ventilation system is recommended for all cooking surface appliances. The recommended minimum is 150 CFM.
- Code requires that the manufacturer's specifications be followed. Minimum exhaust rate for a ducted hood is 100 CFM and must be ducted to the outside.
- Make-up air may need to be provided. Refer to local codes.

COOKING SURFACE SAFETY

- Do not locate cooking surface under an operable window.
- Window treatments above cooking surface should not use flammable materials.
- Place a fire extinguisher near the kitchen exit away from cooking equipment.

MICROWAVE OVEN PLACEMENT

- The ideal location for the bottom of the microwave is 3" below the principle user's shoulder, but no more than 54" above the floor.

MICROWAVE LANDING AREA

- Provide at least 15" above, below, or adjacent to the handle side of a microwave oven.

OVEN LANDING AREA

- Include at least 15" next to or above the oven.
- A 15" landing area that is not more than 48" away is also acceptable as long as the oven does not open into a walkway.

COMBINING LANDING AREAS

- If two landing areas are adjacent to one another, determine a new minimum for the two by taking the longer of the two and adding 12".

(cont'd)

kitchen planning guidelines (cont'd)

COUNTERTOP SPACE

- A total of 158" of countertop frontage, 24" deep, with at least 15" clearance above is needed to accommodate all landing, preparation, work, and storage areas.

COUNTERTOP EDGES

- Clipped or round corners, rather than sharp edges, are recommended on all counters.

STORAGE

- The recommended total shelf/drawer frontage for a small kitchen (less than 150 square feet) is 1400", for a medium kitchen (151 to 350 square feet) is 1700", and for a large kitchen (greater than 350 square feet) is 2000".

Sizes:	S	M	L
Wall	300"	360"	360"
Base	520"	615"	660"
Drawer	360"	400"	525"
Pantry	180"	230"	310"
Misc.	40"	95"	145"

- The totals for wall, base, drawer, and pantry shelf/drawer frontage can be adjusted upward or downward as long as the recommended total stays the same.

STORAGE AT CLEAN-UP/PREP SINK

- The recommended total for a small kitchen is 400", a medium kitchen is 480", a large kitchen is 560", and should be located within 72" of the centerline of the main clean-up/prep sink.

CORNER CABINET STORAGE

- At least one corner cabinet should include a functional storage device.

ELECTRICAL RECEPTACLES

- GFCI (Ground-Fault-Circuit-Interrupter) protection is required on all receptacles servicing countertop surfaces within the kitchen.

LIGHTING

- Every work surface should be well illuminated. At least one wall switch-controlled light must be placed at the entrance.
- Window/skylight area, equal to at least 8% of the total square footage of the kitchen, or a total living space which includes a kitchen, is required.

bathroom planning guidelines

DOOR/ENTRY

- Doorway opening should be at least 32", requiring a minimum 2' 10" wide door.

DOOR INTERFERENCE

- The door area should include clear floor space for maneuvering which varies according to the type of door and the direction of the approach.

CEILING HEIGHT

- Bathroom floor to ceiling minimum height is 80". A shower or tub with a shower head shall have a minimum floor to ceiling height of 80" above a minimum area 30" x 30" at the shower head.

CLEAR SPACE

- Plan a clear space of 30" from the front edge of all fixtures to any opposite bath fixture, wall, or obstacle.
- A minimum space of at least 21" is required in front of a lavatory, toilet, bidet, and tub, with a 24" minimum space in front of a shower entry.

SINGLE LAVATORY PLACEMENT

- The distance from the centerline of the lavatory to the sidewall/tall obstacle should be at least 20".
- The minimum distance required is 15". The minimum distance required between a wall and the edge of a lavatory is 4".

DOUBLE LAVATORY PLACEMENT

- The distance between the centerlines of two lavatories should be at least 36".
- The minimum distance required is 30".
- The minimum distance required between the edges of two lavatories is 4".

LAVATORY/VANITY HEIGHT

- The height for a lavatory varies from 32" to 43" to fit the user.

COUNTERTOP EDGES

- Clipped or round corners, rather than sharp edges, are recommended on all counters.

SHOWER SIZE

- The interior shower size should be at least 36" x 36". The minimum interior shower size required is 30" x 30".

STORAGE

- Provide adequate, accessible storage for toiletries, bath linens, grooming and general bathroom supplies.
- Storage of frequently used items should be 15" to 48" above floor.

ELECTRICAL RECEPTACLES

- All GFCI receptacles should be located at electrical appliance points of use.

Load bearing floors and shelves meet KCMA standards of 15 lbs. per square foot. Warranty does not cover overloading beyond this point.

To view a complete and updated list of the NKBA Guidelines, visit <https://nkba.org/info/guidelines>

© Copyright 2010 National Kitchen & Bath Association

Notes

Wood Specifications

When choosing a finish, one needs to consider the substrate or material that is to be used in the cabinet construction. The substrate material is the first characteristic to affect finish. Since no two trees produce the same type of grain pattern or mineral characteristic, the wood grain is unique to a tree (i.e., fingerprints). The amount of allowable mineral and natural variation is outlined by the NHLA (National Hardwood Lumber Association). The type and color of mineral and grain are greatly dependent on the location of where the tree grew in the United States, type of soil and location in the forest. Diamond Edge does not sort product for certain color, grain or mineral variation. Unique characteristics of wood enhance the beauty of every kitchen. As hardwood ages, it will darken when exposed to different types of light. Color differences or changes in wood can also be caused by exposure to harsh chemicals, extreme heat or other contributing external conditions. Additionally, wood species exhibit other defining characteristics, such as mineral deposits/streaks, knots, sap runs, pin holes and wormholes. These markings make the wood unique and contribute to its enduring beauty. Neither Diamond Edge nor your Diamond Edge dealer can be responsible for the type or degree of variations which may actually characterize your cabinetry.

- Alder has a straight fine textured grain similar to Cherry and Maple. Although classified as a hardwood, it is moderately light in weight and considerably softer than other species. Therefore, care must be taken as it will dent and mar easily. Alder may exhibit grain and color variations, sapwood can be distinguishable from the heartwood, tight pin knots are sometimes present.
- Rustic Alder is characterized by its light brown and reddish undertones and may contain a variety of pin holes, open and closed knots of various sizes and colors, small cracks, bird pecks, mineral streaks, and grain variation. Some knots may have small holes through the panel. Larger holes will not be filled. In addition, the wood will contain color difference caused by variations in minerals found in the soil, creating visible mineral tracks.

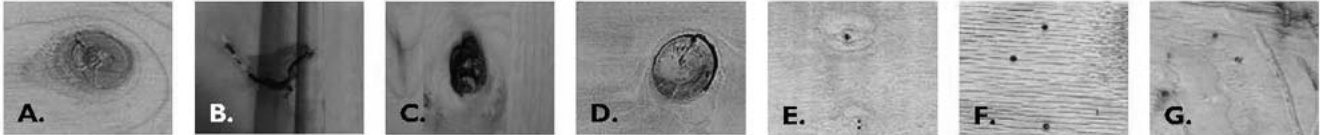

- A. Sound Closed Knot (not moveable) – Expected in Rustic Alder up to approximately 3” diameter.
- B. Sound Knot with Cracks – Expect sound knots with open cracks up to approximately 1” in length.
- C. Open Knot (through door) – Expected in Rustic Alder with open area up to approximately 3/4” diameter. Note: 3/4” diameter is about the size of a penny. Holes created by open knots pass completely through the door and are desirable for this rustic look.
- D. Unsound Knot (moveable core) – Not to be expected.
- E. Knot Cluster (cluster of tight sound knots) – To be expected in Rustic Alder.
- F. Worm Holes/Pin Holes (can go through door) – Can be expected on Rustic Alder up to approximately 1/4” diameter.
- G. Worm Tracks – Can be expected on Rustic Alder in sizes up to approximately 1/8” wide by 8” long.

NOTE: Doors, drawer fronts, and certain mouldings will utilize Rustic Alder while other parts may utilize Alder or other materials. For mouldings/embellishments and wood hood availability see respective sections.

✍️ Signed agreement required with Rustic Alder wood type; see page V•7.

- Cherry is characterized by its red undertones, but may vary in color from white to a deep, rich brown. This color variation can occur in a single door panel. Cherry is a close-grained wood with fairly uniform texture, revealing pin knots and curly graining. All wood will age with time and the finish will darken. This is especially true for Cherry. This is a sought-after quality in Cherry cabinetry, and those who select it expect this evolution.
- Maple is a close-grained hardwood that is predominately white to creamy-white in color, with occasional reddish-brown tones. While Maple typically features uniform graining as compared to other wood species, characteristic markings may include fine brown lines, wavy or curly graining, bird’s eye dots and mineral streaks. These traits are natural and serve to enhance Maple’s natural beauty.
- MDF (Medium Density Fiberboard) is an engineered wood product composed of wood fibers and resin compressed to create a smooth uniform surface with a consistent core. MDF features no naturally occurring wood characteristics (grain patterns, knots or mineral streaks) and when painted, is more resistant than solid hardwoods to environmentally-induced warping, expansion and contraction. MDF door and drawer front components will be MDF. Face frames and box parts utilize Maple paint material, and trim and panels utilize Maple species. Timeworn, Extra Timeworn, Hewn, and Extra Hewn finish techniques are not available.
- Quartersawn Oak features a tight grain or “comb grain”. This grain will reveal a fairly straight pattern that can range from very close together to quite far apart, displaying a slight curve in the grain on the verge of creating a cathedral pattern similar to that of flat cut Oak. Medullary rays, sometimes called “tiger striping” or “flecking” may occur. These rays are a common characteristic of Oak and are evident as shiny patches or scars which cut across the grain of the wood. They reflect light differently than the general grain, especially when finished. They are not usually seen in standard Oak. These medullary rays will occur at random and are not considered a defect.
- Walnut wood features smooth grain, with color variation that can range from deep chocolate, to lighter tones of red/gray/brown. Sapwood areas will be present within Walnut and are lighter in hue, from yellow to light brown. Walnut ages opposite of expectation, becoming lighter and more mellow in color over time and with exposure to light.

No matter which species you choose for your new kitchen or bath cabinetry, please keep in mind that no two pieces of wood are exactly the same. Stains are likely to exaggerate the difference between open and closed grains and other markings in wood. Grain variation and color change should be expected. As hardwood ages, it will darken when exposed to different types of light. Color differences or changes in wood can also be caused by exposure to harsh chemicals, extreme heat or other contributing external conditions. Additionally, wood species exhibit other defining characteristics, such as mineral deposits/streaks, knots, sap runs, pin holes and wormholes. These markings make the wood unique and contribute to its enduring beauty.

In keeping with our practice of continuous product improvement, Diamond Cabinetry may adjust specifications in design and materials as conditions require. Some components may utilize differing materials to ensure a high-quality product in all applications.

Notes

Profile Selection

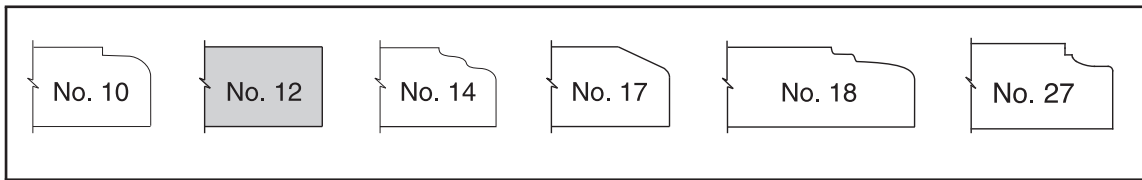

#12 Profile Design Tip

It is not required to specify 1/8" EXL and/or EXR on cabinets with the #12 profile unless it meets the criteria as shown below.

For full function and access, always use 1/8" EXL and/or EXR in the following design applications:

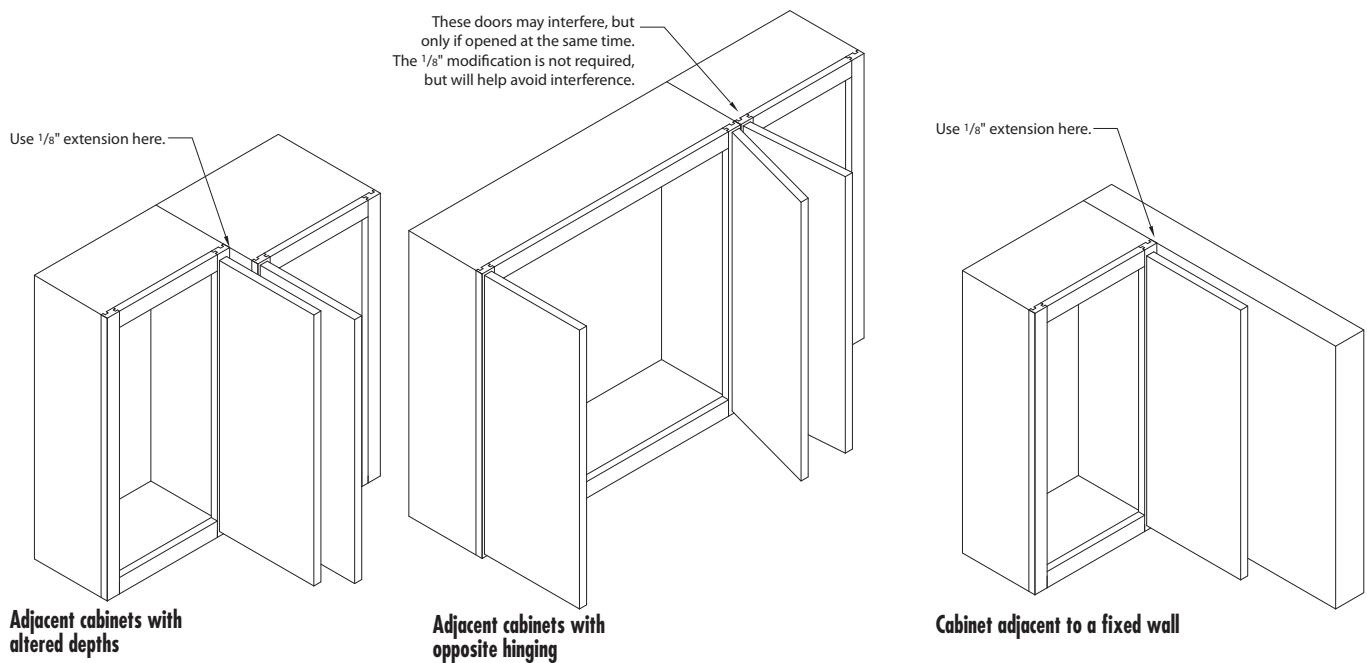

Other applications may require the 1/8" EXL/EXR modification. For example, when cabinets are installed adjacent to a wall.

Full Overlay Styles

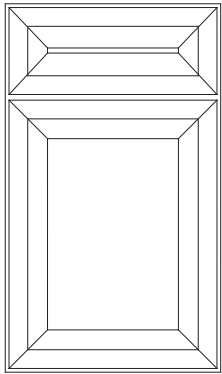

Brooks

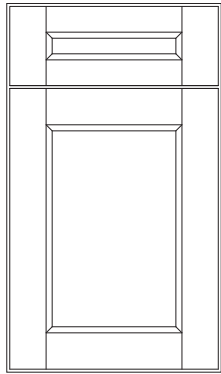

Caldera **NEW**

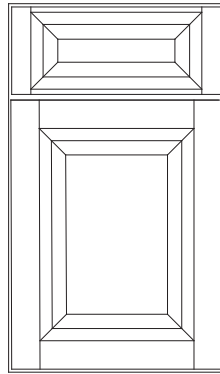

Daxton

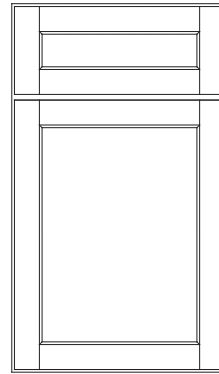

Gunther

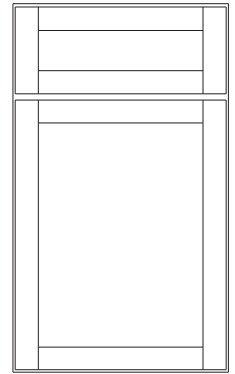

Karis

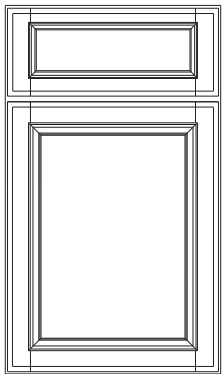

Langley

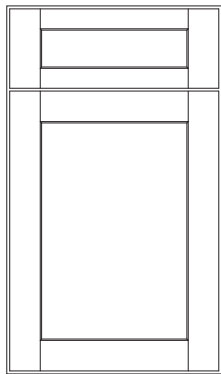

Montgomery **NEW**

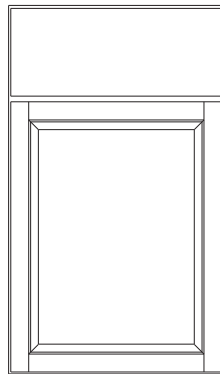

Shona

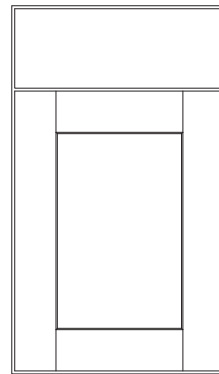

Sumner **NEW**

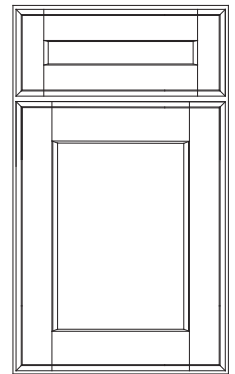

Tackett

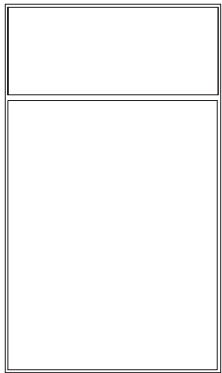

Trystan **NEW**

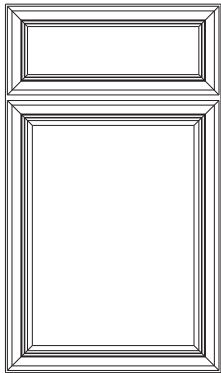

Vesta

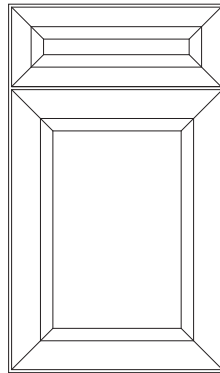

Wells **NEW**

Brooks Collection*

Full Overlay Door Styles

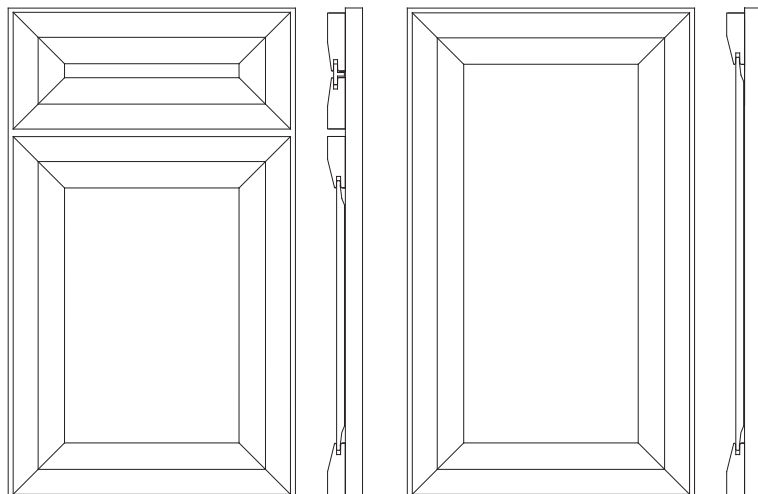

Square Base Cabinet

Square Wall Cabinet

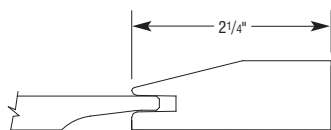

Door Rail/Center Panel Detail

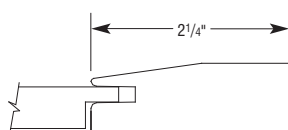

Drawer Rail/Center Panel Detail

Wood Species

Alder	3
Cherry	5
Maple	3
Quartersawn Oak	5
Rustic Alder	3
Walnut	6

Price Column

Outside Profile Selections



Special Notes

- 5-piece mitered drawer front with flat center panel
- Drawer fronts smaller than 5 3/4" high will have slab front
- 5-piece mitered solid reverse raised panel door

Design Notes

- Solid slab drawer front (DFS LB) available. See page G•11.
- Solid slab drawer front top (DFS LB T) available. See page G•12.
- Mullion doors and Prairie Mullion doors not available.
- 1/8" EXL and/or EXR options may be required. See page D•1 for details.

Caldera Collection*

NEW Full Overlay Door Styles

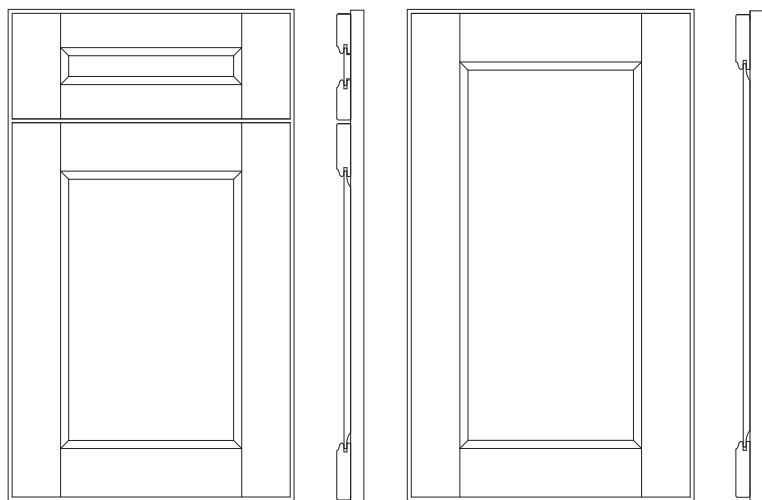

Square Base Cabinet

Square Wall Cabinet

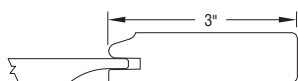

Door Rail/Center Panel Detail

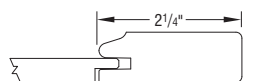

Drawer Rail/Center Panel Detail < 7 1/4"

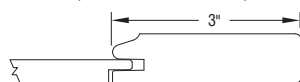

Drawer Rail/Center Panel Detail ≥ 7 1/4"

Wood Species

Alder	3
Cherry	5
Maple	3
Quartersawn Oak	5
Rustic Alder	3
Walnut	6

Price Column

Outside Profile Selections*

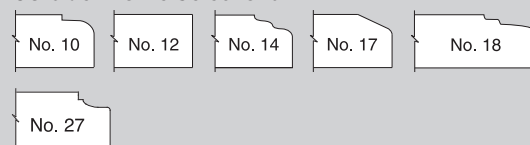

*Profile No. 12 shown

Special Notes

- 5-piece flat center panel drawer front
- Drawer fronts smaller than 5 3/4" high will have slab front
- Doors smaller than 9 25/32" wide require a 2 29/32" end rail
- Doors under 8 9/16" will be a slab
- Solid reverse raised panel door

Design Notes

- Solid slab drawer front (DFS LB) available. See page G•11.
- Solid slab drawer front top (DFS LB T) available. See page G•12.
- 1/8" EXL and/or EXR options may be required. See page D•1 for details.

*When Maple painted finishes (Paints, Sherwin-Williams or Brushed Technique) are specified, the center panels of the selected style may be constructed of Medium Density Fiberboard (MDF). MDF provides a smoother finish when painted, and is more resistant to warping, expansion, and contraction.

Door Styles

Daxton Collection*

Full Overlay Door Styles

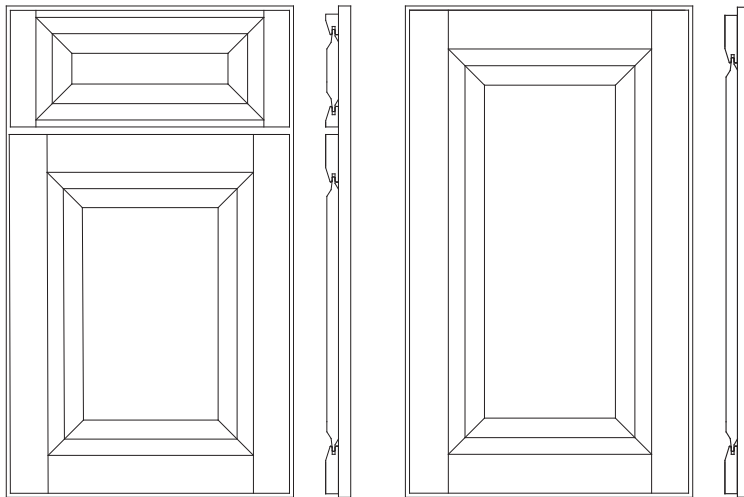

Square Base Cabinet

Square Wall Cabinet

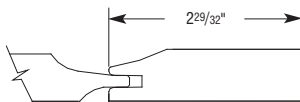

Door Rail/Center Panel Detail

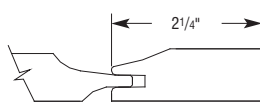

Drawer Side Rail/Center Panel Detail

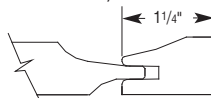

Drawer Top/Bottom Rail/Center Panel Detail

Wood Species

Alder
Cherry
Maple
Quartersawn Oak
Rustic Alder
Walnut

Price Column

2
4
2
4
2
6

Outside Profile Selections

No. 12

Special Notes

- 5-piece raised center panel drawer front
- Drawer end rails are 2 1/4" and crossrails are 1 1/4" (finished width). This rule will apply on all 4 1/4", 4 1/2", and 5" high drawer openings.
- Any drawer openings larger than 4 1/2" high will utilize 2 1/4" end rails and crossrails
- Drawer fronts smaller than 5 3/4" high will have slab front
- Solid double raised center panel door

Design Notes

- Solid slab drawer front (DFSLB) available. See page G•11.
- Solid slab drawer front top (DFSLBT) available. See page G•12.
- Mullion doors and Prairie Mullion doors not available
- 1/8" EXL and/or EXR options may be required. See page D•1 for details.

Gunther Collection*

Full Overlay Door Styles

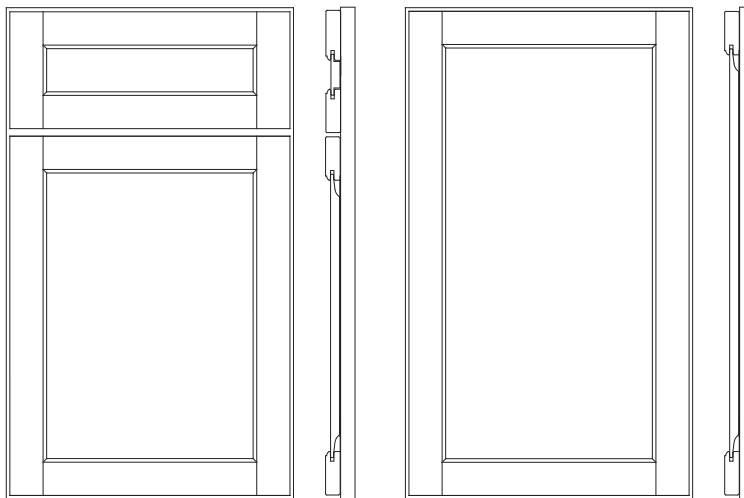

Square Base Cabinet

Square Wall Cabinet

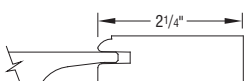

Door Rail/Center Panel Detail

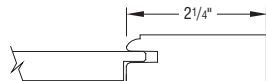

Drawer Rail/Center Panel Detail

Wood Species

Alder
Cherry
Maple
Quartersawn Oak
Rustic Alder
Walnut

Price Column

1
3
1
3
1
5

Outside Profile Selections*

No. 10

No. 12

No. 14

No. 17

No. 18

No. 27

*Profile No. 12 shown

Special Notes

- 5-piece flat center panel drawer front
- Drawer fronts smaller than 5 3/4" high will have slab front
- 5-piece solid reverse raised panel door

Design Notes

- Solid slab drawer front (DFSLB) available. See page G•11.
- Solid slab drawer front top (DFSLBT) available. See page G•12.
- 1/8" EXL and/or EXR options may be required. See page D•1 for details.

*When Maple painted finishes (Paints, Sherwin-Williams or Brushed Technique) are specified, the center panels of the selected style may be constructed of Medium Density Fiberboard (MDF). MDF provides a smoother finish when painted, and is more resistant to warping, expansion, and contraction.

Karis Collection*

Full Overlay Door Styles

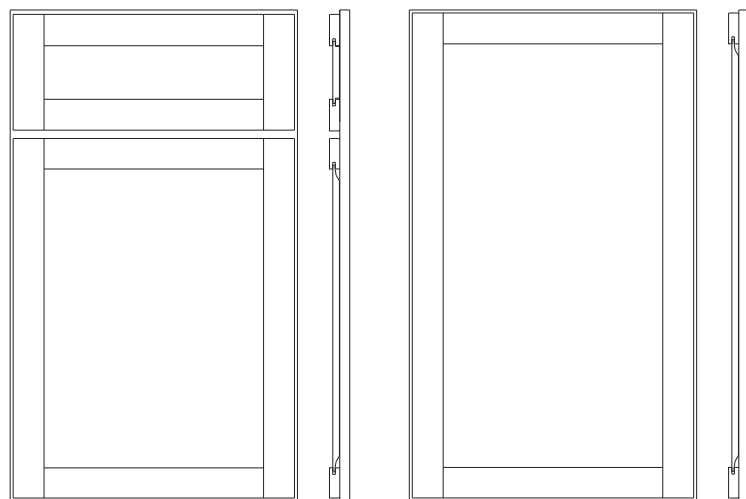

Square Base Cabinet

Square Wall Cabinet

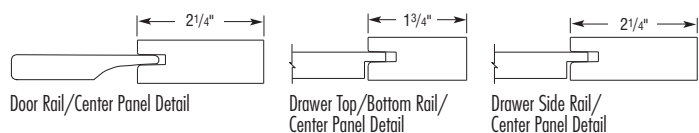

Door Rail/Center Panel Detail

Drawer Top/Bottom Rail/Center Panel Detail

Drawer Side Rail/Center Panel Detail

Wood Species

Alder	1
Cherry	3
Maple	1
Quartersawn Oak	3
Rustic Alder	1
Walnut	5

Price Column

Outside Profile Selections*

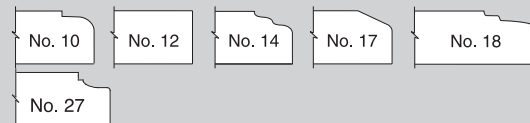

*Profile No. 12 shown

Special Notes

- Drawer fronts smaller than 4 1/2" high will have slab front
- 5-piece flat center panel drawer front
- 5-piece drawer front will utilize a 1 3/4" wide top and bottom rail
- Solid reverse raised panel door

Design Notes

- Solid slab drawer front (DFSLB) available. See page G•11.
- Solid slab drawer front top (DFSLBT) available. See page G•12.
- 1/8" EXL and/or EXR options may be required. See page D•1 for details.

Langley Collection*

Full Overlay Door Styles

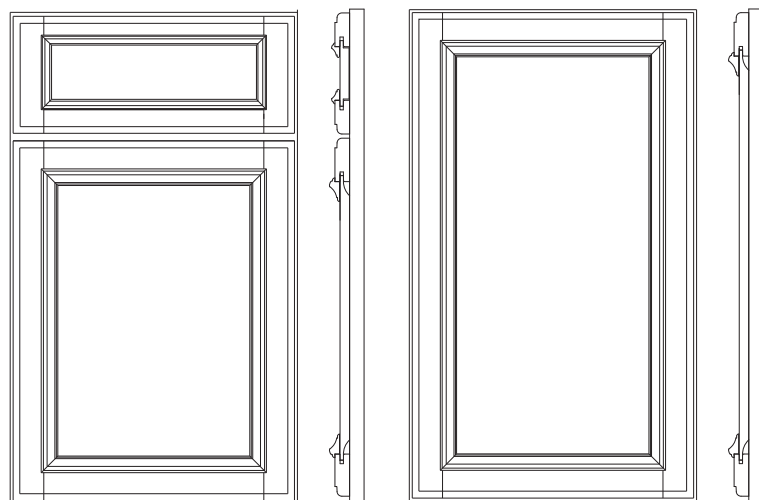

Square Base Cabinet

Square Wall Cabinet

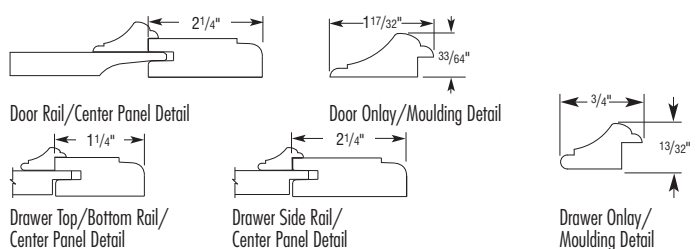

Door Rail/Center Panel Detail

Door Onlay/Moulding Detail

Drawer Top/Bottom Rail/Center Panel Detail

Drawer Side Rail/Center Panel Detail

Drawer Onlay/Moulding Detail

Wood Species

Alder	5
Cherry	6
Maple	5
Quartersawn Oak	6
Rustic Alder	5
Walnut	7

Price Column

Outside Profile Selections*

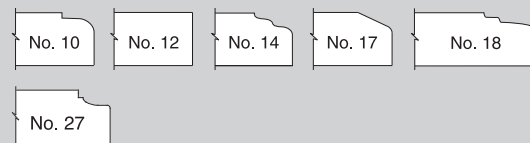

*Profile No. 10 shown

Special Notes

- Bold onlay moulding applied to door; larger than drawer
- 9-piece flat center panel drawer front with onlay moulding
- 9-piece solid reverse raised panel door
- Drawer fronts smaller than 5 3/4" high or drop front applications will have slab front

Design Notes

- Solid slab drawer front (DFSLB) available. See page G•11.
- Solid slab drawer front top (DFSLBT) available. See page G•11.
- Mullion doors and Prairie Mullion doors not available
- 1/8" EXL and/or EXR options may be required. See page D•1 for details.

*When Maple painted finishes (Paints, Sherwin-Williams or Brushed Technique) are specified, the center panels of the selected style may be constructed of Medium Density Fiberboard (MDF). MDF provides a smoother finish when painted, and is more resistant to warping, expansion, and contraction.

Door Styles

Montgomery Collection*

NEW Full Overlay Door Styles

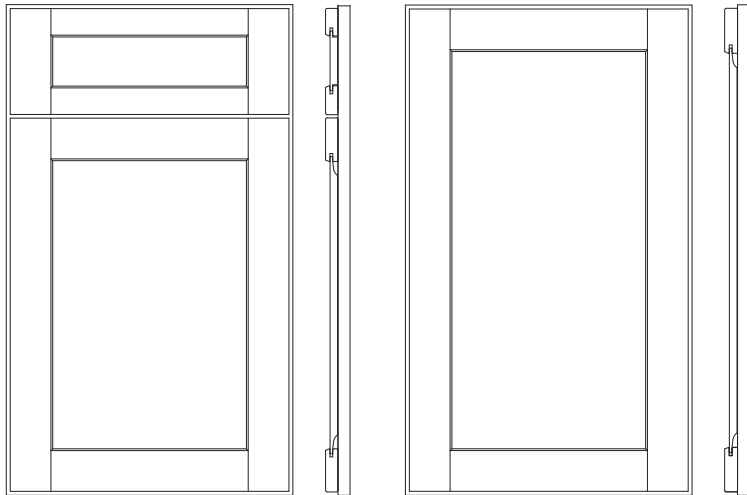

Square Base Cabinet

Square Wall Cabinet

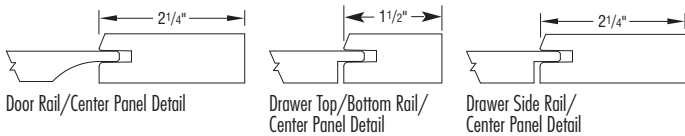

Door Rail/Center Panel Detail

Drawer Top/Bottom Rail/Center Panel Detail

Drawer Side Rail/Center Panel Detail

Wood Species

Alder	1
Cherry	3
Maple	1
Quartersawn Oak	3
Rustic Alder	1
Walnut	5

Price Column

Outside Profile Selections*

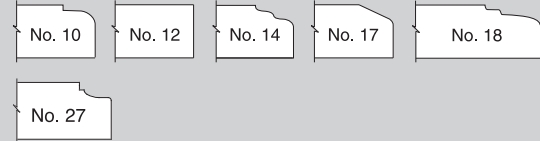

*Profile No. 12 shown

Special Notes

- 5-piece flat center panel drawer front
- Drawer fronts smaller than 5 3/4" high will have slab front
- Solid reverse raised panel door

Design Notes

- Solid slab drawer front (DFS LB) available. See page G•11.
- Solid slab drawer front top (DFS LB T) available. See page G•12.
- 1/8" EXL and/or EXR options may be required. See page D•1 for details.

Shona Collection*

Full Overlay Door Styles

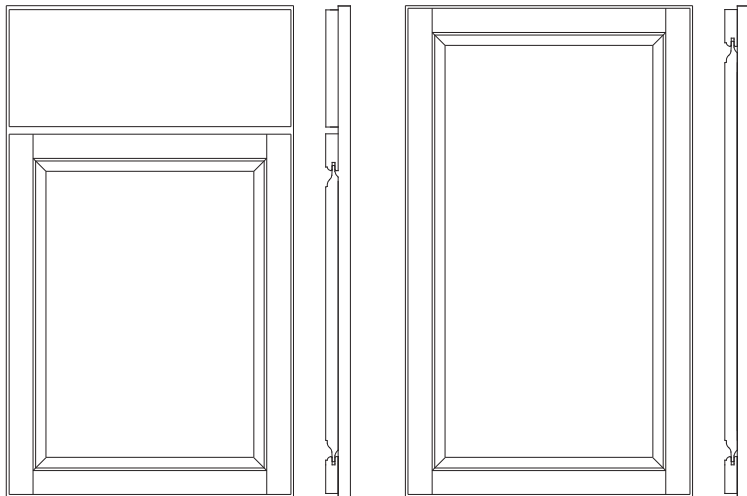

Square Base Cabinet

Square Wall Cabinet

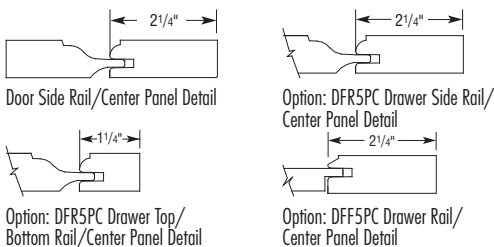

Door Side Rail/Center Panel Detail

Option: DFR5PC Drawer Side Rail/Center Panel Detail

Option: DFR5PC Drawer Top/Bottom Rail/Center Panel Detail

Option: DFF5PC Drawer Rail/Center Panel Detail

Wood Species

Alder	1
Cherry	3
Maple	1
Quartersawn Oak	3
Rustic Alder	1
Walnut	5

Price Column

Outside Profile Selections*



*Profile No. 12 shown

Special Notes

- Solid slab drawer front
- 5-piece solid double raised panel door

Design Notes

- 5-piece flat center panel drawer front (DFF5PC) available. Some exceptions may apply. See page G•10 for details.
- 5-piece flat center panel drawer front with slab top (DFF5PCSLBT) available. Some exceptions may apply. See page G•11 for details.
- 5-piece double raised panel drawer front (DFR5PC) available. Some exceptions may apply. See page G•11 for details.
- 5-piece double raised panel drawer front with slab top (DFR5PCSLBT) available. Some exceptions may apply. See page G•10 for details.
- 1/8" EXL and/or EXR options may be required. See page D•1 for details.

*When Maple painted finishes (Paints, Sherwin-Williams or Brushed Technique) are specified, the center panels of the selected style may be constructed of Medium Density Fiberboard (MDF). MDF provides a smoother finish when painted, and is more resistant to warping, expansion, and contraction.

Sumner Collection*

NEW Full Overlay Door Styles

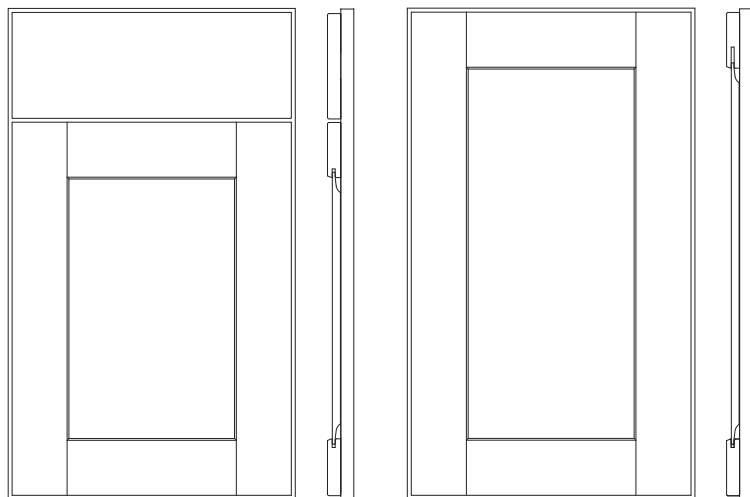

Square Base Cabinet

Square Wall Cabinet

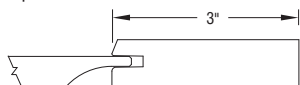

Door Rail/Center Panel Detail

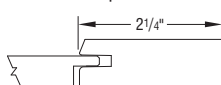

Option: DFF5PC Drawer Rail/
Center Panel Detail < 7 1/4"

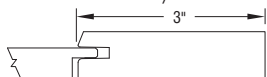

Option: DFF5PC Drawer Rail/
Center Panel Detail ≥ 7 1/4"

Wood Species

Alder	3
Cherry	5
Maple	3
Quartersawn Oak	5
Rustic Alder	3
Walnut	6

Price Column

Outside Profile Selections*

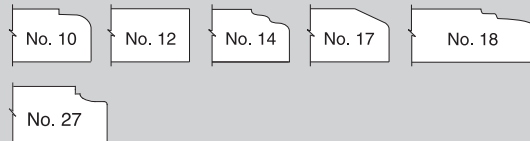

*Profile No. 12 shown

Special Notes

- Solid slab drawer front
- Doors smaller than 8 9/16" wide require a 2 1/4" end rail
- Solid reverse raised panel door
- Wide-rail design

Design Notes

- 5-piece flat center panel drawer front (DFF5PC) available. Some exceptions may apply. See page G•10 for details.
- 5-piece flat center panel drawer front with slab top (DFF5PCSLBT) available. Some exceptions may apply. See page G•11 for details.
- 1/8" EXL and/or EXR options may be required. See page D•1 for details.

Tackett Collection*

Full Overlay Door Styles

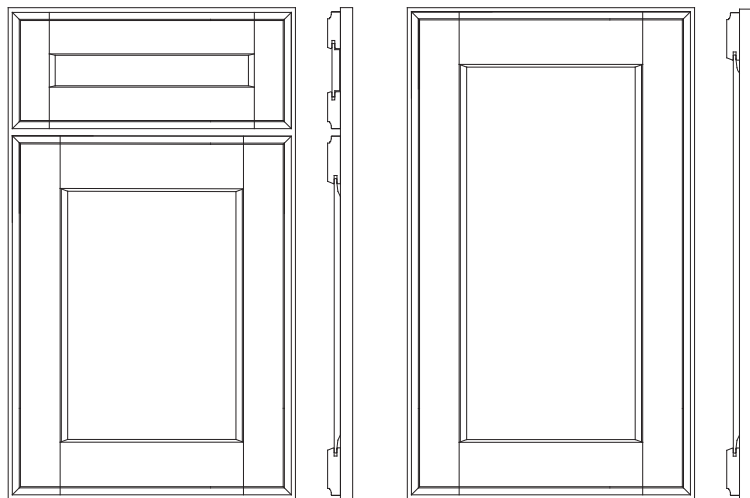

Square Base Cabinet

Square Wall Cabinet

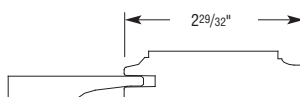

Door Side Rail/Center Panel Detail

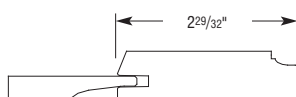

Door Top/Bottom Rail/Center Panel Detail

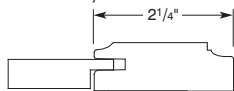

Drawer Side Rail/Center Panel Detail

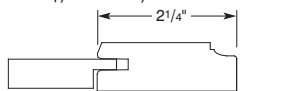

Drawer Top/Bottom Rail/Center Panel Detail

Wood Species

Alder	2
Cherry	4
Maple	2
Quartersawn Oak	4
Rustic Alder	2
Walnut	6

Price Column

Outside Profile Selections*

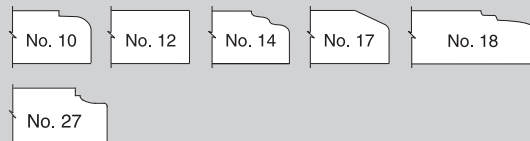

*Profile No. 27 shown

Special Notes

- 5-piece flat center panel drawer front
- Drawer fronts smaller than 5 3/4" high will have slab front
- 5-piece solid reverse raised panel door

Design Notes

- Solid slab drawer front (DFSLB) available. See page G•11.
- Solid slab drawer front top (DFSLBT) available. See page G•11.
- Mullion doors and Prairie Mullion doors not available
- 1/8" EXL and/or EXR options may be required. See page D•1 for details.

*When Maple painted finishes (Paints, Sherwin-Williams or Brushed Technique) are specified, the center panels of the selected style may be constructed of Medium Density Fiberboard (MDF). MDF provides a smoother finish when painted, and is more resistant to warping, expansion, and contraction.

Door Styles

Trystan Collection*

NEW Full Overlay Door Styles

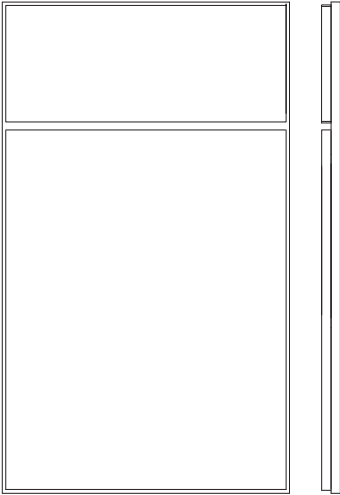

Square Base Cabinet

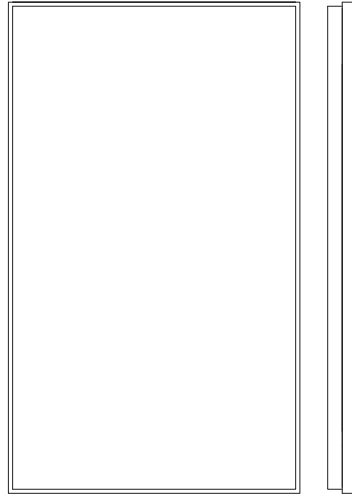

Square Wall Cabinet

Wood Species

Alder	4
Cherry	6
Maple	4
MDF	1
Quartersawn Oak	6
Walnut	7

Price Column

Outside Profile Selections

No. 12

Special Notes

- Veneer slab drawer front, except when selected with MDF species
- Veneer slab door, except when selected with MDF species
- Grain direction is vertical on doors and horizontal on drawer fronts
- Not available with Hewn, Extra Hewn, Timeworn, or Extra Timeworn
- There will be an additional 2 week lead time on all species except MDF
- Mullion doors and Prairie Mullion doors not available
- MDF door and drawer front components will be MDF. Face frame and box parts utilize maple paint material, and trim and panels utilize maple species.

Design Notes

- 1/8" EXL and/or EXR options may be required. See page D•1 for details.

Vesta Collection*

Full Overlay Door Styles

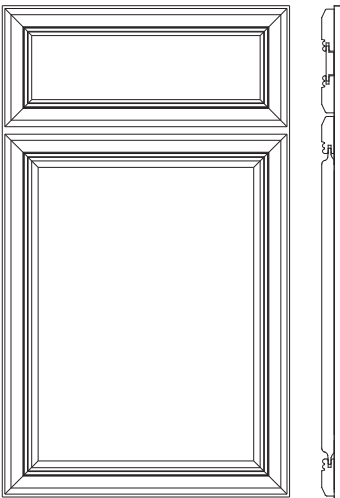

Square Base Cabinet

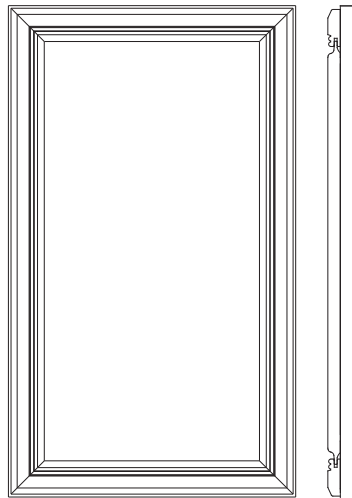

Square Wall Cabinet

Wood Species

Alder	2
Cherry	4
Maple	2
Quartersawn Oak	4
Rustic Alder	2
Walnut	6

Price Column

Outside Profile Selections*

No. 10

No. 12

No. 14

No. 17

No. 18

No. 27

*Profile No. 17 shown

Special Notes

- Double bead door and drawer rails
- 5-piece mitered drawer front with flat center panel
- Drawer fronts smaller than 5 3/4" high will have slab front
- 5-piece mitered door with solid double raised center panel

Design Notes

- Solid slab drawer front (DFS LB) available. See page G•11.
- Solid slab drawer front top (DFS LB T) available. See page G•12.
- 1/8" EXL and/or EXR options may be required. See page D•1 for details.

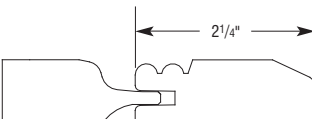

Door Rail/Center Panel Detail

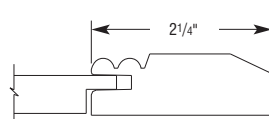

Drawer Rail/Center Panel Detail

*When Maple painted finishes (Paints, Sherwin-Williams or Brushed Technique) are specified, the center panels of the selected style may be constructed of Medium Density Fiberboard (MDF). MDF provides a smoother finish when painted, and is more resistant to warping, expansion, and contraction.

Wells Collection*

NEW Full Overlay Door Styles

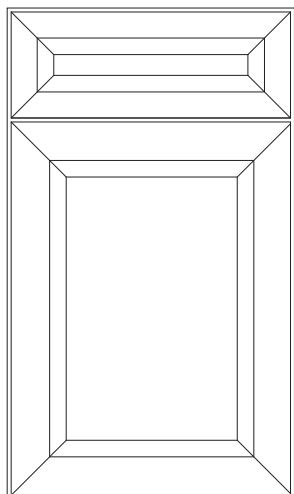

Square Base Cabinet

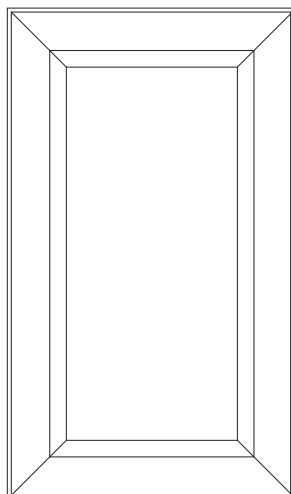

Square Wall Cabinet



Wood Species

Alder	4
Cherry	6
Maple	4
Quartersawn Oak	6
Rustic Alder	4
Walnut	7

Price Column

Outside Profile Selections

No. 12

Special Notes

- 5-piece mitered flat center panel drawer front
- Drawer fronts smaller than 5 3/4" high will have slab front
- 5-piece mitered solid reverse raised panel door
- Mullion doors and Prairie Mullion doors not available

Design Notes

- Solid slab drawer front (DFS LB) available. See page G•11.
- Solid slab drawer front top (DFS LBT) available. See page G•12.
- 1/8" EXL and/or EXR options may be required. See page D•1 for details.

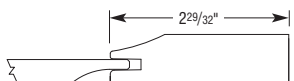

Door Rail/Center Panel Detail

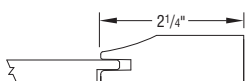

Drawer Rail/Center Panel Detail < 7 1/4"

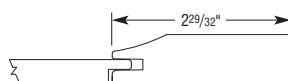

Drawer Rail/Center Panel Detail ≥ 7 1/4"

*When Maple painted finishes (Paints, Sherwin-Williams or Brushed Technique) are specified, the center panels of the selected style may be constructed of Medium Density Fiberboard (MDF). MDF provides a smoother finish when painted, and is more resistant to warping, expansion, and contraction.

Inset and Beaded Inset Door Styles

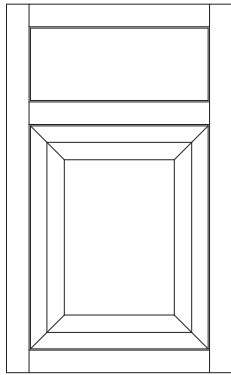

Brooks
Inset

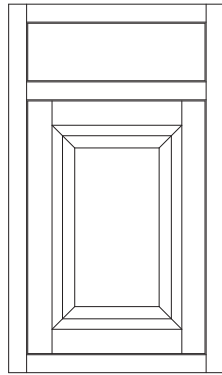

Daxton
Inset

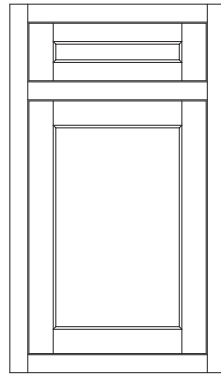

Gunther
Inset

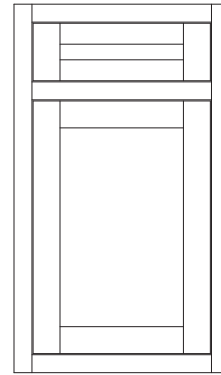

Karis
Inset

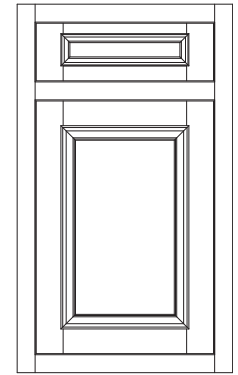

Langley
Inset

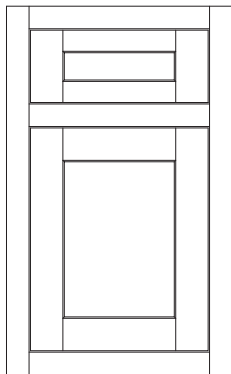

Montgomery
Inset **NEW**

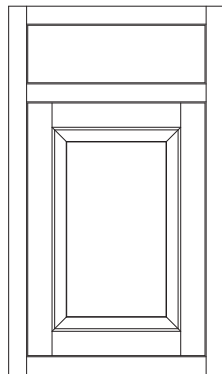

Shona
Inset

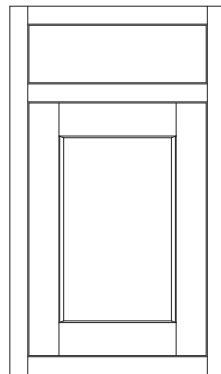

Tackett
Inset

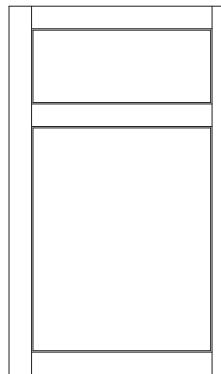

Trystan
Inset **NEW**

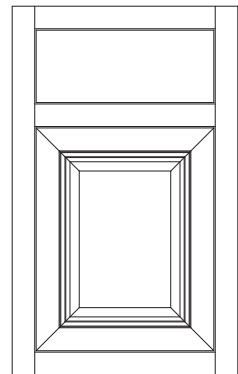

Vesta
Inset

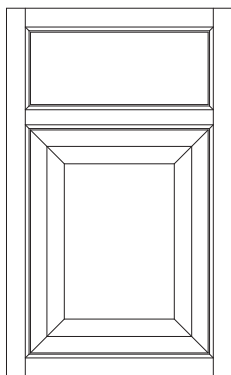

Brooks
Beaded Inset

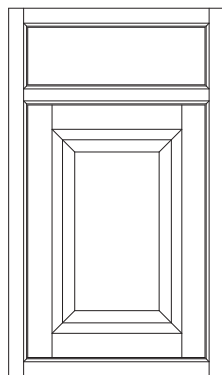

Daxton
Beaded Inset

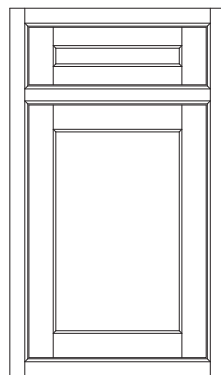

Gunther
Beaded Inset

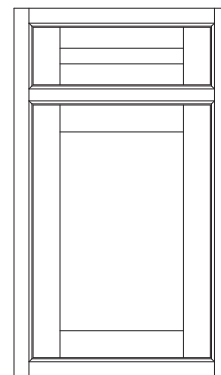

Karis
Beaded Inset

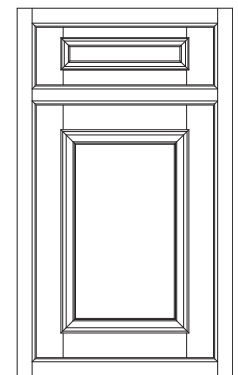

Langley
Beaded Inset

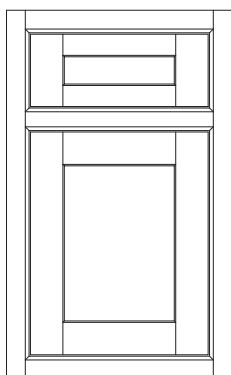

Montgomery
Beaded Inset **NEW**

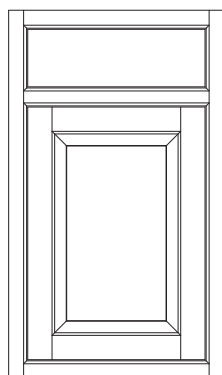

Shona
Beaded Inset

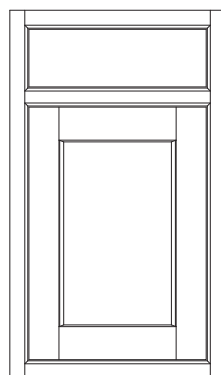

Tackett
Beaded Inset

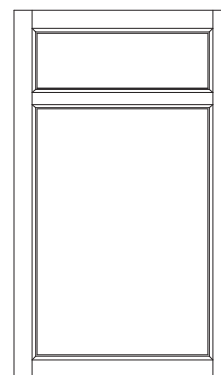

Trystan
Beaded Inset **NEW**

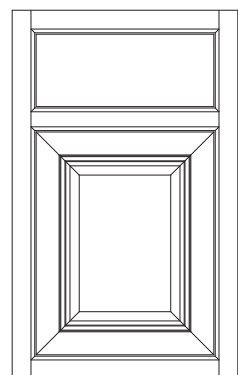

Vesta
Beaded Inset

Brooks Collection

Inset Door Styles*

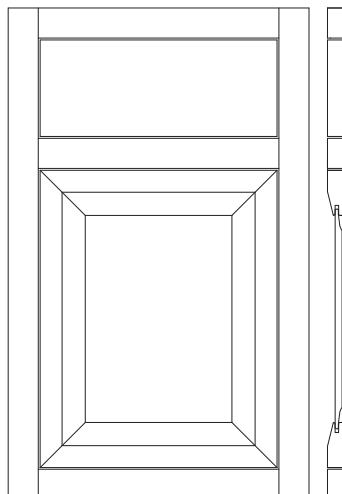

Square Base Cabinet

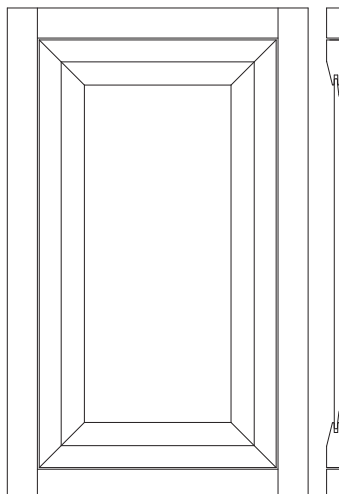

Square Wall Cabinet

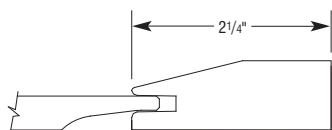

Door Rail/Center Panel Detail

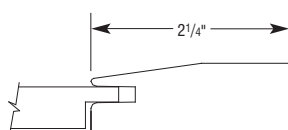

Option: DFF5PCINS Drawer Rail/Center Panel Detail

Wood Species

Alder	3+15%
Cherry	5+15%
Maple	3+15%
Quartersawn Oak	5+15%
Rustic Alder	3+15%
Walnut	6+15%

Price Column

Outside Profile Selections

No. 12

Special Notes

- Solid slab drawer front
- Solid reverse raised center panel door

Design Notes

- Mullion and Prairie Mullion doors not available.
- Finial Hinges (IFAB, IFBN, IFMB, IFORB) available on Profile #12 only. See page G•12 for details.
- Drawer Front Flat 5-piece Inset (DFF5PCINS) available. Some exceptions may apply. See page G•10 for details.

Beaded Inset Door Styles*

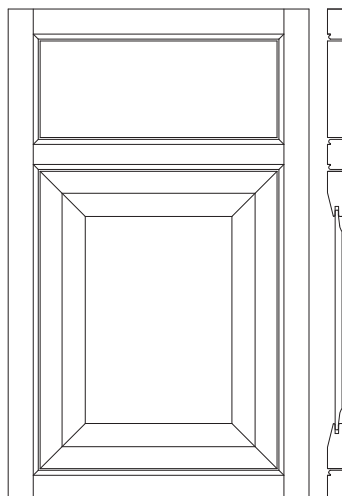

Square Base Cabinet

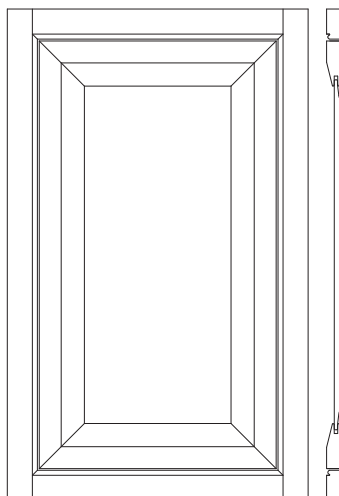

Square Wall Cabinet

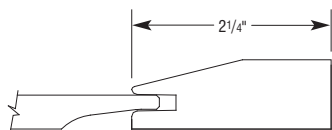

Door Rail/Center Panel Detail

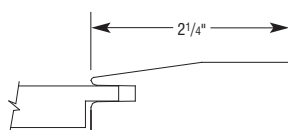

Option: DFF5PCINS Drawer Rail/Center Panel Detail

Wood Species

Alder	3+15%
Cherry	5+15%
Maple	3+15%
Quartersawn Oak	5+15%
Rustic Alder	3+15%
Walnut	6+15%

Price Column

Outside Profile Selections

No. 12

Special Notes

- Solid slab drawer front
- Solid reverse raised center panel door

Design Notes

- Mullion and Prairie Mullion doors not available.
- Finial Hinges (IFAB, IFBN, IFMB, IFORB) available on Profile #12 only. See page G•12 for details.
- Drawer Front Flat 5-piece Inset (DFF5PCINS) available. Some exceptions may apply. See page G•10 for details.

*When Maple painted finishes (Paints, Sherwin-Williams or Brushed Technique) are specified, the center panels of the selected style may be constructed of Medium Density Fiberboard (MDF). MDF provides a smoother finish when painted, and is more resistant to warping, expansion, and contraction.

Door Styles

Daxton Collection

Inset Door Styles*

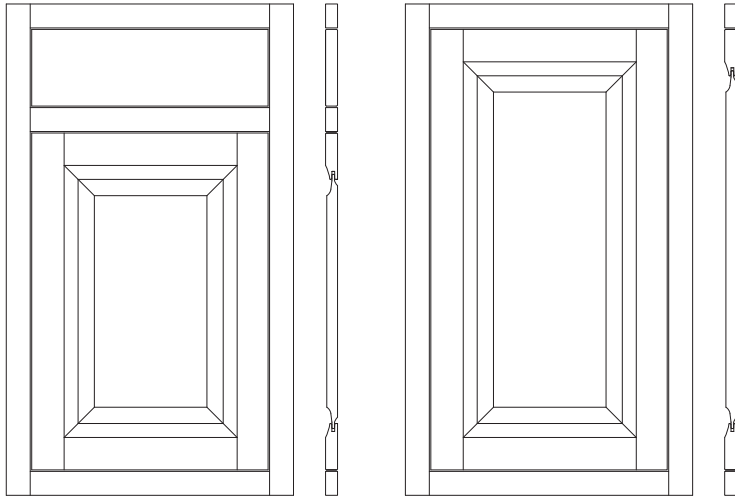

Square Base Cabinet

Square Wall Cabinet

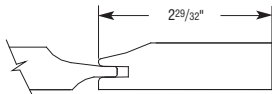

Door Rail/Center Panel Detail

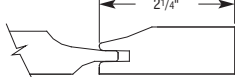

Option: DFR5PCINS Drawer Side Rail/Center Panel Detail

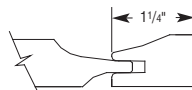

Option: DFR5PCINS Drawer Top/Bottom Rail/Center Panel Detail

Wood Species

Alder	2+15%
Cherry	4+15%
Maple	2+15%
Quartersawn Oak	4+15%
Rustic Alder	2+15%
Walnut	6+15%

Price Column

Outside Profile Selections

No. 12

Special Notes

- Solid slab drawer front
- Solid double raised center panel door

Design Notes

- Mullion and Prairie Mullion doors not available
- Finial Hinges (IFAB, IFBN, IFMB, IFORB) available on Profile #12 only. See page G•12 for details.
- Drawer Front Raised 5-piece Inset (DFR5PCINS) available. Some exceptions may apply. See page G•11 for details.

Beaded Inset Door Styles*

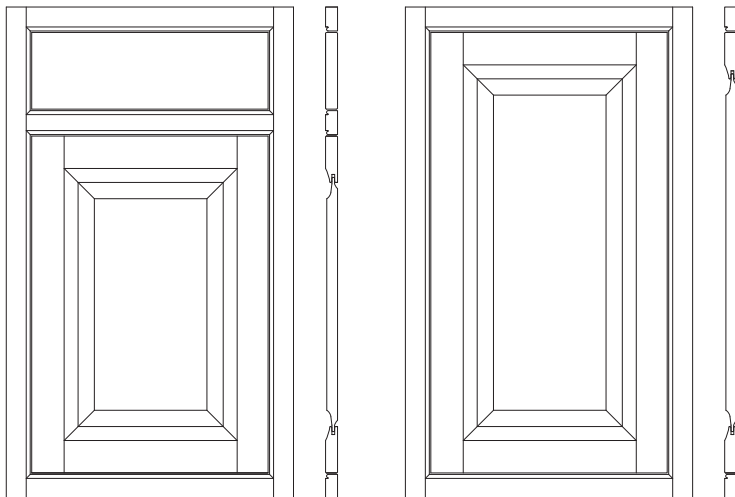

Square Base Cabinet

Square Wall Cabinet

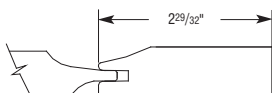

Door Rail/Center Panel Detail

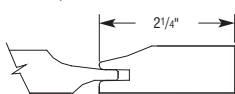

Option: DFR5PCINS Drawer Side Rail/Center Panel Detail

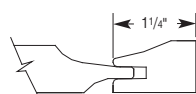

Option: DFR5PCINS Drawer Top/Bottom Rail/Center Panel Detail

Wood Species

Alder	2+15%
Cherry	4+15%
Maple	2+15%
Quartersawn Oak	4+15%
Rustic Alder	2+15%
Walnut	6+15%

Price Column

Outside Profile Selections

No. 12

Special Notes

- Solid slab drawer front
- Solid double raised center panel door

Design Notes

- Mullion and Prairie Mullion doors not available
- Finial Hinges (IFAB, IFBN, IFMB, IFORB) available on Profile #12 only. See page G•12 for details.
- Drawer Front Raised 5-piece Inset (DFR5PCINS) available. Some exceptions may apply. See page G•11 for details.

*When Maple painted finishes (Paints, Sherwin-Williams or Brushed Technique) are specified, the center panels of the selected style may be constructed of Medium Density Fiberboard (MDF). MDF provides a smoother finish when painted, and is more resistant to warping, expansion, and contraction.

Gunther Collection

Inset Door Styles*

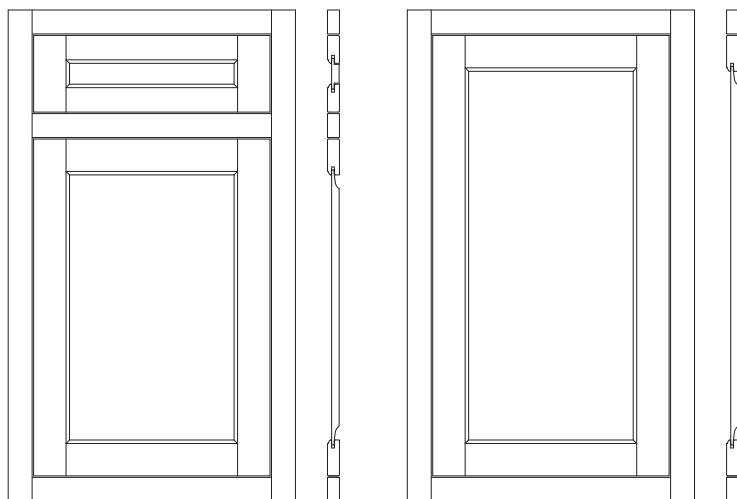

Square Base Cabinet

Square Wall Cabinet

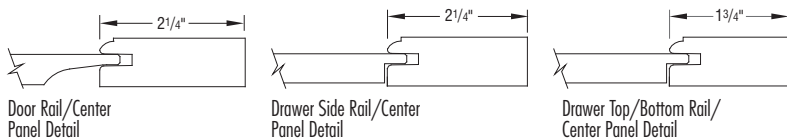

Door Rail/Center Panel Detail

Drawer Side Rail/Center Panel Detail

Drawer Top/Bottom Rail/Center Panel Detail

Wood Species

Alder	1+15%
Cherry	3+15%
Maple	1+15%
Quartersawn Oak	3+15%
Rustic Alder	1+15%
Walnut	5+15%

Price Column

Outside Profile Selections*



*Profile No. 12 shown

Special Notes

- 5-piece flat center panel drawer front
- Drawer fronts smaller than 4 13/16" high will have slab front
- 5-piece solid reverse raised panel door
- 5-piece drawer front will utilize a 1 3/4" wide top and bottom rail

Design Notes

- Solid slab drawer front (DFSLB) available. See page G•11.
- Solid slab drawer front top (DFSLBT) available. See page G•12.
- Finial Hinges (IFAB, IFBN, IFMB, IFORB) available on Profile #12 only. See page G•12 for details.

Beaded Inset Door Styles*

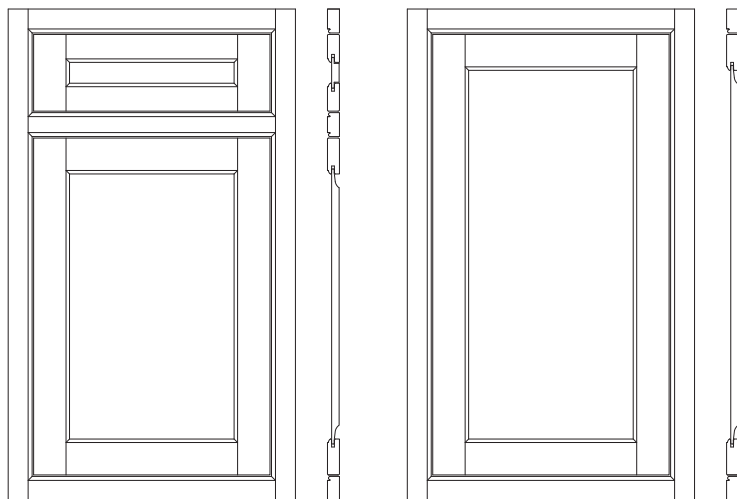

Square Base Cabinet

Square Wall Cabinet

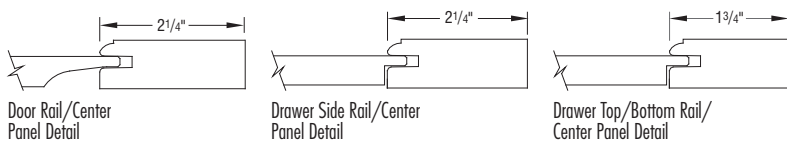

Door Rail/Center Panel Detail

Drawer Side Rail/Center Panel Detail

Drawer Top/Bottom Rail/Center Panel Detail

Wood Species

Alder	1+15%
Cherry	3+15%
Maple	1+15%
Quartersawn Oak	3+15%
Rustic Alder	1+15%
Walnut	5+15%

Price Column

Outside Profile Selections*



*Profile No. 12 shown

Special Notes

- 5-piece flat center panel drawer front
- Drawer fronts smaller than 4 13/16" high will have slab front
- 5-piece solid reverse raised panel door
- 5-piece drawer front will utilize a 1 3/4" wide top and bottom rail

Design Notes

- Solid slab drawer front (DFSLB) available. See page G•11.
- Solid slab drawer front top (DFSLBT) available. See page G•12.
- Finial Hinges (IFAB, IFBN, IFMB, IFORB) available on Profile #12 only. See page G•12 for details.

*When Maple painted finishes (Paints, Sherwin-Williams or Brushed Technique) are specified, the center panels of the selected style may be constructed of Medium Density Fiberboard (MDF). MDF provides a smoother finish when painted, and is more resistant to warping, expansion, and contraction.

Door Styles

Karis Collection

Inset Door Styles*

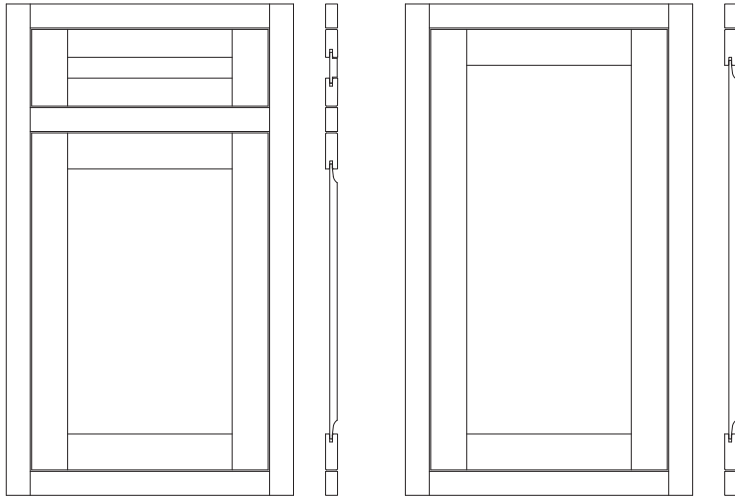

Square Base Cabinet

Square Wall Cabinet

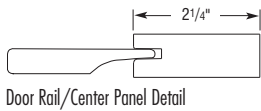

Door Rail/Center Panel Detail

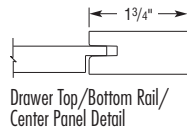

Drawer Top/Bottom Rail/Center Panel Detail

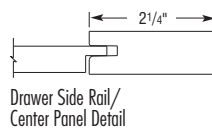

Drawer Side Rail/Center Panel Detail

Wood Species

Alder	1+15%
Cherry	3+15%
Maple	1+15%
Quartersawn Oak	3+15%
Rustic Alder	1+15%
Walnut	5+15%

Price Column

Outside Profile Selections*



*Profile No. 12 shown

Special Notes

- Drawer fronts smaller than 4 13/16" high will have slab front
- 5-piece flat center panel drawer front
- Solid reverse raised panel door

Design Notes

- Solid slab drawer front (DFSLB) available. See page G•11.
- Solid slab drawer front top (DFSLBT) available. See page G•11.
- Finial Hinges (IFAB, IFBN, IFMB, IFORB) available on Profile #12 only. See page G•12 for details.

Beaded Inset Door Styles*

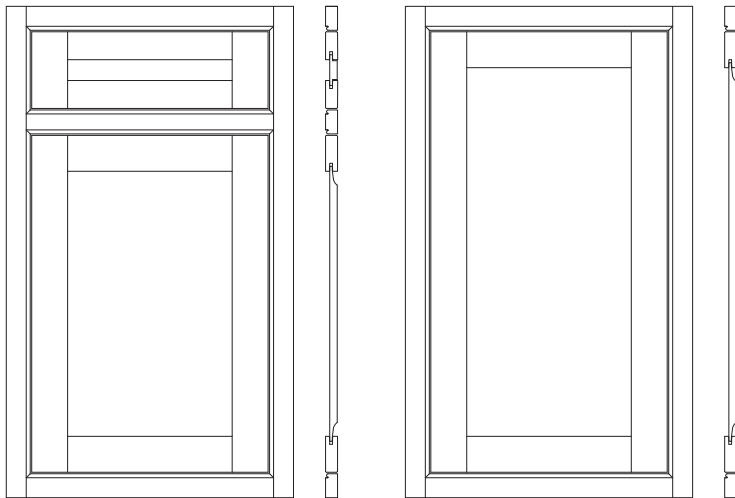

Square Base Cabinet

Square Wall Cabinet

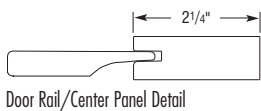

Door Rail/Center Panel Detail

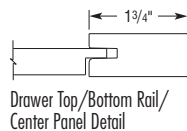

Drawer Top/Bottom Rail/Center Panel Detail

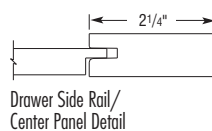

Drawer Side Rail/Center Panel Detail

Wood Species

Alder	1+15%
Cherry	3+15%
Maple	1+15%
Quartersawn Oak	3+15%
Rustic Alder	1+15%
Walnut	5+15%

Price Column

Outside Profile Selections*



*Profile No. 12 shown

Special Notes

- Drawer fronts smaller than 4 13/16" high will have slab front
- 5-piece flat center panel drawer front
- Solid reverse raised panel door

Design Notes

- Solid slab drawer front (DFSLB) available. See page G•11.
- Solid slab drawer front top (DFSLBT) available. See page G•11.
- Finial Hinges (IFAB, IFBN, IFMB, IFORB) available on Profile #12 only. See page G•12 for details.

*When Maple painted finishes (Paints, Sherwin-Williams or Brushed Technique) are specified, the center panels of the selected style may be constructed of Medium Density Fiberboard (MDF). MDF provides a smoother finish when painted, and is more resistant to warping, expansion, and contraction.

Langley Collection

Inset Door Styles*

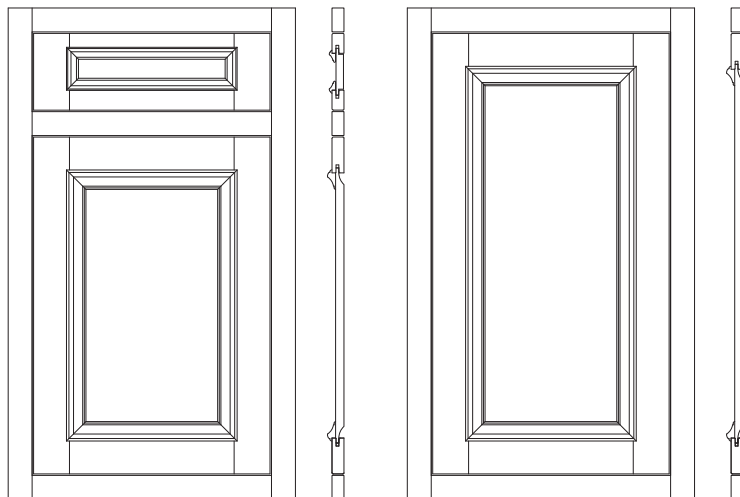

Square Base Cabinet

Square Wall Cabinet

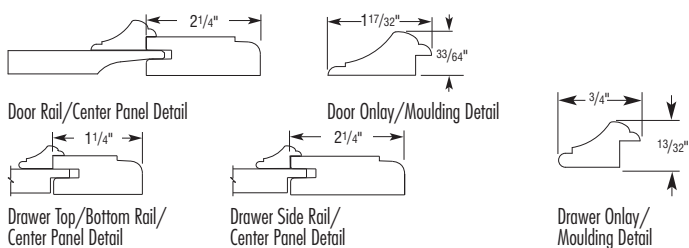

Door Rail/Center Panel Detail

Door Onlay/Moulding Detail

Drawer Top/Bottom Rail/Center Panel Detail

Drawer Side Rail/Center Panel Detail

Drawer Onlay/Moulding Detail

Wood Species

Alder	5+15%
Cherry	6+15%
Maple	5+15%
Quartersawn Oak	6+15%
Rustic Alder	5+15%
Walnut	7+15%

Price Column

Outside Profile Selections*



*Profile No. 12 shown

Special Notes

- Bold onlay moulding applied to door; larger than drawer
- 9-piece flat center panel drawer front with onlay moulding
- 9-piece solid reverse raised panel door
- Drawer fronts smaller than 4 13/16" high will have slab front

Design Notes

- Solid slab drawer front (DFSLB) available. See page G•11.
- Solid slab drawer front top (DFSLBT) available. See page G•12.
- Mullion doors and Prairie Mullion doors not available
- Finial Hinges (IFAB, IFBN, IFMB, IFORB) available on Profile #12 only. See page G•12 for details.

Beaded Inset Door Styles*

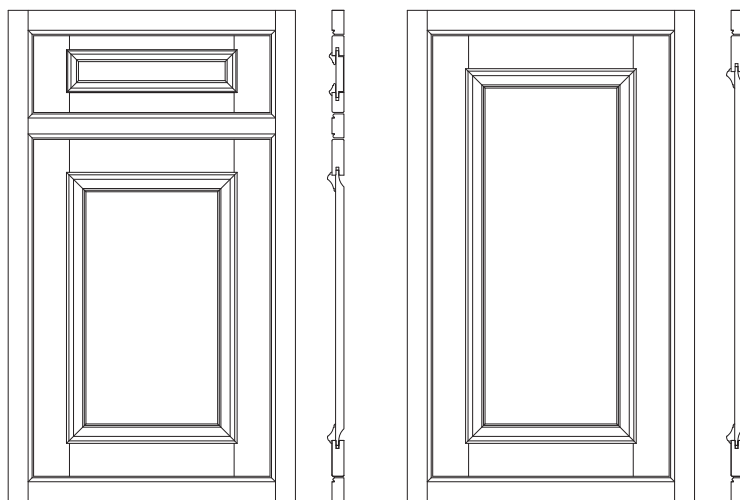

Square Base Cabinet

Square Wall Cabinet

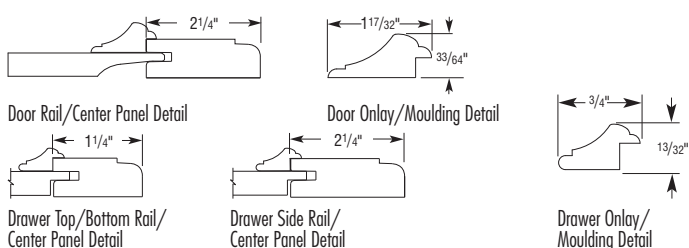

Door Rail/Center Panel Detail

Door Onlay/Moulding Detail

Drawer Top/Bottom Rail/Center Panel Detail

Drawer Side Rail/Center Panel Detail

Drawer Onlay/Moulding Detail

Wood Species

Alder	5+15%
Cherry	6+15%
Maple	5+15%
Quartersawn Oak	6+15%
Rustic Alder	5+15%
Walnut	7+15%

Price Column

Outside Profile Selections*



*Profile No. 12 shown

Special Notes

- Bold onlay moulding applied to door; larger than drawer
- 9-piece flat center panel drawer front with onlay moulding
- 9-piece solid reverse raised panel door
- Drawer fronts smaller than 4 13/16" high will have slab front

Design Notes

- Solid slab drawer front (DFSLB) available. See page G•11.
- Solid slab drawer front top (DFSLBT) available. See page G•12.
- Mullion doors and Prairie Mullion doors not available
- Finial Hinges (IFAB, IFBN, IFMB, IFORB) available on Profile #12 only. See page G•12 for details.

*When Maple painted finishes (Paints, Sherwin-Williams or Brushed Technique) are specified, the center panels of the selected style may be constructed of Medium Density Fiberboard (MDF). MDF provides a smoother finish when painted, and is more resistant to warping, expansion, and contraction.

Door Styles

Montgomery Collection

NEW Inset Door Styles*

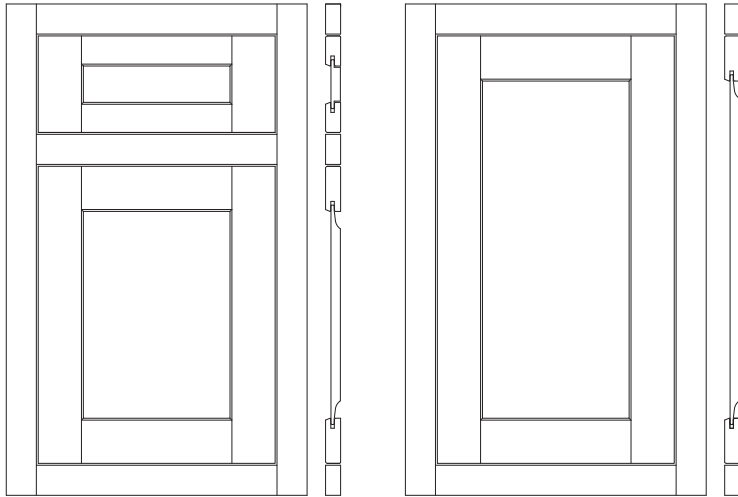

Square Base Cabinet

Square Wall Cabinet

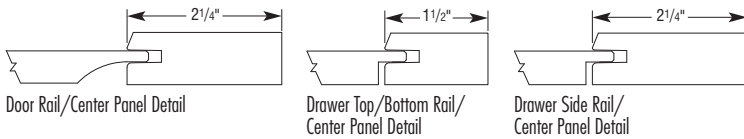

Door Rail/Center Panel Detail

Drawer Top/Bottom Rail/Center Panel Detail

Drawer Side Rail/Center Panel Detail

Wood Species

Alder	1+15%
Cherry	3+15%
Maple	1+15%
Quartersawn Oak	3+15%
Rustic Alder	1+15%
Walnut	5+15%

Price Column

Outside Profile Selections*

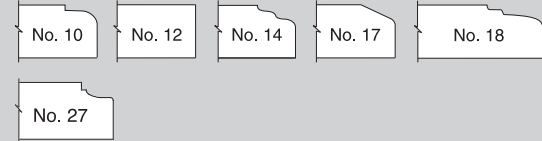

*Profile No. 12 shown

Special Notes

- 5-piece flat center panel drawer front
- Drawer fronts smaller than 5 3/4" high will have slab front
- Solid reverse raised panel door

Design Notes

- Solid slab drawer front (DFSLB) available. See page G•11.
- Solid slab drawer front top (DFSLBT) available. See page G•12.
- Finial Hinges (IFAB, IFBN, IFMB, IFORB) available on Profile #12 only. See page G•12 for details.

NEW Beaded Inset Door Styles*

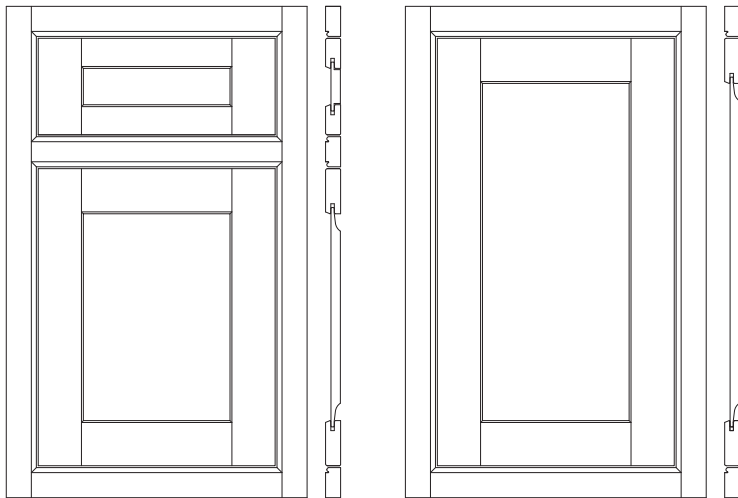

Square Base Cabinet

Square Wall Cabinet

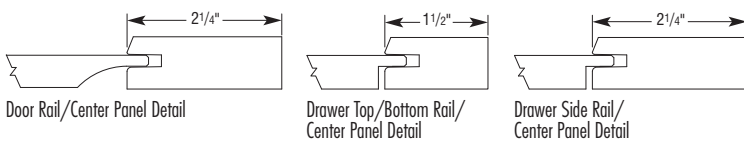

Door Rail/Center Panel Detail

Drawer Top/Bottom Rail/Center Panel Detail

Drawer Side Rail/Center Panel Detail

Wood Species

Alder	1+15%
Cherry	3+15%
Maple	1+15%
Quartersawn Oak	3+15%
Rustic Alder	1+15%
Walnut	5+15%

Price Column

Outside Profile Selections*

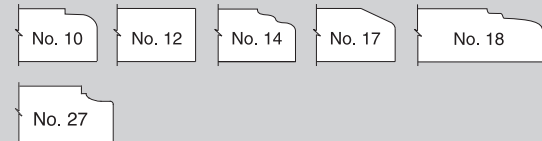

*Profile No. 12 shown

Special Notes

- 5-piece flat center panel drawer front
- Drawer fronts smaller than 5 3/4" high will have slab front
- Solid reverse raised panel door

Design Notes

- Solid slab drawer front (DFSLB) available. See page G•11.
- Solid slab drawer front top (DFSLBT) available. See page G•12.
- Finial Hinges (IFAB, IFBN, IFMB, IFORB) available on Profile #12 only. See page G•12 for details.

*When Maple painted finishes (Paints, Sherwin-Williams or Brushed Technique) are specified, the center panels of the selected style may be constructed of Medium Density Fiberboard (MDF). MDF provides a smoother finish when painted, and is more resistant to warping, expansion, and contraction.

Shona Collection

Inset Door Styles*

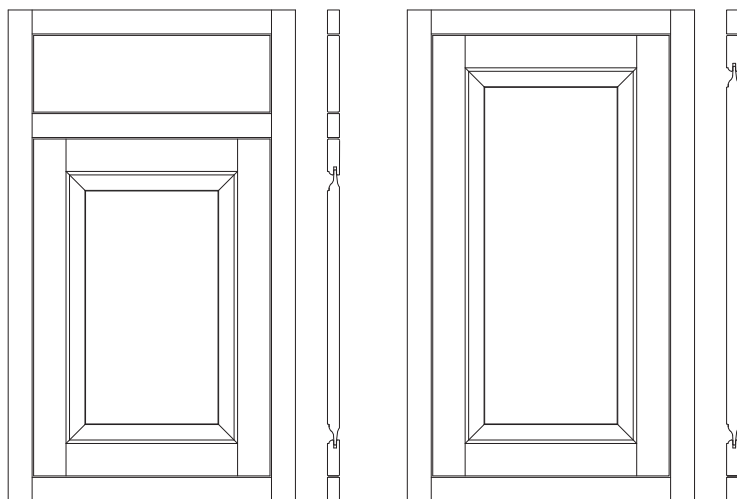

Square Base Cabinet

Square Wall Cabinet

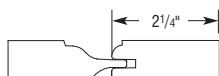

Door Side Rail/Center Panel Detail

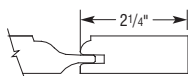

Option: DFR5PCINS Drawer Side Rail/Center Panel Detail

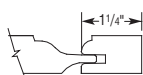

Option: DFR5PCINS Drawer Top/Bottom Rail/Center Panel Detail

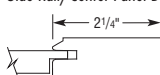

Option: DFF5PCINS Drawer Rail/Center Panel Detail

Wood Species

Alder	1+15%
Cherry	3+15%
Maple	1+15%
Quartersawn Oak	3+15%
Rustic Alder	1+15%
Walnut	5+15%

Price Column

Outside Profile Selections*



*Profile No. 12 shown

Special Notes

- Solid slab drawer front
- 5-piece solid double raised panel door

Design Notes

- Finial Hinges (IFAB, IFBN, IFMB, IFORB) available on Profile #12 only. See page G•12 for details.
- Drawer Front Flat 5-piece Inset (DFF5PCINS) available. Some exceptions may apply. See page G•10 for details.
- Drawer Front Raised 5-piece Inset (DFR5PCINS) available. Some exceptions may apply. See page G•11 for details.

Beaded Inset Door Styles*

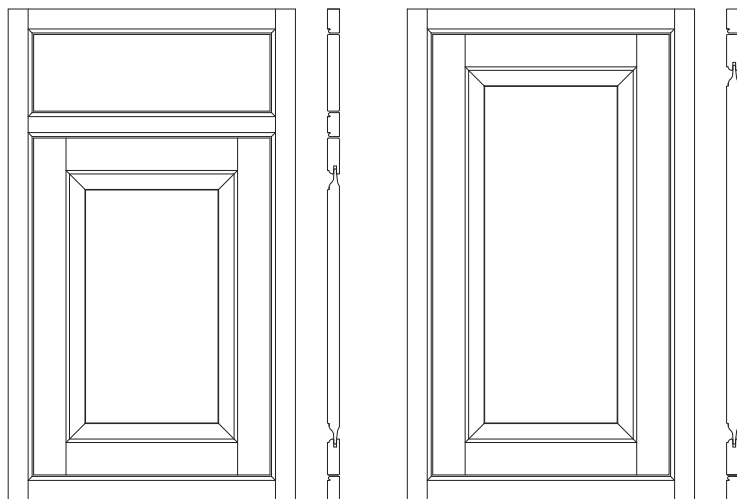

Square Base Cabinet

Square Wall Cabinet



Door Side Rail/Center Panel Detail

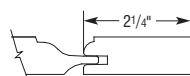

Option: DFR5PCINS Drawer Side Rail/Center Panel Detail

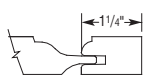

Option: DFR5PCINS Drawer Top/Bottom Rail/Center Panel Detail



Option: DFF5PCINS Drawer Rail/Center Panel Detail

Wood Species

Alder	1+15%
Cherry	3+15%
Maple	1+15%
Quartersawn Oak	3+15%
Rustic Alder	1+15%
Walnut	5+15%

Price Column

Outside Profile Selections*



*Profile No. 12 shown

Special Notes

- Solid slab drawer front
- 5-piece solid double raised panel door

Design Notes

- Finial Hinges (IFAB, IFBN, IFMB, IFORB) available on Profile #12 only. See page G•12 for details.
- Drawer Front Flat 5-piece Inset (DFF5PCINS) available. Some exceptions may apply. See page G•10 for details.
- Drawer Front Raised 5-piece Inset (DFR5PCINS) available. Some exceptions may apply. See page G•11 for details.

*When Maple painted finishes (Paints, Sherwin-Williams or Brushed Technique) are specified, the center panels of the selected style may be constructed of Medium Density Fiberboard (MDF). MDF provides a smoother finish when painted, and is more resistant to warping, expansion, and contraction.

Door Styles

Tackett Collection

Inset Door Styles*

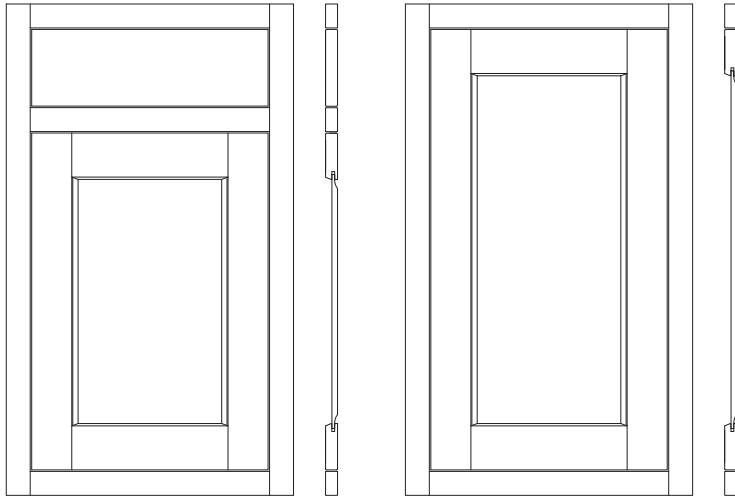

Square Base Cabinet

Square Wall Cabinet

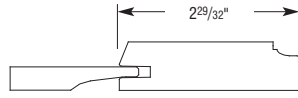
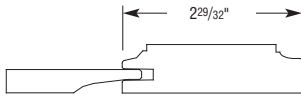

Door Side Rail/Center Panel Detail

Door Top/Bottom Rail/Center Panel Detail

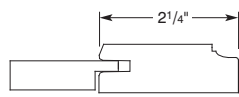
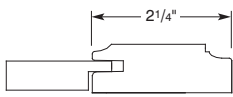

Option: DFF5PCINS Drawer Side Rail/Center Panel Detail

Option: DFF5PCINS Drawer Top/Bottom Rail/Center Panel Detail

Wood Species

Alder	2+15%
Cherry	4+15%
Maple	2+15%
Quartersawn Oak	4+15%
Rustic Alder	2+15%
Walnut	6+15%

Price Column

Outside Profile Selections*



*Profile No. 12 shown

Special Notes

- Solid slab drawer front
- 5-piece solid reverse raised panel door

Design Notes

- Mullion and Prairie Mullion doors not available
- Finial Hinges (IFAB, IFBN, IFMB, IFORB) available on Profile #12 only. See page G•12 for details.
- Drawer Front Flat 5-piece Inset (DFF5PCINS) available. Some exceptions may apply. See page G•10 for details.

Beaded Inset Door Styles*

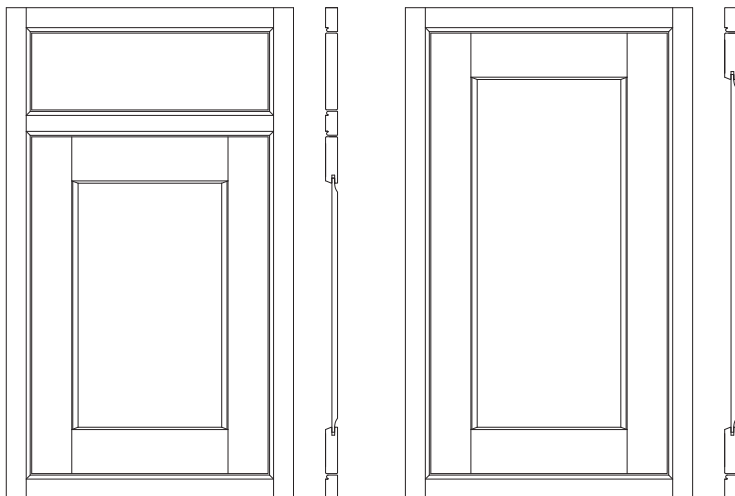

Square Base Cabinet

Square Wall Cabinet

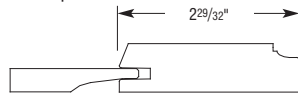
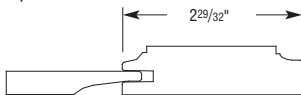

Door Side Rail/Center Panel Detail

Door Top/Bottom Rail/Center Panel Detail

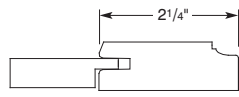
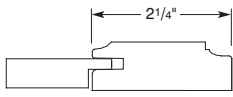

Option: DFF5PCINS Drawer Side Rail/Center Panel Detail

Option: DFF5PCINS Drawer Top/Bottom Rail/Center Panel Detail

Wood Species

Alder	2+15%
Cherry	4+15%
Maple	2+15%
Quartersawn Oak	4+15%
Rustic Alder	2+15%
Walnut	6+15%

Price Column

Outside Profile Selections*



*Profile No. 12 shown

Special Notes

- Solid slab drawer front
- 5-piece solid reverse raised panel door

Design Notes

- Mullion and Prairie Mullion doors not available
- Finial Hinges (IFAB, IFBN, IFMB, IFORB) available on Profile #12 only. See page G•12 for details.
- Drawer Front Flat 5-piece Inset (DFF5PCINS) available. Some exceptions may apply. See page G•10 for details.

*When Maple painted finishes (Paints, Sherwin-Williams or Brushed Technique) are specified, the center panels of the selected style may be constructed of Medium Density Fiberboard (MDF). MDF provides a smoother finish when painted, and is more resistant to warping, expansion, and contraction.

Trystan Collection

 Inset Door Styles*

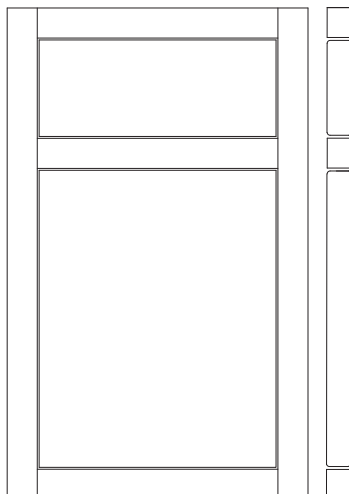

Square Base Cabinet

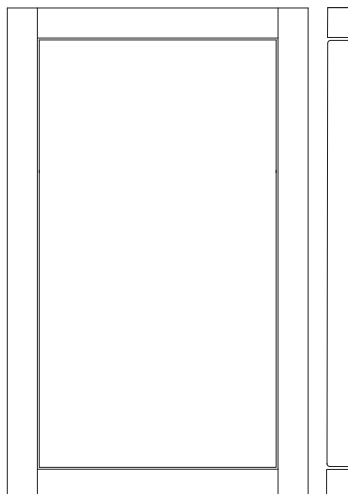

Square Wall Cabinet

Wood Species

MDF

Price Column

1+15%

Outside Profile Selections

No. 12

Special Notes

- Slab drawer front
- Slab door
- Not available with Hewn, Extra Hewn, Timeworn, or Extra Timeworn
- MDF door and drawer front components will be MDF. Face frame and box parts utilize maple paint material, and trim and panels utilize maple species.

Design Notes

- Mullion doors and Prairie Mullion doors not available.
- Finial Hinges (IFAB, IFBN, IFMB, IFORB) available on Profile #12 only. See page G•12 for details.

 Beaded Inset Door Styles*

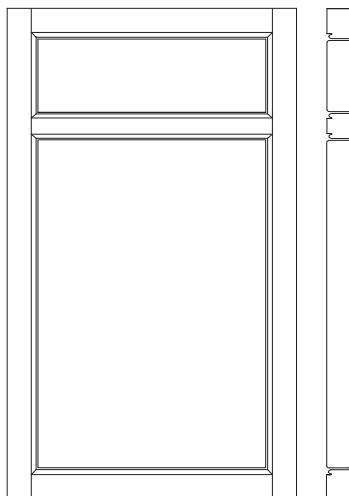

Square Base Cabinet

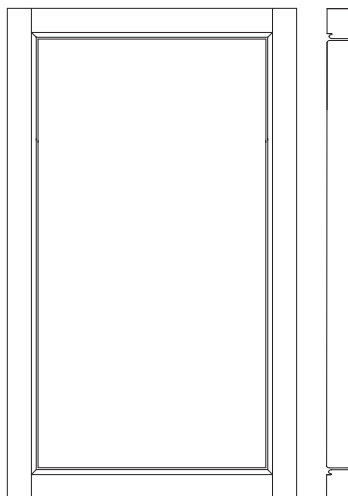

Square Wall Cabinet

Wood Species

MDF

Price Column

1+15%

Outside Profile Selections

No. 12

Special Notes

- Slab drawer front
- Slab door
- Not available with Hewn, Extra Hewn, Timeworn, or Extra Timeworn
- MDF door and drawer front components will be MDF. Face frame and box parts utilize maple paint material, and trim and panels utilize maple species.

Design Notes

- Mullion doors and Prairie Mullion doors not available.
- Finial Hinges (IFAB, IFBN, IFMB, IFORB) available on Profile #12 only. See page G•12 for details.

*When Maple painted finishes (Paints, Sherwin-Williams or Brushed Technique) are specified, the center panels of the selected style may be constructed of Medium Density Fiberboard (MDF). MDF provides a smoother finish when painted, and is more resistant to warping, expansion, and contraction.

Door Styles

Vesta Collection

Inset Door Styles*

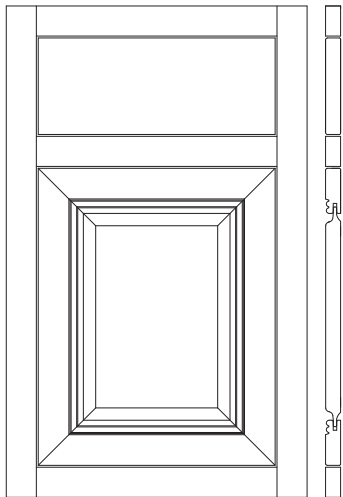

Square Base Cabinet

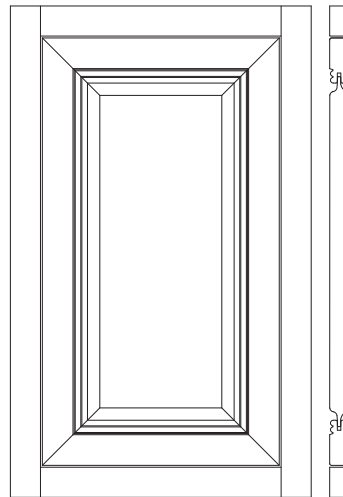

Square Wall Cabinet

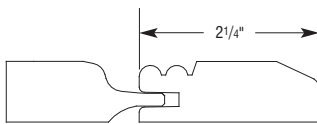

Door Rail/Center Panel Detail

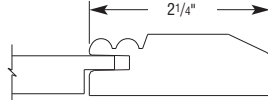

Option: DFF5PCINS Drawer Rail/Center Panel Detail

Wood Species

Alder	2+15%
Cherry	4+15%
Maple	2+15%
Quartersawn Oak	4+15%
Rustic Alder	2+15%
Walnut	6+15%

Price Column

Outside Profile Selections*

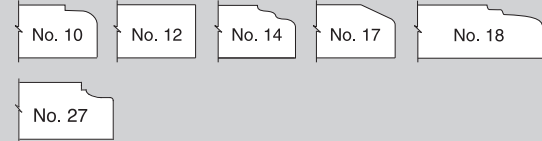

*Profile No. 12 shown

Special Notes

- Solid slab drawer front
- Solid double raised center panel door

Design Notes

- Mullion and Prairie Mullion doors not available.
- Finial Hinges (IFAB, IFBN, IFMB, IFORB) available on Profile #12 only. See page G•12 for details.
- Drawer Front Flat 5-piece Inset (DFF5PCINS) available. Some exceptions may apply. See page G•10 for details.

Beaded Inset Door Styles*

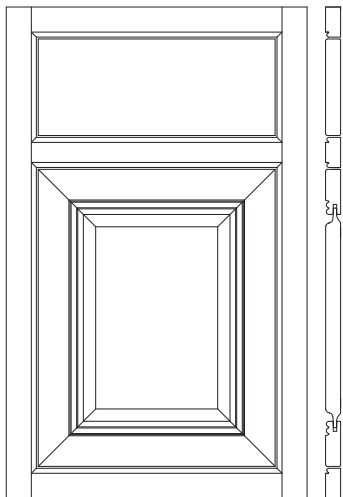

Square Base Cabinet

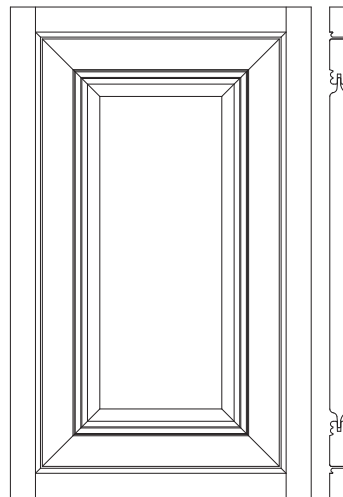

Square Wall Cabinet

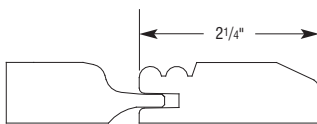

Door Rail/Center Panel Detail

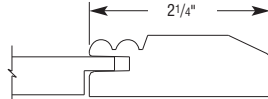

Option: DFF5PCINS Drawer Rail/Center Panel Detail

Wood Species

Alder	2+15%
Cherry	4+15%
Maple	2+15%
Quartersawn Oak	4+15%
Rustic Alder	2+15%
Walnut	6+15%

Price Column

Outside Profile Selections*

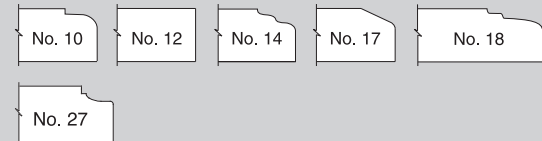

*Profile No. 12 shown

Special Notes

- Solid slab drawer front
- Solid double raised center panel door

Design Notes

- Mullion and Prairie Mullion doors not available.
- Finial Hinges (IFAB, IFBN, IFMB, IFORB) available on Profile #12 only. See page G•12 for details.
- Drawer Front Flat 5-piece Inset (DFF5PCINS) available. Some exceptions may apply. See page G•10 for details.

*When Maple painted finishes (Paints, Sherwin-Williams or Brushed Technique) are specified, the center panels of the selected style may be constructed of Medium Density Fiberboard (MDF). MDF provides a smoother finish when painted, and is more resistant to warping, expansion, and contraction.

Diamond Edge's Door Applications

Diamond Edge proudly offers multiple finishes and techniques to provide limitless looks for you and your customers.

Finishes

- Stains
- Specialties
- Paints
- Sherwin-Williams® Color Palette
- Brushed Finish
- Ceruse Finish

Sheens

- Standard Sheen
- Matte Sheen Option

Glazes

- Penned Glazes
- Flooded Glazes

Techniques

- Hewn
- Extra Hewn
- Timeworn
- Extra Timeworn

Finishes

Stains

Stained finishes highlight the inherent qualities of genuine wood to create a truly beautiful product. Shadings of white, red, black and even green may be visible. Mineral streaks may also add to the distinctive appearance, reflecting the tree "life history" as it absorbed minerals differently in one region or another. Grain and apparent texture may range from even and consistent to varied and dramatic. The natural variations will be present throughout Diamond Edge cabinetry, resulting in unique character marking on adjacent cabinets, on pairs of doors, and even within the same panel. These variations will also appear on edges of hardwood doors where solid lumber cores are exposed in certain Diamond Edge styles (those featuring flush doors and drawer fronts). These unique characteristics of Natural finishes point out that each piece of wood is different; varied effect of finished cabinetry in a complete installation may be different from that represented by a smaller display or finish sample. The variations are broad, and that is where the beauty of wood lies. A stained finish uses both the toner and the wipe stain to achieve the final color. The toner is applied to the door and allowed to dry. A wipe stain is hand-applied to achieve the final color. All standard finishes will exhibit some degree of Natural characteristics.

Specialty Finishes

Alpaca

Developed to introduce a neutral color that works well with a wide variety of complements. The muted green tones were pulled into this finish to allow it to work as an accent color or a stand alone finish. The base color for Alpaca is an off white or creamy colored paint. This finish has a green glaze applied to the total product as a "Flooded Glaze" which allows the glaze to have an effect on the overall color. Some faint rag marks on the surface may be left to simulate the look of 'brush strokes', but no heavy streaks.

Balsamic and Cordial Ombres

A new look to an old style; Diamond Edge is refreshing the classics by providing the Ombre collection, a dual toned sunburst effect of a golden amber or shadowed ruby, eclipsed by a dark chocolate hue. This finish seamlessly blends the characteristics of the lighter stains with a dark, semi-transparent toner. This is accomplished by a skilled spraying technique of two different toners with a wiped stain to help blend the two colors into one unique finish. There may be a dark chocolate glazed effect left in some profiles and especially highlighted within the lighter tones of this finish. This will show grain patterns, as well as pick up the lighter and darker tones within the wood itself. The exact placement of the fade transition will vary from one door style to another. The Ombre effect is only applicable on doors, drawer fronts, overlays, authentic ends, inset panel ends, integral ends, and select accessories.

Beachglass

Developed as a naturally worn accent color, complementary to the Diamond Edge palette, the base color for Beachglass is a turquoise toner with the Toasted Almond glaze applied as a "Flooded Glaze". The glaze will be completely flooded on the product and wiped to leave hang up in profiles as well as allowing rag marks along the surface. This finish is not intended to be cleaned up with mineral, but rather, allowed to look very dirty so the glaze has an effect on the overall color. A brown "spattering" material is also applied to the overall product in varying sizes. This technique should allow for some clustering as well as a few, small blank areas. Inconsistencies should be expected.

Black Canyon

This finish has a black surface finish with a brownish red undercoat. As the product is chemically distressed to achieve its weathered or well worn appearance, the red undercoat will be seen beneath the top Black toner to accentuate the two colors. The complement of the red and black expands the choices within the color palette and allows for a bold risk on a minimal scale. Canyon effect only applicable on doors, drawer fronts, overlays, authentic ends, inset panel ends, integral ends, and select accessories.

Cigar Box

Refined finish. This hue incorporates deep rich reds, oranges and browns with a black glaze that shadows the profiles and helps define the grain and enhance the natural beauty of the wood tones. This multi-tonal finish has added definition with the introduction of speckling to the overall surface of the doors, face frames, accessories and panels. This is a transparent stain with all the depth of fine aged whiskey.

Driftwood

A whisper of cloudy white translucence plays with natural wood tones in Diamond Edge's Driftwood finish. This color was developed to introduce a neutral color that works well with a wide variety of complements. The black tones were pulled into this finish to allow it to work as an accent color or a stand alone finish, and the base color is an off white or creamy colored transparent toner. Minimal grain and minerals will be visible under the finish, which will allow wood characteristics to have play in the overall look. This finish has a black "flooded" glaze applied to the total product which allows the glaze to have an effect on the overall color creating a veiling effect. Some faint rag marks on the surface may be left to enhance the character of this finish.

Dunes

The beautiful, matte, beach-washed look of Dunes is achieved by overlaying a soft white toner with a warm gray contrasting stain. Though the stain is wiped away, it collects in the profiles of the door style, and depending on the graininess of the wood species selected, catches in the grain on the door surface as well. This semi-translucent finish provides depth and dimension, making it an interesting addition or alternative to paint.

Poppyseed

This finish allows Diamond Edge to incorporate the natural beauty of raw wood with the realistic hues of stone. This is a semi-transparent slate gray toner that is accented with a dark brown glaze which provides the overall look of a historic stone floor. The finish will show grain patterns, as well as pick up the light and dark tones in the wood color itself. By integrating stone and wood, Diamond Edge has provided a beautiful complement to the existing finish palette.

Thicket

The layering of dark, cool, gray-brown stain over soft white toner creates an intriguing veil of finish causing Thicket to ride the line between dark and light. Though the stain is wiped away, it collects in the profiles of the door style, and depending on the graininess of the wood species selected, catches in the grain on the door surface as well. This semi-translucent finish showcases wood's natural beauty which allows it to pair handsomely with other stains and paints.

Finishes

Worn Beachglass

Developed as a naturally worn accent color, complementary to the Diamond Edge palette, the base color for Worn Beachglass is a turquoise toner with the Toasted Almond glaze applied as a “Flooded Glaze”. The glaze will be completely flooded on the product and wiped to leave hang up in profiles as well as allowing rag marks along the surface. This finish is not intended to be cleaned up with mineral, but rather, allowed to look very dirty so the glaze has an effect on the overall color. A sand-through process is involved with a chemical wipe down of the toner to create bare wood areas that fade out to simulate natural wear. Most if not all corners should be hit in varying degrees, as well as “hit and miss” inside and outside profiles. A brown “spattering” material is also applied to the overall product in varying sizes. This technique should allow for some clustering as well as a few, small blank areas. Inconsistencies should be expected.

Worn Black

This black finish combines the aged surface of a higher degree of distressing with the appealing imperfections of our Timeworn technique. Worn Black utilizes the same chemical distressing process of Black Canyon but will reveal the underlying wood color only.

Paints

An interactive collection that is hand-picked and in step with today’s most popular fashions and emerging trends, Diamond Edge has a palette of 30 custom hues. This colorful collection is readily available without a color sample request, nor the requirement of a signed door, allowing for order placement and fulfillment within current lead times. You’ll find a wealth of popular neutral tones from light to dark, as well as a chart-topping offering of gray pigmentations. Pops of trend-centric colors are also included, allowing the design statement your customer craves. While some colors may remain constant for several selling cycles, you’ll find this collection to be carefully curated with colors that are relevant to homes today.

A painted finish is a full color hiding finish. When using a painted finish on a tight grain wood surface, the surface will be smooth and no wood grain should be seen.

Available on Maple, MDF and Quartersawn Oak species with Amaretto Crème, Grey Stone, Meringue, Nougat, Smoked Caviar, and Toasted Almond panned glazes available on Maple only. These panned glaze options are not available on the Trystan door style. Black not available with Smoked Caviar panned glaze.

When Maple painted finishes (Paints, Sherwin-Williams or Brushed Technique) are specified, the center panels of the selected style may be constructed of Medium Density Fiberboard (MDF). MDF provides a smoother finish when painted, and is more resistant to warping, expansion, and contraction.

Please note: Sherwin-Williams paints with the same color name as your cabinetry color name will not be an exact match. When seeking to match your Diamond Edge cabinetry paint color, have a cabinet door color-matched at a nearby Sherwin-Williams® paint store to reduce the likelihood and/or significance of color variation. Exact color matching is not guaranteed, and MasterBrand Cabinets will not replace cabinetry or refund money due to color discrepancies.

Sherwin-Williams® Color Palette

Diamond Edge has partnered with Sherwin-Williams to bring thousands of paint color options to our customers in search of the perfect option to suit their vision. The Sherwin-Williams Color Palette offers paint colors found at Sherwin-Williams Paint stores or online at www.sherwin-williams.com. Valid paint options begin with the code SW_ _ _ _.

This broad palette is available on Maple, MDF and Quartersawn Oak species, and can be paired with Amaretto Crème, Grey Stone, Meringue, Nougat, Smoked Caviar, and Toasted Almond panned glazes on Maple. (Panned glaze options are not available on the Trystan door style. Smoked Caviar panned glaze is not available on Black paint.) An additional 2 week lead time is required for all cabinet orders featuring Sherwin-Williams paint colors.

Please note: Sherwin-Williams paints with the same paint color name as your cabinetry will not be an exact match. When seeking to match your Diamond Edge cabinetry paint color, have a cabinet door color-matched at a nearby Sherwin-Williams paint store to reduce the likelihood and/or significance of color variation. Exact color matching is not guaranteed, and MasterBrand Cabinets will not replace cabinetry or refund money due to color discrepancies.

When Maple painted finishes (Paints, Sherwin-Williams or Brushed Technique) are specified, the center panels of the selected style may be constructed of Medium Density Fiberboard (MDF). MDF provides a smoother finish when painted, and is more resistant to warping, expansion, and contraction.

One PAINTPEN will come with original order. PAINTPEN-ADD will allow up to 2 additional pens to be ordered with the original order only.

Code	Description	Price Per Pen
PAINTPEN	Paint Pen	Free with Original Order
PAINTPEN-ADD	Paint Pen Additional	\$71 per Additional Paint Pen

We highly recommend ordering a sample to see the true color as presented on wood. To order a sample you must:

1. Submit a “Sample Door Order Form”, found on www.mbc1touch.com. Please include the Sherwin-Williams finish number (SW_ _ _ _) along with the door style, species, and profile selection.
2. Upon receiving the “Sample Door Order Form”, a sample door in the style, species and profile requested will be produced. One half of the door will be sent to the customer for review and the other half will be retained by Diamond Edge to verify color match.

Code	Description
CCSMPL	Sherwin-Williams Color Sample

3. The customer will review and approve the door sample. Submit the cabinet order and include the following: “Sherwin-Williams Color Sample Waiver” form (received with the 1/2 CCSMPL from Diamond Edge), Purchase Order Number (PO#) and Finish Number.

To ensure understanding, we will require completion of the “Sherwin-Williams Color Sample Waiver” form when a sample is not desired (see page V•5).

Brushed Finish

This program allows for flexibility to choose any painted finish or Sherwin-Williams® Color Palette and combine with one of three choices: Brushed Lakeshore, Brushed Nightfall or Brushed Timber, to create a one of a kind look. Available on Maple and MDF species only. The techniques of Extra Hewn, Extra Timeworn, Hewn, or Timeworn are not available in combination with brushed finish.

When Maple painted finishes (Paints, Sherwin-Williams or Brushed Technique) are specified, the center panels of the selected style may be constructed of Medium Density Fiberboard (MDF). MDF provides a smoother finish when painted, and is more resistant to warping, expansion, and contraction.

1. A sample is **required** before purchasing any product in a brushed finish option. A "Sample Door Order Form", found on www.mbc1touch.com, must be submitted. Please include the door style and profile selection.
2. Upon receiving the "Sample Door Order Form", a sample door in the finish, style and profile requested will be produced, labeled, and reference the order number. One half of the door will be sent to the customer for approval and the other half will be retained by Diamond Edge. After 90 days, a new custom color sample (CCSMPL) is required.

Code	Description
CCSMPL	Brushed Sample

3. The customer will review and approve the door sample. A Brushed Finish Agreement Form is required (received with the 1/2 CCSMPL from Diamond Edge). Submit the cabinet order and include the following: "Brushed Finish Agreement" Form and Purchase Order Number (PO#).

Brushed Lakeshore

Brushed Lakeshore is a soft gray, toned color applied to the selected base color.

Brushed Nightfall

Brushed Nightfall is a rich, black toned color applied to the selected base color.

Brushed Timber

Brushed Timber is a lush brown toned color applied to the selected base color.

The hand-brushed application is designed to give depth and movement to the base color. Depending on the combination selected, the finished look can range from an aged, weathered appearance to a modern contemporary look. Brushed Lakeshore, Nightfall and Timber are only available on painted finishes on Maple and MDF.

Brushed Finish Application Details

	Front of Door	Back of Door	Face Frame	Ends	Fixed Door on End	Recessed/Raised Panel End	Interior of Open & Glass Door Cabinetry (if matching interior mod is specified)
Brushed Finish	YES	NO	YES	YES	YES	YES	YES

Direction of brush stroke with Brushed Finishes.

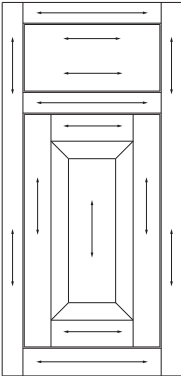

Ceruse Finish

Ceruse, also known as "limed", is a pigmented grain filler that adds contrast against the open pores of the grain of stained Quartersawn Oak wood species. This creates an effect evoking a bygone era of craftsmanship and style that has made a comeback today. Ceruse is available on Buckskin, Morel and Seal in two colorways.

Brindle

The contrasting qualities of white ceruse against stained finishes offer an aesthetic that reads vintage just as easily as modern styling.

Roan

Dark ceruse plays off of stained finishes, lending a moody vibe and a furniture feel that complements any style décor.

Sheens, Glazes and Techniques

Sheens

Diamond Edge products are enhanced with a predetermined furniture sheen level, complementing the natural beauty of the selected wood and finish combination.

Standard Sheen

Diamond Edge's standard sheen, non-pigmented top coat accentuates the beauty of a variety of finishes, adding a soft patina to selected wood/finish combinations as well as all painted products.

Matte Sheen Option

The Matte Sheen option is a low sheen, non-pigmented top coat available on all paints and stains except Ceruse finishes. The average degree of sheen is 5°.

Glazes

Diamond Edge has multiple door style selections that represent many of the trends and fashions found in today's kitchens and baths. Each door style will uniquely change the appearance of your kitchen. For example, a glaze product is not usually favored for door styles that have limited areas on the profile for glazes to hang up. Doors designed with greater detail will have a heavily shadowed appearance due to the increased amount of glaze hang up.

Flooded Glaze

All flooded glazes will have a rustic appearance. This finish technique involves flooding the wood component with the glaze material and then hand-wiping the excess material into and off of the component. The glaze material is not completely wiped from the corners of the door and it is left to accumulate in the corners and along the profiles of the component. The uniqueness of the materials and the process of hand-wiping will cause a variation from door to door and within the same component. Depending on the color of glaze applied, the mineral or natural wood characteristics of the door may become more accentuated.

Penned Glaze

After the product is finished, it is removed from the finish line and transferred to the panned operation. The panned glaze is hand-applied in areas of the door, drawer front, and select mouldings to highlight distinct profiles. Face frames, ends, matching interior, panels, and selected mouldings will not have panned glaze applied. The color on panned glaze is not dependent on the panned glaze to achieve the desired color, therefore the panned glaze is not applied or flooded on the entire part. The moulding and embellishment pieces that do not receive panned glaze do not have profiled areas for the panned glaze to be applied, and will match the base color of the doors.

Techniques

As with normal aging, the distressed areas can vary within individual doors and throughout the entire room. The effect can vary based on the door or drawer front profile and technique selected. Each combination of finish, species and door style will provide a unique look. The areas that are distressed may be enhanced with glazes or specialty finishes, while they may appear more muted with lighter colors, stains and finishes. It is recommended that a sample door and drawer front be ordered to illustrate these unique characteristics. Due to the organic and artistic nature of the hand application of these techniques, Diamond Edge is not responsible for variability on parts within and among orders that meet specifications.

Timeworn

This light distressing technique features random worm holes, tiny dents and light signs of wear to mimic the appearance of imperfections similar to those found on antiques. The technique will be applied to doors, drawer fronts, face frames, fillers, overlay fillers, valances, solid wood portions of wood tops, turnings, embellishments, integrated end panels, solid wood areas of wood hoods, and mouldings. Plywood cabinet box panels including ends, tops/bottoms, backs, shelves, and accessory panels will NOT get the application. Additional inclusions or exclusions may apply. Not available with the brushed finish technique.

Extra Timeworn

This more aggressive technique includes random rasped corners and edges, worm holes, mars, splits, gouges, small dings and dents for an authentically worn look. The technique will be applied to doors, drawer fronts, overlay fillers, valances, solid wood portions of wood tops, turnings, embellishments, integrated end panels, solid wood areas of wood hoods, and mouldings. Face frames and fillers will receive only Timeworn characteristics. Plywood cabinet box panels including ends, tops/bottoms, backs, shelves, and accessory panels will NOT get the application. Additional inclusions or exclusions may apply. Not available with the brushed finish technique.

Hewn

This subtle technique mimics finish wear that naturally develops over time, and features a continuous but light sand-through along the sharp profiles to highlight the distinctive details of each door and drawer front. Sand-through may vary in thickness around the perimeter of a single door and throughout the kitchen. The technique will be applied to doors, drawer fronts, overlays, mouldings, and embellishments where sharp profiles are applicable. Face frames, panels, straight fillers, and plywood will NOT get the application. Additional inclusions or exclusions may apply. Hewn is not available on Unfinished, Natural, Natural Amaretto Crème Penned, Natural Toasted Almond Penned, Alpaca, Black Canyon, Worn Beachglass, or Worn Black. Not available with the brushed finish technique.

Extra Hewn

This more aggressive technique features burnished sand-through on corners and raised profiles along with sanding on sharp profiles to expose underlying wood for all species and colors in the Diamond Edge line. Unlike Hewn, Extra Hewn is a RANDOM sand-through technique varying the number of corners and raised profiles receiving burnished sand-through and the sanding of sharp profiles. As with normal aging, the worn edges will vary within individual doors and throughout the entire room. The technique will be applied to doors, drawer fronts, overlays, mouldings, and embellishments where corners and sharp profiles are applicable. Face frames, panels, straight fillers, and plywood will NOT get the application. Additional inclusions or exclusions may apply. Extra Hewn is not available on Unfinished, Natural, Natural Amaretto Crème Penned, Natural Toasted Almond Penned, Alpaca, Black Canyon, Worn Beachglass, or Worn Black. Not available with the brushed finish technique.

Available combinations are Extra Timeworn with Extra Hewn and Timeworn with Hewn.







Stain Finish Process

1. Diamond Edge's craftspeople carefully inspect each cabinet piece to ensure that the wood is in excellent condition and ready for finish application.
2. Multiple sanding processes prepare selected woods for a quality finish. Sanding steps include shaping, jitter sanding, wide belt sanding, and cross grain sanding.
3. Toner is applied. Toner is a base coat that provides initial color and helps to equalize the surface of the wood.
4. Skilled craftspeople carefully apply the selected stain.
5. The stain is hand-wiped into the wood's surface, highlighting the beauty of the grain patterns.
- 6.* The wood enters the oven for the first time to seal the stain.
- 7.* Sealer is applied, ensuring that the toner and stain are locked in, protecting the rich wood tones.
- 8.* The wood enters the oven for the second time in the finish process, adding greater finish durability.
9. The sealer is sanded to ensure a completely smooth surface for the top coat application.
10. The wood is wiped down with a tack cloth to make sure that the wood surface is exceptionally clean.
11. The wood enters the oven for the third time in the finish process, adding greater finish durability.
12. After the third surface preparation, the final protective top coat of catalyzed conversion varnish is applied.
13. Finally, the piece is ready for the last step in the finish process, where it travels through the oven for the fourth time, ensuring years of carefree beauty.

An unfinished door receives the normal white wood sanding process, but is re-sanded in the field just prior to finish application. Diamond Edge does not warranty finish on cabinets that have been finished by an outside source.

*Does not apply for natural finish.

Door Style & Finish Availability Chart

		Standard Sheen	Matte Sheen Option [†]	Upcharge	Alder Door Styles	Cherry Door Styles	Maple Door Styles ☞ ¹	 MDF Door Styles ☞ ¹	Quartersawn Oak Door Styles ☞ ¹	Rustic Alder Door Styles ☞ ²	 Walnut Door Styles
Stains	Boardwalk	15°	5°	0%	✓^	✓^	✓^		✓	✓^	✓^
	Boulder	15°	5°	0%	✓^	✓^	✓^		✓	✓^	✓^
	Buckskin	15°	5°	0%	✓^	✓^	✓^		✓	✓^	✓^
	Cattail	15°	5°	0%	✓^	✓^	✓^		✓	✓^	✓^
	Chocolate	15°	5°	0%	✓^	✓^	✓^		✓	✓^	✓^
	Colt 	15°	5°	0%	✓^	✓^	✓^		✓	✓^	✓^
	Havana	15°	5°	0%	✓^	✓^	✓^		✓	✓^	✓^
	Henna	15°	5°	0%	✓^	✓^	✓^		✓	✓^	✓^
	Marsala	35°	5°	0%	✓^	✓^	✓^		✓	✓^	✓^
	Morel	15°	5°	0%	✓^	✓^	✓^		✓	✓^	✓^
	Mustang	35°	5°	0%	✓^	✓^	✓^		✓	✓^	✓^
	Natural	35°	5°	0%	✓^	✓^	✓^		✓	✓^	✓^
	Rodeo	15°	5°	0%	✓^	✓^	✓^		✓	✓^	✓^
	Sahara	15°	5°	0%	✓^	✓^	✓^		✓	✓^	✓^
	Sandpiper	35°	5°	0%	✓^	✓^	✓^		✓	✓^	✓^
	Seal	15°	5°	0%	✓^	✓^	✓^		✓	✓^	✓^
	Single Malt	35°	5°	0%	✓^	✓^	✓^		✓	✓^	✓^
	Stout	35°	5°	0%	✓^	✓^	✓^		✓	✓^	✓^
Thatch	15°	5°	0%	✓^	✓^	✓^		✓	✓^	✓^	
Tundra	15°	5°	0%	✓^	✓^	✓^		✓	✓^	✓^	
Unfinished			0%	✓	✓	✓		✓	✓	✓	
Flooded Glazes	Marsala Amaretto Crème	35°	5°	12%	✓	✓			✓	✓	✓
	Natural Toasted Almond	35°	5°	12%	✓	✓	✓			✓	✓
	Ruddy Toasted Almond	35°	5°	12%	✓	✓				✓	✓
	Rye Amaretto Crème	35°	5°	12%		✓					✓
	Rye Toasted Almond	35°	5°	12%	✓	✓	✓		✓	✓	✓
	Sandpiper Amaretto Crème	35°	5°	12%	✓	✓				✓	✓
Paints***	Paints***	15°	5°	12%			✓*	✓	✓		
Sherwin-Williams® Color	Sherwin-Williams® Color Palette 	15°	5°	15%			✓*	✓	✓		
Specialties	Alpaca	15°	5°	12%			✓		✓		✓
	Balsamic Ombre	15°	5°	12%	✓	✓				✓	✓
	Beachglass	15°	5°	12%			✓		✓		
	Black Canyon	15°	5°	12%			✓**				
	Cigar Box	15°	5°	12%	✓	✓			✓	✓	✓
	Cordial Ombre	15°	5°	12%	✓	✓				✓	✓
	Driftwood	15°	5°	15%	✓	✓	✓		✓	✓	✓
	Dunes 	5°	15%		✓	✓			✓	✓	✓
	Poppyseed	15°	5°	15%			✓^				✓^
	Thicket 	5°	15%		✓	✓			✓	✓	✓
	Worn Beachglass	15°	5°	12%			✓		✓	✓	
Worn Black	15°	5°	12%			✓**					
Cerused Finishes	Buckskin Brindle	5°		12%					✓		✓
	Buckskin Roan	5°		12%					✓		✓
	Morel Brindle	5°		12%					✓		✓
	Morel Roan	5°		12%					✓		✓
	Seal Brindle	5°		12%					✓		✓
	Seal Roan	5°		12%					✓		✓

For Finish Descriptions and availability details, see pages E•1 through E•4.

*Available with Amaretto Crème, Grey Stone, Meringue, Nougat, Smoked Caviar, and Toasted Almond panned glazes at an additional 15% upcharge. These highlight options are not available on the Trystan door style.

**Not available on Trystan.

***Smoked Caviar panned glaze not available with Black.









†All 5° matte sheens are available as a no charge option.

^Available with Amaretto Crème or Toasted Almond panned glaze at an additional 12% upcharge. These highlight options are not available on the Trystan door style.

☞¹ Signed finish agreement required, see page V•6.

☞² Signed Rustic Alder agreement required, see page V•7.

Paints Finish Chart

		Standard Sheen	Matte Sheen Option†	Upcharge	Alder Door Styles	Cherry Door Styles	Maple Door Styles  1	 MDF Door Styles  1	Quartersawn Oak Door Styles  1	Rustic Alder Door Styles  2	 Walnut Door Styles
Techniques	Hewn**			5%	✓	✓	✓		✓	✓	✓
	Extra Hewn**			5%	✓	✓	✓		✓	✓	✓
	Timeworn**			5%	✓	✓	✓		✓	✓	✓
	Extra Timeworn**			5%	✓	✓	✓		✓	✓	✓
Paints	Abyss	15°	5°	12%			✓*	✓	✓		
	Agreeable Gray	15°	5°	12%			✓*	✓	✓		
	Black***	15°	5°	12%			✓*	✓	✓		
	Cloud	15°	5°	12%			✓*	✓	✓		
	Coastal Plain	15°	5°	12%			✓*	✓	✓		
	Coconut	15°	5°	12%			✓*	✓	✓		
	Distance	15°	5°	12%			✓*	✓	✓		
	Dover	15°	5°	12%			✓*	✓	✓		
	Egret	15°	5°	12%			✓*	✓	✓		
	Escape Gray	15°	5°	12%			✓*	✓	✓		
	Forest Floor	15°	5°	12%			✓*	✓	✓		
	Foxhall Green 	15°	5°	12%			✓*	✓	✓		
	Icy Avalanche	15°	5°	12%			✓*	✓	✓		
	Interesting Aqua	15°	5°	12%			✓*	✓	✓		
	Juniper Berry	15°	5°	12%			✓*	✓	✓		
	Lambswool	15°	5°	12%			✓*	✓	✓		
	Limestone	15°	5°	12%			✓*	✓	✓		
	Living Greige	15°	5°	12%			✓*	✓	✓		
	Maritime	15°	5°	12%			✓*	✓	✓		
	Mindful Gray	15°	5°	12%			✓*	✓	✓		
	Moonstone	15°	5°	12%			✓*	✓	✓		
	Naval	15°	5°	12%			✓*	✓	✓		
	North Star	15°	5°	12%			✓*	✓	✓		
	Peppercorn	15°	5°	12%			✓*	✓	✓		
	Retreat	15°	5°	12%			✓*	✓	✓		
Sea Salt	15°	5°	12%			✓*	✓	✓			
Seaside	15°	5°	12%			✓*	✓	✓			
Serious Gray 	15°	5°	12%			✓*	✓	✓			
Sterling White	15°	5°	12%			✓*	✓	✓			
White	15°	5°	12%			✓*	✓	✓			
Sherwin-Williams® Color	Sherwin-Williams® Color Palette 	15°	5°	15%			✓*	✓	✓		
Brushed Finishes	Brushed Lakeshore	15°	5°	20%			✓	✓			
	Brushed Nightfall	15°	5°	20%			✓	✓			
	Brushed Timber	15°	5°	20%			✓	✓			

For Finish Descriptions and availability details, see pages E•1 through E•4.

Signed Finish Agreement forms required for Paints and Brushed Finishes. Sample door sign off required for Brushed Finishes. See page V•6.

Brushed Finishes must be ordered along with a painted finish as the base color. Example: Coconut (12%) plus Brushed Nightfall (20%).

*Available with Amaretto Crème, Grey Stone, Meringue, Nougat, Smoked Caviar, and Toasted Almond panned glazes at an additional 15% upcharge. These highlight options are not available on the Trystan door style.

**Not available on Trystan.

***Smoked Caviar panned glaze not available with Black.

†All 5° matte sheens are available as a no charge option.

 1 Signed finish agreement required, see page V•6.

 2 Signed Rustic Alder agreement required, see page V•7.

Finish Accessories

FINISH / GLAZE NAME	Toner	Stain	Glaze	Paint	Glaze Pen	Spray Can*	Touch-up Kit
Stains							
Boardwalk	(1) TONERQUART	(1) STAINQUART				(1) SSC15**	(1) TUK
Boardwalk Amaretto Crème	(1) TONERQUART	(1) STAINQUART			(1) GLAZEPEN	(1) SSC15**	(1) TUK
Boardwalk Toasted Almond	(1) TONERQUART	(1) STAINQUART			(1) GLAZEPEN	(1) SSC15**	(1) TUK
Boulder	(1) TONERQUART	(1) STAINQUART				(1) SSC15**	(1) TUK
Boulder Amaretto Crème	(1) TONERQUART	(1) STAINQUART			(1) GLAZEPEN	(1) SSC15**	(1) TUK
Boulder Toasted Almond	(1) TONERQUART	(1) STAINQUART			(1) GLAZEPEN	(1) SSC15**	(1) TUK
Buckskin	(1) TONERQUART	(1) STAINQUART				(1) SSC15**	(1) TUK
Buckskin Amaretto Crème	(1) TONERQUART	(1) STAINQUART			(1) GLAZEPEN	(1) SSC15**	(1) TUK
Buckskin Toasted Almond	(1) TONERQUART	(1) STAINQUART			(1) GLAZEPEN	(1) SSC15**	(1) TUK
Cattail	(1) TONERQUART	(1) STAINQUART				(1) SSC15**	(1) TUK
Cattail Amaretto Crème	(1) TONERQUART	(1) STAINQUART			(1) GLAZEPEN	(1) SSC15**	(1) TUK
Cattail Toasted Almond	(1) TONERQUART	(1) STAINQUART			(1) GLAZEPEN	(1) SSC15**	(1) TUK
Chocolate	(1) TONERQUART	(1) STAINQUART				(1) SSC15**	(1) TUK
Chocolate Amaretto Crème	(1) TONERQUART	(1) STAINQUART			(1) GLAZEPEN	(1) SSC15**	(1) TUK
Chocolate Toasted Almond	(1) TONERQUART	(1) STAINQUART			(1) GLAZEPEN	(1) SSC15**	(1) TUK
Colt	(1) TONERQUART	(1) STAINQUART				(1) SSC15**	(1) TUK
Colt Amaretto Crème	(1) TONERQUART	(1) STAINQUART			(1) GLAZEPEN	(1) SSC15**	(1) TUK
Colt Toasted Almond	(1) TONERQUART	(1) STAINQUART			(1) GLAZEPEN	(1) SSC15**	(1) TUK
Havana	(1) TONERQUART	(1) STAINQUART				(1) SSC15**	(1) TUK
Havana Amaretto Crème	(1) TONERQUART	(1) STAINQUART			(1) GLAZEPEN	(1) SSC15**	(1) TUK
Havana Toasted Almond	(1) TONERQUART	(1) STAINQUART			(1) GLAZEPEN	(1) SSC15**	(1) TUK
Henna	(1) TONERQUART	(1) STAINQUART				(1) SSC15**	(1) TUK
Henna Amaretto Crème	(1) TONERQUART	(1) STAINQUART			(1) GLAZEPEN	(1) SSC15**	(1) TUK
Henna Toasted Almond	(1) TONERQUART	(1) STAINQUART			(1) GLAZEPEN	(1) SSC15**	(1) TUK
Marsala	(1) TONERQUART	(1) STAINQUART				(1) SSC35**	(1) TUK
Marsala Amaretto Crème	(1) TONERQUART	(1) STAINQUART			(1) GLAZEPEN	(1) SSC35**	(1) TUK
Marsala Toasted Almond	(1) TONERQUART	(1) STAINQUART			(1) GLAZEPEN	(1) SSC35**	(1) TUK
Morel	(1) TONERQUART	(1) STAINQUART				(1) SSC15**	(1) TUK
Morel Amaretto Crème	(1) TONERQUART	(1) STAINQUART			(1) GLAZEPEN	(1) SSC15**	(1) TUK
Morel Toasted Almond	(1) TONERQUART	(1) STAINQUART			(1) GLAZEPEN	(1) SSC15**	(1) TUK
Mustang	(1) TONERQUART	(1) STAINQUART				(1) SSC35**	(1) TUK
Mustang Amaretto Crème	(1) TONERQUART	(1) STAINQUART			(1) GLAZEPEN	(1) SSC35**	(1) TUK
Mustang Toasted Almond	(1) TONERQUART	(1) STAINQUART			(1) GLAZEPEN	(1) SSC35**	(1) TUK
Natural						(1) SSC35**	(1) TUK
Natural Amaretto Crème					(1) GLAZEPEN	(1) SSC35**	(1) TUK
Natural Toasted Almond					(1) GLAZEPEN	(1) SSC35**	(1) TUK
Rodeo	(1) TONERQUART	(1) STAINQUART				(1) SSC15**	(1) TUK
Rodeo Amaretto Crème	(1) TONERQUART	(1) STAINQUART			(1) GLAZEPEN	(1) SSC15**	(1) TUK
Rodeo Toasted Almond	(1) TONERQUART	(1) STAINQUART			(1) GLAZEPEN	(1) SSC15**	(1) TUK
Sahara	(1) TONERQUART	(1) STAINQUART				(1) SSC15**	(1) TUK
Sahara Amaretto Crème	(1) TONERQUART	(1) STAINQUART			(1) GLAZEPEN	(1) SSC15**	(1) TUK
Sahara Toasted Almond	(1) TONERQUART	(1) STAINQUART			(1) GLAZEPEN	(1) SSC15**	(1) TUK
Sandpiper		(1) STAINQUART				(1) SSC35**	(1) TUK
Sandpiper Amaretto Crème		(1) STAINQUART			(1) GLAZEPEN	(1) SSC35**	(1) TUK
Sandpiper Toasted Almond		(1) STAINQUART			(1) GLAZEPEN	(1) SSC35**	(1) TUK
Seal	(1) TONERQUART	(1) STAINQUART				(1) SSC15**	(1) TUK
Seal Amaretto Crème	(1) TONERQUART	(1) STAINQUART			(1) GLAZEPEN	(1) SSC15**	(1) TUK
Seal Toasted Almond	(1) TONERQUART	(1) STAINQUART			(1) GLAZEPEN	(1) SSC15**	(1) TUK
Single Malt	(1) TONERQUART	(1) STAINQUART				(1) SSC35**	(1) TUK
Single Malt Amaretto Crème	(1) TONERQUART	(1) STAINQUART			(1) GLAZEPEN	(1) SSC35**	(1) TUK
Single Malt Toasted Almond	(1) TONERQUART	(1) STAINQUART			(1) GLAZEPEN	(1) SSC35**	(1) TUK
Stout	(1) TONERQUART	(1) STAINQUART				(1) SSC35**	(1) TUK
Stout Amaretto Crème	(1) TONERQUART	(1) STAINQUART			(1) GLAZEPEN	(1) SSC35**	(1) TUK
Stout Toasted Almond	(1) TONERQUART	(1) STAINQUART			(1) GLAZEPEN	(1) SSC35**	(1) TUK
Thatch	(1) TONERQUART	(1) STAINQUART				(1) SSC15**	(1) TUK
Thatch Amaretto Crème	(1) TONERQUART	(1) STAINQUART			(1) GLAZEPEN	(1) SSC15**	(1) TUK
Thatch Toasted Almond	(1) TONERQUART	(1) STAINQUART			(1) GLAZEPEN	(1) SSC15**	(1) TUK
Tundra	(1) TONERQUART	(1) STAINQUART				(1) SSC15**	(1) TUK
Tundra Amaretto Crème	(1) TONERQUART	(1) STAINQUART			(1) GLAZEPEN	(1) SSC15**	(1) TUK
Tundra Toasted Almond	(1) TONERQUART	(1) STAINQUART			(1) GLAZEPEN	(1) SSC15**	(1) TUK

*Spray Can accessory is a clear coat material.

**If matte sheen option is selected, then spray can code SSC5 will need to be selected instead of the spray can code listed in chart.

FINISH / GLAZE NAME	Toner	Stain	Glaze	Paint	Glaze Pen	Spray Can*	Touch-up Kit
Flooded Glazes							
Marsala Amaretto Crème	(1) TONERQUART		(1) GLAZEQUART			(1) SSC35**	(1) TUK
Natural Toasted Almond	(1) TONERQUART		(1) GLAZEQUART			(1) SSC35**	(1) TUK
Ruddy Toasted Almond	(1) TONERQUART		(1) GLAZEQUART			(1) SSC35**	(1) TUK
Rye Amaretto Crème	(1) TONERQUART		(1) GLAZEQUART			(1) SSC35**	(1) TUK
Rye Toasted Almond	(1) TONERQUART		(1) GLAZEQUART			(1) SSC35**	(1) TUK
Sandpiper Amaretto Crème	(1) TONERQUART		(1) GLAZEQUART			(1) SSC35**	(1) TUK
Paints							
Abyss				(1) PAINTQUART		(1) SSC15**	(1) TUK
Abyss Amaretto Crème				(1) PAINTQUART	(1) GLAZEPEN	(1) SSC15**	(1) TUK
Abyss Grey Stone				(1) PAINTQUART	(1) GLAZEPEN	(1) SSC15**	(1) TUK
Abyss Meringue				(1) PAINTQUART	(1) GLAZEPEN	(1) SSC15**	(1) TUK
Abyss Nougat				(1) PAINTQUART	(1) GLAZEPEN	(1) SSC15**	(1) TUK
Abyss Smoked Caviar				(1) PAINTQUART	(1) GLAZEPEN	(1) SSC15**	(1) TUK
Abyss Toasted Almond				(1) PAINTQUART	(1) GLAZEPEN	(1) SSC15**	(1) TUK
Agreeable Gray				(1) PAINTQUART		(1) SSC15**	(1) TUK
Agreeable Gray Amaretto Crème				(1) PAINTQUART	(1) GLAZEPEN	(1) SSC15**	(1) TUK
Agreeable Gray Grey Stone				(1) PAINTQUART	(1) GLAZEPEN	(1) SSC15**	(1) TUK
Agreeable Gray Meringue				(1) PAINTQUART	(1) GLAZEPEN	(1) SSC15**	(1) TUK
Agreeable Gray Nougat				(1) PAINTQUART	(1) GLAZEPEN	(1) SSC15**	(1) TUK
Agreeable Gray Smoked Caviar				(1) PAINTQUART	(1) GLAZEPEN	(1) SSC15**	(1) TUK
Agreeable Gray Toasted Almond				(1) PAINTQUART	(1) GLAZEPEN	(1) SSC15**	(1) TUK
Black	(1) TONERQUART					(1) SSC15**	(1) TUK
Black Amaretto Crème	(1) TONERQUART				(1) GLAZEPEN	(1) SSC15**	(1) TUK
Black Grey Stone	(1) TONERQUART				(1) GLAZEPEN	(1) SSC15**	(1) TUK
Black Meringue	(1) TONERQUART				(1) GLAZEPEN	(1) SSC15**	(1) TUK
Black Nougat	(1) TONERQUART				(1) GLAZEPEN	(1) SSC15**	(1) TUK
Black Toasted Almond	(1) TONERQUART				(1) GLAZEPEN	(1) SSC15**	(1) TUK
Cloud				(1) PAINTQUART		(1) SSC15**	(1) TUK
Cloud Amaretto Crème				(1) PAINTQUART	(1) GLAZEPEN	(1) SSC15**	(1) TUK
Cloud Grey Stone				(1) PAINTQUART	(1) GLAZEPEN	(1) SSC15**	(1) TUK
Cloud Meringue				(1) PAINTQUART	(1) GLAZEPEN	(1) SSC15**	(1) TUK
Cloud Nougat				(1) PAINTQUART	(1) GLAZEPEN	(1) SSC15**	(1) TUK
Cloud Smoked Caviar				(1) PAINTQUART	(1) GLAZEPEN	(1) SSC15**	(1) TUK
Cloud Toasted Almond				(1) PAINTQUART	(1) GLAZEPEN	(1) SSC15**	(1) TUK
Coastal Plain				(1) PAINTQUART		(1) SSC15**	(1) TUK
Coastal Plain Amaretto Crème				(1) PAINTQUART	(1) GLAZEPEN	(1) SSC15**	(1) TUK
Coastal Plain Grey Stone				(1) PAINTQUART	(1) GLAZEPEN	(1) SSC15**	(1) TUK
Coastal Plain Meringue				(1) PAINTQUART	(1) GLAZEPEN	(1) SSC15**	(1) TUK
Coastal Plain Nougat				(1) PAINTQUART	(1) GLAZEPEN	(1) SSC15**	(1) TUK
Coastal Plain Smoked Caviar				(1) PAINTQUART	(1) GLAZEPEN	(1) SSC15**	(1) TUK
Coastal Plain Toasted Almond				(1) PAINTQUART	(1) GLAZEPEN	(1) SSC15**	(1) TUK
Coconut				(1) PAINTQUART		(1) SSC15**	(1) TUK
Coconut Amaretto Crème				(1) PAINTQUART	(1) GLAZEPEN	(1) SSC15**	(1) TUK
Coconut Grey Stone				(1) PAINTQUART	(1) GLAZEPEN	(1) SSC15**	(1) TUK
Coconut Meringue				(1) PAINTQUART	(1) GLAZEPEN	(1) SSC15**	(1) TUK
Coconut Nougat				(1) PAINTQUART	(1) GLAZEPEN	(1) SSC15**	(1) TUK
Coconut Smoked Caviar				(1) PAINTQUART	(1) GLAZEPEN	(1) SSC15**	(1) TUK
Coconut Toasted Almond				(1) PAINTQUART	(1) GLAZEPEN	(1) SSC15**	(1) TUK
Distance				(1) PAINTQUART		(1) SSC15**	(1) TUK
Distance Amaretto Crème				(1) PAINTQUART	(1) GLAZEPEN	(1) SSC15**	(1) TUK
Distance Grey Stone				(1) PAINTQUART	(1) GLAZEPEN	(1) SSC15**	(1) TUK
Distance Meringue				(1) PAINTQUART	(1) GLAZEPEN	(1) SSC15**	(1) TUK
Distance Nougat				(1) PAINTQUART	(1) GLAZEPEN	(1) SSC15**	(1) TUK
Distance Smoked Caviar				(1) PAINTQUART	(1) GLAZEPEN	(1) SSC15**	(1) TUK
Distance Toasted Almond				(1) PAINTQUART	(1) GLAZEPEN	(1) SSC15**	(1) TUK
Dover				(1) PAINTQUART		(1) SSC15**	(1) TUK
Dover Amaretto Crème				(1) PAINTQUART	(1) GLAZEPEN	(1) SSC15**	(1) TUK
Dover Grey Stone				(1) PAINTQUART	(1) GLAZEPEN	(1) SSC15**	(1) TUK
Dover Meringue				(1) PAINTQUART	(1) GLAZEPEN	(1) SSC15**	(1) TUK
Dover Nougat				(1) PAINTQUART	(1) GLAZEPEN	(1) SSC15**	(1) TUK
Dover Smoked Caviar				(1) PAINTQUART	(1) GLAZEPEN	(1) SSC15**	(1) TUK
Dover Toasted Almond				(1) PAINTQUART	(1) GLAZEPEN	(1) SSC15**	(1) TUK

*Spray Can accessory is a clear coat material.

**If matte sheen option is selected, then spray can code SSC5 will need to be selected instead of the spray can code listed in chart.

Finish Accessories

FINISH / GLAZE NAME	Toner	Stain	Glaze	Paint	Glaze Pen	Spray Can*	Touch-up Kit
Egret				(1) PAINTQUART		(1) SSC15**	(1) TUK
Egret Amaretto Crème				(1) PAINTQUART	(1) GLAZEPEN	(1) SSC15**	(1) TUK
Egret Grey Stone				(1) PAINTQUART	(1) GLAZEPEN	(1) SSC15**	(1) TUK
Egret Meringue				(1) PAINTQUART	(1) GLAZEPEN	(1) SSC15**	(1) TUK
Egret Nougat				(1) PAINTQUART	(1) GLAZEPEN	(1) SSC15**	(1) TUK
Egret Smoked Caviar				(1) PAINTQUART	(1) GLAZEPEN	(1) SSC15**	(1) TUK
Egret Toasted Almond				(1) PAINTQUART	(1) GLAZEPEN	(1) SSC15**	(1) TUK
Escape Gray				(1) PAINTQUART		(1) SSC15**	(1) TUK
Escape Gray Amaretto Crème				(1) PAINTQUART	(1) GLAZEPEN	(1) SSC15**	(1) TUK
Escape Gray Grey Stone				(1) PAINTQUART	(1) GLAZEPEN	(1) SSC15**	(1) TUK
Escape Gray Meringue				(1) PAINTQUART	(1) GLAZEPEN	(1) SSC15**	(1) TUK
Escape Gray Nougat				(1) PAINTQUART	(1) GLAZEPEN	(1) SSC15**	(1) TUK
Escape Gray Smoked Caviar				(1) PAINTQUART	(1) GLAZEPEN	(1) SSC15**	(1) TUK
Escape Gray Toasted Almond				(1) PAINTQUART	(1) GLAZEPEN	(1) SSC15**	(1) TUK
Forest Floor				(1) PAINTQUART		(1) SSC15**	(1) TUK
Forest Floor Amaretto Crème				(1) PAINTQUART	(1) GLAZEPEN	(1) SSC15**	(1) TUK
Forest Floor Grey Stone				(1) PAINTQUART	(1) GLAZEPEN	(1) SSC15**	(1) TUK
Forest Floor Meringue				(1) PAINTQUART	(1) GLAZEPEN	(1) SSC15**	(1) TUK
Forest Floor Nougat				(1) PAINTQUART	(1) GLAZEPEN	(1) SSC15**	(1) TUK
Forest Floor Smoked Caviar				(1) PAINTQUART	(1) GLAZEPEN	(1) SSC15**	(1) TUK
Forest Floor Toasted Almond				(1) PAINTQUART	(1) GLAZEPEN	(1) SSC15**	(1) TUK
Foxhall Green				(1) PAINTQUART		(1) SSC15**	(1) TUK
Foxhall Green Amaretto Crème				(1) PAINTQUART	(1) GLAZEPEN	(1) SSC15**	(1) TUK
Foxhall Green Grey Stone				(1) PAINTQUART	(1) GLAZEPEN	(1) SSC15**	(1) TUK
Foxhall Green Meringue				(1) PAINTQUART	(1) GLAZEPEN	(1) SSC15**	(1) TUK
Foxhall Green Nougat				(1) PAINTQUART	(1) GLAZEPEN	(1) SSC15**	(1) TUK
Foxhall Green Smoked Caviar				(1) PAINTQUART	(1) GLAZEPEN	(1) SSC15**	(1) TUK
Foxhall Green Toasted Almond				(1) PAINTQUART	(1) GLAZEPEN	(1) SSC15**	(1) TUK
Icy Avalanche				(1) PAINTQUART		(1) SSC15**	(1) TUK
Icy Avalanche Amaretto Crème				(1) PAINTQUART	(1) GLAZEPEN	(1) SSC15**	(1) TUK
Icy Avalanche Grey Stone				(1) PAINTQUART	(1) GLAZEPEN	(1) SSC15**	(1) TUK
Icy Avalanche Meringue				(1) PAINTQUART	(1) GLAZEPEN	(1) SSC15**	(1) TUK
Icy Avalanche Nougat				(1) PAINTQUART	(1) GLAZEPEN	(1) SSC15**	(1) TUK
Icy Avalanche Smoked Caviar				(1) PAINTQUART	(1) GLAZEPEN	(1) SSC15**	(1) TUK
Icy Avalanche Toasted Almond				(1) PAINTQUART	(1) GLAZEPEN	(1) SSC15**	(1) TUK
Interesting Aqua				(1) PAINTQUART		(1) SSC15**	(1) TUK
Interesting Aqua Amaretto Crème				(1) PAINTQUART	(1) GLAZEPEN	(1) SSC15**	(1) TUK
Interesting Aqua Grey Stone				(1) PAINTQUART	(1) GLAZEPEN	(1) SSC15**	(1) TUK
Interesting Aqua Meringue				(1) PAINTQUART	(1) GLAZEPEN	(1) SSC15**	(1) TUK
Interesting Aqua Nougat				(1) PAINTQUART	(1) GLAZEPEN	(1) SSC15**	(1) TUK
Interesting Aqua Smoked Caviar				(1) PAINTQUART	(1) GLAZEPEN	(1) SSC15**	(1) TUK
Interesting Aqua Toasted Almond				(1) PAINTQUART	(1) GLAZEPEN	(1) SSC15**	(1) TUK
Juniper Berry				(1) PAINTQUART		(1) SSC15**	(1) TUK
Juniper Berry Amaretto Crème				(1) PAINTQUART	(1) GLAZEPEN	(1) SSC15**	(1) TUK
Juniper Berry Grey Stone				(1) PAINTQUART	(1) GLAZEPEN	(1) SSC15**	(1) TUK
Juniper Berry Meringue				(1) PAINTQUART	(1) GLAZEPEN	(1) SSC15**	(1) TUK
Juniper Berry Nougat				(1) PAINTQUART	(1) GLAZEPEN	(1) SSC15**	(1) TUK
Juniper Berry Smoked Caviar				(1) PAINTQUART	(1) GLAZEPEN	(1) SSC15**	(1) TUK
Juniper Berry Toasted Almond				(1) PAINTQUART	(1) GLAZEPEN	(1) SSC15**	(1) TUK
Lambswool				(1) PAINTQUART		(1) SSC15**	(1) TUK
Lambswool Amaretto Crème				(1) PAINTQUART	(1) GLAZEPEN	(1) SSC15**	(1) TUK
Lambswool Grey Stone				(1) PAINTQUART	(1) GLAZEPEN	(1) SSC15**	(1) TUK
Lambswool Meringue				(1) PAINTQUART	(1) GLAZEPEN	(1) SSC15**	(1) TUK
Lambswool Nougat				(1) PAINTQUART	(1) GLAZEPEN	(1) SSC15**	(1) TUK
Lambswool Smoked Caviar				(1) PAINTQUART	(1) GLAZEPEN	(1) SSC15**	(1) TUK
Lambswool Toasted Almond				(1) PAINTQUART	(1) GLAZEPEN	(1) SSC15**	(1) TUK
Limestone				(1) PAINTQUART		(1) SSC15**	(1) TUK
Limestone Amaretto Crème				(1) PAINTQUART	(1) GLAZEPEN	(1) SSC15**	(1) TUK
Limestone Grey Stone				(1) PAINTQUART	(1) GLAZEPEN	(1) SSC15**	(1) TUK
Limestone Meringue				(1) PAINTQUART	(1) GLAZEPEN	(1) SSC15**	(1) TUK
Limestone Nougat				(1) PAINTQUART	(1) GLAZEPEN	(1) SSC15**	(1) TUK
Limestone Smoked Caviar				(1) PAINTQUART	(1) GLAZEPEN	(1) SSC15**	(1) TUK
Limestone Toasted Almond				(1) PAINTQUART	(1) GLAZEPEN	(1) SSC15**	(1) TUK

*Spray Can accessory is a clear coat material.

**If matte sheen option is selected, then spray can code SSC5 will need to be selected instead of the spray can code listed in chart.

FINISH / GLAZE NAME	Toner	Stain	Glaze	Paint	Glaze Pen	Spray Can*	Touch-up Kit
Living Greige				(1) PAINTQUART		(1) SSC15**	(1) TUK
Living Greige Amaretto Crème				(1) PAINTQUART	(1) GLAZEPEN	(1) SSC15**	(1) TUK
Living Greige Grey Stone				(1) PAINTQUART	(1) GLAZEPEN	(1) SSC15**	(1) TUK
Living Greige Meringue				(1) PAINTQUART	(1) GLAZEPEN	(1) SSC15**	(1) TUK
Living Greige Nougat				(1) PAINTQUART	(1) GLAZEPEN	(1) SSC15**	(1) TUK
Living Greige Smoked Caviar				(1) PAINTQUART	(1) GLAZEPEN	(1) SSC15**	(1) TUK
Living Greige Toasted Almond				(1) PAINTQUART	(1) GLAZEPEN	(1) SSC15**	(1) TUK
Maritime				(1) PAINTQUART		(1) SSC15**	(1) TUK
Maritime Amaretto Crème				(1) PAINTQUART	(1) GLAZEPEN	(1) SSC15**	(1) TUK
Maritime Grey Stone				(1) PAINTQUART	(1) GLAZEPEN	(1) SSC15**	(1) TUK
Maritime Meringue				(1) PAINTQUART	(1) GLAZEPEN	(1) SSC15**	(1) TUK
Maritime Nougat				(1) PAINTQUART	(1) GLAZEPEN	(1) SSC15**	(1) TUK
Maritime Smoked Caviar				(1) PAINTQUART	(1) GLAZEPEN	(1) SSC15**	(1) TUK
Maritime Toasted Almond				(1) PAINTQUART	(1) GLAZEPEN	(1) SSC15**	(1) TUK
Mindful Gray				(1) PAINTQUART		(1) SSC15**	(1) TUK
Mindful Gray Amaretto Crème				(1) PAINTQUART	(1) GLAZEPEN	(1) SSC15**	(1) TUK
Mindful Gray Grey Stone				(1) PAINTQUART	(1) GLAZEPEN	(1) SSC15**	(1) TUK
Mindful Gray Meringue				(1) PAINTQUART	(1) GLAZEPEN	(1) SSC15**	(1) TUK
Mindful Gray Nougat				(1) PAINTQUART	(1) GLAZEPEN	(1) SSC15**	(1) TUK
Mindful Gray Smoked Caviar				(1) PAINTQUART	(1) GLAZEPEN	(1) SSC15**	(1) TUK
Mindful Gray Toasted Almond				(1) PAINTQUART	(1) GLAZEPEN	(1) SSC15**	(1) TUK
Moonstone				(1) PAINTQUART		(1) SSC15**	(1) TUK
Moonstone Amaretto Crème				(1) PAINTQUART	(1) GLAZEPEN	(1) SSC15**	(1) TUK
Moonstone Grey Stone				(1) PAINTQUART	(1) GLAZEPEN	(1) SSC15**	(1) TUK
Moonstone Meringue				(1) PAINTQUART	(1) GLAZEPEN	(1) SSC15**	(1) TUK
Moonstone Nougat				(1) PAINTQUART	(1) GLAZEPEN	(1) SSC15**	(1) TUK
Moonstone Smoked Caviar				(1) PAINTQUART	(1) GLAZEPEN	(1) SSC15**	(1) TUK
Moonstone Toasted Almond				(1) PAINTQUART	(1) GLAZEPEN	(1) SSC15**	(1) TUK
Naval				(1) PAINTQUART		(1) SSC15**	(1) TUK
Naval Amaretto Crème				(1) PAINTQUART	(1) GLAZEPEN	(1) SSC15**	(1) TUK
Naval Grey Stone				(1) PAINTQUART	(1) GLAZEPEN	(1) SSC15**	(1) TUK
Naval Meringue				(1) PAINTQUART	(1) GLAZEPEN	(1) SSC15**	(1) TUK
Naval Nougat				(1) PAINTQUART	(1) GLAZEPEN	(1) SSC15**	(1) TUK
Naval Smoked Caviar				(1) PAINTQUART	(1) GLAZEPEN	(1) SSC15**	(1) TUK
Naval Toasted Almond				(1) PAINTQUART	(1) GLAZEPEN	(1) SSC15**	(1) TUK
North Star				(1) PAINTQUART		(1) SSC15**	(1) TUK
North Star Amaretto Crème				(1) PAINTQUART	(1) GLAZEPEN	(1) SSC15**	(1) TUK
North Star Grey Stone				(1) PAINTQUART	(1) GLAZEPEN	(1) SSC15**	(1) TUK
North Star Meringue				(1) PAINTQUART	(1) GLAZEPEN	(1) SSC15**	(1) TUK
North Star Nougat				(1) PAINTQUART	(1) GLAZEPEN	(1) SSC15**	(1) TUK
North Star Smoked Caviar				(1) PAINTQUART	(1) GLAZEPEN	(1) SSC15**	(1) TUK
North Star Toasted Almond				(1) PAINTQUART	(1) GLAZEPEN	(1) SSC15**	(1) TUK
Peppercorn				(1) PAINTQUART		(1) SSC15**	(1) TUK
Peppercorn Amaretto Crème				(1) PAINTQUART	(1) GLAZEPEN	(1) SSC15**	(1) TUK
Peppercorn Grey Stone				(1) PAINTQUART	(1) GLAZEPEN	(1) SSC15**	(1) TUK
Peppercorn Meringue				(1) PAINTQUART	(1) GLAZEPEN	(1) SSC15**	(1) TUK
Peppercorn Nougat				(1) PAINTQUART	(1) GLAZEPEN	(1) SSC15**	(1) TUK
Peppercorn Smoked Caviar				(1) PAINTQUART	(1) GLAZEPEN	(1) SSC15**	(1) TUK
Peppercorn Toasted Almond				(1) PAINTQUART	(1) GLAZEPEN	(1) SSC15**	(1) TUK
Retreat				(1) PAINTQUART		(1) SSC15**	(1) TUK
Retreat Amaretto Crème				(1) PAINTQUART	(1) GLAZEPEN	(1) SSC15**	(1) TUK
Retreat Grey Stone				(1) PAINTQUART	(1) GLAZEPEN	(1) SSC15**	(1) TUK
Retreat Meringue				(1) PAINTQUART	(1) GLAZEPEN	(1) SSC15**	(1) TUK
Retreat Nougat				(1) PAINTQUART	(1) GLAZEPEN	(1) SSC15**	(1) TUK
Retreat Smoked Caviar				(1) PAINTQUART	(1) GLAZEPEN	(1) SSC15**	(1) TUK
Retreat Toasted Almond				(1) PAINTQUART	(1) GLAZEPEN	(1) SSC15**	(1) TUK
Sea Salt				(1) PAINTQUART		(1) SSC15**	(1) TUK
Sea Salt Amaretto Crème				(1) PAINTQUART	(1) GLAZEPEN	(1) SSC15**	(1) TUK
Sea Salt Grey Stone				(1) PAINTQUART	(1) GLAZEPEN	(1) SSC15**	(1) TUK
Sea Salt Meringue				(1) PAINTQUART	(1) GLAZEPEN	(1) SSC15**	(1) TUK
Sea Salt Nougat				(1) PAINTQUART	(1) GLAZEPEN	(1) SSC15**	(1) TUK
Sea Salt Smoked Caviar				(1) PAINTQUART	(1) GLAZEPEN	(1) SSC15**	(1) TUK
Sea Salt Toasted Almond				(1) PAINTQUART	(1) GLAZEPEN	(1) SSC15**	(1) TUK

*Spray Can accessory is a clear coat material.

**If matte sheen option is selected, then spray can code SSC5 will need to be selected instead of the spray can code listed in chart.

Finish Accessories

FINISH / GLAZE NAME	Toner	Stain	Glaze	Paint	Glaze Pen	Spray Can*	Touch-up Kit
Seaside				(1) PAINTQUART		(1) SSC15**	(1) TUK
Seaside Amaretto Crème				(1) PAINTQUART	(1) GLAZEPEN	(1) SSC15**	(1) TUK
Seaside Grey Stone				(1) PAINTQUART	(1) GLAZEPEN	(1) SSC15**	(1) TUK
Seaside Meringue				(1) PAINTQUART	(1) GLAZEPEN	(1) SSC15**	(1) TUK
Seaside Nougat				(1) PAINTQUART	(1) GLAZEPEN	(1) SSC15**	(1) TUK
Seaside Smoked Caviar				(1) PAINTQUART	(1) GLAZEPEN	(1) SSC15**	(1) TUK
Seaside Toasted Almond				(1) PAINTQUART	(1) GLAZEPEN	(1) SSC15**	(1) TUK
Serious Gray				(1) PAINTQUART		(1) SSC15**	(1) TUK
Serious Gray Amaretto Crème				(1) PAINTQUART	(1) GLAZEPEN	(1) SSC15**	(1) TUK
Serious Gray Grey Stone				(1) PAINTQUART	(1) GLAZEPEN	(1) SSC15**	(1) TUK
Serious Gray Meringue				(1) PAINTQUART	(1) GLAZEPEN	(1) SSC15**	(1) TUK
Serious Gray Nougat				(1) PAINTQUART	(1) GLAZEPEN	(1) SSC15**	(1) TUK
Serious Gray Smoked Caviar				(1) PAINTQUART	(1) GLAZEPEN	(1) SSC15**	(1) TUK
Serious Gray Toasted Almond				(1) PAINTQUART	(1) GLAZEPEN	(1) SSC15**	(1) TUK
Sterling White				(1) PAINTQUART		(1) SSC15**	(1) TUK
Sterling White Amaretto Crème				(1) PAINTQUART	(1) GLAZEPEN	(1) SSC15**	(1) TUK
Sterling White Grey Stone				(1) PAINTQUART	(1) GLAZEPEN	(1) SSC15**	(1) TUK
Sterling White Meringue				(1) PAINTQUART	(1) GLAZEPEN	(1) SSC15**	(1) TUK
Sterling White Nougat				(1) PAINTQUART	(1) GLAZEPEN	(1) SSC15**	(1) TUK
Sterling White Smoked Caviar				(1) PAINTQUART	(1) GLAZEPEN	(1) SSC15**	(1) TUK
Sterling White Toasted Almond				(1) PAINTQUART	(1) GLAZEPEN	(1) SSC15**	(1) TUK
White				(1) PAINTQUART		(1) SSC15**	(1) TUK
White Amaretto Crème				(1) PAINTQUART	(1) GLAZEPEN	(1) SSC15**	(1) TUK
White Grey Stone				(1) PAINTQUART	(1) GLAZEPEN	(1) SSC15**	(1) TUK
White Meringue				(1) PAINTQUART	(1) GLAZEPEN	(1) SSC15**	(1) TUK
White Nougat				(1) PAINTQUART	(1) GLAZEPEN	(1) SSC15**	(1) TUK
White Smoked Caviar				(1) PAINTQUART	(1) GLAZEPEN	(1) SSC15**	(1) TUK
White Toasted Almond				(1) PAINTQUART	(1) GLAZEPEN	(1) SSC15**	(1) TUK
Specialties							
Alpaca				(1) FINKIT		(1) SSC15**	(1) TUK
Balsamic Ombre	(2) TONERQUART		(1) GLAZEQUART			(1) SSC15**	(1) TUK
Beachglass	(1) TONERQUART	(1) STAINQUART				(1) SSC15**	(1) TUK
Black Canyon	(2) TONERQUART					(1) SSC15**	(1) TUK
Cigar Box	(1) TONERQUART		(1) GLAZEQUART			(1) SSC15**	(1) TUK
Cordial Ombre	(1) TONERQUART	(1) STAINQUART				(1) SSC15**	(1) TUK
Driftwood	(1) TONERQUART	(1) STAINQUART				(1) SSC15**	(1) TUK
Dunes	(1) TONERQUART	(1) STAINQUART				(1) SSC5	(1) TUK
Poppyseed	(1) TONERQUART		(1) GLAZEQUART			(1) SSC15**	(1) TUK
Poppyseed Amaretto Crème	(1) TONERQUART		(1) GLAZEQUART		(1) GLAZEPEN	(1) SSC15**	(1) TUK
Poppyseed Toasted Almond	(1) TONERQUART	(1) STAINQUART			(1) GLAZEPEN	(1) SSC15**	(1) TUK
Thicket	(1) TONERQUART	(1) STAINQUART				(1) SSC5	(1) TUK
Worn Beachglass	(1) TONERQUART	(1) STAINQUART				(1) SSC15**	(1) TUK
Worn Black	(1) TONERQUART					(1) SSC15**	(1) TUK
Cerused Finishes							
Buckskin Brindle	(1) TONERQUART	(1) STAINQUART				(1) SSC5	(1) TUK
Buckskin Roan	(1) TONERQUART	(1) STAINQUART				(1) SSC5	(1) TUK
Morel Brindle	(1) TONERQUART	(1) STAINQUART				(1) SSC5	(1) TUK
Morel Roan	(1) TONERQUART	(1) STAINQUART				(1) SSC5	(1) TUK
Seal Brindle	(1) TONERQUART	(1) STAINQUART				(1) SSC5	(1) TUK
Seal Roan	(1) TONERQUART	(1) STAINQUART				(1) SSC5	(1) TUK

*Spray Can accessory is a clear coat material.

**If matte sheen option is selected, then spray can code SSC5 will need to be selected instead of the spray can code listed in chart.

- To order stains, refer to above chart and specify material and color.
- For example, to order Cigar Box, specify (1) TONERQUART Cigar Box and (1) GLAZEQUART Cigar Box.
- All finishes intended for field repair. Not to be used for full cabinet application.
- FINKIT contains 1 pint paint, 1 pint glaze, 1 pint clear top coat and instructions for application.

- To order paints, refer to above chart and specify material and color.
- For example, to order Sterling White, specify (1) PAINTQUART Sterling White.
- To order paints with glaze, refer to above chart and specify material and color.
For example, to order Sterling White Toasted Almond, specify (1) PAINTQUART Sterling White and (1) GLAZEPEN Toasted Almond.

DESCRIPTION	CODE	LIST PRICE
Quart of Toner	TONERQUART	100
Quart of Stain	STAINQUART	106
Quart of Glaze	GLAZEQUART	106
Quart of Paint	PAINTQUART	106
Finish Kit	FINKIT	261
Lacquer Spray Can - 5°	SSC5	68
Lacquer Spray Can - 15°	SSC15	68
Lacquer Spray Can - 35°	SSC35	68
Touch-up Kit	TUK	71
Glaze Pen	GLAZEPEN	34



Cabinet Construction Specifications

1. Cabinet Interiors

Natural wood interior is durable interior and highly resistant to water and most common household chemicals. It's easy-care with a rich, attractive appearance.

2. Shelves

Standard shelves are 3/4" thick Natural plywood with edgebanding on all exposed edges matches the standard interior of the cabinet. All standard shelves are fully adjustable for added customer convenience. (Cabinets ordered with matching interiors feature 3/4" wood veneered shelves.)

3. End Panels

End panels are 1/2" thick Natural plywood. End panels fit into the 1/2" groove on the back side of the face frame and are secured with furniture staples. Flush ends optional.

4. Tops and Bottoms

Tops and bottoms of wall and base cabinets are 1/2" thick Natural plywood. Base bottoms and wall tops and bottoms are dadoed into the end panels and into a groove on the back side of the face frame and are secured with furniture staples.

5. Backs

Backs on all standard base and wall cabinets are 3/16" thick Natural plywood. The back is held securely in a partially-captive groove in the end panel, then furniture stapled and hot melt glued to provide an outstanding, durable joint. For ease of installation, wall cabinets include 3/8" plywood hanger rails, and base cabinets feature an 11/16" pine hanger rail at the top and a 3/8" plywood hanger rail at the bottom. The hanger rails and back are secured to the tops and bottoms with hot melt glue and furniture staples.

(Backs on special corner units and angled units, such as the AEW units, CS units, DW units, and ER units, are constructed of 3/8" furniture core. This material and construction technique adds structural stability to these special units.)

6. Toekicks

A 1/2" plywood sub-toekick is attached between the end panels in all units with a toekick space. The sub-toekick is secured in a 1/8" deep by 17/32" wide groove on the bottom and stapled to the bottom and end panels to hold in place. Toekick skins are available in 8-foot lengths for application to the toekick space after installation for a custom appearance.

7. Corner Blocks

Plywood corner blocks are glued into the grooves on base cabinet face frames and glued and stapled into the grooves in pine hanger rails and end panels. These supports help keep the cabinet square and sturdy and provide a method to attach countertops.

8. Face Frames

Face frames are constructed of 3/4" solid wood using the glue and screw joinery technique. The glue and screw method provides a more consistent joint and has been proven stronger in extensive testing. The "reveal" on the exterior back side of the face frame stile is 9/64", allowing the creation of a flush end when applying 3/32" finished panels for a custom look.

9. Door and Drawer Fronts

Depending upon the style selected, door and drawer fronts may be 3/4" thick solid double raised panels, solid flat panels or one-piece seamless MDF. When Maple painted finishes (Paints, Sherwin-Williams or Brushed Technique) are specified, the center panels of the selected style may be constructed of Medium Density Fiberboard (MDF). MDF provides a smoother finish when painted, and is more resistant to warping, expansion, and contraction. MDF door and drawer front components will be MDF. Face frame and box parts utilize maple paint material, and trim and panels utilize maple species. All door styles include drilled stemmed bumper pads.

10. Hinges

All cabinets use standard concealed hinges, they will vary per door style. Full overlay door styles use a 110 degree 1 5/16" overlay Smart Stop concealed hinge and Inset and Beaded Inset door styles use an inset clip top 110 degree Smart Stop concealed hinge. For all corner type units (i.e. Corner Walls (ER), Base Rotating Deep Bin (BRDB), Lazy Susan Base Cabinets (BLS), Base SuperCabinets™ (BSC), Square Base Corner Cabinets (CS), Square Lazy Susan Base Cabinets (BER), Super Space Savers (SLS)), 170 degree hinges (non Smart Stop) are used in place of the standard hinge. For Inset and Beaded Inset door styles, there is an option to use finial hinges; see modification section for more details.

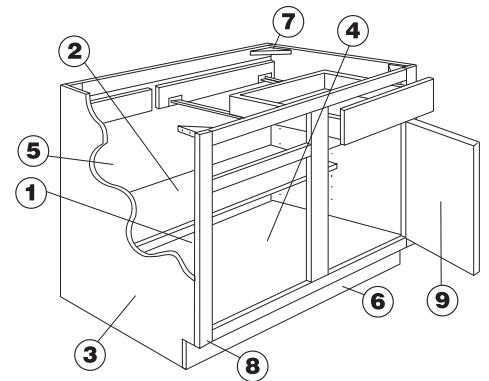

NOTE: Diamond Edge is committed to offering solutions that meet or exceed air emissions rules and regulations. All-plywood used in the construction of our cabinets for end panels, shelves, tops, bottoms, backs, toekicks, and corner blocks is compliant to the California Air Resources Board (CARB) current requirements.

When Maple painted finishes (Paints, Sherwin-Williams or Brushed Technique) are specified, the center panels of the selected style may be constructed of Medium Density Fiberboard (MDF). MDF provides a smoother finish when painted, and is more resistant to warping, expansion, and contraction.

All-plywood components meet ANSI/HPVA HP-1 standards, and may contain MDF or particleboard.

Styles, product availability and construction may vary slightly from those shown in this book due to material availability and/or design evolution. Specifications are subject to change without notice. Customer Service is available if your design requires verification of product availability and specifications.

Specifications & Dimensions

Dovetailed Drawer & Roll Tray Construction Specifications

Drawer and Roll Tray Construction

Drawer and roll tray box sides, backs and fronts are thick solid wood with dovetailed corner construction. Diamond Edge's uses a four-sided drawer and dovetail joinery for superior stability and drawer box strength. Diamond Edge applies an advanced synthetic-based glue to the tenons of all dovetails for even greater stability and box strength. The drawer bottom is 5.2mm veneer plywood and is fully captured within the four sides of the drawer box. Capturing the bottom on four sides provides "solid" drawers and roll trays for optimum load capacity.

Diamond Edge drawer sides, backs and fronts, and bottoms receive a high quality appearance resulting from fine sanding, sealer application, sealer sanding, and top coat application. The result is a smooth, protective shield for the drawer box.

Full Extension Drawer/Roll Tray Slides with Smart Stop™ Feature

Advanced, lifetime-guaranteed, zinc-coated steel drawer slides are manufactured of sturdy Class 1 cold rolled steel. Bottom mounting adds to strength, with the result being a drawer suspension system rated at 90 pounds capacity. Locking devices provide automatic latching, easy release for drawer removal and tool-free height adjustment. Quiet gliding permanently lubricated, synthetic rollers deliver a lifetime of smooth, trouble-free operation.

The drawer/roll tray system's Smart Stop feature adds an extra measure of convenience. The Smart Stop feature engages when the drawer/roll tray is 2" from closing. Resistance is applied to the self-closing mechanism, giving a gentle, controlled closing. Parallel-closing design ensures proper alignment.

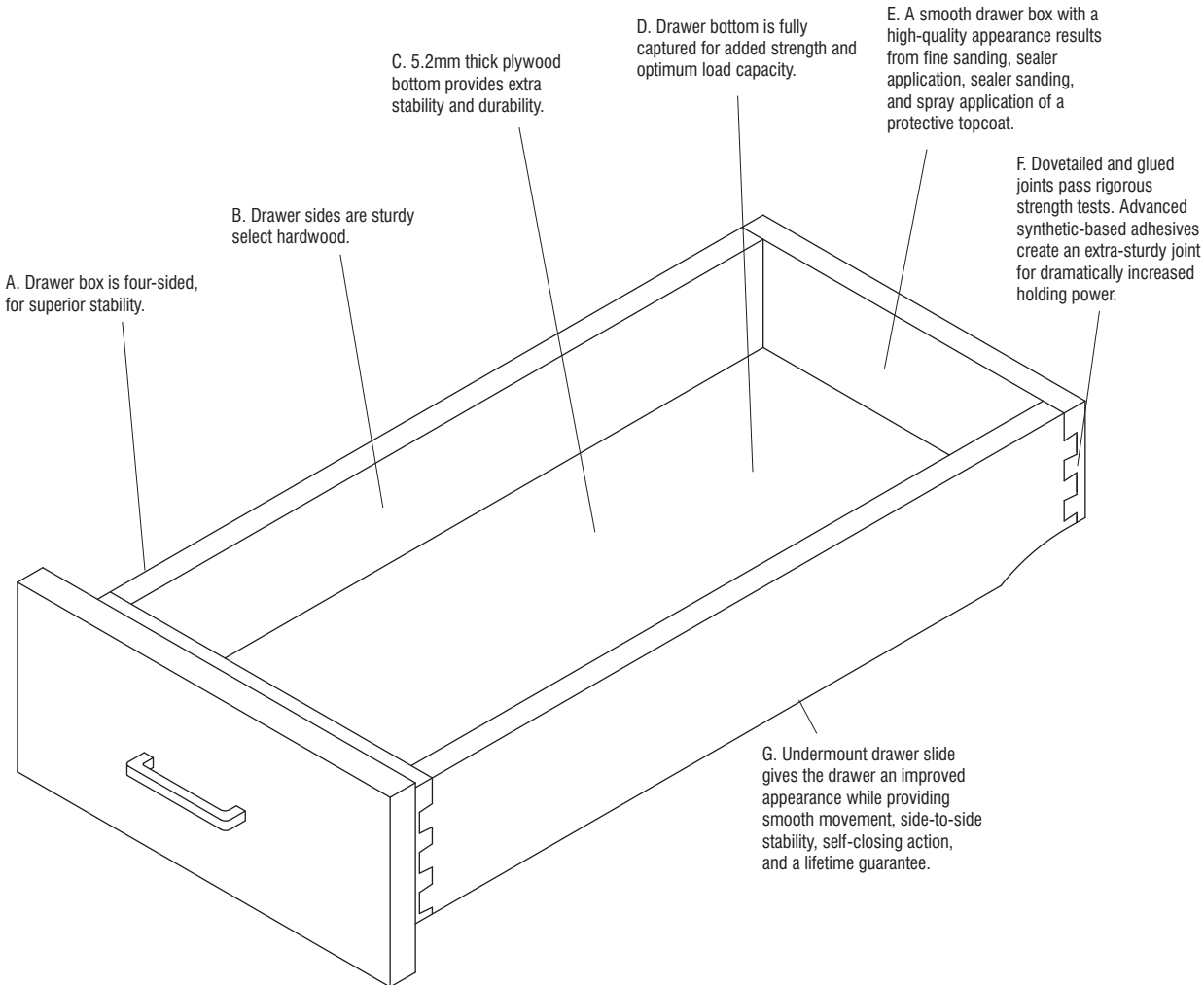

Inset and Beaded Inset Specifications

- Customers should be aware that Inset cabinetry is very different than standard overlay cabinetry, as it is not as tolerant or forgiving. Since the doors and drawer fronts are made to fit inside the frame with tight tolerances, inset cabinets are much more vulnerable to dimensional changes and racking than standard overlay cabinetry.
- Dimensional changes primarily occur when environmental conditions, such as temperature and humidity, are not controlled at an acceptable level. This causes the wood to expand and contract. This is something that cannot be avoided. It is very important that inset cabinets are never stored or installed in an environment where temperature and humidity reach extreme levels. Humidity levels should be kept between 30 to 55% for optimal results. Customers living in areas where these extremes cannot be controlled should avoid inset cabinets.
 - Too much humidity will cause the wood to expand, potentially leading to binding and nonfunctional doors/ drawers.
 - Too little humidity will cause the wood to contract, which could lead to larger gaps around the perimeter.
 - Doors / drawers that have been impacted by exposure to extreme environmental changes will usually return to their normal size over time once acceptable environmental levels have been implemented.
- If the style selected is inset, all standard 12" deep Wall cabinets will be converted to 13" deep at no upcharge. This additional depth makes up for the interior space lost by placing the door inside the face frame opening.
- Inset doors and drawers are manufactured with an approximate reveal of 3/32" on all sides. Changes in temperature and humidity may cause this gap to fluctuate over time. This is normal when using inset cabinets and should be expected.
- Designers suggest working with cabinets 15" wide or wider to ensure aesthetic balance throughout the kitchen. In cases where this is not possible, customers should be aware that cabinets less than 12" wide (9" opening) will use slab doors.
- Designers also suggest using one large cabinet versus multiple smaller cabinets to reduce the amount of visible face frame rails and seams. For example, the preference would be to use a W4530 instead of three W1530 L or R cabinets.
- Inset cabinets are available with standard concealed hinges or optional finial hinges. There are some noticeable differences between the two hinge types:
 - Concealed hinges are six-way adjustable (in/out, left/right, up/down). These hinges include the standard Smart Stop feature found on Diamond Edge's existing hinges. They allow for a 110-degree opening.
 - Finial hinges provide limited four-way adjustability (left/right, up/down), as they do not feature any in/out adjustment. These hinges do not include any type of Smart Stop feature (PDM add-ons are not available on Inset), therefore they swing freely when not held closed by the magnets. They offer a 180-degree opening. Finial hinges come in four colors: Antique Brass, Brushed Nickel, Matte Black, and Oil Rubbed Bronze.
- Finial hinges can only be used with Profile #12.
- The only valance available on beaded cabinets is the Straight valance. If the Arched, style B, style D, style E, style H, style J, style K, or style L are desired, it can be ordered as a loose accessory, but will not feature the beaded detail.
- When ordering Oven/Microwave cabinets in beaded inset, the cabinet should be ordered to the appropriate width using the 1/4" width modification instead of using piece-in or cut-out applications.
- Racking can occur if a cabinet is not installed properly. If the cabinet is installed out of square, it is possible to make the unit nonfunctional, as the doors and drawers will bind. Inset cabinets should be installed by experienced and patient installers. Inset cabinets require additional time to install and adjust components to the correct positioning.

Specifications & Dimensions

Wall Cabinet Dimensions (without doors)

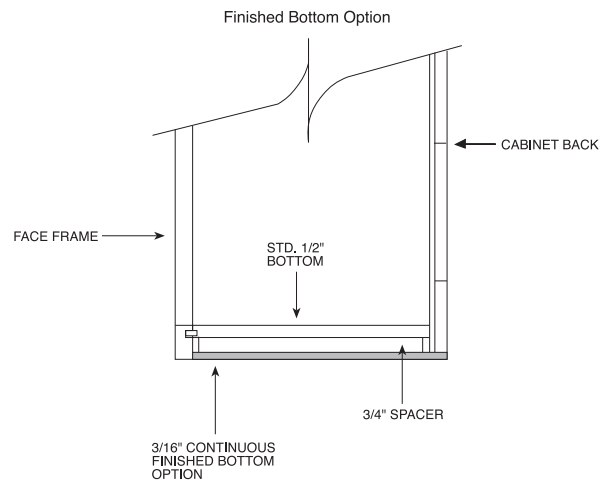
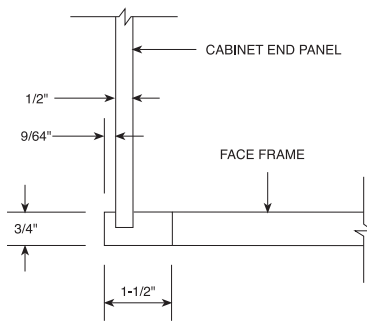
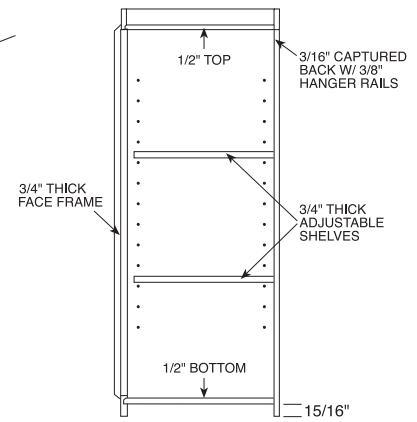
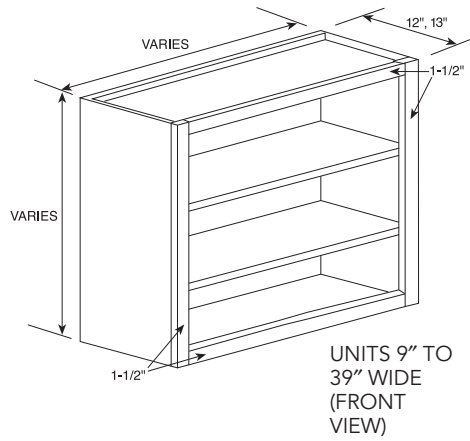
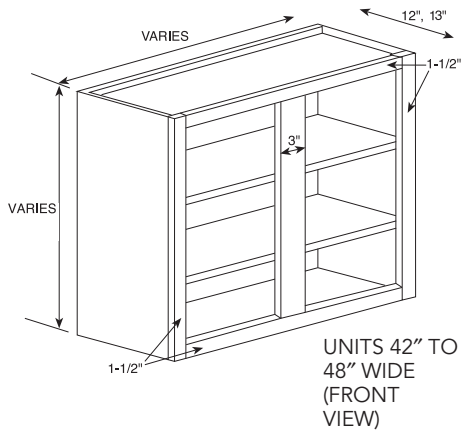

Base Cabinet Dimensions (without doors)

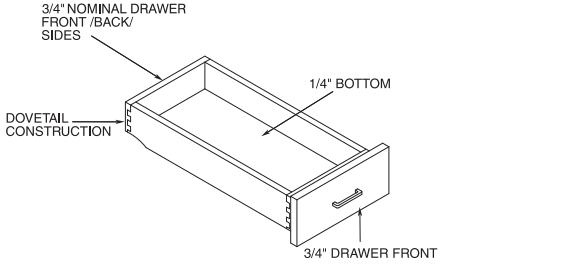
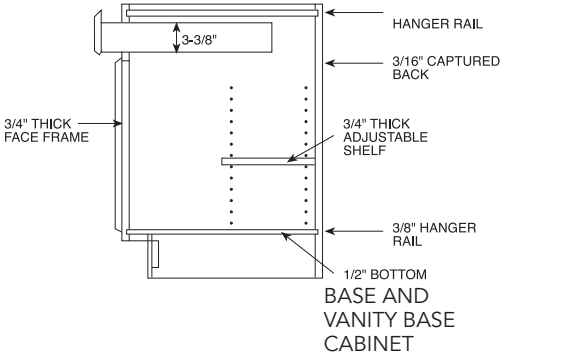
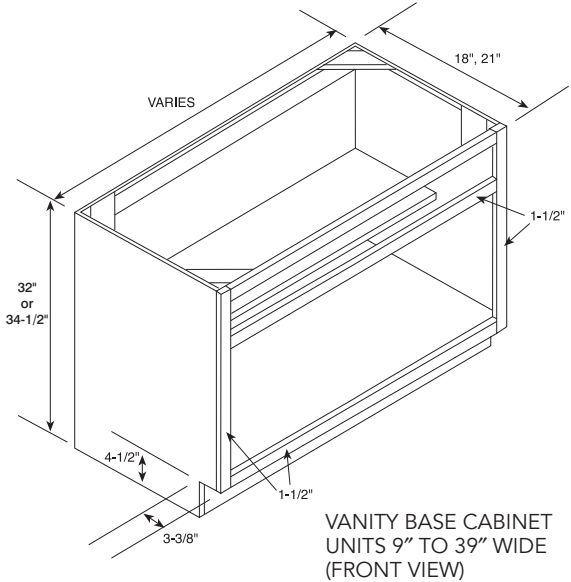
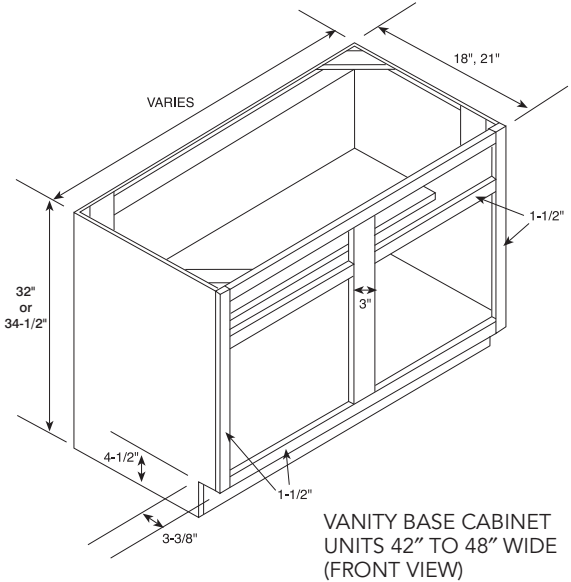
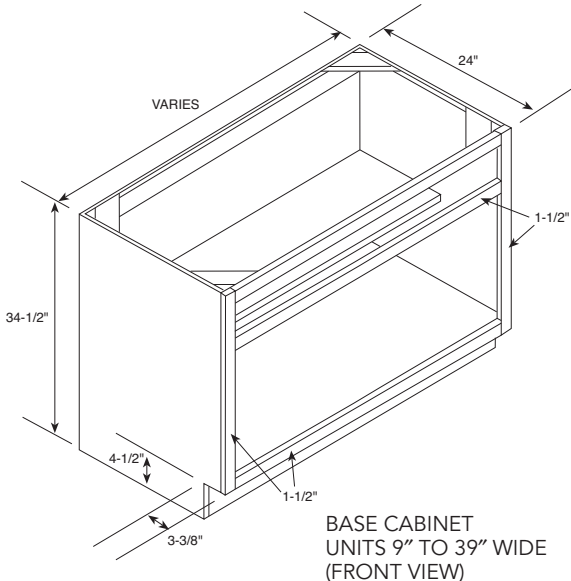
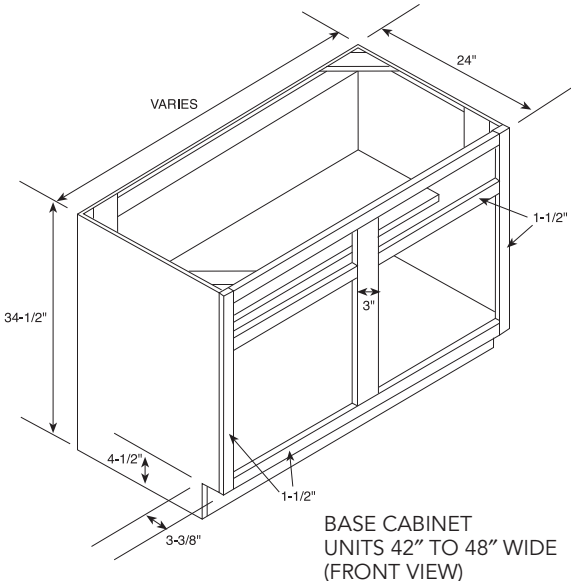

Specifications & Dimensions

Utility Cabinet Dimensions (without doors)

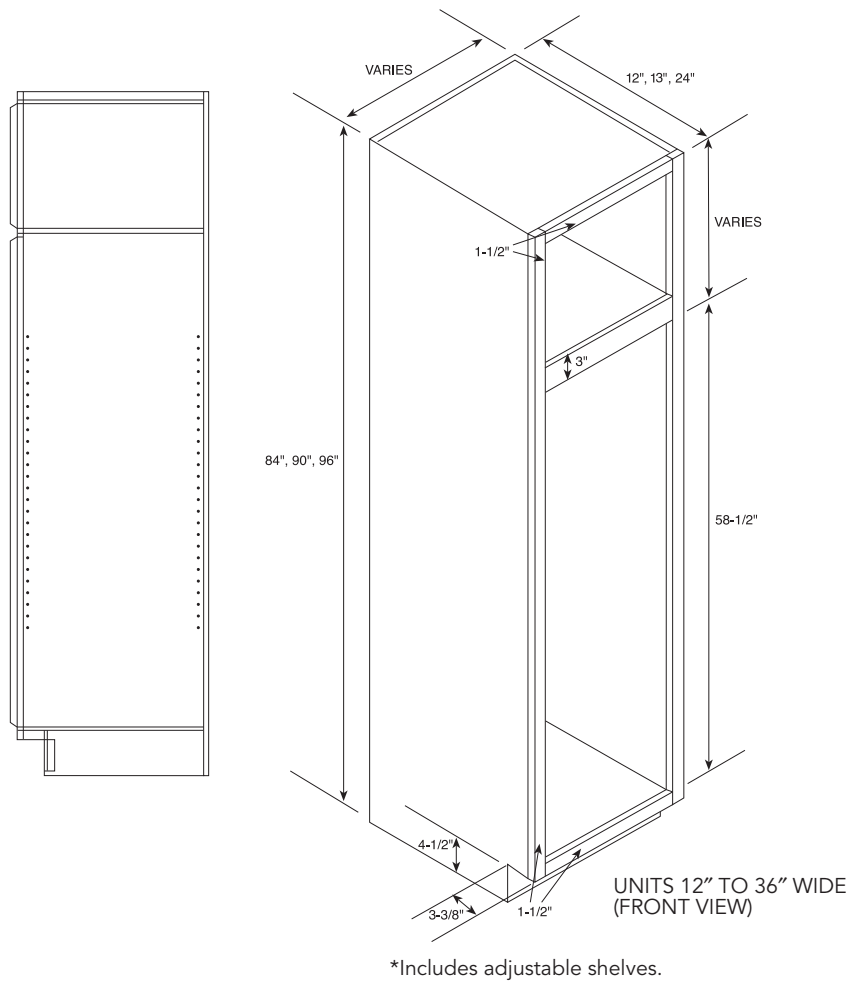

Cabinet Reveals

Reveals for Full Overlay Door Styles

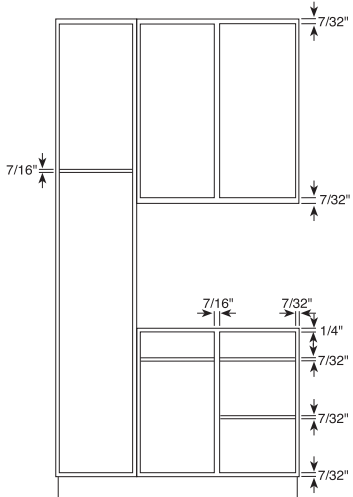

Shown is the amount of face frame that is exposed (revealed) with full overlay door styling.

- Reveal between butt door cabinets is 1/8".

Modified Full Overlay

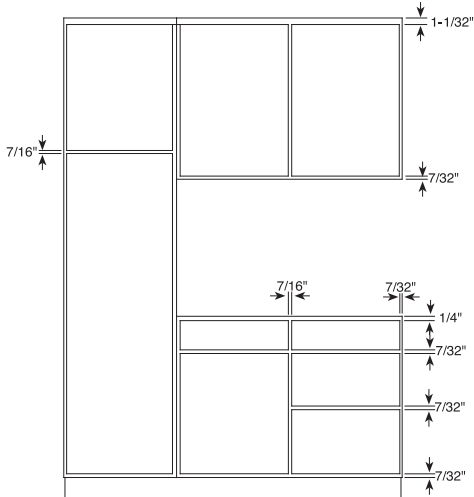

Shown is the amount of face frame that is exposed (revealed) with modified full overlay door styling.

- Reveal between butt door cabinets is 1/8".

Inset and Beaded Inset Doors

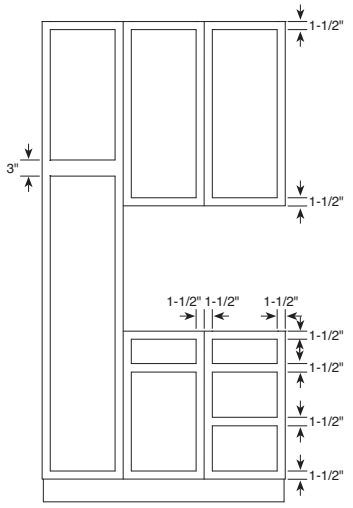

Shown is the amount of face frame that is exposed (revealed) with Inset and Beaded Inset door styling.

Specifications & Dimensions

Standard Opening Sizes

Wall Cabinets

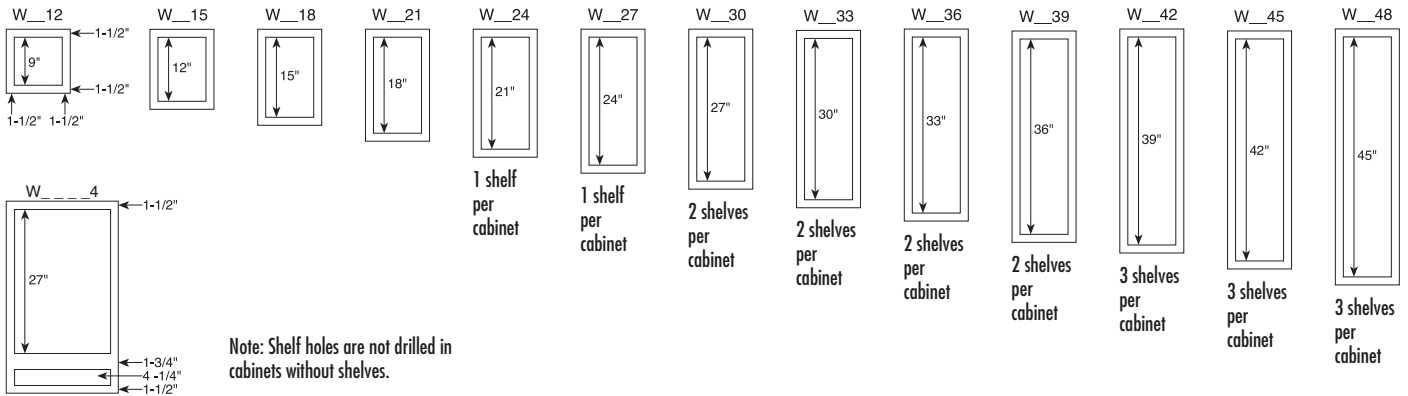

Base Cabinets

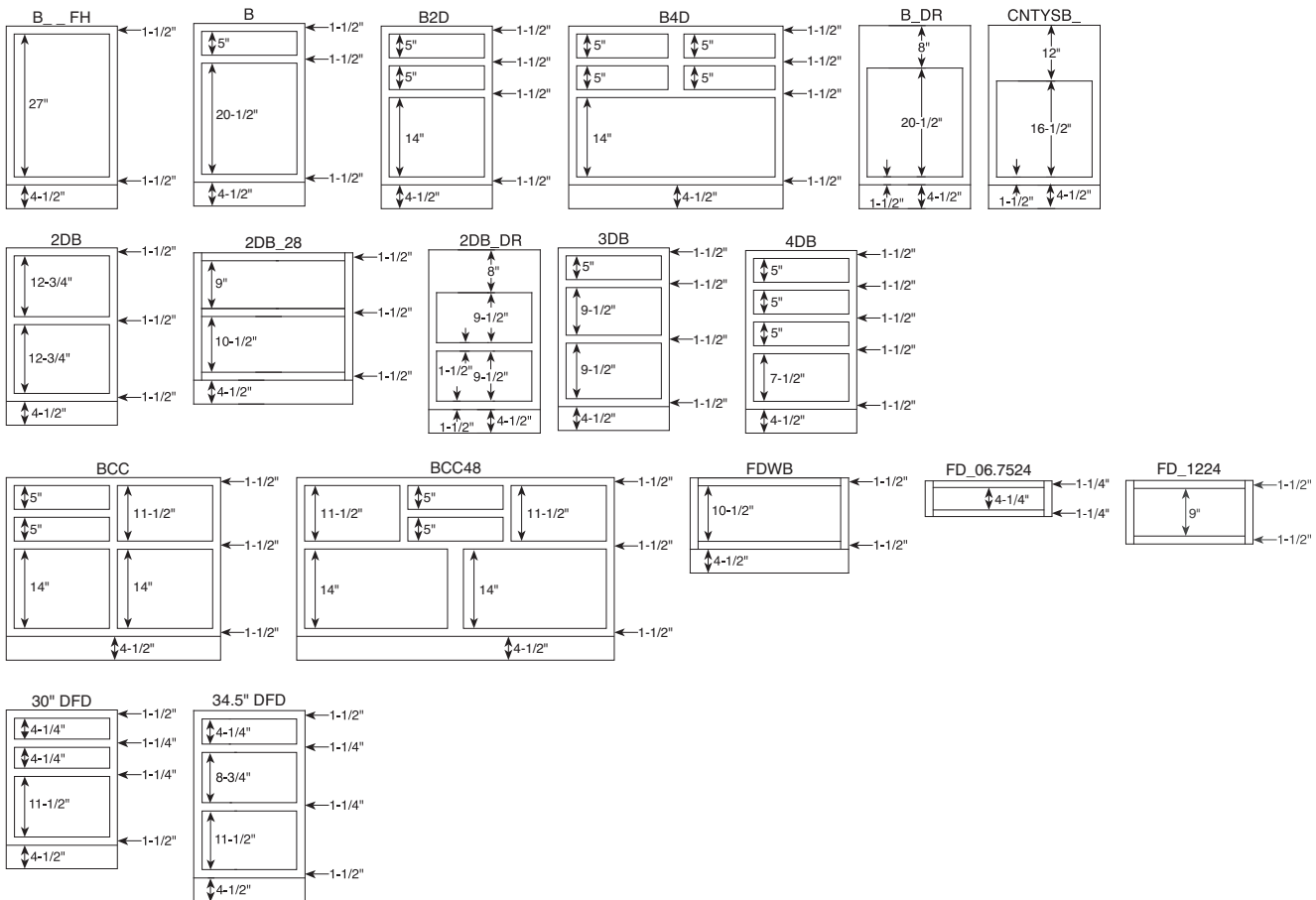

Standard Opening Sizes

Vanity Base Cabinets

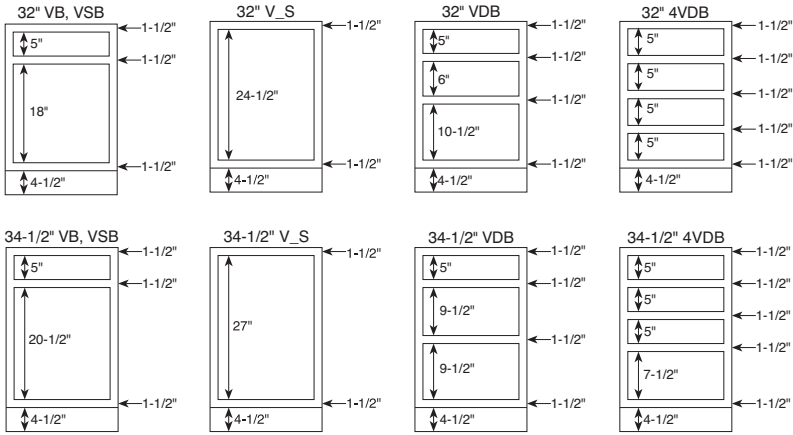

Bath Collection

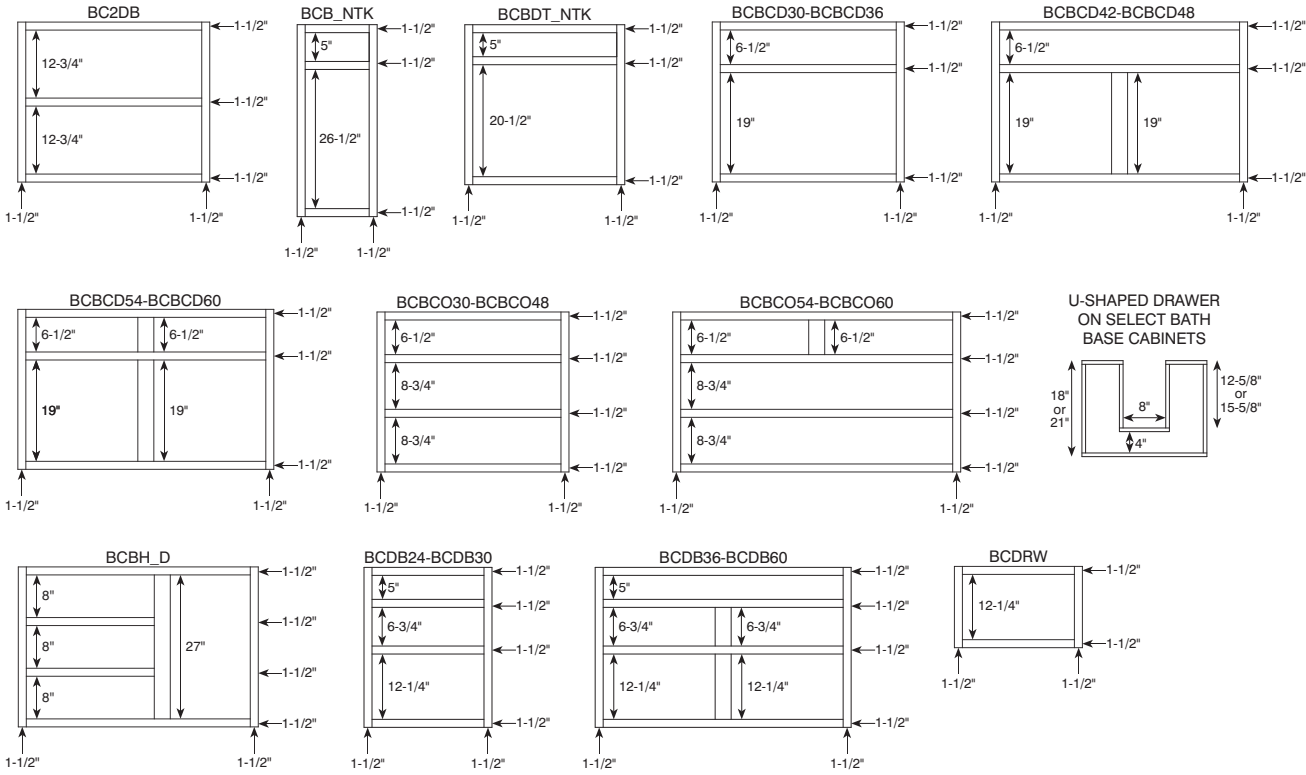

Specifications & Dimensions

Standard Opening Sizes

Bath Collection

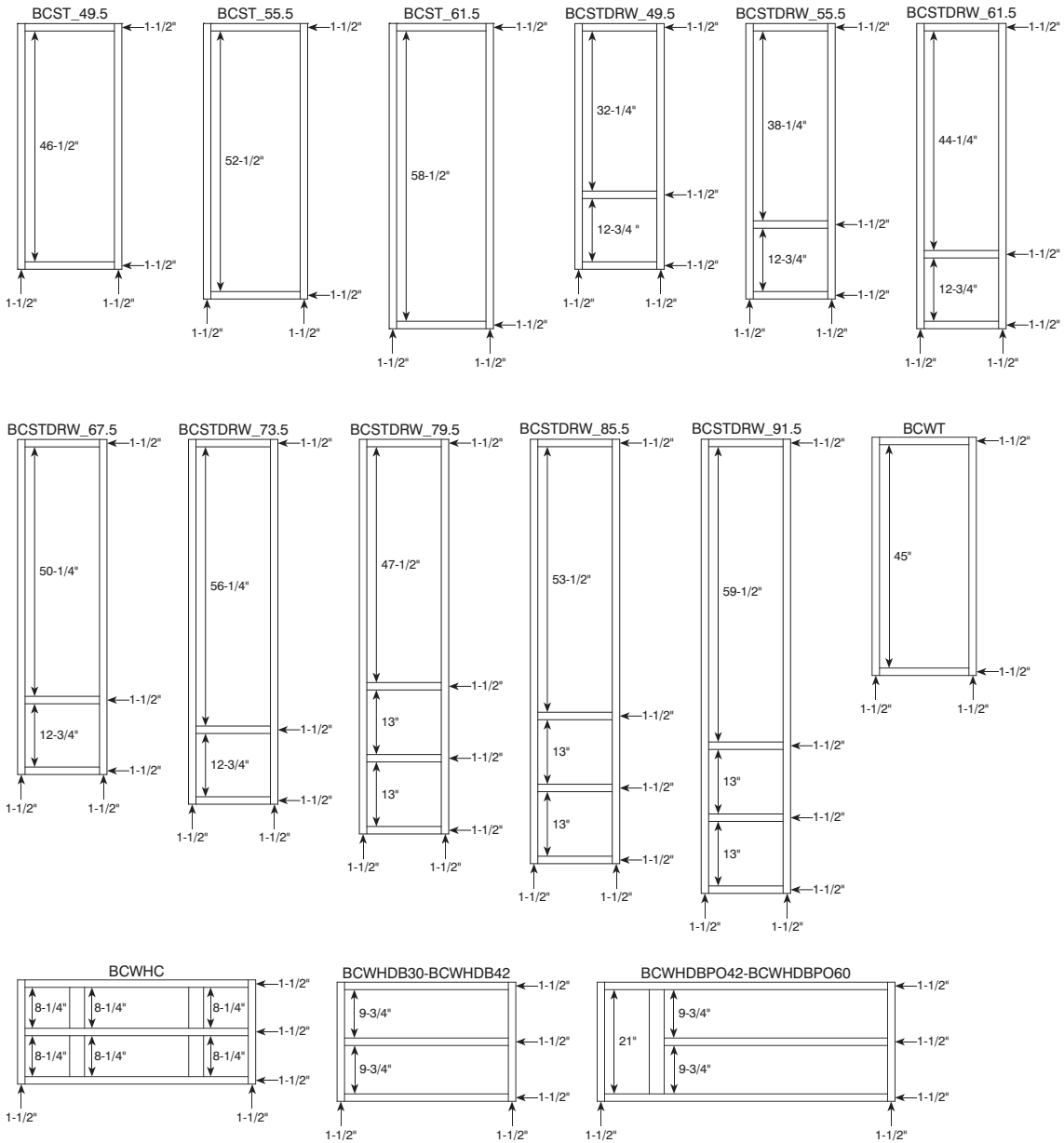

Standard Opening Sizes

Utility Cabinets

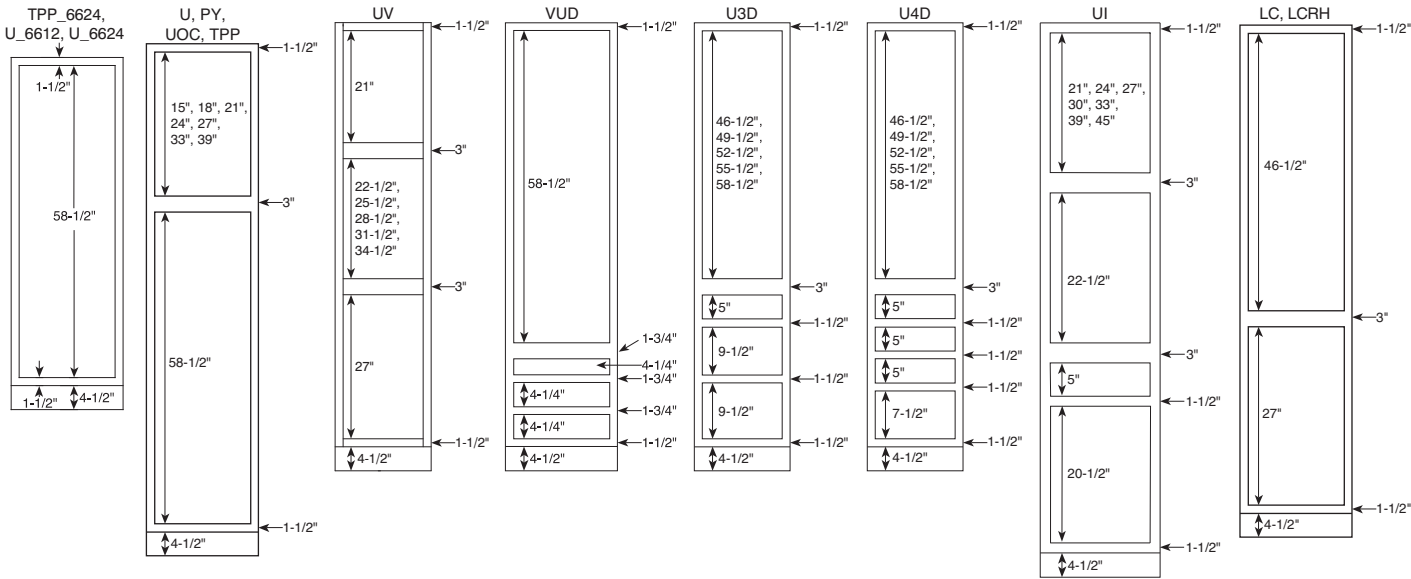

Hearth Cabinets

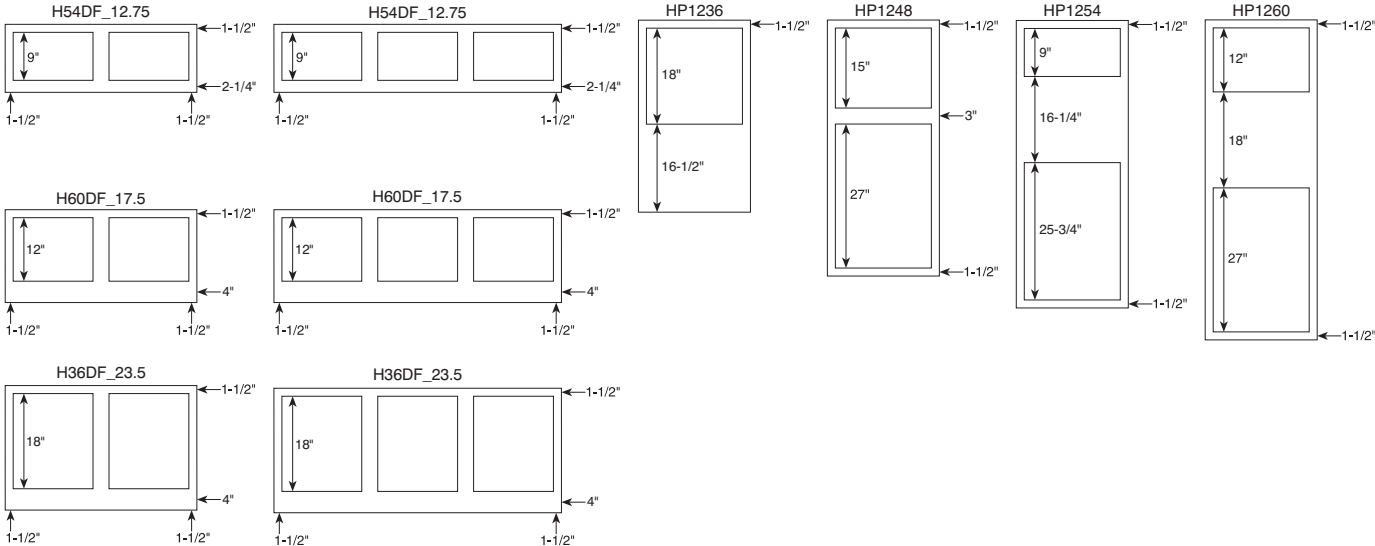

Specifications & Dimensions

Standard Opening Sizes

Entertainment Cabinets

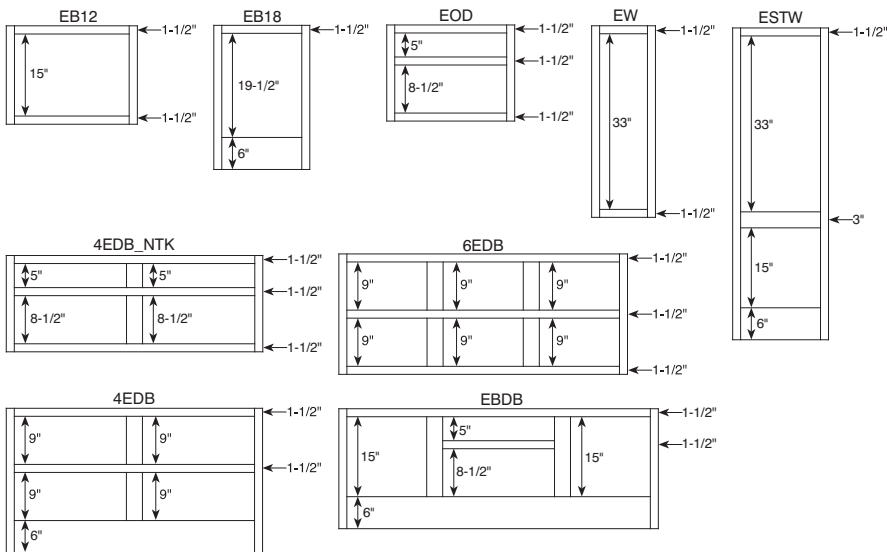

Home Office Cabinets

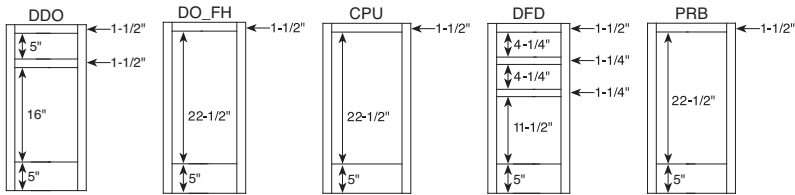

Standard Opening Sizes

Entry Ensembles

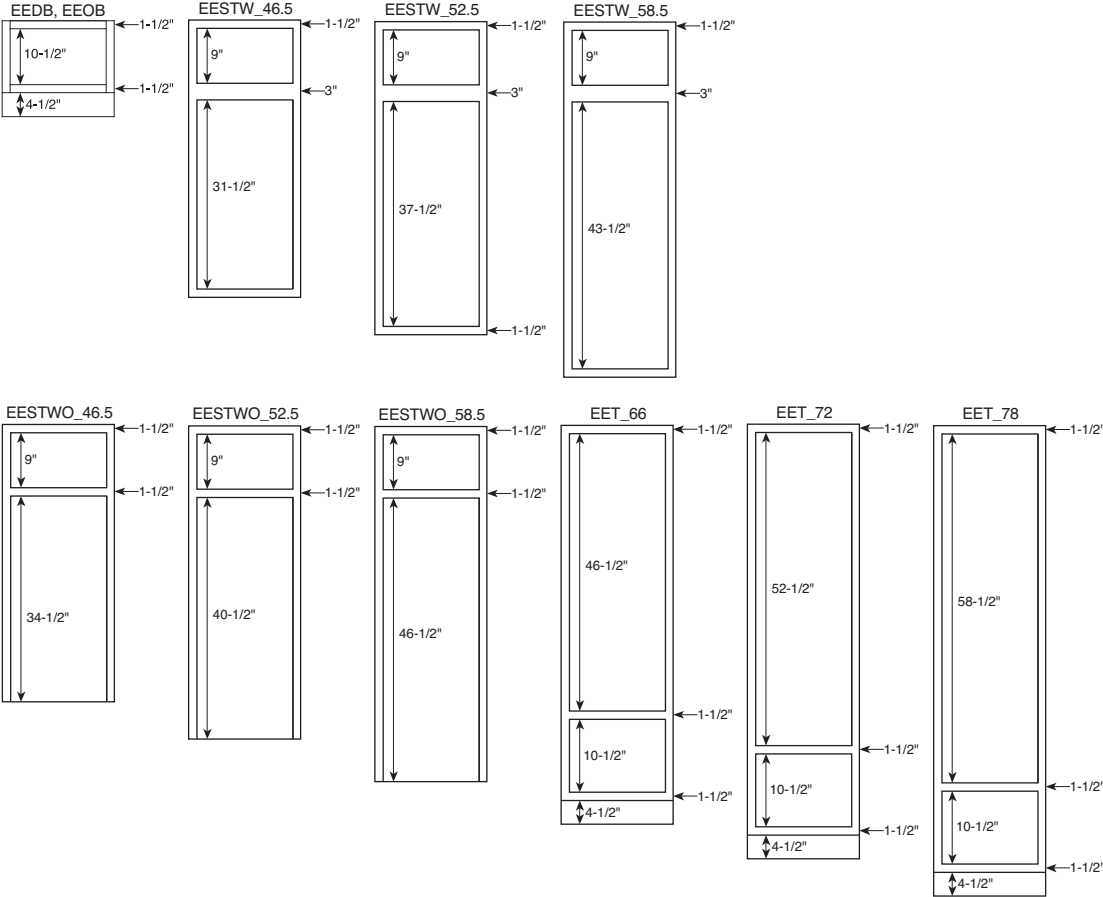

Specifications & Dimensions

Dimensions for Corner Installations (45° Diagonal)

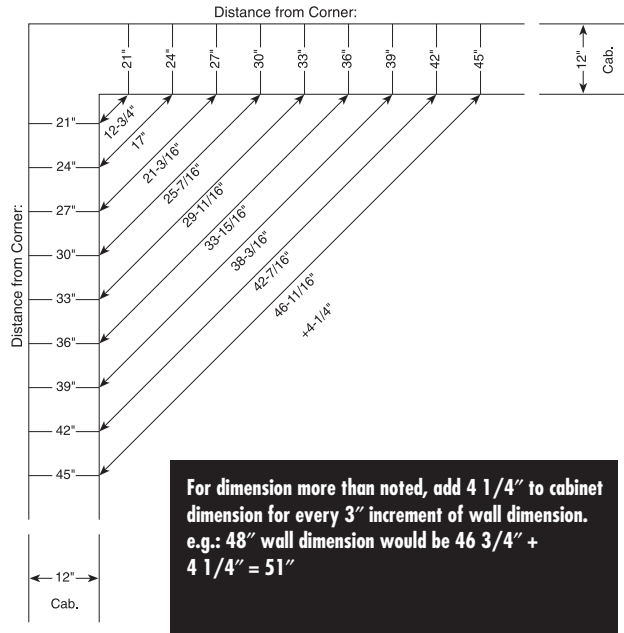
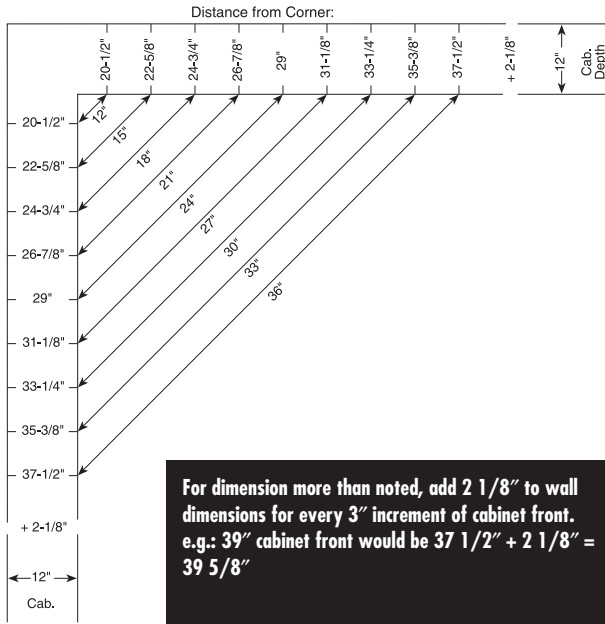

Wall Cabinets



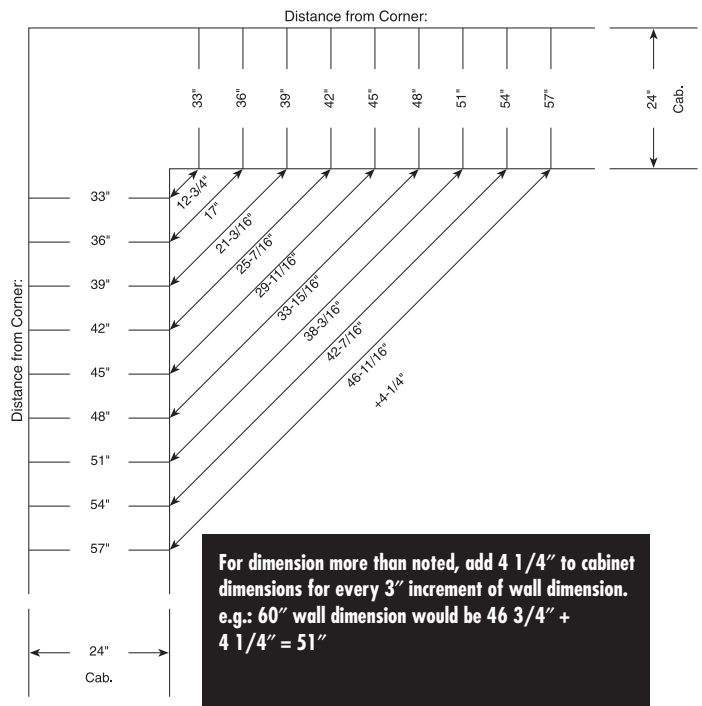
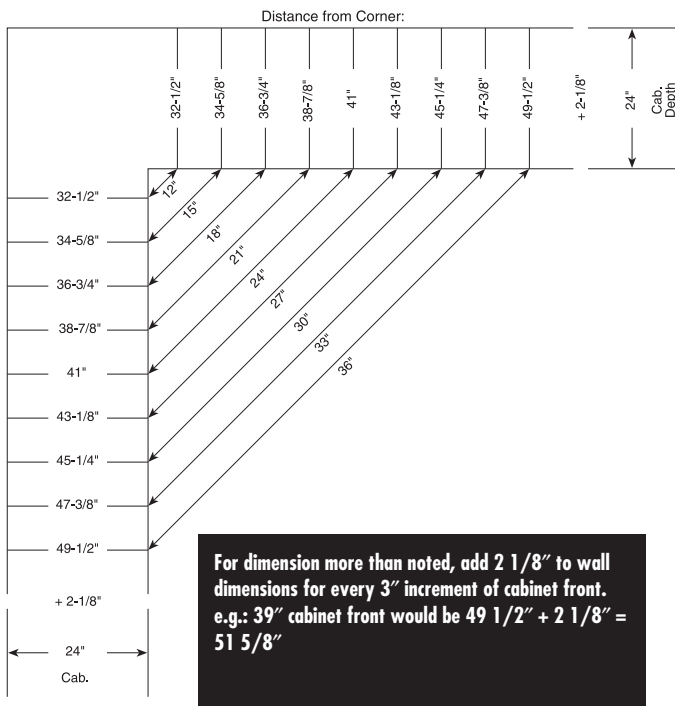





Base Cabinets













Modifications Quick Reference Sheet

Modification	Page	Code	Price					
			Wall	Base	Tall	Filler	Panel	
Add 1 Drawer Below Wall Unit	G•18	ADRW	280	N/A	N/A	N/A	N/A	(per cabinet)
Add 2 Drawers Below Wall Unit	G•18	A2DRW	540	N/A	N/A	N/A	N/A	(per cabinet)
Add 2 Drawers Below Wall Unit Increases Height by 18"	G•18	A2DRW18	540	N/A	N/A	N/A	N/A	(per cabinet)
Add 3 Drawers Below Wall Unit	G•18	A3DRW	820	N/A	N/A	N/A	N/A	(per cabinet)
Add Shelf	G•37	ADD_SHLF	80	140	N/A	N/A	N/A	(per shelf)
Add Toekick	G•29	ADDTK	0	N/A	N/A	N/A	N/A	(per cabinet)
Aluminum Door	G•14	Profile AF003, Profile AF006, Profile AF007	see Specialty Doors for details					
Attach Toekick	G•29	ATTK	N/A	N/A	0	N/A	N/A	(per cabinet)
Authentic Flush End	G•25	AUTHL, AUTHR	340	480	952	N/A	35%	(per end)
		AUTHB	340	480	952	N/A	N/A	(per end)
Automatic Opening Mechanism for Lift Up Systems	G•9	AOMD	3265	3265	3265	N/A	N/A	(per cabinet)
Automatic Opening Mechanism for Wastebaskets	G•9	AOMBWB	N/A	2245	N/A	N/A	N/A	(per cabinet)
Band All Edges	G•8	BND.ALL	N/A	N/A	N/A	0	0	(per part)
Banding Location	G•8	BND.FRT, BND.FRT.L, BND.FRT.R, BND.FRT.L.R, BND.FRT.BK	N/A	N/A	N/A	N/A	0	(per part)
Beaded Inset Door	G•12	BEADED	15%	15%	15%	N/A	N/A	(per cabinet)
Bottom Valance Rail	G•18	BVR_	165	N/A	N/A	25%	25%	(per cabinet)
Cabinet Box Only	G•19	CBO	-15%	-15%	15%	N/A	N/A	(per cabinet)
Cabinet Case Only	G•19	CCO	-15%	-15%	15%	N/A	N/A	(per cabinet)
Cabinet False Panel	G•31	CFP, CFPL, CFPR, CFPB	N/A	0	0	N/A	N/A	(per cabinet)
Cabinet Frame Only	G•20	CFRMO	-75%	-75%	-75%	N/A	N/A	(per cabinet)
Cabinet Front Only	G•20	CFNTO	-25%	-25%	-25%	N/A	N/A	(per cabinet)
Cabinet No Door	G•20	CND, CND.TOP, CND.MID, CND.BTM, CND.P	-15%	-15%	-15%	N/A	N/A	(per cabinet)
CabMat™ (Base)	G•37	CMAT1	N/A	300	N/A	N/A	N/A	(per cabinet)
CabMat™ (Vanity)	G•37	CMAT2	N/A	605	N/A	N/A	N/A	(per cabinet)
Car Siding Back	G•37	CSDGBK	280	280	410	N/A	N/A	(per cabinet)
Car Siding Flush Panel End	G•25	CSFPEL, CSFPER	140	200	410	N/A	35%	(per end)
Charging Drawer	G•38	CHGDRW, CHGDRWL, CHGDRWR	N/A	1250	N/A	N/A	N/A	(per cabinet)
		CHGDRWB	N/A	2500	N/A	N/A	N/A	(per cabinet)
3" Clipped Corner	G•20	CLIP3L, CLIP3R, etc.	410	480	540	N/A	N/A	(per side)
Craftsman Door	G•14	CCG, CCP, etc.	see Specialty Doors for details					
Cut-for-glass	G•14	CG	0	0	0	N/A	N/A	(per door)
Deep Roll Trays	G•31	DRT	N/A	140	140	N/A	N/A	(per roll tray)
Drawer Front Flat 5-piece	G•10	DFF5PC	60	60	60	N/A	N/A	(per drawer)
Drawer Front Flat 5-piece Inset	G•10	DFF5PCINS	60	60	60	N/A	N/A	(per drawer)
Drawer Front Flat 5-piece with Slab Top	G•10	DFF5PCSLBT	60	60	60	N/A	N/A	(per drawer)
Drawer Front Raised 5-piece	G•11	DFR5PC	60	60	60	N/A	N/A	(per drawer)
Drawer Front Raised 5-piece Inset	G•11	DFR5PCINS	60	60	60	N/A	N/A	(per drawer)
Drawer Front Raised 5-piece with Slab Top	G•11	DFR5PCSLBT	60	60	60	N/A	N/A	(per drawer)
Drawer Front Slab	G•11	DFS LB	0	0	0	N/A	N/A	(per drawer)
Drawer Front Slab Top	G•12	DFS LBT	0	0	0	N/A	N/A	(per drawer)
End Extended Back	G•25	EXBKL, EXBKR	140	170	200	N/A	N/A	(per end)
Extended Stile with Overlay	G•20	EXLXL, EXROL, EXBOL, EXLXL.P, EXROL.P, EXBOL.P	0	0	0	N/A	0	(per stile)
Extended Stiles	G•21	EXL, EXR, EXL.P, EXR.P	0	0	0	N/A	N/A	(per stile)
Face Frame and Door on End	G•26	FFDL, FFDR, etc.	280	410	680	N/A	N/A	(per end)
Finished Blind	G•21	FBFL, FBFR	140	140	N/A	N/A	N/A	(per cabinet)
Finished Bottom	G•8	PFINBTMB	140	N/A	N/A	N/A	N/A	(per cabinet)
Finished Edges	G•8	F.FRT, F.FRT.L, F.FRT.R, F.FRT.L.R, F.FRT.BK	N/A	N/A	N/A	0	0	(per part)
Finished Edges – All	G•8	F.ALL	N/A	N/A	N/A	10%	10%	(per part)
Finished Ends	G•8	FL, FR	95	155	395	N/A	N/A	(per end)
Flush Panel End	G•26	FPEL, FPER	140	170	280	N/A	280	(per end)
Flush Toekick	G•21	FTK, FTK.P	0	0	0	0	0	(per cabinet)
Flush Toekick – Arch	G•21	FTKAV, FTKAV.P	0	0	0	0	0	(per cabinet)
Flush Toekick – Style B 	G•21	FTKB, FTKB.P	0	0	0	0	0	(per cabinet)
Flush Toekick – Style D 	G•21	FTKD, FTKD.P	0	0	0	0	0	(per cabinet)

Custom Modifications

Modification	Page	Code	Price						
			Wall	Base	Tall	Filler	Panel		
Flush Toekick — Style E 	G•21	FTKE, FTKE.P	0	0	0	0	0	(per cabinet)	
Flush Toekick — Style H 	G•21	FTKH, FTKH.P	0	0	0	0	0	(per cabinet)	
Flush Toekick — Style J 	G•21	FTKJ, FTKJ.P	0	0	0	0	0	(per cabinet)	
Flush Toekick — Style K 	G•21	FTKK, FTKK.P	0	0	0	0	0	(per cabinet)	
Flush Toekick — Style L 	G•21	FTKL, FTKL.P	0	0	0	0	0	(per cabinet)	
Fluting — 3" parts	G•38	FLUT3L, FLUT3R, FLUT3B, etc.	50	50	50	N/A	N/A	(per part)	
Fluting — 6" parts	G•38	FLUT6L, FLUT6R, FLUT6B, etc.	50	50	50	N/A	N/A	(per part)	
Fluting on Fillers — 3" parts	G•39	FLUT3	N/A	N/A	N/A	50	50	(per part)	
Fluting on Fillers — 6" parts	G•39	FLUT6, FLUT3CTR	N/A	N/A	N/A	95	95	(per part)	
Full Depth Shelf	G•39	FD	N/A	50	N/A	N/A	N/A	(per cabinet)	
Gallery Mullion Door	G•14	GAMD, GAMD.TOP, GAMD.MID, GAMD.BTM, GAMD.P	see Specialty Doors for details						
Horizon Door	G•15	HCG, HCGCP, HCP, etc.	see Specialty Doors for details						
Increased Depths	G•39	ID	0	0	0	N/A	0	(per cabinet)	
Increased Heights	G•40	IH	0	0	N/A	0	0	(per cabinet)	
Increased Widths	G•48	IW	0	0	0	N/A	N/A	(per cabinet)	
Increased Widths in 1/4" Increments	G•46	IW . . .	0	0	0	0	0	(per cabinet)	
Inset Door	G•12	NOBEAD	15%	15%	15%	N/A	N/A	(per cabinet)	
Inset Finial Hinges	G•12	IFAB, IFBN, IFMB, IFORB	0	0	0	N/A	N/A	(per hinge)	
Inset Panel Ends	G•27	IPEL, IPER	410	540	680	N/A	680	(per end)	
Integral End	G•28	INTGEL, INTGER	410	540	680	N/A	680	(per end)	
Inverted Frame	G•21	INVFRM	0	0	N/A	N/A	N/A	(per cabinet)	
L-shaped Organizer	G•50	VLSOL, VLSOR	N/A	700	N/A	N/A	N/A	(per cabinet)	
		VLSOB	N/A	1400	N/A	N/A	N/A	(per cabinet)	
Matching Interior	G•9	MIP	25%	25%	25%	N/A	N/A	(per cabinet)	
Mission Door	G•15	MCG, MCGCP, MCP, etc.	see Specialty Doors for details						
Modified Full Overlay	G•13	MFO	0	N/A	0	N/A	N/A	(per cabinet)	
Moulding Location	G•36	MLDG	N/A	0	N/A	N/A	N/A	(per part)	
Mullion Doors	G•16	MD, MD.TOP, MD.MID, MD.BTM, MD.P	see Specialty Doors for details						
Nickel Towel Bar	G•24	TBN	140	N/A	N/A	N/A	N/A	(per part)	
No Hinge Cut	G•16	NHC	0	0	0	N/A	N/A	(per door)	
Open Bottom Rail Base	G•22	OBRB, OBRB.P	0	0	0	N/A	N/A	(per cabinet)	
Prairie Mullion Doors	G•16	PRMD, PRMD.TOP, PRMD.MID, PRMD.BTM, PRMD.P	see Specialty Doors for details						
Profiled and Finished Edges	G•9	PRO.FRT, PRO.FRT.BK, PRO.FRT.L, PRO.FRT.R, PRO.FRT.LR, PRO.FRT.LBK, PRO.FRT.RBK, PRO.LR	N/A	N/A	N/A	0	0	(per part)	
Profiled and Finished Edges — All	G•9	PRO.ALL	N/A	N/A	N/A	15%	15%	(per part)	
Push-to-Open Wastebasket	G•13	PTOWB	N/A	525	N/A	N/A	N/A	(per cabinet)	
Recessed Toekick	G•29	RECTKL, RECTKR, RECTKBK, etc.	0	0	0	N/A	N/A	(per side)	
Recessed Toekick — 6" 	G•29	RECTKL6, RECTKR6, RECTKBK6	N/A	166	N/A	N/A	N/A	(per cabinet)	
		RECTKL.R6, RECTKL.BK6, RECTKR.BK6, RECTKFRT.BK6, RECTKFRT.L6, RECTKFRT.R6	N/A	330	N/A	N/A	N/A	(per cabinet)	
		RECTKL.R.BK6, RECTKFRT.L.R6, RECTKFRT.L.BK6, RECTKFRT.R.BK6	N/A	495	N/A	N/A	N/A	(per cabinet)	
		RECTKALL6	N/A	666	N/A	N/A	N/A	(per cabinet)	
Recessed Toekick Front	G•30	RECTKFRT	N/A	N/A	0	N/A	N/A	(per cabinet)	
Recessed Toekick Front — 6" 	G•30	RECTKFRT6	N/A	166	N/A	N/A	N/A	(per cabinet)	
Recessed Vanity Wall	G•22	REC	15%	N/A	N/A	N/A	N/A	(per cabinet)	
Reduced Depths	G•39	RD	0	0	0	N/A	0	(per cabinet)	
Reduced Heights	G•40	RH	0	0	N/A	0	0	(per cabinet)	
Reduced Widths	G•49	RW	0	0	0	0	N/A	(per cabinet)	
Roll Tray Bottom with Full Depth Shelf (12" to 39")	G•31	FDSRTBTM	N/A	325	N/A	N/A	N/A	(per cabinet)	
Roll Tray Bottom with Full Depth Shelf (39 1/4" to 48")	G•31	FDSRTBTM	N/A	650	N/A	N/A	N/A	(per cabinet)	
Roll Trays (12" to 24")	G•32	_RT, _RTL, _RTR, etc.	265	265	265	N/A	N/A	(per roll tray)	
Roll Trays (27" to 36")	G•32	_RT, _RTL, _RTR, etc.	325	325	325	N/A	N/A	(per roll tray)	
Rose Fluting — 3" parts	G•50	ROSLUT3L, ROSFLUT3R, ROSFLUT3B, etc.	50	50	50	N/A	N/A	(per part)	
Rose Fluting on Fillers — 3" parts	G•50	ROSLUT3	N/A	N/A	N/A	50	50	(per part)	
Rose Fluting on Fillers — 6" parts	G•50	ROSLUT3CTR	N/A	N/A	N/A	95	95	(per part)	

Modification	Page	Code	Price					
			Wall	Base	Tall	Filler	Panel	
Scooped Drawer	G•32	SCPDRW, SCPDRWL, SCPDRWR	N/A	60	N/A	N/A	N/A	(per drawer)
		SCPDRWB	N/A	60	N/A	N/A	N/A	(per drawer)
Scooped Roll Tray 	G•32	SRT	N/A	5%	5%	N/A	N/A	(per cabinet)
Secured Drawer featuring Master Lock Biometric Technology 	G•51	DRWSEC, DRWSECL, DRWSECR	N/A	590	N/A	N/A	N/A	(per cabinet)
		DRWSECB	N/A	1180	N/A	N/A	N/A	(per cabinet)
Shaker Mullion Door	G•16	SHMD, SHMD.TOP, SHMD.MID, SHMD.BTM, SHMD.P	see Specialty Doors for details					
Single Panel Tall Door 	G•13	SGLPN	N/A	N/A	0	N/A	N/A	(per door)
Sink Base Cleaning Caddy	G•51	SBCADDYL, SBCADDYR	N/A	1225	N/A	N/A	N/A	(per cabinet)
Sink Base Cleaning Caddy Small	G•51	SBCADDYSML, SBCADDYSMR	N/A	950	N/A	N/A	N/A	(per cabinet)
Split Doors	G•13	SPLITDR, SPLITDR.LL, SPLITDR.RR, SPLITDR.P, SPLITDR.LL.P, SPLITDR.RR.P	0	0	0	N/A	N/A	(per cabinet)
Split Drawers	G•13	SPLITDRWS	N/A	0	0	N/A	N/A	(per cabinet)
Stacked Wall Cabinet Heights	G•22	STW.TOP_, STW.BTM_	0	N/A	N/A	N/A	N/A	(per cabinet)
Storage Open Rail Base	G•22	STORB	N/A	100	100	N/A	N/A	(per cabinet)
Toekick Drawer	G•30	DRWTK	N/A	720	720	N/A	N/A	(per cabinet)
Toekick Pedestal	G•30	TKP	0	0	0	N/A	N/A	(per cabinet)
Top Valance Rail — Arch	G•23	TVRAV, TVRAVBTM, TVRAVMID, TVRAVTOP, TVRAV.P	0	0	0	N/A	N/A	(per cabinet)
Top Valance Rail — Straight	G•23	TVRVV, TVRVVBTM, TVRVVMID, TVRVVTOP, TVRVV.P	0	0	0	N/A	N/A	(per cabinet)
Top Valance Rail — Style B 	G•23	TVRB, TVRBTOP, TVRBMID, TVRBBTM, TVRB.P	0	0	0	N/A	N/A	(per cabinet)
Top Valance Rail — Style D 	G•23	TVRD, TVRDTOP, TVRDMID, TVRDBTM, TVRD.P	0	0	0	N/A	N/A	(per cabinet)
Top Valance Rail — Style E 	G•23	TVRE, TVRETOP, TVRE MID, TVREBTM, TVRE.P	0	0	0	N/A	N/A	(per cabinet)
Top Valance Rail — Style H 	G•23	TVRH, TVRHTOP, TVRH MID, TVRHBTM, TVRH.P	0	0	0	N/A	N/A	(per cabinet)
Top Valance Rail — Style J 	G•23	TVRJ, TVRJTOP, TVRJMID, TVRJBTM, TVRJ.P	0	0	0	N/A	N/A	(per cabinet)
Top Valance Rail — Style K 	G•23	TVRK, TVRKTOP, TVRKMID, TVRKBTM, TVRK.P	0	0	0	N/A	N/A	(per cabinet)
Top Valance Rail — Style L 	G•23	TVRL, TVRLTOP, TVRLMID, TVRLBTM, TVRL.P	0	0	0	N/A	N/A	(per cabinet)
Transom Doors — Center Panel	G•17	TCP, TCPCG, TCP.TOP, TCPCG.TOP, TCP.P, TCPCG.P	140	N/A	N/A	N/A	N/A	(per door)
Transom Doors — Cut-for-glass	G•17	TCG, TCGCG, TCG.TOP, TCGCG.TOP, TCG.P, TCGCG.P	140	N/A	N/A	N/A	N/A	(per door)
Tray Divider	G•52	_TD, etc.	140	140	140	N/A	N/A	(per divider)
U-shaped Drawer Box	G•33	UDBX, UDBXL, UDBXR, UDBXB, UDBX1, UDBX2, UDBX1L, UDBX2L, UDBX1R, UDBX2R, UDBX1B, UDBX2B, UDBX3, UDBX4	N/A	85	85	N/A	N/A	(per drawer box)
U-shaped Roll Tray	G•34	URT, URTL, URTR, URTB	N/A	85	85	N/A	N/A	(per roll tray)
		URT_	N/A	355	355	N/A	N/A	(per roll tray)
Vanity Wastebasket Container	G•52	VWBL, VWBR	N/A	1200	N/A	N/A	N/A	(per cabinet)
Void Toekick	G•30	VTK	N/A	0	0	N/A	N/A	(per cabinet)
Wall End and Back Extended Down	G•28	EXDNL, EXDNR, EXDNLRB	140	N/A	N/A	N/A	N/A	(per end)
Wide Stiles	G•24	WSL1.5, WSR1.5, WSL3, WSR3, WSB1.5, WSB3	60	60	60	N/A	N/A	(per side)
Wide Top Rail	G•24	WTR	60	60	60	60	60	(per cabinet)
Wood Tiered Cutlery Divider Drawer	G•52	WTCB, WTCDL, WTCDR	N/A	430	430	N/A	N/A	(per cabinet)
		WTCDB	N/A	850	850	N/A	N/A	(per cabinet)
Wood Tiered K-Cup Drawer	G•52	WTKCUP, WTKCUPL, WTKCUPR	N/A	670	670	N/A	N/A	(per cabinet)
		WTKCUPB	N/A	1340	1340	N/A	N/A	(per cabinet)
3" Wood Top Clipped Corner	G•35	WTCLIP3L, WTCLIP3R, WTCLIP3B, WTCLIP3LFRT.LBK, WTCLIP3RFRT.RBK	30	30	N/A	N/A	N/A	(per side)
6" Wood Top Clipped Corner	G•35	WTCLIP6L, WTCLIP6R, WTCLIP6B, WTCLIP6LFRT.LBK, WTCLIP6RFRT.RBK	30	30	N/A	N/A	N/A	(per side)

Custom Modifications

Finish Modifications

Band All Edges

Wall	Base	Tall	Filler	Panel	
N/A	N/A	N/A	0	0	per part

Specify BND.ALL (Band All Edges)

- Available on:
 - SHELFMI, SHELFNAT, 1/2NAT2S, 3/4NAT2S, 3/4VEN2S, and 1/2VEN2S. See filler and panel section for more detail.

Banding Location

Wall	Base	Tall	Filler	Panel	
N/A	N/A	N/A	N/A	0	per part

Specify BND.FRT (Band Front), BND.FRT.L (Band Front & Left), BND.FRT.R (Band Front & Right), BND.FRT.L.R (Band Front, Left & Right), BND.FRT.BK (Band Front & Back)

- Available on:
 - SHELFMI and SHELFNAT. See filler and panel section for more detail.

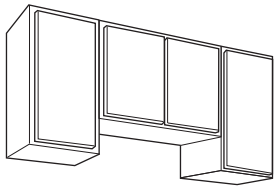

Finished Bottom

Wall	Base	Tall	Filler	Panel	
140	N/A	N/A	N/A	N/A	per cabinet

Specify PFINBTMB (Finished Bottom)

Wall cabinets can be ordered with this option, which provides an attractive uniform appearance for the bottom of a run of wall cabinets. Cabinets are prepared with pre-installed spacer blocks.

- The designer must order a 3/16VENTS to fit the run of the cabinets which will need to be attached by the installer.
- The designer will need to add the correct number of panels required for all depths of Finished Bottom cabinets on the order.
- Additional blocking in field may be required when ordered in conjunction with BVR_ options.
- For use with Diagonal Wall & Diagonal Wall Peninsula Wall Cabinets, Wall Refrigerator Cabinets, and straight cabinet runs (different depths can be ordered in a cabinet run, but a different 3/16VENTS will need to be ordered for each depth).
 - Finished Bottom Diagonal Wall Dimensions: 24" W x 24" D
 - Finished Bottom Diagonal Wall Peninsula Dimensions: 27" W x 27" D
 - Finished Bottom Wall Refrigerator Dimensions: 23 1/4" W x 48" D
 - Straight Cabinet Run Finished Bottom Dimensions: W (Cabinet Depth - 3/4") x 96" D
- Not available on:
 - Flush Toekick - Arch, Add Drawer, Flush Toekick - Style B, Flush Toekick - Style D, Flush Toekick - Style E, Flush Toekick - Style H, Flush Toekick - Style J, Flush Toekick - Style K, and Flush Toekick - Style L.



Finished Front, Left and Right Shown

Finished Edges

Wall	Base	Tall	Filler	Panel	
N/A	N/A	N/A	0	0	per part
N/A	N/A	N/A	10%	10%	per part

Specify F.FRT (Finished Front), F.FRT.L (Finished Front and Left), F.FRT.R (Finished Front and Right), F.FRT.L.R (Finished Front, Left and Right), F.FRT.BK (Finished Front and Back), or F.ALL (Finished All Edges)

With this option, the finished edge selected on the order will be applied to the specified sides.

- Finished All Edges (F.ALL) is available on all mouldings but the two ends are not finished.
- Available on:
 - 3/4SOLID and SHELFSLD material. See page Q•22.

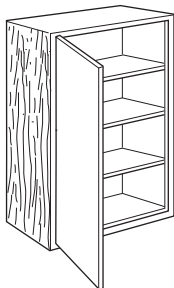

Finished Ends

Wall	Base	Tall	Filler	Panel	
95	155	395	N/A	N/A	per end

Specify FL (Finished End Left) or FR (Finished End Right)

Finished Ends should be specified on any cabinet end that will be exposed after installation.

- Finished Ends standard on:
 - Authentic End, Flush Panel End, Car Siding Flush Panel End, or Face Frame and Door on End.

Finish Modifications (cont'd)

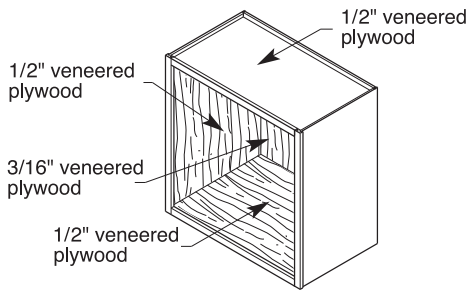

Matching Interior

Specify MIP (Matching Interior)

With this option, the cabinet interior is stained to match the exterior of the cabinet. The cabinet shelf, top and bottom exteriors are also stained to match with this option.

- Pull-out options such as drawer boxes, roll trays, swing-outs, etc., remain in the Natural wood color.
- On all cabinets with a white painted finish, Matching Interior (MIP) option must be used if white interior finish is desired.
- When a decorative door option is chosen in 20/20, Matching Interior Plywood (MIP) is a preselected option. If MIP is not desired, it can be deselected by choosing NOTMIP.
- Cabinets ordered with matching interiors feature 3/4" wood veneered shelves.
- See individual cabinets for details.

Wall	Base	Tall	Filler	Panel	
25%	25%	25%	N/A	N/A	per cabinet



Profiled and Finished Front, Left and Right Shown

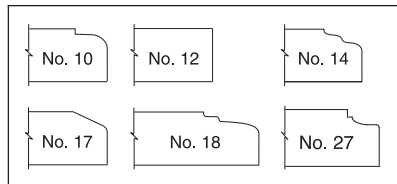

Profiled and Finished Edges

PRO.ALL

N/A	N/A	N/A	0	0	per part
N/A	N/A	N/A	15%	15%	per part

Specify PRO.FRT (Profiled and Finished Front), PRO.FRT.L (Profiled and Finished Front and Left), PRO.FRT.R (Profiled and Finished Front and Right), PRO.FRT.BK (Profiled and Finished Front and Back), PRO.FRT.L.R (Profiled and Finished Front, Left and Right), PRO.FRT.L.BK (Profiled and Finished Front, Left and Back), PRO.FRT.R.BK (Profiled and Finished Front, Right and Back), PRO.L.R (Profiled and Finished Left and Right), or PRO.ALL (Profiled and Finished All Edges)

With this option, finish will match the finish selected on the order. This will be applied to the specified sides.

- Material must follow specifications below to be available with this option:
 - Minimum length: 3", maximum length: 96"
 - Minimum width: 1 1/2", maximum width: 23 3/4"
 - Edge profile will match door profile selected (#10, #12, #14, #17, #18, #27).
- Available on:
 - 3/4SOLID, SHELFSLD, Hearth Shelf and Straight Valance.

Door and Drawer Front Modifications

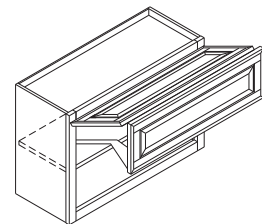

Automatic Opening Mechanism for Lift Up System

Specify AOMD (Automatic Opening Mechanism for Lift Up Systems)

A light touch on the front using your hand or elbow is all that's required to open doors with Automatic Opening Mechanism.

- AOMD available on the following:
 - WTH_BF, WTH_15SL, WTH_18SL, WTH_21SL, WTH_24SL, WV, STWAG, and DW_AG.
- Automatic Opening Mechanism is not available on WV, STWAG and DW_AG units when used with the following door styles:
 - Brooks, Gunther, Karis, Langley, Montgomery, Shona, and Vesta.
- See page S•13 for Automatic Opening Mechanism accessories and parts.

Wall	Base	Tall	Filler	Panel	
3265	3265	3265	N/A	N/A	per cabinet

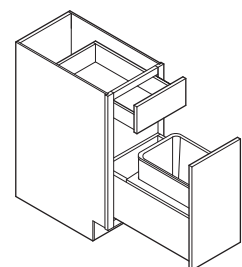

Automatic Opening Mechanism for Wastebaskets

Specify AOMBWB (Automatic Opening Mechanism for Wastebaskets)

A light touch on the front using your hand or knee is all that's required to open doors with Automatic Opening Mechanism.

- AOMBWB available on the following:
 - BWB15, BWB18, BWB21, BWB24, BWB15BB, BWB18BB, BWB21BB, BWB24BB, BWB18CHGDRW, BWB15FH, BWB18FH, BWB21FH, BWB24FH, BWB18KUP, BWB15WTCD, BWB18WTCD, BWB21WTCD, BWB24WTCD.
- See page S•13 for Automatic Opening Mechanism accessories and parts.

N/A	2245	N/A	N/A	N/A	per cabinet
-----	------	-----	-----	-----	-------------

Custom Modifications

Door and Drawer Front Modifications (cont'd)

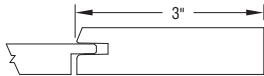
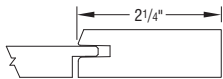
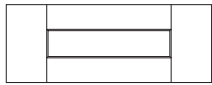

Sumner

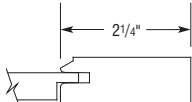
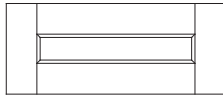

Shona

Drawer Front Flat 5-piece

Wall	Base	Tall	Filler	Panel	
60	60	60	N/A	N/A	per drawer

Specify DFF5PC (Drawer Front Flat 5-piece)

Drawer Front Flat 5-piece (DFF5PC) includes a 5-piece flat panel drawer.

- Under Counter Drawers and Keyboard Trays will be slab.
- Drawer fronts smaller than 5 3/4" high will have slab front.
- Available on:
 - Most cabinets with drawers featuring Sumner and Shona.

Drawer Front Flat 5-piece with Slab Top

60	60	60	N/A	N/A	per drawer
----	----	----	-----	-----	------------

Specify DFF5PCSLBT (Drawer Front Flat 5-piece, Slab Top)

Drawer Front Flat 5-piece with Slab Top includes a 5-piece flat panel drawer front, with the exception of the top front of base and vanity cabinets when the opening is 5" or 4 1/4", which will remain slab. Talls with drawer fronts at base/vanity height level will maintain the slab drawer front also, example UI _____. Drawer fronts smaller than 5 3/4" high will have slab front which includes Under Counter Drawers and Keyboard Trays.

- Available on:
 - Sumner and Shona.
- Not available on:
 - Add Drawer modification, W__364 models, and VWR1536.

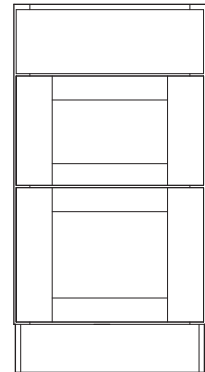

Drawer Front Flat 5-piece Inset

60	60	60	N/A	N/A	per drawer
----	----	----	-----	-----	------------

Specify DFF5PCINS (Drawer Front Flat 5-piece Inset)

Drawer Front Flat 5-piece Inset (DFF5PCINS) includes a 5-piece flat panel drawer. Changes drawer fronts on openings 6" high and greater from a slab front to a 5-piece flat panel drawer front.

- Drawer fronts on openings less than 6" high will remain a slab front. For example, only the bottom drawer front will change to a 5-piece flat panel front on a four drawer 4DB. On a 3DB, the middle and bottom will change to a 5-piece flat panel front.
- Available on:
 - Most cabinets with drawers featuring Brooks Beaded Inset, Brooks Inset, Shona Beaded Inset, Shona Inset, Tackett Beaded Inset, Tackett Inset, Vesta Beaded Inset, and Vesta Inset.

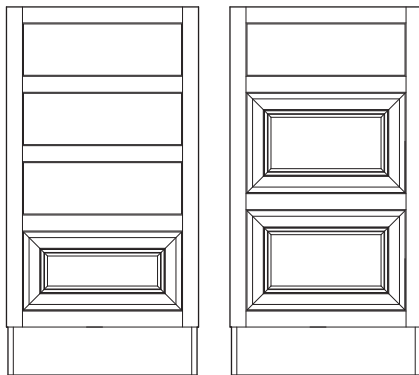

Door and Drawer Front Modifications (cont'd)

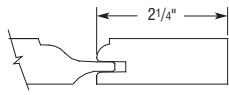
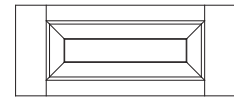

Drawer Side Rail / Center Panel Detail – Used on Top/Bottom Rail, when Drawer Front is over 6 3/4" High

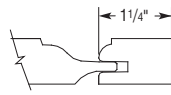

Drawer Top / Bottom Rail / Center Panel Detail – Used on 6 3/4" High and Less Drawer Fronts

Drawer Front Raised 5-piece

Wall	Base	Tall	Filler	Panel	
60	60	60	N/A	N/A	per drawer

Specify DFR5PC (Drawer Front Raised 5-piece)

Drawer Front Raised 5-piece (DFR5PC) includes a 5-piece double raised center panel drawer.

- End rails are 2 1/4" and crossrails are 1 1/4" (finished width). This rule will apply on all 4 1/4" and 5" high drawer openings.
- Any drawer openings larger than 5" high will utilize 2 1/4" end rails and crossrails.
- Under Counter Drawers, Drop Fronts (excluding Tilt-out Trays), and Keyboard Trays will be slab.
- Drawer fronts smaller than 5 3/4" high will have slab front.
- Available on:
 - Shona.

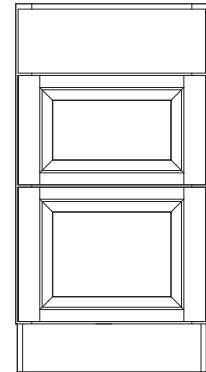

Drawer Front Raised 5-piece with Slab Top

60	60	60	N/A	N/A	per drawer
----	----	----	-----	-----	------------

Specify DFR5PCSLBT (Drawer Front Raised 5-piece, Slab Top)

Drawer Front Raised 5-piece with Slab Top includes a 5-piece double raised center panel drawer front, with the exception of the top front of base and vanity cabinets when the opening is 5" or 4 1/4", which will remain slab. Talls with drawer fronts at base/vanity height level will maintain the slab drawer front also, example UI____. End rails are 2 1/4" and crossrails are 1 1/4" (finished width). This rule will apply on all 4 1/4" and 5" high drawer openings, with the exception of top fronts. Any drawer openings larger than 5" high will utilize 2 1/4" end rails and crossrails. Drawer fronts smaller than 5 3/4" high will have slab front which includes Under Counter Drawers and Keyboard Trays.

- Available on:
 - Shona.
- Not available on:
 - Add Drawer modification, W____364 models, and VWR1536.

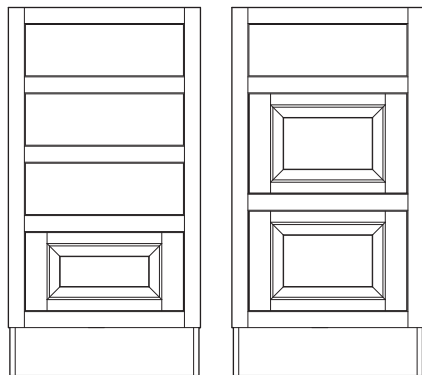

Drawer Front Raised 5-piece Inset

60	60	60	N/A	N/A	per drawer
----	----	----	-----	-----	------------

Specify DFR5PCINS (Drawer Front Raised 5-piece Inset)

Drawer Front Raised 5-piece Inset (DFR5PCINS) includes a 5-piece double raised panel drawer. Changes drawer fronts on openings 6" high and greater from a slab front to a 5-piece raised panel drawer front.

- Drawer fronts on openings less than 6" high will remain a slab front. For example, only the bottom drawer front will change to a 5-piece raised panel front on a four drawer 4DB. On a 3DB, the middle and bottom will change to a 5-piece raised panel front.
- Available on:
 - Most cabinets with drawers featuring Daxton Beaded Inset, Daxton Inset, Shona Beaded Inset and Shona Inset.

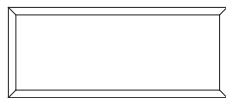

Drawer Front Slab

0	0	0	N/A	N/A	per drawer
---	---	---	-----	-----	------------

Specify DFSLB (Drawer Front Slab)

Drawer Front Slab (DFSLB) includes a solid slab drawer front.

- Available on:
 - Brooks, Daxton, Caldera, Gunther, Gunther Beaded Inset, Gunther Inset, Wells, Karis, Karis Beaded Inset, Karis Inset, Langley, Langley Beaded Inset, Langley Inset, Montgomery, Montgomery Beaded Inset, Montgomery Inset, Tackett, and Vesta.

Custom Modifications

Door and Drawer Front Modifications (cont'd)

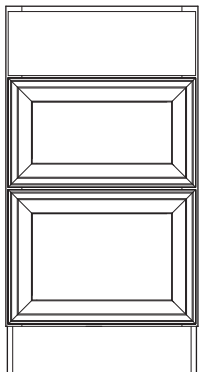

Drawer Front Slab Top

Wall	Base	Tall	Filler	Panel	
0	0	0	N/A	N/A	per drawer

Specify DFSLBT (Drawer Front Slab Top)

Drawer Front Slab Top (DFSLBT) includes a solid slab drawer front on the top front of base and vanity cabinets when the opening is 5" or 4 1/4". Tall drawers with drawer fronts at base/vanity height level will also be changed to slab, example UI _____.

- Available on:
 - Brooks, Daxton, Caldera, Gunther, Gunther Beaded Inset, Gunther Inset, Wells, Karis, Karis Beaded Inset, Karis Inset, Langley, Langley Beaded Inset, Langley Inset, Montgomery, Montgomery Beaded Inset, Montgomery Inset, Tackett, and Vesta.
- Not available on:
 - Add Drawer modification, W__364 models, and VWR1536.

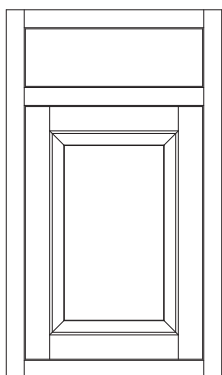

Shona Inset

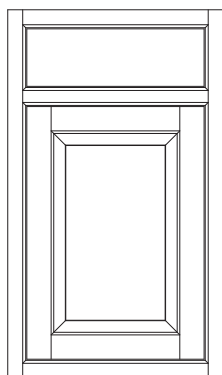

Shona Beaded Inset

Inset & Beaded Inset Doors

15%	15%	15%	N/A	N/A	per cabinet
-----	-----	-----	-----	-----	-------------

Specify NOBEAD (Inset Door Styles) or BEADED (Beaded Inset Door Styles)

With this option, the door style selected will follow the Inset and Beaded Inset style requirements.

- Wall Cabinets are a standard 13" deep.
- Standard hinge is a 6-way adjustable Smart Stop concealed hinge. Finial hinges (IFAB, IFBN, IFMB, IFORB) are available at no additional charge, see modification for details.
- Not available on Inset and Beaded Inset:
 - Authentic Ends (AUTHL, AUTHR, AUTHB), Drawer Front Flat 5-piece (DFF5PC), Drawer Front Raised 5-piece (DFR5PC), Extended Stile w/Overlay (EXLOL, EXROL), Face Frame and Door on End (FFD), Integral Ends (INTGEL, INTGER), Modified Full Overlay (MFO), and Wood Tops for Angled End Base Cabinets (WTOPBAC, WTOPBEC).
- Not available on Beaded Inset:
 - Top Valance Rail - Arch (TVRAV), Top Valance Rail - Style B (TVRB), Top Valance Rail - Style D (TVRD), Top Valance Rail - Style E (TVRE), Top Valance Rail - Style H (TVRH), Top Valance Rail - Style J (TVRJ), Top Valance Rail - Style K (TVRK), and Top Valance Rail - Style L (TVRL).
- Available styles include:
 - Brooks, Daxton, Gunther, Karis, Langley, Montgomery, Trystan, Shona, Tackett, and Vesta. These styles are featured under the Door Style section. Please see pages D•12-D•17 for more details.
- See individual cabinets for availability.

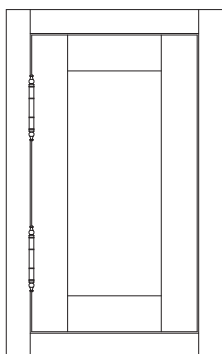

Inset Finial Hinges

0	0	0	N/A	N/A	per hinge
---	---	---	-----	-----	-----------

Specify IFAB (Inset Finial Hinge - Antique Brass), IFBN (Inset Finial Hinge - Brushed Nickel), IFMB (Inset Finial Hinge - Matte Black), or IFORB (Inset Finial Hinge - Oil Rubbed Bronze)

With this option, finial hinges will be attached to the door.

- Special placement of finial hinges is not available.
- Hinge will not feature Smart Stop.
- 180 degree hinge.
- Four way adjustable hinge (left, right, up and down).
- Available on:
 - Inset and Beaded Inset door styles with #12 profile only.
- Not available on:
 - Aluminum Frame Doors and Inset Panel Ends.

Door and Drawer Front Modifications (cont'd)

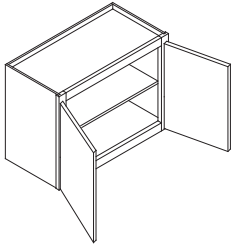

Modified Full Overlay

Wall	Base	Tall	Filler	Panel	
0	N/A	0	N/A	N/A	per cabinet

Specify MFO (Modified Full Overlay)

Full Overlay Cabinets can be ordered with a modified full overlay. Modified Full Overlay will reduce the size of the top door by 13/16" allowing for a reveal of 1 1/32".

- When Modified Full Overlay is specified it will be applied to all Wall and Tall cabinets on order.
- When ordering two wall cabinets that will be field stacked, both cabinets will come with Modified Full Overlay unless otherwise specified.
- Modified Full Overlay adjustment will not occur on Wall Cabinets with Add Toekick modification.
- When Integral Ends are ordered in conjunction with Modified Full Overlay, the cross rail will not increase to match the change in reveal.
- When Fluting modifications are selected in conjunction with Modified Full Overlay, the Fluting dimensions do not change.
- When Transom modification is selected in conjunction with Modified Full Overlay, the bottom section of door will decrease in height by 13/16".
- Available on:
 - Most wall and tall cabinets, see individual cabinets for availability.
- Not available on:
 - Aluminum Frame Doors, Inset Doors, Beaded Inset Doors, Inset Finial Hinges, and Inset Panel Ends.

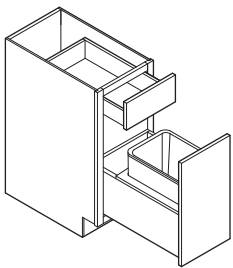

Push-to-Open Wastebasket

N/A	525	N/A	N/A	N/A	per cabinet
-----	-----	-----	-----	-----	-------------

Specify PTOWB (Push-to-Open Wastebasket)

- Available on:
 - BWB15, BWB18, BWB21, BWB15BB, BWB18BB, BWB21BB, BWB18CHGDRW, BWB15FH, BWB18FH, BWB21FH, BWB15FHKIT, BWB18FHKIT, BWB21FHKIT, BWB18KCUP, BWB15KIT, BWB18KIT, BWB21KIT, BWB15WTCD, BWB18WTCD, BWB21WTCD.
- Changes the guide mechanism on wastebasket pull-outs to a mechanical push to open guide with Smart Stop.
- Available on 24" deep cabinets only.
- Does not change other drawer guides on the cabinet.

Single Panel Tall Door

N/A	N/A	0	N/A	N/A	per door
-----	-----	---	-----	-----	----------

Specify SGLPN (Single Panel Tall Door)

Single Panel Tall Door modification is available on most tall cabinets with 58 1/2" opening heights.

- This modification will allow doors with a 58 1/2" opening height to consist of a single center panel rather than the standard 2 equally sized center panels divided by a horizontal rail.
- When used in conjunction with Face Frame and Door on End, Inset Panel Ends, and Authentic Flush End modifications, the SGLPN logic will be applied by changing the tall door to a single center panel.
- Door styles not available include: Trystan.

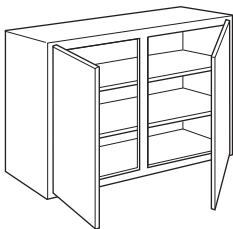

Split Doors

0	0	0	N/A	N/A	per cabinet
---	---	---	-----	-----	-------------

Specify SPLITDR, SPLITDR.LL (Split Doors Left-Hinged), SPLITDR.RR (Split Doors Right-Hinged), SPLITDR.P (Split Doors - Peninsula), SPLITDR.LL.P (Split Doors Left - Hinged - Peninsula), or SPLITDR.RR.P (Split Doors Right - Hinged - Peninsula)

Butt Doors are standard on double door cabinets 24" to 39" wide. If a center face frame mullion is desired, specify the Split Doors option. If the unit includes a drawer, the drawer is one wide drawer unless the Split Drawers option is selected.

- Not available on:
 - Top Valance Rail.

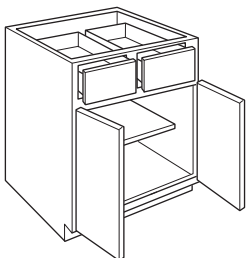

Split Drawers

N/A	0	0	N/A	N/A	per cabinet
-----	---	---	-----	-----	-------------

Specify SPLITDRWS (Split Drawers)

When a unit includes a drawer, one wide drawer configuration is standard. If two small, side-by-side drawers are desired, specify the Split Drawers option.

- Split Drawer front widths will not be aligned with the doors unless the Split Doors option is specified.
- When Split Drawers are specified on a drawer base, only the top drawer will be split.
- Minimum cabinet width is 24". Maximum cabinet width is 39".

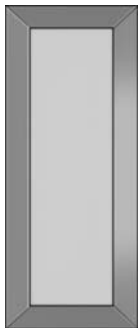

Aluminum Door

Wall	Base	Tall	Filler	Panel
see Specialty Doors for details				

Specify AF003 (Aluminum Frame profile 003), AF006 (Aluminum Frame profile 006), or AF007 (Aluminum Frame profile 007)
 Specify Finish NA (Natural Aluminum), S (Brushed Stainless), RB (Rubbed Bronze), W (White), or B (Black)
 Specify Insert, see page H•17 for selections.

- Cabinets can be ordered with Aluminum Frame doors with insert.
- Must specify Matching Interior if desired. When a decorative door option is chosen in 20/20, Matching Interior Plywood (MIP) is a preselected option. If MIP is not desired, it can be deselected by choosing NOTMIP.
 - Limited cabinet availability.
 - Face Frame and Door on End option will always match the face.
 - See Specialty doors for availability.

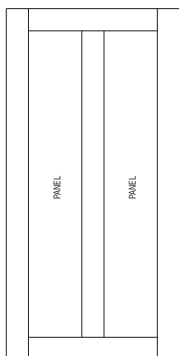

CCP
(Two Center Panels)

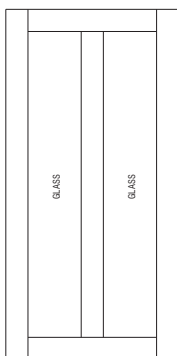

CCG
(Two sections Cut-for-glass)

Craftsman Door

see Specialty Doors for details				
---------------------------------	--	--	--	--

Specify CCP (Two center panels), CCG (Two sections Cut-for-glass), CCG.TOP (Two sections Cut-for-glass - Top Door), CCG.BTM (Two sections Cut-for-glass - Bottom Door), CCG.P (Two sections Cut-for-glass - Peninsula), CCP.TOP (Two center panels - Top Door), CCP.BTM (Two center panels - Bottom Door), or CCP.P (Two center panels - Peninsula).

- Cabinets can be ordered with Craftsman Door.
- Both sections will be equal size.
 - Doors sections will be split with a vertical center door mullion.
 - Due to the width and height size limitations for Craftsman Doors, the Authentic Flush End modification may not match the Craftsman Door configuration specified. The door configuration for Authentic Flush End modification will be the CCP option when achievable (Cut-for-glass is not available), otherwise the door configuration will match the door style of the order. Refer to page H•9 for minimum width and height by style.
 - Due to the width and height size limitations for Craftsman Doors, the Face Frame and Door on End modification may not match the Craftsman Door configuration specified. The door configuration for Face Frame and Door on End modification will match the Craftsman option chosen when achievable, otherwise the door configuration will match the door style of the order. Refer to page H•9 for minimum width and height by style.
 - If Craftsman option is selected in conjunction with IPEL or IPER option, the Inset Panel End doors will NOT match the front doors on the cabinet. They will remain standard doors on the Inset Panel End side.
 - If Craftsman option is selected in conjunction with INTGEL or INTGER option, the INTEGRAL doors will NOT match the front doors on the cabinet. They will remain standard doors on the integral side.
 - Glass is not included. When ordering glass, two equal sizes of glass will be required. Art Glass not available.
 - Craftsman modification is available on Wall cabinets only.
 - See Specialty doors for availability.
 - When a decorative door option is chosen in 20/20 for CCG, Matching Interior Plywood (MIP) is a preselected option. If MIP is not desired, it can be deselected by choosing NOTMIP.

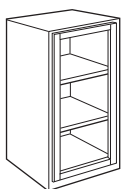

Cut-for-glass

0	0	0	N/A	N/A	per door
---	---	---	-----	-----	----------

Specify CG (Cut-for-glass), CG.TOP (Cut-for-glass Top), CG.MID (Cut-for-glass Middle), CG.BTM (Cut-for-glass Bottom), or CG.P (Cut-for-glass Peninsula)

- Cabinets can be ordered with doors routed to accept glass inserts. Clips to attach glass are included.
- Doors more than 54" tall have two panels routed for glass, divided by a horizontal mullion.
 - Glass is not included.
 - Must specify Matching Interior if desired. When a decorative door option is chosen in 20/20, Matching Interior Plywood (MIP) is a preselected option. If MIP is not desired, it can be deselected by choosing NOTMIP.
 - Not available on:
 - Cabinets with bifold doors.

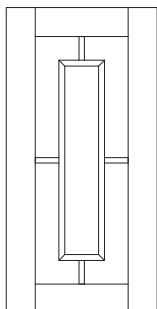

Gallery Mullion Door

see Specialty Doors for details				
---------------------------------	--	--	--	--

Specify GAMD (Gallery Mullion Door) door location, GAMD.TOP (top door), GAMD.MID (middle door), GAMD.BTM (bottom door), or GAMD.P (peninsula door)

- With this option, doors will feature a mullion cut-out. Clips to attach glass are included. All doors feature a square door style.
- Must specify Matching Interior if desired. When a decorative door option is chosen in 20/20, Matching Interior Plywood (MIP) is a preselected option. If MIP is not desired, it can be deselected by choosing NOTMIP.
 - Glass is not included.
 - See Specialty doors for availability.

Specialty Door Modifications (cont'd)

Wall Base Tall Filler Panel

see Specialty Doors for details

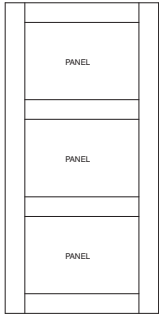

HCP
(Center panels)

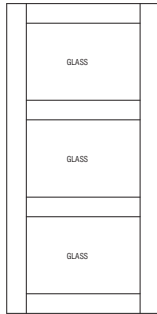

HCG
(Cut-for-glass)

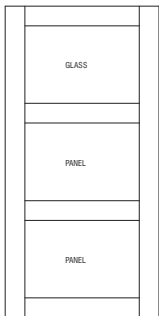

HCGCP
(Cut-for-glass top and center panels)

Horizon Door

Specify HCP (Three equal panels), HCG (Three equal sections Cut-for-glass), HCGCP (Three equal sections. Top section is Cut-for-glass. Bottom two sections have panels), HCG.TOP (Three equal sections Cut-for-glass - Top Door), HCG.BTM (Three equal sections Cut-for-glass - Bottom Door), HCG.P (Three equal sections Cut-for-glass - Peninsula), HCGCP.TOP (Three equal sections. Top section is Cut-for-glass. Bottom two sections have panels - Top Door), HCGCP.BTM (Three equal sections. Top section is Cut-for-glass. Bottom two sections have panels - Bottom Door), HCGCP.P (Three equal sections. Top section is Cut-for-glass. Bottom two sections have panels - Peninsula), HCP.TOP (Three equal panels - Top Door), HCP.BTM (Three equal panels - Bottom Door), or HCP.P (Three equal panels - Peninsula).

Cabinets can be ordered with Horizon Door.

- All three sections will be equal size.
- Due to the width and height size limitations for Horizon Doors, the Authentic Flush End modification may not match the Horizon Door configuration specified. The door configuration for Authentic Flush End modification will be the HCP option when achievable (Cut-for-glass is not available), otherwise the door configuration will match the door style of the order. Refer to page H•10 for minimum width and height by style.
- Due to the width and height size limitations for Horizon Doors, the Face Frame and Door on End modification may not match the Horizon Door configuration specified. The door configuration for Face Frame and Door on End modification will match the Horizon option chosen when achievable, otherwise the door configuration will match the door style of the order. Refer to page H•10 for minimum width and height by style.
- If Horizon option is selected in conjunction with IPEL or IPER option, the Inset Panel End doors will NOT match the front doors on the cabinet. They will remain standard doors on the Inset Panel End side.
- If Horizon option is selected in conjunction with INTGEL or INTGER option, the INTEGRAL doors will NOT match the front doors on the cabinet. They will remain standard doors on the integral side.
- When Modified Full Overlay modification is selected in conjunction with Horizon, the three sections will remain equal.
- Glass is not included. When ordering glass, three equal sizes of glass will be required. Art Glass not available.
- Horizon modification is available on Wall cabinets only.
- See Specialty doors for availability.
- When a decorative door option is chosen in 20/20 for HCG or HCGCP, Matching Interior Plywood (MIP) is a preselected option. If MIP is not desired, it can be deselected by choosing NOTMIP.

see Specialty Doors for details

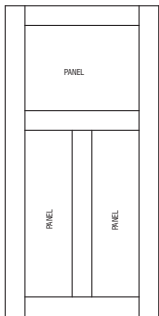

MCP
(Center panels)

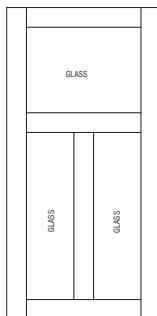

MCG
(Cut-for-glass)

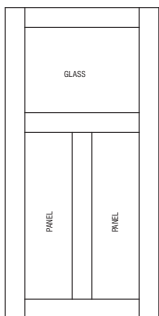

MCGCP
(Cut-for-glass top and center panels)

Mission Door

Specify MCP (Three center panels), MCG (Three sections Cut-for-glass), MCGCP (Three sections. Top section is Cut-for-glass. Bottom two sections have panels), MCG.TOP (Three sections Cut-for-glass - Top Door), MCG.BTM (Three sections Cut-for-glass - Bottom Door), MCG.P (Three sections Cut-for-glass - Peninsula), MCGCP.TOP (Three sections. Top section is Cut-for-glass. Bottom two sections have panels - Top Door), MCGCP.BTM (Three sections Cut-for-glass. Top section is Cut-for-glass. Bottom two sections have panels - Bottom Door), MCGCP.P (Three sections Cut-for-glass. Top section is Cut-for-glass. Bottom two sections have panels - Peninsula), MCP.TOP (Three center panels - Top Door), MCP.BTM (Three center panels - Bottom Door), or MCP.P (Three center panels - Peninsula).

Cabinets can be ordered with Mission Door.

- The upper section of the door will always have a 12" tall section, which includes the width of the upper crossrails and the upper opening.
- Due to the width and height size limitations for Mission Doors, the Authentic Flush End modification may not match the Mission Door configuration specified. The door configuration for Authentic Flush End modification will be the MCP option when achievable (Cut-for-glass is not available), otherwise the door configuration will match the door style of the order. Refer to page H•12 for minimum width and height by style.
- Due to the width and height size limitations for Mission Doors, the Face Frame and Door on End modification may not match the Mission Door configuration specified. The door configuration for Face Frame and Door on End modification will match the Mission option chosen when achievable, otherwise the door configuration will match the door style of the order. Refer to page H•12 for minimum width and height by style.
- If Mission option is selected in conjunction with IPEL or IPER option, the Inset Panel End doors will NOT match the front doors on the cabinet. They will remain standard doors on the Inset Panel End side.
- If Mission option is selected in conjunction with INTGEL or INTGER option, the INTEGRAL doors will NOT match the front doors on the cabinet. They will remain standard doors on the integral side.
- Glass is not included. When ordering glass, three separate pieces of glass in two sizes will be required. Art Glass not available.
- Mission modification is available on Wall cabinets only.
- See Specialty doors for availability.
- When a decorative door option is chosen in 20/20 for MCG or MCGCP, Matching Interior Plywood (MIP) is a preselected option. If MIP is not desired, it can be deselected by choosing NOTMIP.

Custom Modifications

Specialty Door Modifications (cont'd)

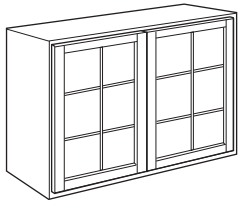

Mullion Doors

Wall Base Tall Filler Panel

see Specialty Doors for details

Specify MD (Mullion Door), MD.TOP (Mullion Door Top), MD.MID (Mullion Door Middle), MD.BTM (Mullion Door Bottom), or MD.P (Mullion Door Peninsula)

With this option, doors will feature a mullion cut-out. Clips to attach glass are included. See the Specialty Doors section for style availability and complete ordering information and size limitations.

- Must specify Matching Interior if desired. When a decorative door option is chosen in 20/20, Matching Interior Plywood (MIP) is a preselected option. If MIP is not desired, it can be deselected by choosing NOTMIP.
- Glass is not included.
- Not available on:
 - Brooks, Brooks Beaded Inset, Brooks Inset, Daxton, Daxton Beaded Inset, Daxton Inset, Wells, Langley, Langley Beaded Inset, Langley Inset, Trystan, Trystan Beaded Inset, Trystan Inset, Tackett, Tackett Beaded Inset, Tackett Inset, Vesta Beaded Inset, and Vesta Inset.
 - Cabinets with bifold doors, 9" wide cabinets and cabinets less than 15" high or taller than 48" high.

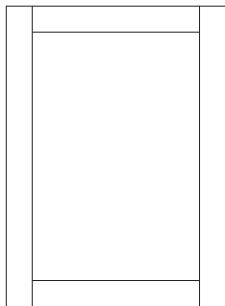

No Hinge Cut

0	0	0	N/A	N/A	per door
---	---	---	-----	-----	----------

Specify NHC (No Hinge Cut)

- Available on:
 - DOORONLY.

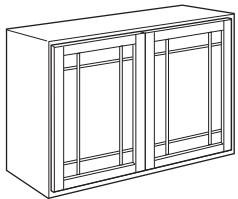

Prairie Mullion Doors

see Specialty Doors for details

Specify PRMD (Prairie Mullion Door), PRMD.TOP (Prairie Mullion Door Top), PRMD.MID (Prairie Mullion Door Middle), PRMD.BTM (Prairie Mullion Door Bottom), or PRMD.P (Prairie Mullion Door Peninsula)

With this option, door will feature a prairie mullion cut-out. Clips to attach glass are included. All doors feature a square door style.

- Must specify Matching Interior if desired. When a decorative door option is chosen in 20/20, Matching Interior Plywood (MIP) is a preselected option. If MIP is not desired, it can be deselected by choosing NOTMIP.
- Glass is not included.
- Not available on:
 - Brooks, Brooks Beaded Inset, Brooks Inset, Daxton, Daxton Beaded Inset, Daxton Inset, Wells, Langley, Langley Beaded Inset, Langley Inset, Trystan, Trystan Beaded Inset, Trystan Inset, Tackett, Tackett Beaded Inset, Tackett Inset, Vesta Beaded Inset, and Vesta Inset.
 - Cabinets with bifold doors, 12" wide and 24" wide two door cabinets.

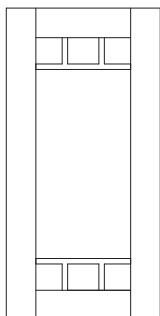

Shaker Mullion Door

see Specialty Doors for details

Specify SHMD (Shaker Mullion Door) door location, SHMD.TOP (top door), SHMD.MID (middle door), SHMD.BTM (bottom door), or SHMD.P (peninsula door)

With this option, doors will feature a mullion cut-out. Clips to attach glass are included. All doors feature a square door style.

- Must specify Matching Interior if desired. When a decorative door option is chosen in 20/20, Matching Interior Plywood (MIP) is a preselected option. If MIP is not desired, it can be deselected by choosing NOTMIP.
- Glass is not included.
- See Specialty doors for availability.

Specialty Door Modifications (cont'd)

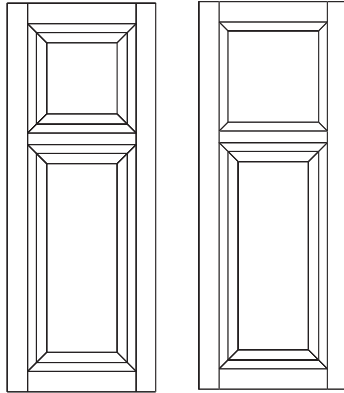

TCP (Transom with both sections Center Panel)

TCG (Transom with Top Cut-for-glass and Bottom Center Panel)

Transom Doors

Specify TCP (Transom with both sections Center Panels),
 TCG (Transom with Top Cut-for-glass and Bottom Center Panel),
 TCPCG (Transom with Top Center Panel and Bottom Cut-for-glass),
 TCGCG (Transom with both sections Cut-for-glass),
 TCP.TOP (Transom with both sections Center Panels - Top Door),
 TCG.TOP (Transom with Top Cut-for-glass and Bottom Center Panel - Top Door),
 TCPCG.TOP (Transom with Top Center Panel and Bottom Cut-for-glass - Top Door),
 TCGCG.TOP (Transom with both sections Cut-for-glass - Top Door),
 TCP.P (Transom with both sections Center Panels - Peninsula),
 TCG.P (Transom with Top Cut-for-glass and Bottom Center Panel - Peninsula),
 TCPCG.P (Transom with Top Center Panel and Bottom Cut-for-glass - Peninsula), or
 TCGCG.P (Transom with both sections Cut-for-glass - Peninsula)

	Wall	Base	Tall	Filler	Panel
TCP	140	N/A	N/A	N/A	N/A per door
TCG	140	N/A	N/A	N/A	N/A per door

Cabinets can be ordered with Transom Doors. Clips to attach glass are included.

- The upper section of the door will always have a 12" tall section, which includes the width of the upper crossrails and the upper opening.
- Authentic End will always be Transom with both sections Center Panel.
- Face Frame and Door on End option will always match the face.
- Center panel standard on lower section. Cut-for-glass Door option available on lower section.
- When Modified Full Overlay modification is selected in conjunction with Transom, the bottom section of door will decrease in height by 1 inch.
- Glass is not included.
- Available on:
 - Daxton, Caldera, Gunther, Sumner, Karis, Montgomery, and Tackett.
 - 36", 39", 42", 45" and 48" high doors.
- Transom with Top for Glass and Bottom Center Panel (TCG) not available on:
 - Corner Walls and Wall Message Centers.
- Transom Doors are not available on stacked wall units.
- When a decorative door option is chosen in 20/20 for TCG, TCPCG or TCGCG, Matching Interior Plywood (MIP) is a preselected option. If MIP is not desired, it can be deselected by choosing NOTMIP.

Custom Modifications

Cabinet Box Frame Modifications

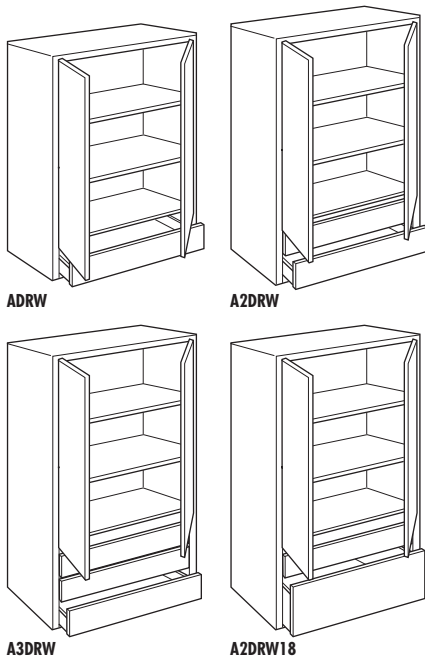

Add Drawer Below Wall Unit

Specify ADRW (Add One Drawer Below Wall Unit, increases height by 6"), A2DRW (Add Two Drawers below Wall Unit, increases height by 12"), A3DRW (Add Three Drawers below Wall Unit, increases height by 18"), or A2DRW18 (Add Two Drawers below Wall Unit, increases height by 18")

- Most wall cabinets can have full width drawer(s) added below a wall unit. With this option the overall height of the cabinet increases.
- ADRW adds one full width drawer below wall unit, 4 1/4" drawer opening height. The height increases by 6". The maximum cabinet height is 60" before drawers are added. Maximum overall cabinet height is 66".
- A2DRW adds two full width drawers below wall unit, both at 4 1/4" drawer opening heights. The height increases by 12". The maximum cabinet height is 54" before drawers are added. Maximum overall cabinet height is 66".
- A3DRW adds three full width drawers below wall unit, all at 4 1/4" drawer opening heights. The height increases by 18". The maximum cabinet height is 48" before drawers are added. Maximum overall cabinet height is 66".
- A2DRW18 adds one full width drawer with a 4 1/4" drawer opening height and one full width drawer with a 10 1/4" drawer opening height. The height increases by 18". The maximum cabinet height is 48" before drawers are added. Maximum overall cabinet height is 66".
- Maximum cabinet width is 48".
- Inset and Beaded Inset will feature a slab drawer front on the 4 1/4" opening heights with this option.
- Increased or Reduced Depth available in 1/4" increments from 12" to 24".
- Not available on:
 - Peninsula cabinets or in conjunction with Finished Bottom.

	Wall	Base	Tall	Filler	Panel
1 Drawer	280	N/A	N/A	N/A	N/A per cabinet
2 Drawers	540	N/A	N/A	N/A	N/A per cabinet
3 Drawers	820	N/A	N/A	N/A	N/A per cabinet



Bottom Valance Rail

165	N/A	N/A	25%	25%	per cabinet
-----	-----	-----	-----	-----	-------------

- Specify BVR (Bottom Valance Rail) _____ and fill in the added height dimension required
- The standard 1 1/2" bottom rail on wall cabinets can be increased in 1/4" increments up to an additional 3 1/2".
- Ends and back are extended down with the frame. If desired, field modification is possible.
 - The overall height of the cabinet increases by the amount of Bottom Valance Rail specified.
 - When Finished Bottom option is selected, additional blocking in field may be required.
 - When Bottom Valance Rail is specified in conjunction with Integral Ends, the cross rails on the End Panel will not increase to match the extension.

Cabinet Box Frame Modifications (cont'd)

Wall	Base	Tall	Filler	Panel	
-15%	-15%	-15%	N/A	N/A	per cabinet

Cabinet Box Only

Specify CBO (Cabinet Box Only)

With this option, the doors and/or drawer fronts are removed (no hinge drilling on face frame).

- Complete drawer box and any interior components remain in cabinet.
- Contact Customer Service for more details.

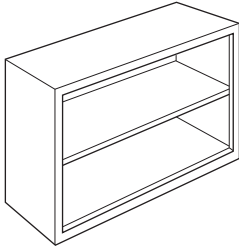

Cabinets less doors - Wall

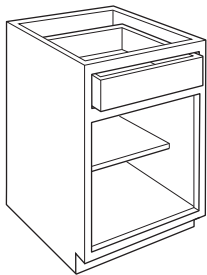

Cabinets less doors and drawers fronts - Base and Vanity

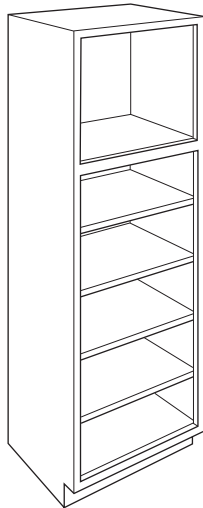

Cabinet less doors - Tall

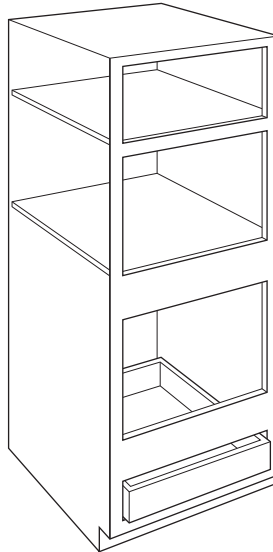

Cabinet less doors and drawer fronts - Tall

Cabinet Case Only

Specify CCO (Cabinet Case Only)

With this option, the doors (no hinge drilling on face frame), drawer fronts, hardware and interior components are removed.

Wall	Base	Tall	Filler	Panel	
-15%	-15%	-15%	N/A	N/A	per cabinet

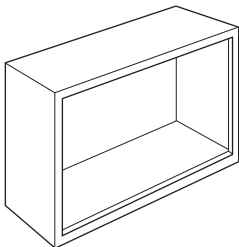

Cabinet case only - Wall

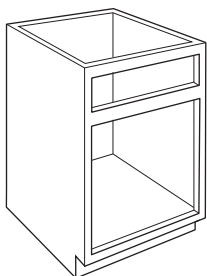

Cabinet case only - Base and Vanity

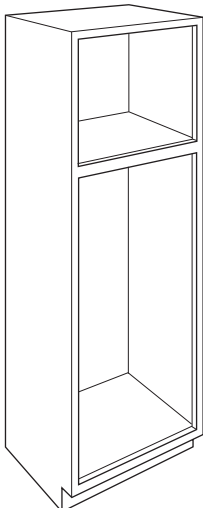

Cabinet case only - Tall

Custom Modifications

Cabinet Box Frame Modifications (cont'd)

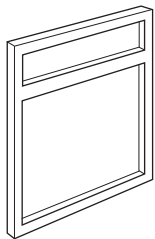

Cabinet Frame Only

Specify CFRMO (Cabinet Frame Only)

With this option, the cabinet, doors, hinges, drawers, and drawer fronts are removed.

Wall	Base	Tall	Filler	Panel	
-75%	-75%	-75%	N/A	N/A	per cabinet

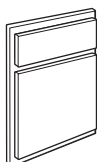

Cabinet Front Only

Specify CFNTO (Cabinet Front Only)

The top and bottom edges of the frame are not available in finished quality. While the vertical edges are finished, the standard groove to accept the 1/2" end panel is on the back vertical edge of all Face Frames and Doors.

When Cabinet Front Only (CFNTO) is selected, the following modification upcharges will apply:

- Drawer Front
- Split Doors
- Split Drawers
- Clip Corners
- Fluting
- Cut-for-glass
- Mullion Doors
- Prairie Mullion Doors
- Doors
- Finish Techniques
- Glazes
- Wide Stile
- Glass
- Finial Hinges

-25%	-25%	-25%	N/A	N/A	per cabinet
------	------	------	-----	-----	-------------

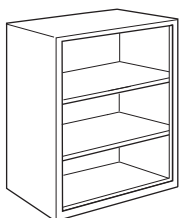

Cabinet No Door

Specify CND (Cabinet No Door), CND.TOP (Cabinet No Door Top), CND.MID (Cabinet No Door Middle), CND.BTM (Cabinet No Door Bottom), or CND.P (Cabinet No Door Peninsula)

Cabinets can be ordered without doors (no hinge drilling on face frame). The interior of the cabinet is Natural unless a Matching Interior is specified.

- Complete drawer box and any interior components remain in cabinet.
- Hinges are not included.
- Openings larger than 36" wide will have center face frame mullion.

-15%	-15%	-15%	N/A	N/A	per cabinet
------	------	------	-----	-----	-------------

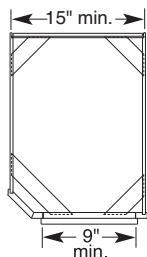
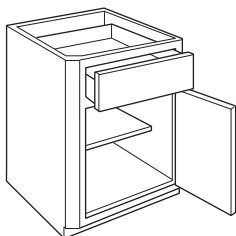

3" Clipped Corner

Specify CLIP3L (Clipped Left Corner), CLIP3R (Clipped Right Corner), CLIP3L.P (Clipped Left Corner Peninsula), or CLIP3R.P (Clipped Right Corner Peninsula)

Many cabinets can be ordered with either the left or right front corners of the face frame clipped at a 45° angle. The Clipped Corner side end panel is set back 3" by the clip. The size of the face frame opening is reduced by 3" with one clip. The overall width of the cabinet does not change.

- The Clipped Corners are available with fluting, but this must be specified.
- Minimum face frame opening is 9" after Clipped Corner option is applied.
- Minimum depth of cabinet is 9".
- When cabinet is clipped to 21" opening, specify one or two doors.
- When IW is used in conjunction with Clipped Corners, then not available with 24" wide Peninsulas, B4D_, B4D_RT, B39RT, B42RT, or B45RT models.
- When IW is used in conjunction with Clipped Corners and it makes the opening 21" wide, then cabinet will have 2 doors.
- Not available on:
 - Face Frame and Door on End, Extended Stiles, Inset Panel Ends, or Wide Stiles are not available on same side as the Clipped Corner.

410	480	540	N/A	N/A	per side
-----	-----	-----	-----	-----	----------

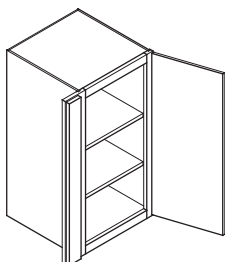

Extended Stile with Overlay

Specify EXLLOL (Extended Left Stile with Overlay), EXROL (Extended Right Stile with Overlay), EXBOL (Extended Left and Right Stiles with Overlay), EXLLOL.P (Extended Left Stile with Overlay Peninsula Side), EXROL.P (Extended Right Stile with Overlay Peninsula Side), or EXBOL.P (Extended Left and Right Stile with Overlay Peninsula Side)

Cabinets can be ordered with Extended Stiles of 3" that include a 2 9/16" profiled overlay. The overlay is sent loose for field trimming.

- Overlays cannot be fluted.
- When ordered with #18 profile, #14 profile will be used.
- Not available:
 - Inset and Beaded Inset Door styles.

0	0	0	N/A	0	per stile
---	---	---	-----	---	-----------

Cabinet Box Frame Modifications (cont'd)

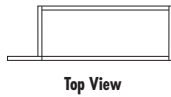
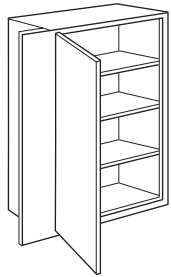

Extended Stiles

Wall	Base	Tall	Filler	Panel	
0	0	0	N/A	N/A	per stile

Specify EXL (Extended Left Stile), EXR (Extended Right Stile), EXL.P (Extended Left Stile Peninsula Side), or EXR.P (Extended Right Stile Peninsula Side) and fill in the added dimension required

To eliminate the need for fillers, cabinets can be ordered with Extended Stiles. Two options are available when ordering Extended Stiles: 1/8" only or 1/4" increments up to an additional 3".

- When the cabinet has doors, Flute option available on 3" Extended Stiles only.
- 1/8" EXL and/or EXR options recommended on cabinets with #12 profile selected when the adjacent cabinets are ordered with altered depths or next to a fixed wall. See page D•1 for details. Applies to Full Overlay only.
- Not available on:
 - The angled end of any angled frame cabinet or clipped corner ends.

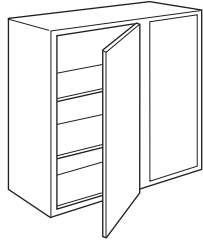

Finished Blind

140	140	N/A	N/A	N/A	per cabinet
-----	-----	-----	-----	-----	-------------

Specify FBFL (Finished Blind Left) or FBFR (Finished Blind Right)

The blind section of a square corner wall or blind corner base can be filled in to appear as a solid section.

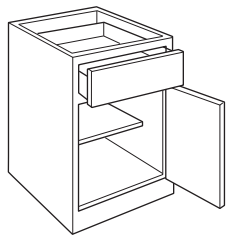

FTK

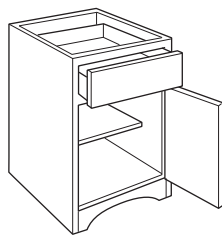

FTKAV

Flush Toekick

Specify FTK (Flush Toekick), FTK.P (Flush Toekick - Peninsula), FTKAV (Flush Toekick - Arch), FTKAV.P (Flush Toekick - Arch Peninsula), FTKB (Flush Toekick - Style B), FTKB.P (Flush Toekick - Style B Peninsula), FTKD (Flush Toekick - Style D), FTKD.P (Flush Toekick - Style D Peninsula), FTKE (Flush Toekick - Style E), FTKE.P (Flush Toekick - Style E Peninsula), FTKH (Flush Toekick - Style H), FTKH.P (Flush Toekick - Style H Peninsula), FTKJ (Flush Toekick - Style J), FTKJ.P (Flush Toekick - Style J Peninsula), FTKK (Flush Toekick - Style K), FTKK.P (Flush Toekick - Style K Peninsula), FTKL (Flush Toekick - Style L), or FTKL.P (Flush Toekick - Style L Peninsula)

Straight	0	0	0	0	0	per cabinet
Arch	0	0	0	0	0	per cabinet
Style B	0	0	0	0	0	per cabinet
Style D	0	0	0	0	0	per cabinet
Style E	0	0	0	0	0	per cabinet
Style H	0	0	0	0	0	per cabinet
Style J	0	0	0	0	0	per cabinet
Style K	0	0	0	0	0	per cabinet
Style L	0	0	0	0	0	per cabinet

The recessed toe space on base cabinets can be eliminated by extending the face frame down with the end panels.

- When Flush Toekick is selected for wall cabinets, it increases the overall height of the wall cabinet by 4 1/2". It is not necessary to pick both Add Toekick and Flush Toekick to get this look on walls. All doors feature a square door style to match other base cabinets on order.
- Frame opening width on Flush Toekick - Arch, Style B, Style D, Style E, Style H, Style J, Style K, and Style L: minimum: 12", maximum: 57".
- To see images of the styles, see section R (AV**, VV**, V**B, V**D, V**E, V**H, V**J, V**K, V**L).

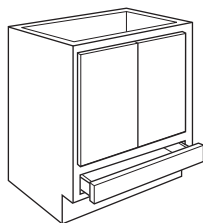

Inverted Frame

0	0	N/A	N/A	N/A	per cabinet
---	---	-----	-----	-----	-------------

Specify INVFRM (Inverted Frame)

Base and 48" to 60" Diagonal Wall cabinets can be ordered with the face frame openings inverted. The Inverted Frame option applies only to an actual exchanging of opening locations, not a re-sizing of any opening. Drawer openings relocated to the bottom of a base must always be a working drawer.

Custom Modifications

Cabinet Box Frame Modifications (cont'd)

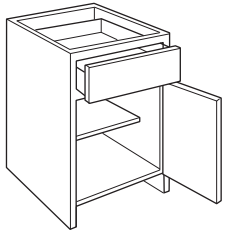

Open Bottom Rail Base

Wall	Base	Tall	Filler	Panel	
0	0	0	N/A	N/A	per cabinet

Specify OBRB (Open Bottom Rail Base)

With this option, the sub-toekick on base and tall cabinets is eliminated and the stiles are extended down 4 1/2", which is the standard toekick height.

- When Open Bottom Rail Base is selected for wall cabinets, it increases the overall height of the wall cabinet by 4 1/2".
- Available in place of Flush Toekick on office units with the open area remaining 3 1/2".
- Maximum frame opening width is 57".

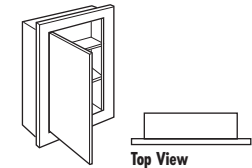

Recessed Vanity Wall

15%	N/A	N/A	N/A	N/A	per cabinet
-----	-----	-----	-----	-----	-------------

Specify REC (Recessed Vanity Wall)

With this option, the standard vanity wall cabinet construction will change to match the construction of the Recessed Vanity Wall cabinets.

- Available on:
 - Vanity Wall Cabinets (W____4) only. See pages P•3-P•4.

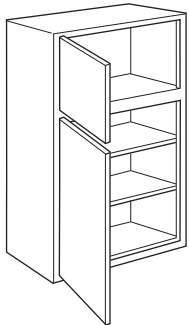

Stacked Wall Cabinet Heights

0	N/A	N/A	N/A	N/A	per cabinet
---	-----	-----	-----	-----	-------------

Specify STW.TOP_ (Stacked Wall Top) or STW.BTM_ (Stacked Wall Bottom)

Stacked wall cabinets can be ordered with different top and bottom "cabinet" heights as long as the total height of the cabinet remains constant. For example, an STW2748 has a top cabinet height of 18" and a bottom cabinet height of 30", stacked as one cabinet. This option will allow flexibility by specifying STW.TOP 12" and STW.BTM 36", where the total height still adds up to 48".

When used in conjunction with the increased/reduced height modification, the specified increase/reduction in height will be applied to the bottom cabinet, in addition to, or as a reduction of, the height specified by the STW.BTM modification. The top cabinet height will remain as specified by the STW.TOP modification.

- The minimum height of the top/bottom cabinet is 12".

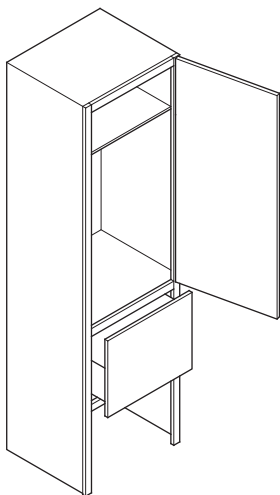

Storage Open Rail Base

N/A	100	100	N/A	N/A	per cabinet
-----	-----	-----	-----	-----	-------------

Specify STORB (Storage Open Rail Base)

With this option, the 4 1/2" sub-toekick on base and tall cabinets is eliminated and the face frame stiles, end panels, and back are extended down the amount specified.

- This option is available in 1/4" increments from 4 3/4" to 18".
- Example: When selecting an EET1878 L or R with the STORB modification of 18", the overall cabinet height will be 91.5". (i.e. 78-4.5+18=91.5)
- See individual cabinets in the Office and Furniture Cabinets section for availability.

Cabinet Box Frame Modifications (cont'd)

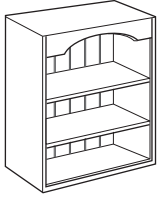

Top Valance Rail

Specify TVRAV (Top Valance Rail - Arch), TVRAVTOP (Top Valance Rail - Arch - Top), TVRAVMID (Top Valance Rail - Arch - Middle), TVRAVBTM (Top Valance Rail - Arch - Bottom), TVRAV.P (Top Valance Rail - Arch - Peninsula), TVRVV (Top Valance Rail - Straight), TVRVVTOP (Top Valance Rail - Straight - Top), TVRVVMID (Top Valance Rail - Straight - Middle), TVRVVBTM (Top Valance Rail - Straight - Bottom), TVRVV.P (Top Valance Rail - Straight - Peninsula), TVRB (Top Valance Rail - Style B), TVRBTOP (Top Valance Rail - Style B - Top), TVRBMID (Top Valance Rail - Style B - Middle), TVRBBTM (Top Valance Rail - Style B - Bottom), TVRB.P (Top Valance Rail - Style B - Peninsula), TVRD (Top Valance Rail - Style D), TVRDTOP (Top Valance Rail - Style D - Top), TVRDMID (Top Valance Rail - Style D - Middle), TVRDBTM (Top Valance Rail - Style D - Bottom), TVRD.P (Top Valance Rail - Style D - Peninsula), TVRE (Top Valance Rail - Style E), TVRETOP (Top Valance Rail - Style E - Top), TVREMID (Top Valance Rail - Style E - Middle), TVREBTM (Top Valance Rail - Style E - Bottom), TVRE.P (Top Valance Rail - Style E - Peninsula), TVRH (Top Valance Rail - Style H), TVRHTOP (Top Valance Rail - Style H - Top), TVRHMID (Top Valance Rail - Style H - Middle), TVRHBTM (Top Valance Rail - Style H - Bottom), TVRH.P (Top Valance Rail - Style H - Peninsula), TVRJ (Top Valance Rail - Style J), TVRJTOP (Top Valance Rail - Style J - Top), TVRJMID (Top Valance Rail - Style J - Middle), TVRJBTM (Top Valance Rail - Style J - Bottom), TVRJ.P (Top Valance Rail - Style J - Peninsula), TVRK (Top Valance Rail - Style K), TVRKTOP (Top Valance Rail - Style K - Top), TVRK MID (Top Valance Rail - Style K - Middle), TVRKBTM (Top Valance Rail - Style K - Bottom), TVRK.P (Top Valance Rail - Style K - Peninsula), TVRL (Top Valance Rail - Style L), TVRLTOP (Top Valance Rail - Style L - Top), TVRLMID (Top Valance Rail - Style L - Middle), TVRLBTM (Top Valance Rail - Style L - Bottom), or TVRL.P (Top Valance Rail - Style L - Peninsula)

Cabinets can be ordered with a valance in place of the standard top rail when the Cabinet No Door option is chosen.

- Must specify Matching Interior, if desired.
- Arch, Style B, Style D, Style E, Style H, Style J, Style K, and Style L not available in Beaded Inset Styles.
- Style B, Style D, Style E, Style H, Style J, Style K, Style L, and Arch valances are not available on cabinets with frame openings less than 12" wide.
- Not available on:
 - Cabinets over 39" wide or units with the Split Doors option.
- Valances are also available as an accessory. See section R (AV**, VV**, V**B, V**D, V**E, V**H, V**J, V**K, V**L).

	Wall	Base	Tall	Filler	Panel	
Arch	0	0	0	N/A	N/A	per cabinet
Straight	0	0	0	N/A	N/A	per cabinet
Style B	0	0	0	N/A	N/A	per cabinet
Style D	0	0	0	N/A	N/A	per cabinet
Style E	0	0	0	N/A	N/A	per cabinet
Style H	0	0	0	N/A	N/A	per cabinet
Style J	0	0	0	N/A	N/A	per cabinet
Style K	0	0	0	N/A	N/A	per cabinet
Style L	0	0	0	N/A	N/A	per cabinet

Custom Modifications

Cabinet Box Frame Modifications (cont'd)

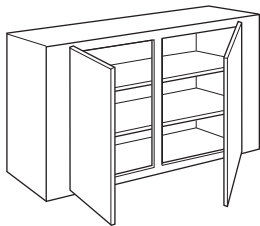

Wide Stiles

Wall	Base	Tall	Filler	Panel	
60	60	60	N/A	N/A	per side

Specify WSL1.5 (Wide Stile Left 1.5"), WSR1.5 (Wide Stile Right 1.5"), WSB1.5 (Wide Stile Left & Right 1.5"), WSL1.5.P (Wide Stile Left Peninsula 1.5"), WSR1.5.P (Wide Stile Right Peninsula 1.5"), WSB1.5.P (Wide Stile Left & Right Peninsula 1.5"), WSL3 (Wide Stile Left 3"), WSR3 (Wide Stile Right 3"), WSB3 (Wide Stile Left & Right 3"), WSL3.P (Wide Stile Left Peninsula 3"), WSR3.P (Wide Stile Right Peninsula 3"), or WSB3.P (Wide Stile Left & Right Peninsula 3")

Wide Stiles can be ordered in 1 1/2" and 3" increments. The Wide Stile 1 1/2" option increases the stile size to 3" overall. The Wide Stile 3" option increases the stile to a total of 4 1/2" wide. The overall back width of the cabinet does not change with this option. The face frame opening is reduced.

- On units with doors and/or drawers, only the Wide Stile 3" can be fluted. On units without doors, the Wide Stile 1 1/2" can be fluted utilizing the standard 1 1/2" end rail as part of the fluting location.
- When IW is used in conjunction with Wide Stiles, then not available with 24" wide Peninsulas, B4D_, B4D_RT, B39RT, B42RT, or B45RT models.
- When IW is used in conjunction with Wide Stiles and it makes the opening 21" wide, then cabinet will have 2 doors.
- Not available on:
 - Clipped Corner.

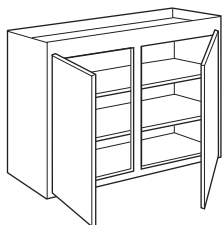

Wide Top Rail

60	60	60	60	60	per cabinet
----	----	----	----	----	-------------

Specify WTR (Wide Top Rail) ____ and fill in the added height dimension required

Most cabinets can have the standard 1 1/2" top rail increased in 1/4" increments up to an additional 3 1/2". Cabinet height increases by the dimension given.

- Ends and backs are extended up with frame. If desired, field modification is possible.
- When Wide Top Rail is specified in conjunction with Integral Ends, the cross rails on the End Panel will not increase to match the extension.
- Authentic Ends are recommended, door size will not increase when Wide Top Rail (WTR) is specified.
- Not available on:
 - 96" high units with Flush Toekick.

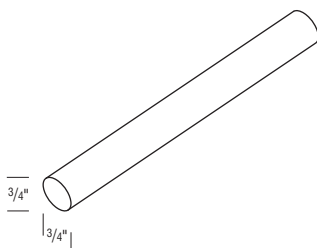

Nickel Towel Bar

140	N/A	N/A	N/A	N/A	per part
-----	-----	-----	-----	-----	----------

TBN

For use with BCTOS and BCTT units only.

End Modifications

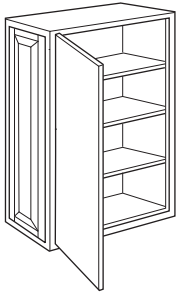

Authentic Flush End

Specify AUTHL (Authentic Flush Left), AUTHR (Authentic Flush Right), or AUTHB (Authentic Flush Left and Right)

	Wall	Base	Tall	Filler	Panel
AUTHB	340	480	952	N/A	35% per end
	340	480	952	N/A	N/A per end

Authentic Flush Ends are available on most cabinets where the look of a working door on the end is desired. The fixed door panel is applied to a finished flush end. Base cabinets have a full height door applied over a finished flush end.

- Finished Flush Ends (5/8" thick) standard only on the side(s) the Authentic Ends are applied.
- On base or tall cabinets, Recessed Toe-kick must be specified if desired.
- If cabinet is over 24" deep, two doors will be applied to end.
- When used in conjunction with the SGLPN modification, the SGLPN logic will be applied changing the tall door to a single center panel.
- Not available on:
 - Inset and Beaded Inset Door Styles.
 - Cabinet backs, and on same side as an Extended Stile.
- See individual cabinets for availability.

Minimum Cabinet Depth for Authentic Ends	Non-Peninsula	Peninsula
Gunther, Karis, Langley, Montgomery, Trystan, Shona	8"	8"
Brooks, Daxton, Caldera, Sumner, Wells, Tackett, Vesta	8 1/2"	8 1/2"

Minimum Cabinet Depth for 3" Clipped Corners	Non-Peninsula	Peninsula	Front & Back
Gunther, Karis, Langley, Montgomery, Trystan, Shona	11"	11"	14"
Brooks, Daxton, Caldera, Sumner, Wells, Tackett, Vesta	11 1/2"	11 1/2"	14 1/2"

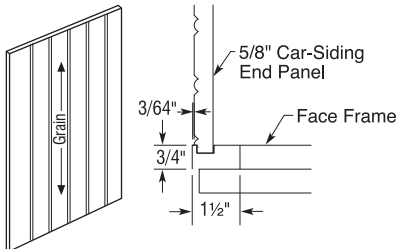

Car Siding Flush Panel End

Specify CSFPEL (Car Siding Flush Panel Left End) or CSFPER (Car Siding Flush Panel Right End)

Cabinets can be ordered with a 5/8" finished veneer end panel to achieve a car siding flush panel end appearance.

- Finished End standard on Car Siding Flush Panel End.
- Not available on heights over 96" high.
- See individual cabinets for availability.

140	200	410	N/A	35%	per end
-----	-----	-----	-----	-----	---------

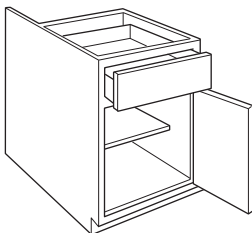

End Extended Back

Specify EXBKL__ (End Extended Back Left) or EXBKR__ (End Extended Back Right) and fill in the amount to be extended

The end panel can be extended back in 1/4" increments up to an additional 12". Finished End must be specified if desired.

- End treatment must be specified (i.e. FL, AUTHL, etc.).
- See individual cabinets for availability.

140	170	200	N/A	N/A	per end
-----	-----	-----	-----	-----	---------

Custom Modifications

End Modifications (cont'd)

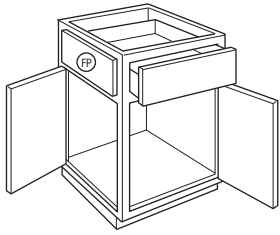

FP False Panel

Wall	Base	Tall	Filler	Panel	
280	410	680	N/A	N/A	per end

Face Frame and Door on End

Specify FFDR.HL (Face Frame and Door on Right End – Hinge Left), FFDR.HR (Face Frame and Door on Right End – Hinge Right), FFDR.HL.FH (Full Height Face Frame and Door on Right End – Hinge Left), FFDR.HR.FH (Full Height Face Frame and Door on Right End – Hinge Right), FFDL.HL (Face Frame and Door on Left End – Hinge Left), FFDL.HR (Face Frame and Door on Left End – Hinge Right), FFDL.HL.FH (Full Height Face Frame and Door on Left End – Hinge Left), or FFDL.HR.FH (Full Height Face Frame and Door on Left End – Hinge Right)

- When a working door is desired on the end of a cabinet, specify Face Frame and Door on End.
- When Face Frame and Door on End is selected on base and tall cabinets, Recessed Toekick is standard.
 - If the Flush Toekick option is selected, then all sides of cabinet will be Flush Toekick.
 - When used in conjunction with the SGLPN modification, the SGLPN logic will be applied changing the tall door to a single center panel.
 - Not available on:
 - Inset and Beaded Inset Door Styles.
 - Both cabinet ends or cabinets with End Extended Back.
 - Peninsula cabinets.
 - See individual cabinets for availability.

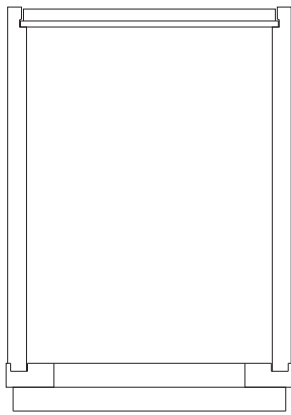

Top View

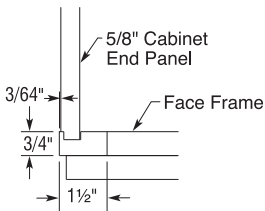

Wall	Base	Tall	Filler	Panel	
140	170	280	N/A	280	per end

Flush Panel End

Specify FPFL (Flush Left End) or FPER (Flush Right End)

- Cabinets can be ordered with a 5/8" finished veneer end panel to achieve a Flush Panel End appearance.
- Finished End standard on Flush Panel End. The other side is unfinished unless a finished end is specified.
 - See individual cabinets for availability.

End Modifications (cont'd)

Wall	Base	Tall	Filler	Panel
410	540	680	N/A	680 per end

Inset Panel Ends

Specify IPEL (Inset Panel End Left) or IPER (Inset Panel End Right)

With this option, the current end panel is replaced with a frame and door that is then applied to a 3/8" end panel.

- Cabinets deeper than 24" will have two butt doors.
- Minimum cabinet depth is 9". Maximum cabinet depth is 30".
- Minimum cabinet height is 12". Maximum cabinet height is 96".
- Cabinets less than 12" deep will utilize a slab door.
- Cabinets with a toekick (Base, Vanity, Office, and Tall Cabinets, as well as Wall Cabinets with ADDTK) will include a Flush Toekick with a notch on the inset panel end frame.
- When Wide Top Rail (WTR) and Bottom Valance Rail (BVR_) is selected the frame on the inset panel end will also have the modification applied.
- When used in conjunction with the SGLPN modification, the SGLPN logic will be applied changing the tall door to a single center panel.
- Available on:
 - Inset and Beaded Inset door styles only.
- Not available with:
 - Aluminum Frame Doors, Modified Full Overlay, End Extended Back, Face Frame and Door on End, Glass Shelf Kits, Wall End & Back Extended Down, or 3" Clipped Corners.

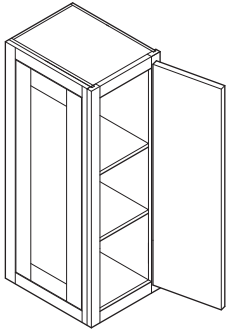

Wall

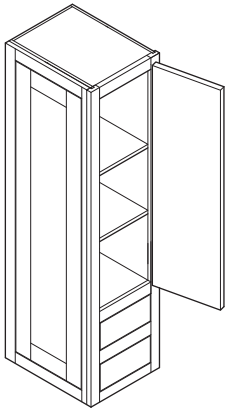

Wall with Added Drawer

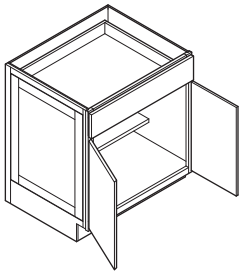

Base

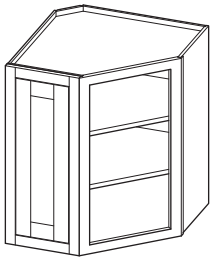

Diagonal

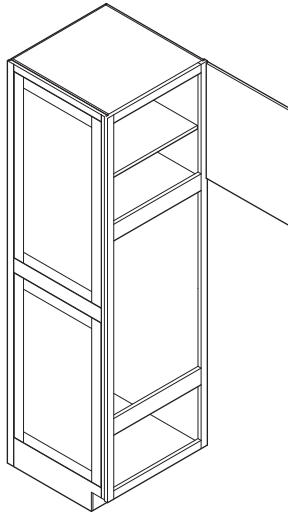

Tall Oven

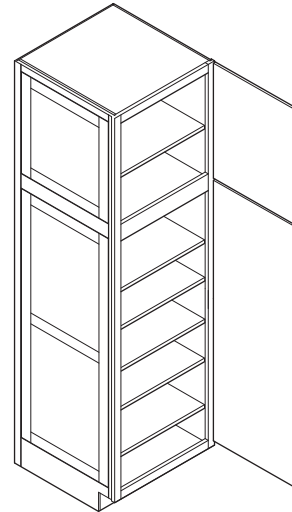

Utility

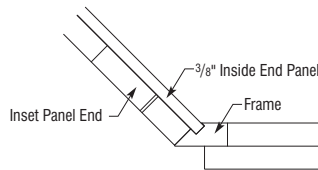
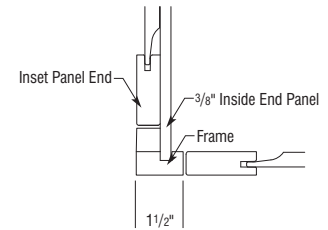

Custom Modifications

End Modifications (cont'd)

Wall	Base	Tall	Filler	Panel	
410	540	680	N/A	680	per end

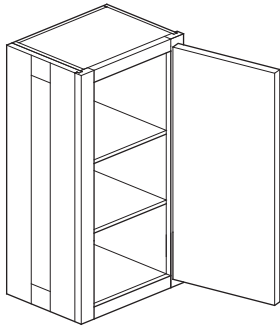

Wall

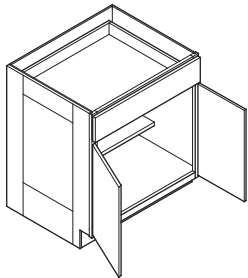

Base

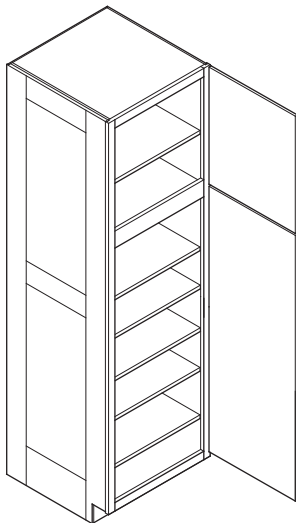

Tall

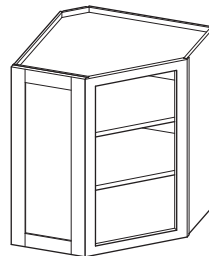
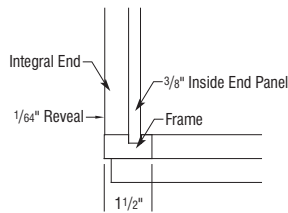

Diagonal

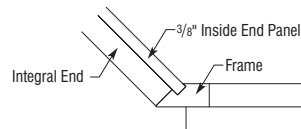

Integral End

Specify **INTGEL** (Integral End Left) or **INTGER** (Integral End Right)

Integral Ends are available on most cabinets where the look of a furniture end is desired. Integral Ends will closely match the door style specified on the order.

- Outside profile will be #12 regardless of door profile.
- On wall cabinets, all rails and stiles are sized to match the selected door styles.
- On base, vanity, and tall cabinets, the bottom rail is always 7" high. Caldera, Gunther, Karis, Langley, Montgomery, and Shona utilize 3 1/2" rails and stiles. Daxton and Sumner utilize 4" rails and stiles.
- Cabinets over 48" will always have 2 equally sized panels in height.
- Cabinets deeper than 24" will have double wide panels.
- Minimum wall cabinet depth is 9".
- Minimum base cabinet depth is 12".
- Minimum cabinet height is 18".
- Not available in conjunction with: Face Frame and Door on End, Glass Shelf Kits, Add Toekick, Toekick Drawer, Toekick Pedestal and Clipped Corner.
- 96" tall cabinets will have Attached Toekick standard. 96" tall cabinets not available with Wide Top Rail.
- When Bottom Valance Rail, Modified Full Overlay or Wide Top Rail is selected in conjunction with Integral End, the cross rail on the Integral End will not increase to match the extension.
- The maximum cut-out for oven cabinets is 3" less than the cabinet width.
- Only available on the following Full Overlay styles:
 - Daxton, Caldera, Gunther, Sumner, Karis, Langley, Montgomery, and Shona.

Wall End and Back Extended Down

140	N/A	N/A	N/A	N/A	per end
-----	-----	-----	-----	-----	---------

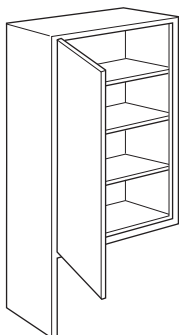

Specify **EXDNL** (Wall End Extended Down Left) or **EXDNR** (Wall End Extended Down Right) and fill in the amount to be extended
 Specify **EXDNLRB** (Back Extended Down) when both right and left ends are extended down and fill in the amount to be extended

The end panel and attached face frame rail can be extended down in 1/4" increments up to an additional 24". When one or both ends are extended down, the interior of the extended ends is skinned to match the cabinet exterior.

- If both the ends and the back are extended down, the cabinet must be Matching Interior.
- When ordering a cabinet with Bottom Valance Rail in conjunction with End Extended Down, overall cabinet height is standard height plus Bottom Valance Rail plus Extended Down.
- Not available on:
 - Cabinets with Face Frame and Door on End and Inset Panel Ends.

Toekick Modifications

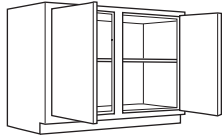

Add Toekick

Specify ADDTK (Add Toekick)

Wall cabinets can be ordered with a 4 1/2" high recessed toekick added. The overall height of the cabinet increases by 4 1/2". All doors feature a square door style to match other base cabinets on order.

Wall	Base	Tall	Filler	Panel	
0	N/A	N/A	N/A	N/A	per cabinet

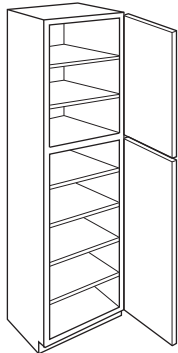

Attach Toekick

Specify ATTK (Attach Toekick)

For cabinets over 93" high, specify Attach Toekick if toekick is desired.

N/A	N/A	0	N/A	N/A	per cabinet
-----	-----	---	-----	-----	-------------

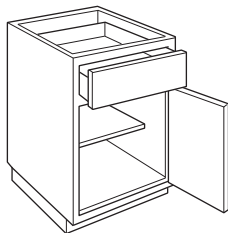

Recessed Toekick

Specify RECTKL (Recessed Left End), RECTKR (Recessed Right End), RECTKBK (Recessed Back), RECTKL.R (Recessed Left and Right Ends), RECTL.BK (Recessed Left and Back Ends), RECTKR.BK (Recessed Right and Back Ends), RECTKL.R.BK (Recessed Left, Right and Back Ends), or RECTKALL (Recessed All Ends)

Cabinets with a toekick are available with recessed toekick on ends and/or back.

- Recessed Toekick standard when Face Frame and Door on End is ordered.
- Not available when:

- Units with Flush Toekick, Open Bottom Rail Base or Toekick Drawer is specified.

0	0	0	N/A	N/A	per side
---	---	---	-----	-----	----------

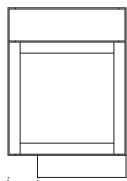

RECTKL6

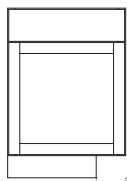

RECTKR6

Recessed Toekick – 6"

Specify RECTKL6 (Recessed Toekick Left - 6"), RECTKR6 (Recessed Toekick Right - 6"), RECTKL.R6 (Recessed Toekick Left and Right - 6"), RECTKBK6 (Recessed Toekick Back - 6"), RECTL.BK6 (Recessed Toekick Left and Back - 6"), RECTKR.BK6 (Recessed Toekick Right and Back - 6"), RECTKL.R.BK6 (Recessed Toekick Left, Right and Back - 6"), RECTKALL6 (Recessed Toekick All - 6"), RECTKFRT.BK6 (Recessed Toekick Front and Back - 6"), RECTKFRT.L6 (Recessed Toekick Front and Left - 6"), RECTKFRT.R6 (Recessed Toekick Front and Right - 6"), RECTKFRT.L.R6 (Recessed Toekick Front, Left and Right - 6"), RECTKFRT.L.BK6 (Recessed Toekick Front, Left and Back - 6"), RECTKFRT.R.BK6 (Recessed Toekick Front, Right and Back - 6")

Cabinets with a toekick are available with 6" recessed toekick on ends, back, and/or front.

- Suggested use with Decorative Feet.
- Available with select Base and Vanity cabinets.

RECTKL6	N/A	166	N/A	N/A	N/A	per cabinet
RECTKR6	N/A	166	N/A	N/A	N/A	per cabinet
RECTKL.R6	N/A	330	N/A	N/A	N/A	per cabinet
RECTKBK6	N/A	166	N/A	N/A	N/A	per cabinet
RECTL.BK6	N/A	330	N/A	N/A	N/A	per cabinet
RECTKR.BK6	N/A	330	N/A	N/A	N/A	per cabinet
RECTKL.R.BK6	N/A	495	N/A	N/A	N/A	per cabinet
RECTKALL6	N/A	666	N/A	N/A	N/A	per cabinet
RECTKFRT.BK6	N/A	330	N/A	N/A	N/A	per cabinet
RECTKFRT.L6	N/A	330	N/A	N/A	N/A	per cabinet
RECTKFRT.R6	N/A	330	N/A	N/A	N/A	per cabinet
RECTKFRT.L.R6	N/A	495	N/A	N/A	N/A	per cabinet
RECTKFRT.L.BK6	N/A	495	N/A	N/A	N/A	per cabinet
RECTKFRT.R.BK6	N/A	495	N/A	N/A	N/A	per cabinet

Custom Modifications

Toekick Modifications (cont'd)

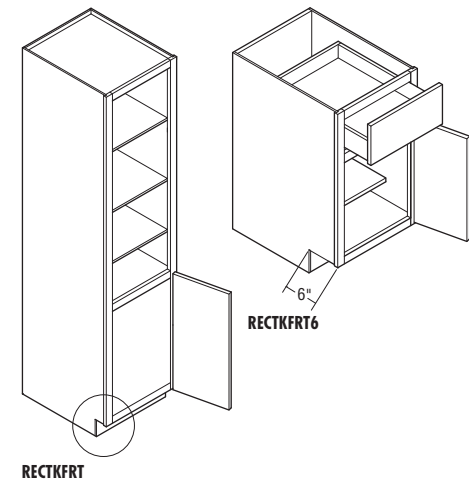

Recessed Toekick Front

Specify RECTKFRT (Recessed Toekick Front) or RECTKFRT6 (Recessed Toekick Front – 6")

With this option, the toekick area is recessed in the front only.

- RECTKFRT Available on:
 - Tall Bookcases (T_BCAV, TD_BCAV, and TDV_BCAV). See pages 0●29-0●40.
- RECTKFRT6 Available on:
 - Select Base and Vanity cabinets.
- RECTKFRT6 is suggested for use with Decorative Feet.

	Wall	Base	Tall	Filler	Panel	
RECTKFRT	N/A	N/A	0	N/A	N/A	per cabinet
RECTKFRT6	N/A	166	N/A	N/A	N/A	per cabinet

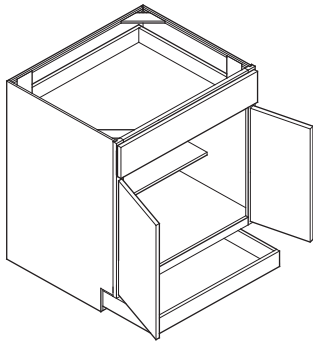

Toekick Drawer

Specify DRWTK (Toekick Drawer)

Cabinets with toekicks are available with a toekick drawer.

- Toekick drawer is push to open.
- Front is unfinished, allow enough toe skin to cover front.
- Available in:
 - 1/4" widths from 15" to 36"
 - 21" and 24" deep
 - Cabinets less than 15" wide
- Not available on:
 - Units with Clipped Corners, Increased or Reduced Depths, Modified Bottom Rails, Modified Toekick, and Inset Panel Ends.
- Smart Stop is standard.

N/A	720	720	N/A	N/A	per cabinet
-----	-----	-----	-----	-----	-------------

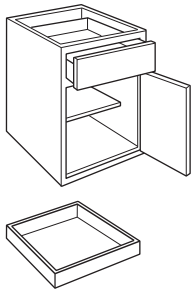

Toekick Pedestal

Specify TKP (Toekick Pedestal)

Specify Toekick Pedestal if toekick unattached from cabinet is desired.

0	0	0	N/A	N/A	per cabinet
---	---	---	-----	-----	-------------

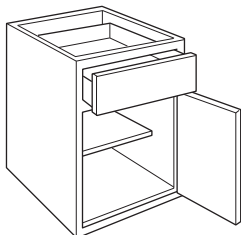

Void Toekick

Specify VTK (Void Toekick)

To reduce the height of the cabinet by 4 1/2" and remove the Recessed Toekick.

N/A	0	0	N/A	N/A	per cabinet
-----	---	---	-----	-----	-------------

Drawer and Roll Tray Modifications

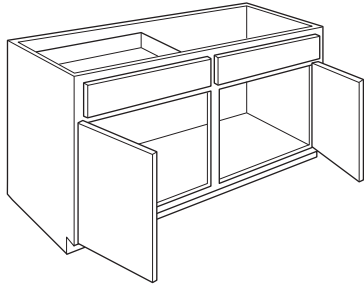

Cabinet False Panel

Wall	Base	Tall	Filler	Panel	
N/A	0	0	N/A	N/A	per cabinet

Specify CFP (Cabinet False Panel), CFPL (Cabinet False Panel Left), CFPR (Cabinet False Panel Right), or CFPB (Cabinet False Panel Both)

Base and vanity cabinets with two side-by-side working drawers can be ordered with cabinet false panels in place of the working drawers.

- Available on:
 - 24" to 39" wide two drawer cabinets

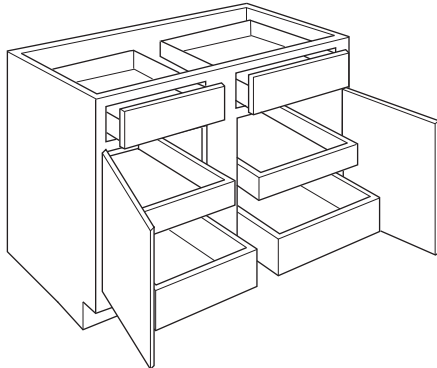

Deep Roll Trays

N/A	140	140	N/A	N/A	per roll tray
-----	-----	-----	-----	-----	---------------

Specify DRT (Deep Roll Tray)

Modification upgrades bottom roll tray only on base cabinets and bottom 2 roll trays on utility cabinets.

- Modification available on standard roll tray cabinets only.
- Largest single full width roll tray is available on a 36" wide cabinet with increased width up to 38 3/4".
- Available on:
 - 12" to 24" deep cabinets in 3" increments
 - 12" to 48" wide cabinets in 1/4" increments
- Not available on:
 - Units with Face Frame and Door on End.
 - Peninsula cabinets.

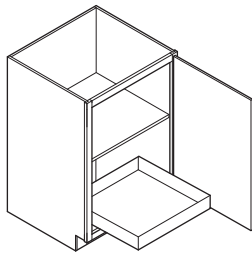

Roll Tray Bottom with Full Depth Shelf

12" to 39"	N/A	325	N/A	N/A	N/A	per cabinet
39 1/4" to 48"	N/A	650	N/A	N/A	N/A	per cabinet

Specify FDSRTBTM (Installed Roll Tray Bottom with Full Depth Shelf)

With this option, a Roll Tray is installed in the bottom of cabinet with a full depth shelf in base cabinets.

- Available on Base Cabinets with Full Height Doors which have a standard full depth shelf.
- Available on Base Cabinets, Base Cabinets with Bread Board, and Base Cabinets with Wood Tiered Cutlery Divider which have a standard half depth shelf that will be replaced with an adjustable full depth shelf.
- Largest single full width roll tray is available on a 39" wide cabinet. 39 1/4" or wider cabinet width will include split doors and a roll tray on both the left and right side of the cabinet.
- Available on:
 - 12" to 24" deep cabinets - roll tray will be in 3" increments
 - 12" to 48" wide cabinets - roll tray will be in 1/4" increments
- Roll Tray width will adjust with cabinet width.
- Not available on:
 - Units with Face Frame and Door on End or Peninsula Cabinets.

Custom Modifications

Drawer and Roll Tray Modifications (cont'd)

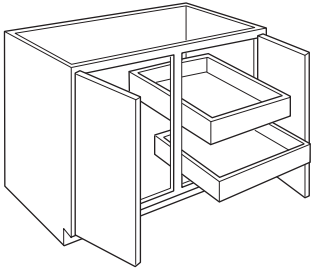

Roll Trays

Specify **_RT** (Installed Roll Tray), **_RTBTM** (Installed Roll Tray - Bottom), **_RTLBTM** (Installed Roll Tray - Left - Bottom), **_RTRBTM** (Installed Roll Tray - Right - Bottom), **_RTL** (Installed Roll Tray - Left), **_RTMID** (Installed Roll Tray - Middle), **_RTLMID** (Installed Roll Tray - Left - Middle), **_RTRMID** (Installed Roll Tray - Right - Middle), **_RTR** (Installed Roll Tray - Right), **_RTTOP** (Installed Roll Tray - Top), **_RTLTOP** (Installed Roll Tray - Left - Top), or **_RTRTOP** (Installed Roll Tray - Right - Top)

With this option, Roll Trays are installed in the cabinet.

- Roll tray width will adjust with cabinet width.
- Roll Tray option substitutes pull-out for standard shelf.
- Largest single full width roll tray is available on a 36" wide cabinet with increased or reduced width up to 38 3/4".
- Specify the number of roll trays between 1 and 5.
- Available on:
 - 12" to 24" deep cabinets - roll tray will be in 3" increments
 - 12" to 48" wide cabinets - roll tray will be in 1/4" increments
- Not available on:
 - Units with Face Frame and Door on End.
 - Peninsula cabinets.

	Wall	Base	Tall	Filler	Panel	
12" to 24" roll trays	265	265	265	N/A	N/A	per roll tray
27" to 36" roll trays	325	325	325	N/A	N/A	per roll tray

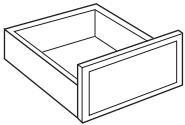

Scooped Drawer

Specify **SCDRW**, **SCDRWL** (Scooped Drawer Left), **SCDRWR** (Scooped Drawer Right), or **SCDRWB** (Scooped Drawer Both)

Cabinets with drawers can be ordered with the top drawer box height reduced to 2" to allow for clearance of cooktops, etc.

- Only top drawer is modified when specified on drawer base units.

	Left or Right	Both				
	N/A	60	N/A	N/A	N/A	per drawer
	N/A	60	N/A	N/A	N/A	per drawer

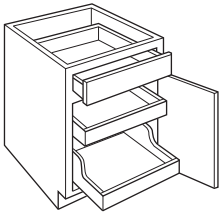

Scooped Roll Tray

Specify **SRT** (Scooped Roll Tray)

With this option, all roll trays in the cabinet are upgraded to scooped roll trays.

- Modification available on standard roll tray cabinets only.
- Largest single full width roll tray is available on a 36" wide cabinet with Increased or Reduced Width up to 38 3/4".
- Available on:
 - 21" or 24" deep cabinets
 - 12" to 48" wide cabinets in 1/4" increments
- Not available on:
 - Units with Face Frame and Door on End.
 - Peninsula cabinets.

N/A	5%	5%	N/A	N/A	per cabinet
-----	----	----	-----	-----	-------------

Drawer and Roll Tray Modifications (cont'd)

Wall	Base	Tall	Filler	Panel
N/A	85	85	N/A	N/A per drawer box

U-SHAPED DRAWER
ON SELECT
BASE CABINETS

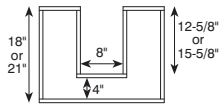

U-shaped Drawer Box

Specify UDBX

- Available on cabinet depths of 21" to 24" in 1/4" increments (18" or 21" box depth).
- Minimum opening width is 21".
- Maximum opening width is 45".
- 8" and 4" dimensions of U-shape stays constant for all drawer box sizes, the legs of U-shape are either 12 5/8" or 15 5/8".
- Available in conjunction with Scooped Drawer.
- Not available with: Any drawer insert or pull-out (CIW, BB, WTCD, etc.).
- Available on the following models:
 - The 1, 2, 3, 4 in the modification code refer to the location of drawer box in cabinet and all drawers above that location will be affected.

Model Description	Model Names	Modification Code	Modification Meaning
Base/vanity models with full width drawer at top	B24 L or R - B39 B24RT L or R - B36RT B24P L or R - B39P VB243221 L or R - VB393221 VB243421 L or R - VB393421	UDBX	U-shaped drawer box
Base models with two side by side top drawers, specify left, right or both	B48, B48RT, B48P VB483221 VB483421	UDBXL UDBXR UDBXB	U-shaped drawer box left U-shaped drawer box right U-shaped drawer box left & right
Base models with two drawers, specify top only or both	B2D24 L or R - B2D36 B2D24RT - B2D36RT	UDBX1 UDBX2	U-shaped drawer box #1 location U-shaped drawer box #1 and #2 location
Base models with four split drawers, specify top left, top & 2nd left, top right, top & 2nd right, top left & top right, all	B4D48 B4D48RT	UDBX1L UDBX2L UDBX1R UDBX2R UDBX1B UDBX2B	U-shaped drawer box #1 location left U-shaped drawer box #1 and #2 location left U-shaped drawer box #1 location right U-shaped drawer box #1 and #2 location right U-shaped drawer box #1 location left & right U-shaped drawer box #1 and #2 location left & right
3DB models, specify top drawer only, top & 2nd only, all	3DB24 - 3DB42 VDB243221 - VDB363221 VDB243421 - VDB363421	UDBX1 UDBX2 UDBX3	U-shaped drawer box #1 location U-shaped drawer box #1 and #2 location U-shaped drawer box #1, #2 and #3 location
4DB models, specify top drawer only, top & 2nd only, top, 2nd & third only, all	4DB24 - 4DB42 4VDB123221 - 4VDB363221 4VDB123421 - 4VDB363421	UDBX1 UDBX2 UDBX3 UDBX4	U-shaped drawer box #1 location U-shaped drawer box #1 and #2 location U-shaped drawer box #1, #2 and #3 location U-shaped drawer box #1, #2, #3 and #4 location
2DB 28.5" high, specify top only or both	2DB2428 - 2DB3628	UDBX1 UDBX2	U-shaped drawer box #1 location U-shaped drawer box #1 and #2 location
Base Pots & Pans	BPPP24 L or R, BPPP24, BPPP30	UDBX	U-shaped drawer box
Base Pots & Pans Storage	B24PS, B30PS, B36PS	UDBX	U-shaped drawer box
Base Lid Organizer	B30RTLO - B36RTLO	UDBX	U-shaped drawer box
Base w/Food Storage Container Organizer	B24FSCO L or R	UDBX	U-shaped drawer box
2 Drawer Drop-in Range Base, specify top only, both	2DB30DR, 2DB36DR	UDBX1 UDBX2	U-shaped drawer box #1 location U-shaped drawer box #1 and #2 location

Custom Modifications

Drawer and Roll Tray Modifications (cont'd)

U-SHAPED DRAWER
ON SELECT
BASE CABINETS

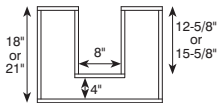

U-shaped Roll Tray

Wall	Base	Tall	Filler	Panel
N/A	85	85	N/A	N/A

Specify URT

- Available on cabinet depths of 21" to 24" in 1/4" increments (18" or 21" box depth).
- Minimum opening width is 21". Minimum opening width on inset cabinet is 24".
- Maximum opening width is 33".
- Dimensions of U-shape stays constant for all roll tray sizes.
- Available in conjunction with Deep Roll Tray option.
- Modification will upgrade all roll trays in cabinet.

Model Description	Model Names	Modification Code	Modification Meaning
Base models w/roll trays	B24RT L or R - B36RT	URT	Both roll trays U-shape
Base models w/roll trays and with two side by side top drawers	B48RT	URTL URTR URTB	Both roll trays on left U-shape Both roll trays on right U-shape Both roll trays on left & right U-shape
Base models w/roll tray and with two drawers	B2D24RT L or R - B2D36RT	URT	Roll tray U-shape
Base models w/roll tray and with four split drawers	B4D48RT	URTL URTR URTB	Roll tray on left U-shape Roll tray on right U-shape Roll tray on left & right U-shape

24" to 36"	Wall	Base	Tall	Filler	Panel
	N/A	355	355	N/A	N/A

- Available on roll trays added as an accessory to the following cabinets. Specify the number of U-shaped roll tray between 1 to 5.

Model Description	Model Names	Modification Code	Modification Meaning
Base Cabinet w/Full Height Doors	B24FH L or R - B36FH, B24FH	URT_	# of U-shaped roll trays added
Sink and Range Base Cabinet	SB24 L or R - SB36, SB24	URT_	# of U-shaped roll trays added
Sink and Range Base Cabinet w/Tilt-out Tray	SB24ST L or R - SB36ST, SB24ST	URT_	# of U-shaped roll trays added
Country Sink Base Cabinet	CNTYSB30 - CNTYSB36	URT_	# of U-shaped roll trays added
Vanity Base Cabinet	VB243221 L or R - VB363221, VB243221 VB243421 L or R - VB363421, VB243421	URT_	# of U-shaped roll trays added
Vanity Base Cabinet w/Full Height Door	V243221S L or R - V363221S, V243221S V243421S L or R - V363421S, V243421S	URT_	# of U-shaped roll trays added
Vanity Sink Base Cabinet	VSB243221 L or R - VSB363221, VSB243221 VSB243421 L or R - VSB363421, VSB243421	URT_	# of U-shaped roll trays added

Wood Top Modifications

Wall	Base	Tall	Filler	Panel
30	30	N/A	N/A	N/A per side

Ordering Information

To clip **ONE** corner, please specify:



Clip Left WTCLIP3L or WTCLIP6L

OR



Clip Right WTCLIP3R or WTCLIP6R

To clip **TWO** corners, please specify:

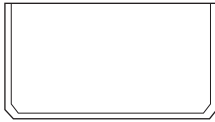

Clip Left and Right WTCLIP3B or WTCLIP6B

OR



Clip Left Sides WTCLIP3LFRT.LBK or WTCLIP6LFRT.LBK

OR



Clip Right Sides WTCLIP3RFRT.RBK or WTCLIP6RFRT.RBK

Clipped Corner Wood Tops

Specify WTCLIP3L (Wood Top Clipped Corner Left), WTCLIP3R (Wood Top Clipped Corner Right), WTCLIP3B (Wood Top Clipped Corner Left & Right), WTCLIP3LFRT.LBK (Wood Top Clipped Corner Left Front & Left Back), WTCLIP3RFRT.RBK (Wood Top Clipped Corner Right Front & Right Back), WTCLIP6L (Wood Top Clipped Corner 6" Left), WTCLIP6R (Wood Top Clipped Corner 6" Right), WTCLIP6B (Wood Top Clipped Corner 6" Left & Right), WTCLIP6LFRT.LBK (Wood Top Clipped Corner 6" Left Front & Left Back), or WTCLIP6RFRT.RBK (Wood Top Clipped Corner 6" Right Front & Right Back)

Wood tops may be ordered with up to two corners "clipped" at a 45° angle. The clipped corner on wood tops will match the clipped corners offered as a cabinet frame modification available in a 3" x 3" clip and 6" x 6" clip. When ordering a Clipped Corner Wood Top, all information as listed under wood top section must be specified, as well as the location of the clipped corners (see ordering information). The wood top is limited to a maximum depth of 48" and maximum length of 96", including the length of the clipped corners.

- All available clipped options shown in drawings.

Custom Modifications

Wood Top Modifications (cont'd)

Wall	Base	Tall	Filler	Panel	
N/A	0	N/A	N/A	N/A	per part



MLDG.FRT (Moulding Front)



MLDG.FRT.BK (Moulding Front & Back)



MLDG.FRT.L (Moulding Front & Left)



MLDG.FRT.L.BK (Moulding Front, Left & Back)



MLDG.FRT.LR (Moulding Front, Left & Right)



MLDG.FRT.R (Moulding Front & Right)



MLDG.FRT.R.BK (Moulding Front, Right & Back)



MLDG.L.R (Moulding Left & Right)



MLDG.ALL (Moulding All)

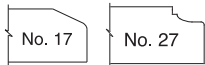
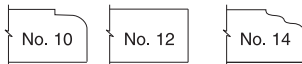

Moulding Location

Specify MLDG.FRT (Moulding Front), MLDG.FRT.BK (Moulding Front & Back), MLDG.FRT.L (Moulding Front & Left), MLDG.FRT.L.BK (Moulding Front, Left & Back), MLDG.FRT.L.R (Moulding Front, Left & Right), MLDG.FRT.R (Moulding Front & Right), MLDG.FRT.R.BK (Moulding Front, Right & Back), MLDG.L.R (Moulding Left & Right), MLDG.ALL (Moulding All), or NOMLDG (No Moulding)

With this option, moulding is added to specified location.

- Edge profile will match door profile selected (#10, #12, #14, #17, #27).
- Glazes and/or Techniques available: F, HW, XHW.

Glazes and Techniques

F = Flooded (see page E•4.)

P = Penned (see page E•4.)

TW = Timeworn (see page E•4.)

XTW = Extra Timeworn (see page E•4.)

HW = Hewn (see page E•4.)

XHW = Extra Hewn (see page E•4.)

General Cabinet Modifications

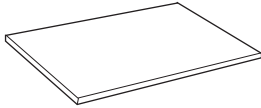

Add Shelf

ADD_SHLF

Wall	Base	Tall	Filler	Panel	
80	140	N/A	N/A	N/A	per shelf

Specify ADD1SHLF (Add Shelf) or ADD2SHLF (Add Two Shelves)

To add a standard shelf in cabinets.

- Wall cabinets must have minimum 21" high opening.

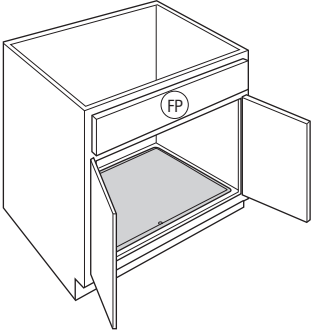

Base cabinets (CMAT1)

CabMat™

CMAT1

CMAT2

N/A	300	N/A	N/A	N/A	per cabinet
N/A	605	N/A	N/A	N/A	per cabinet

Specify CMAT1 (Base Cabinets) or CMAT2 (Vanity Cabinets with Double Bowl)

This option installs removable CabMat™.

- Size is determined by face frame opening width and cabinet depth.
- CMAT1 is available on most 30", 33" and 36" sink base and vanity cabinets.
- CMAT2 is only available on vanity cabinets designed for double bowl applications.
- Not available with Reduced Depth modification.
- When ordered with Increased Depth modification, CabMat™ size does not change.
- Vanity cabinets with face frame openings of 24" and 30" will utilize CabMat™ sized for 21" and 27" openings.
- CabMat™ not available on inset vanity cabinets.
- See page S•13 for CabMat™ product descriptions.

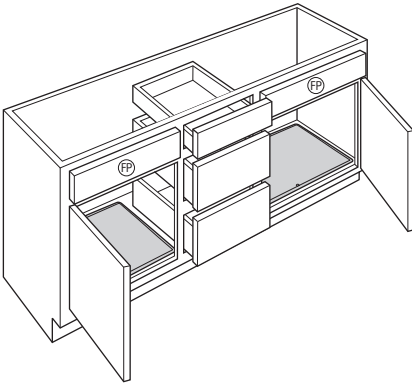

Vanity cabinets with double bowl (CMAT2)

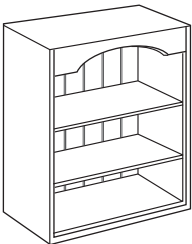

Car Siding Back

280	280	410	N/A	N/A	per cabinet
-----	-----	-----	-----	-----	-------------

Specify CSDGBK (Car Siding Back)

Cabinets that are available as Matching Interior cabinets are available with an installed 3/16" Car Siding Back in the same color as the exterior.

- If the Matching Interior option is not standard on the cabinet, the Matching Interior option must be added to your order.
- If Car Siding interior sides are desired, Car Siding panel must be ordered separately and field installed.
- See individual cabinets for availability.

Custom Modifications

General Cabinet Modifications (cont'd)

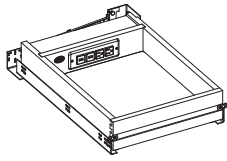

Charging Drawer

	Wall	Base	Tall	Filler	Panel	
CHGDRWB	N/A	1250	N/A	N/A	N/A	per cabinet
	N/A	2500	N/A	N/A	N/A	per cabinet

Specify CHGDRW (Charging Drawer),
CHGDRWL (Charging Drawer Left),
CHGDRWR (Charging Drawer Right), CHGDRWB (Charging Drawer Both)

Select base cabinets can be ordered with the standard top drawer (5" high frame opening) replaced with the CHGDRW.

- Designed for 18" base cabinet drawers.
- Full extension, concealed Smart Stop slides.
- 110 lb. rated.
- 120V outlet must be installed in rear of cabinet within 10" of bottom of drawer, in rear of cabinet.
- CUL US listed power strip with two 120V plugs and two 2.1 amp USB ports.
- Max Current: AC 15 amps @ 120VAC; USB 2.1 amp and 5 VDC each.
- Tamper resistant outlets.
- Power cord with NEMA 5-15 plug.
- Integrated cord guide mounts to cabinet side to ensure safe operation.
- Black, shock absorbing mat included.
- Special sizes not available.
- Only available in 24" deep.
- Available in top drawer(s) only.
- Not available on Inset or Beaded Inset Styles.

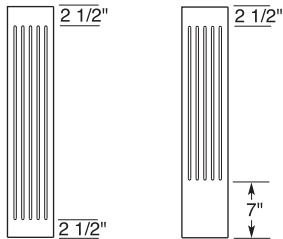

Wall/Base Base with Flush Toe Kick Option

Fluting

3"	50	50	50	N/A	N/A	per part
6"	50	50	50	N/A	N/A	per part

Specify FLUT3L (3" Flute Left), FLUT3R (3" Flute Right),
FLUT3B (3" Flute Both), FLUT3L.P (3" Flute Left - Peninsula), FLUT3R.P (3" Flute Right - Peninsula), FLUT3B.P (3" Flute Both - Peninsula),
FLUT6L (6" Flute Left), FLUT6R (6" Flute Right), FLUT6B (6" Flute Both), FLUT6L.P (6" Flute Left - Peninsula),
FLUT6R.P (6" Flute Right - Peninsula), or FLUT6B.P (6" Flute Both - Peninsula)

With this option, fluting detail is added. Clipped Corners, 3" Extended Stiles, and Wide Stiles may have the Fluting option added.

- Any option that extends the stiles (Bottom Valance Rail, Flush Toe Kick, Open Bottom Rail Base, Top Valance Rail, and Wide Top Rail) do not extend the Flute dimensions.
- Special spacing between flutes not available.
- See individual cabinets for availability.

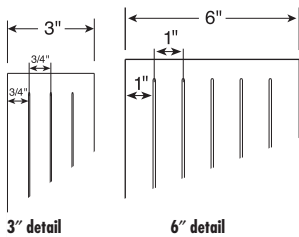
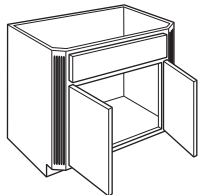

3" detail 6" detail

General Cabinet Modifications (cont'd)

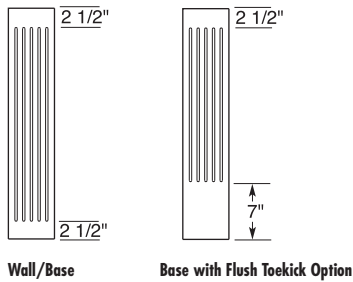

Fluting on Fillers

Specify FLUT3 (3" Fluting on Filler), FLUT6 (6" Fluting on Filler), or FLUT3CTR (6" Filler Fluted 3" on Center)

With this option, fluting detail is added to 3" and 6" fillers.

- Base and Tall End panels with 3" or 6" frame rail return are available with Fluting. Specify Left or Right.
- Special spacing between flutes not available.
- The options Wide Top Rail and Flush Toe Kick do not extend the flute dimensions.
- See individual fillers and panels for availability.

	Wall	Base	Tall	Filler	Panel	
3"	N/A	N/A	N/A	50	50	per part
6"	N/A	N/A	N/A	95	95	per part

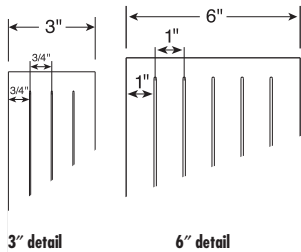

Full Depth Shelf

Specify FD (Full Depth Shelf)

To replace the standard half depth shelf in base cabinets with an adjustable full depth shelf.

- Standard on Base Full, Peninsula Base, Peninsula Base Full, and Vanity Base Full units.

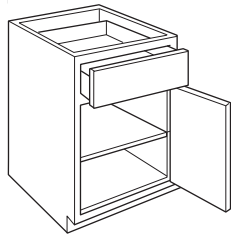

N/A	50	N/A	N/A	N/A	per cabinet
-----	----	-----	-----	-----	-------------

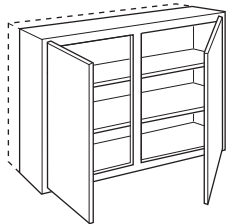

Increased or Reduced Depths

Specify ID_ (Increase Depth) or RD_ (Reduce Depth) and fill in the total required depth of the unit

Increased or Reduced Depths available in 1/4" increments. Limitations are identified throughout the catalog.

- Minimum depth 6", maximum depth 30" on units without drawers or roll trays.
- Minimum depth 12", maximum depth 24" on most units with drawers or roll trays.
- Reducing depth to less than 21" on cabinets with a standard 15" deep shelf, will convert to full depth shelf.

Increased	0	0	0	N/A	0	per cabinet
Reduced	0	0	0	N/A	0	per cabinet

Custom Modifications

General Cabinet Modifications (cont'd)

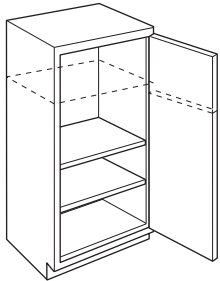

Increased or Reduced Heights

Specify IH_ (Increased Height) or RH_ (Reduce Height)

	Wall	Base	Tall	Filler	Panel
Increased	0	0	N/A	0	0 per cabinet
Reduced	0	0	N/A	0	0 per cabinet

Select cabinets can be ordered with Increased or Reduced Height. Limitations are identified throughout the catalog.

- To achieve desired heights, select the existing cabinet and specify RH or IH along with the new height. For example, to achieve a wall cabinet 18" wide and 18" high, specify W1824 L or R RH18.
- Increased or Reduced Height will increase or decrease the door opening height to achieve the overall desired cabinet height.
- For Wall Cabinets:
 - Increased Heights available in 1/4" increments on select wall cabinets, see the chart below for availability.
 - Reduced Heights available in 1/4" increments on select wall cabinets, see the chart below for availability.
 - For additional information on wall height modifications, please call Customer Service.
- For Base Cabinets:
 - Increased Heights available in 1/4" increments on select base cabinets, see the chart below for availability.
 - Reduced Heights available in 1/4" increments on select base cabinets, see the chart below for availability.
 - For additional information on base height modifications, please call Customer Service.
- For Tall and Oven Cabinets:
 - Increased Heights available in 1/4" increments on select tall and oven cabinets, see the chart below for availability.
 - For additional information on tall and oven cabinet height modifications, please call Customer Service.
- When Increased Height is applied, the B** door opening will be modified, the 3DB** will have height adjustments equally applied to the bottom two drawer openings, the 4DB** will have height adjustments to the bottom drawer, and the 2DB** will have height adjustments added equally to both the drawer openings.

NOTE: Changes to cabinets not listed below will be subject to an upcharge.

Increased or Reduced Heights		
Model	Increased Height Range	Reduced Height Range
2DB18, 2DB21, 2DB24, 2DB27, 2DB30, 2DB33, 2DB36, 2DB39, 2DB42, 2DB45, 2DB48	46 1/2"	30"
2DB18RT, 2DB21RT, 2DB24RT, 2DB27RT, 2DB30RT, 2DB33RT, 2DB36RT	46 1/2"	
2DB30DR, 2DB36DR	46 1/2"	30"
2DB30RDR, 2DB36RDR	46 1/2"	30"
2DB36RTPDO	46 1/2"	
3DB12, 3DB15, 3DB18, 3DB21, 3DB24	46 1/2"	30"
3DB12BB, 3DB15BB, 3DB18BB, 3DB21BB, 3DB24BB	46 1/2"	30"
3DB15WTC, 3DB18WTC, 3DB21WTC, 3DB24WTC, 3DB30WTC, 3DB36WTC	46 1/2"	30"
3DB18KCUP	46 1/2"	30"
3DB27, 3DB30, 3DB33, 3DB36, 3DB39, 3DB42	46 1/2"	30"
4DB12, 4DB15, 4DB18, 4DB21, 4DB24, 4DB27, 4DB30, 4DB33, 4DB36, 4DB39, 4DB42	46 1/2"	32"
4DB12BB, 4DB15BB, 4DB18BB, 4DB21BB, 4DB24BB	46 1/2"	30"
4DB15WTC, 4DB18WTC, 4DB21WTC, 4DB24WTC, 4DB30WTC, 4DB36WTC	46 1/2"	30"
4DB18KCUP	46 1/2"	30"
6DB30, 6DB33, 6DB36, 6DB42	46 1/2"	30"
ACS36 L or R, ACS39 L or R, ACS42	46 1/2"	30"
ACS36ST L or R, ACS39ST L or R, ACS42ST	46 1/2"	30"
ACSF36 L or R, ACSF39 L or R, ACSF42	46 1/2"	30"
AEW2430-45LL, AEWFFD2430-45LL, AEW3630-45LL, AEWFFD3630-45LL	30 1/4" to 32 3/4"	
AEW2430LL, AEWFFD2430LL, AEW3630 L or R, AEWFFD3630 L or R	30 1/4" to 32 3/4"	
AEW2433-45LL, AEWFFD2433-45LL, AEW3633-45LL, AEWFFD3633-45LL	33 1/4" to 35 3/4"	
AEW2433LL, AEWFFD2433LL, AEW3633 L or R, AEWFFD3633 L or R	33 1/4" to 35 3/4"	
AEW2436-45LL, AEWFFD2436-45LL, AEW3636-45LL, AEWFFD3636-45LL	36 1/4" to 38 3/4"	
AEW2436LL, AEWFFD2436LL, AEW3636 L or R, AEWFFD3636 L or R	36 1/4" to 38 3/4"	
AEW2439-45LL, AEWFFD2439-45LL, AEW3639-45LL, AEWFFD3639-45LL	39 1/4" to 41 3/4"	
AEW2439LL, AEWFFD2439LL, AEW3639 L or R, AEWFFD3639 L or R	39 1/4" to 41 3/4"	
AEW2442-45LL, AEWFFD2442-45LL, AEW3642-45LL, AEWFFD3642-45LL	42 1/4" to 48"	
AEW2442LL, AEWFFD2442LL, AEW3642 L or R, AEWFFD3642 L or R	42 1/4" to 48"	
B2D9 L or R, B2D12 L or R, B2D15 L or R, B2D18 L or R, B2D21 L or R, B2D24 L or R, B2D24, B2D27, B2D30, B2D33, B2D36	46 1/2"	30"
B2D12RT L or R, B2D15RT L or R, B2D18RT L or R, B2D21RT L or R, B2D24RT L or R, B2D24RT, B2D27RT, B2D30RT, B2D33RT, B2D36RT	46 1/2"	30"
B4D24, B4D27, B4D30, B4D33, B4D36, B4D39, B4D42, B4D45, B4D48	46 1/2"	30"
B4D24RT, B4D27RT, B4D30RT, B4D33RT, B4D36RT	46 1/2"	30"
B4D39RT, B4D42RT, B4D45RT, B4D48RT	46 1/2"	30"
B6FH L or R, B9FH L or R, B12FH L or R, B15FH L or R, B18FH L or R, B21FH L or R, B24FH L or R, B24FH, BF27, B30FH, B33FH, B36FH, B39FH, B42FH, B45FH, B48FH	46 1/2"	30"
B9 L or R, B12 L or R, B15 L or R, B18 L or R, B21 L or R, B24 L or R, B24, B27, B30, B33, B36, B39, B42, B45, B48	46 1/2"	30"
B9FHP L or R, B12FHP L or R, B15FHP L or R, B18FHP L or R, B21FHP L or R, B24FHP L or R, B24FHP, B27FHP, B30FHP, B33FHP, B36FHP, B39FHP, B42FHP, B45FHP, B48FHP	46 1/2"	30"
B9P L or R, B12P L or R, B15P L or R, B18P L or R, B21P L or R, B24P L or R, B24P, B27P, B30P, B33P, B36P, B39P, B42P, B45P, B48P	46 1/2"	30"
B12BB L or R, B15BB L or R, B18BB L or R, B21BB L or R, B24BB L or R, B24BB, B30BB L or R, B36BB L or R, B42BB L or R, B48BB L or R	46 1/2"	30"
B12RT L or R, B15RT L or R, B18RT L or R, B21RT L or R, B24RT L or R, B24RT, B27RT, B30RT, B33RT, B36RT, B39RT, B42RT, B45RT, B48RT	46 1/2"	30"
B12DRO L or R, B15DRO L or R	46 1/2"	30"
B15PSB L or R, B18PSB L or R	46 1/2"	

General Cabinet Modifications (cont'd)

Increased or Reduced Heights		
Model	Increased Height Range	Reduced Height Range
B15RTWTC L or R, B18RTWTC L or R, B21RTWTC L or R, B24RTWTC L or R, B24RTWTC, B30RTWTC, B36RTWTC	46 1/2"	30"
B15WTC L or R, B18WTC L or R, B21WTC L or R, B24WTC L or R, B24WTC, B30WTC, B36WTC	46 1/2"	30"
B18FSCO L or R, B24FSCO L or R	46 1/2"	
B18KCUP L or R	46 1/2"	30"
B18KCUPRT L or R	46 1/2"	30"
B18SD L or R, B24SD L or R	46 1/2"	30"
B24PS, B30PS, B36PS	46 1/2"	
B30DR, B36DR	46 1/2"	30"
B30RRTDR, B36RRTDR	46 1/2"	30"
B30RTDR, B36RTDR	46 1/2"	30"
B30RTLO, B33RTLO, B36RTLO	46 1/2"	30"
B72SDI	34 3/4" to 46 1/2"	32" to 34 1/4"
B72SDIDSK	34 3/4" to 46 1/2"	32" to 34 1/4"
BAC24	46 1/2"	30"
BAC24FH	46 1/2"	30"
BBS18 L or R	46 1/2"	30"
BC36 L or R, BC39 L or R, BC42 L or R, BC45 L or R, BC48 L or R	34 3/4" to 46 1/2"	30" to 34 1/4"
BC45PO L or R, BC48PO L or R	34 3/4" to 46 1/2"	
BCC30BB L or R, BCC36BB L or R, BCC42BB L or R, BCC48BB	46 1/2"	30"
BCD30 L or R, BCD36 L or R, BCD42 L or R, BCD48 L or R	46 1/2"	30"
BCFW2D48CRVPO L or R	46 1/2"	
BCFW36 L or R, BCFW39 L or R, BCFW42 L or R, BCFW45 L or R, BCFW48 L or R	46 1/2"	30"
BCFW36FH L or R, BCFW39FH L or R, BCFW42FH L or R, BCFW45FH L or R, BCFW48FH L or R	34 3/4" to 46 1/2"	24" to 34 1/4"
BCFW39P L or R, BCFW42P L or R, BCFW48P L or R	46 1/2"	30"
BCFW45CPO L or R, BCFW48CPO L or R	46 1/2"	
BCFW45PO L or R, BCFW48PO L or R	46 1/2"	
BCFW48SP L or R	34 3/4" to 46 1/2"	
BCFWFH45CPO L or R, BCFWFH48CPO L or R	46 1/2"	
BCFWFH48CRVPO L or R	46 1/2"	
BCP27	46 1/2"	30"
BEC24	46 1/2"	30"
BEC24FP	46 1/2"	30"
BER3336 L or R	46 1/2"	30"
BER36RS L or R	46 1/2"	30"
BFH6COA, BFH9COA, BFH12COA	46 1/2"	30"
BFH21CIA, BFH24CIA, BFH27CIA	46 1/2"	30"
BPPP24 L or R, BPPP24, BPPP30	46 1/2"	
BRDB36 L or R	46 1/2"	30"
BTC12LL	46 1/2"	30"
BWB15, BWB18, BWB21, BWB24	46 1/2"	
BWB152	34 3/4" to 46 1/2"	
BWB15BB, BWB18BB, BWB21BB, BWB24BB	46 1/2"	
BWB15FH, BWB18FH, BWB21FH, BWB24FH	46 1/2"	
BWB15FH2, BWB18FH2	34 3/4" to 46 1/2"	
BWB15FHRT2, BWB18FHRT2	34 3/4" to 46 1/2"	
BWB15WTC, BWB18WTC, BWB21WTC, BWB24WTC	46 1/2"	
BWB18KCUP	46 1/2"	
CNTYSB30, CNTYSB33, CNTYSB36, CNTYSB39, CNTYSB42, CNTYSB25, CNTYSB48	46 1/2"	30"
CS36 L or R	46 1/2"	30"
DAB33FS L or R, DAB36FS L or R	46 1/2"	30"
DAB33SLS L or R, DAB36SLS L or R	46 1/2"	30"
DAB36 L or R	46 1/2"	30"
DFD153021, DFD183021, DFD213021, DFD243021	34 1/4"	30"
DFD153421, DFD183421, DFD213421, DFD243421	46 1/2"	
DW182424 L or R, DW182727 L or R	18 1/4" to 23 3/4"	12" to 17 3/4"
DW242424 L or R, DW242727 L or R	24 1/4" to 29 3/4"	
DW302424 L or R, DW302727 L or R	30 1/4" to 32 3/4"	
DW332424 L or R, DW332727 L or R	33 1/4" to 35 3/4"	
DW362424 L or R, DW362727 L or R	36 1/4" to 38 3/4"	
DW392424 L or R, DW392727 L or R	39 1/4" to 41 3/4"	
DW422424 L or R, DW422727 L or R	42 1/4" to 44 3/4"	
DW452424 L or R, DW452727 L or R	45 1/4" to 47 3/4"	
DW302424AG L or R, DW302727AG L or R	48 1/4" to 50 3/4"	

General Cabinet Modifications (cont'd)

Increased or Reduced Heights		
Model	Increased Height Range	Reduced Height Range
DW332424AG L or R, DW332727AG L or R	51 1/4" to 53 3/4"	
DW362424AG L or R, DW362727AG L or R	54 1/4" to 56 3/4"	
DW392424AG L or R, DW392727AG L or R	57 1/4" to 59 3/4"	
DW422424AG L or R, DW422727AG L or R	60 1/4" to 66"	
DW302424D L or R, DW302727D L or R	48 1/4" to 53 3/4"	
DW362424D L or R, DW362727D L or R	54 1/4" to 59 3/4"	
DW422424D L or R, DW422727D L or R	60 1/4" to 66"	
DW482424FH L or R, DW482727FH L or R	48 1/4" to 54"	
DW302424PLL	30 1/4" to 32 3/4"	24" to 29 3/4"
DW332424PLL	33 1/4" to 35 3/4"	
DW362424PLL	36 1/4" to 38 3/4"	
DW392424PLL	39 1/4" to 41 3/4"	
DW422424PLL	42 1/4" to 44 3/4"	
DW452424PLL	45 1/4" to 47 3/4"	
DW482424PLL	48 1/4" to 54"	
ER302121 L or R, ER302124 L or R, ER302421 L or R	30 1/4" to 32 3/4"	18" to 29 3/4"
ER33 L or R	30 1/4" to 32 3/4"	
ER332121 L or R, ER332124 L or R, ER332421 L or R	33 1/4" to 35 3/4"	
ER362121 L or R, ER362124 L or R, ER362421 L or R	36 1/4" to 38 3/4"	
ER392121 L or R, ER392124 L or R, ER392421 L or R	39 1/4" to 41 3/4"	
ER422121 L or R, ER422124 L or R, ER422421 L or R	42 1/4" to 48"	
FD1506.7524, FD1806.7524, FD2106.7524, FD2406.7524, FD2706.7524, FD3006.7524, FD3306.7524, FD3606.7524, FD3906.7524, FD4206.7524, FD4506.7524, FD4806.7524	7" to 11 3/4"	
FD151224, FD181224, FD211224, FD241224, FD271224, FD301224, FD331224, FD361224, FD391224, FD421224, FD451224, FD481224	12 1/4" to 18"	
FDWB151824, FDWB181824, FDWB211824, FDWB241824, FDWB271824, FDWB301824, FDWB331824, FDWB361824, FDWB391824, FDWB421824, FDWB451824, FDWB481824	18 1/4" to 22 1/2"	12" to 17 3/4"
HB30, HB36, HB42, HB48	46 1/2"	30"
LSP36 L or R	46 1/2"	30"
MW2718, MW3018	18 1/4" to 20 3/4"	
OCD278424, OCD308424, OCD338424, OCD368424, OCD398424	84" to 86 3/4"	
OCD278724, OCD308724, OCD338724, OCD368724, OCD398724	87" to 89 3/4"	
OCD279024, OCD309024, OCD339024, OCD369024, OCD399024	90" to 92 3/4"	
OCD279324, OCD309324, OCD339324, OCD369324, OCD399324	93" to 95 3/4"	
OCD2710224AC, OCD3010224AC, OCD3310224AC, OCD3610224AC, OCD3910224AC	102 1/4" to 107 3/4"	96 1/4" to 101 3/4"
OCD278424DD, OCD308424DD, OCD338424DD, OCD368424DD, OCD398424DD	84 1/4" to 86 3/4"	
OCD278724DD, OCD308724DD, OCD338724DD, OCD368724DD, OCD398724DD	87 1/4" to 89 3/4"	
OCD279024DD, OCD309024DD, OCD339024DD, OCD369024DD, OCD399024DD	90 1/4" to 92 3/4"	
OCD279324DDAH, OCD309324DDAH, OCD339324DDAH, OCD369324DDAH, OCD399324DDAH	93 1/4" to 95 3/4"	
OCM278424, OCM308424, OCM338424, OCM368424, OCM398424	84" to 86 3/4"	
OCM278724, OCM308724, OCM338724, OCM368724, OCM398724	87" to 89 3/4"	
OCM279024, OCM309024, OCM339024, OCM369024, OCM399024	90" to 92 3/4"	
OCM279324, OCM309324, OCM339324, OCM369324, OCM399324	93" to 95 3/4"	
OCM2710224AC, OCM3010224AC, OCM3310224AC, OCM3610224AC, OCM3910224AC	102 1/4" to 107 3/4"	96 1/4" to 101 3/4"
OCS278424, OCS308424, OCS338424, OCS368424, OCS398424	84" to 86 3/4"	
OCS278724, OCS308724, OCS338724, OCS368724, OCS398724	87" to 89 3/4"	
OCS279024, OCS309024, OCS339024, OCS369024, OCS399024	90" to 92 3/4"	
OCS279324, OCS309324, OCS339324, OCS369324, OCS399324	93" to 95 3/4"	
OCS2710224AC, OCS3010224AC, OCS3310224AC, OCS3610224AC, OCS3910224AC	102 1/4" to 107 3/4"	96 1/4" to 101 3/4"
OCS278424DD, OCS308424DD, OCS338424DD, OCS368424DD, OCS398424DD	84 1/4" to 86 3/4"	
OCS278724DD, OCS308724DD, OCS338724DD, OCS368724DD, OCS398724DD	87 1/4" to 89 3/4"	
OCS279024DDAH, OCS309024DDAH, OCS339024DDAH, OCS369024DDAH, OCS399024DDAH	90 1/4" to 92 3/4"	
OCS279324DDAH, OCS309324DDAH, OCS339324DDAH, OCS369324DDAH, OCS399324DDAH	93 1/4" to 95 3/4"	
OCS2710224AC, OCS3010224AC, OCS3310224AC, OCS3610224AC, OCS3910224AC	102 1/4" to 107 3/4"	96 1/4" to 101 3/4"
OCS278424, OCS308424, OCS338424, OCS368424, OCS398424	84" to 86 3/4"	
OCS278724, OCS308724, OCS338724, OCS368724, OCS398724	87" to 89 3/4"	
OCS279024, OCS309024, OCS339024, OCS369024, OCS399024	90" to 92 3/4"	
OCS279324, OCS309324, OCS339324, OCS369324, OCS399324	93" to 95 3/4"	
OCS2710224AC, OCS3010224AC, OCS3310224AC, OCS3610224AC, OCS3910224AC	102 1/4" to 107 3/4"	96 1/4" to 101 3/4"
OMC278424, OMC308424, OMC338424, OMC368424, OMC398424	84" to 86 3/4"	
OMC278724, OMC308724, OMC338724, OMC368724, OMC398724	87" to 89 3/4"	

General Cabinet Modifications (cont'd)

Increased or Reduced Heights		
Model	Increased Height Range	Reduced Height Range
OMC279024, OMC309024, OMC339024, OMC369024, OMC399024	90" to 92 3/4"	
OMC279324, OMC309324, OMC339324, OMC369324, OMC399324	93" to 95 3/4"	
OMC2710224AC, OMC3010224AC, OMC3310224AC, OMC3610224AC, OMC3910224AC	102 1/4" to 107 3/4"	96 1/4" to 101 3/4"
OMC278424DD, OMC308424DD, OMC338424DD, OMC368424DD, OMC398424DD	84 1/4" to 86 3/4"	
OMC278724DD, OMC308724DD, OMC338724DD, OMC368724DD, OMC398724DD	87 1/4" to 89 3/4"	
OMC279024DD, OMC309024DD, OMC339024DD, OMC369024DD, OMC399024DD	90 1/4" to 92 3/4"	
OMC279324DDAH, OMC309324DDAH, OMC339324DDAH, OMC369324DDAH, OMC399324DDAH	93 1/4" to 95 3/4"	
PY368424	84" to 86 3/4"	
PY368724	87" to 89 3/4"	
PY369024	90" to 92 3/4"	
PY369324	93" to 95 3/4"	
PY3610224	102 1/4" to 107 3/4"	96 1/4" to 101 3/4"
SB18 L or R, SB21 L or R, SB24 L or R, SB24, SB27, SB30, SB33, SB36, SB39, SB42, SB45, SB48	46 1/2"	30"
SB18ST L or R, SB21ST L or R, SB24ST L or R	46 1/2"	30"
SB24ST, SB27ST, SB30ST, SB33ST, SB36ST, SB39ST, SB42ST, SB45ST, SB48ST	46 1/2"	30"
SF18 L or R	46 1/2"	30"
SF24, SF30, SF36	46 1/2"	30"
SLS3336 L or R, SLS36 L or R	46 1/2"	30"
SLS3R3336 L or R, SLS3R36 L or R	46 1/2"	30"
SLS3R33RS L or R, SLS3R36RS L or R	46 1/2"	30"
SLS3R36CD L or R	46 1/2"	30"
STW_36 L or R, STW2436	36 1/4" to 38 3/4"	
STW_39 L or R, STW2439	39 1/4" to 41 3/4"	
STW_42 L or R, STW2442	42 1/4" to 44 3/4"	
STW_45 L or R, STW2445	45 1/4" to 47 3/4"	
STW_48 L or R, STW2448	48 1/4" to 50 3/4"	
STW_51 L or R, STW2451	51 1/4" to 53 3/4"	
STW_54 L or R, STW2454	54 1/4" to 56 3/4"	
STW_57 L or R, STW2457	57 1/4" to 59 3/4"	
STW_60 L or R, STW2460	60 1/4" to 66"	
STWAG_36 L or R, STWAG2436, STWDAG_36 L or R, STWDAG2436	36 1/4" to 38 3/4"	
STWAG_39 L or R, STWAG2439, STWDAG_39 L or R, STWDAG2439	39 1/4" to 41 3/4"	
STWAG_42 L or R, STWAG2442, STWDAG_42 L or R, STWDAG2442	42 1/4" to 44 3/4"	
STWAG_45 L or R, STWAG2445, STWDAG_45 L or R, STWDAG2445	45 1/4" to 47 3/4"	
STWAG_48 L or R, STWAG2448, STWDAG_48 L or R, STWDAG2448	48 1/4" to 50 3/4"	
STWAG_51 L or R, STWAG2451, STWDAG_51 L or R, STWDAG2451	51 1/4" to 53 3/4"	
STWAG_54 L or R, STWAG2454, STWDAG_54 L or R, STWDAG2454	54 1/4" to 56 3/4"	
STWAG_57 L or R, STWAG2457, STWDAG_57 L or R, STWDAG2457	57 1/4" to 59 3/4"	
STWAG_60 L or R, STWAG2460, STWDAG_60 L or R, STWDAG2460	60 1/4" to 66"	
STWEC1236D, STWEC1236 L or R, STWTC1236LL	36 1/4" to 38 3/4"	
STWEC1239D, STWEC1239 L or R, STWTC1239LL	39 1/4" to 41 3/4"	
STWEC1242D, STWEC1242 L or R, STWTC1242LL	42 1/4" to 44 3/4"	
STWEC1245D, STWEC1245 L or R, STWTC1245LL	45 1/4" to 47 3/4"	
STWEC1248D, STWEC1248 L or R, STWTC1248LL	48 1/4" to 50 3/4"	
STWEC1251D, STWEC1251 L or R, STWTC1251LL	51 1/4" to 53 3/4"	
STWEC1254D, STWEC1254 L or R, STWTC1254LL	54 1/4" to 56 3/4"	
STWEC1257D, STWEC1257 L or R, STWTC1257LL	57 1/4" to 59 3/4"	
STWEC1260D, STWEC1260 L or R, STWTC1260LL	60 1/4" to 66"	
TD6FH L or R, TD9FH L or R, TD12FH L or R, TD15FH L or R, TD18FH L or R	46 1/2"	30"
TD9 L or R, TD12 L or R	46 1/2"	30"
TPP98424 L or R, TPP128424 L or R, TPP158424 L or R, TPP188424 L or R	84" to 86 3/4"	
TPP98724 L or R, TPP128724 L or R, TPP158724 L or R, TPP188724 L or R	87" to 89 3/4"	
TPP99024AH L or R, TPP129024AH L or R, TPP159024AH L or R, TPP189024AH L or R	90" to 92 3/4"	
TPP99324AH L or R, TPP129324AH L or R, TPP159324AH L or R, TPP189324AH L or R	93" to 95 3/4"	
TPP910224 L or R, TPP1210224 L or R, TPP1510224 L or R, TPP1810224 L or R	102 1/4" to 107 3/4"	96 1/4" to 101 3/4"
U3D128424 L or R, U3D158424 L or R, U3D188424 L or R, U3D218424 L or R, U3D248424 L or R	84" to 86 3/4"	
U3D128724 L or R, U3D158724 L or R, U3D188724 L or R, U3D218724 L or R, U3D248724 L or R	87" to 89 3/4"	
U3D129024 L or R, U3D159024 L or R, U3D189024 L or R, U3D219024 L or R, U3D249024 L or R	90" to 92 3/4"	
U3D129324 L or R, U3D159324 L or R, U3D189324 L or R, U3D219324 L or R, U3D249324 L or R	93" to 95 3/4"	

General Cabinet Modifications (cont'd)

Increased or Reduced Heights		
Model	Increased Height Range	Reduced Height Range
U3D248424, U3D278424, U3D308424, U3D338424, U3D368424	84" to 86 3/4"	
U3D248724, U3D278724, U3D308724, U3D338724, U3D368724	87" to 89 3/4"	
U3D249024, U3D279024, U3D309024, U3D339024, U3D369024	90" to 92 3/4"	
U3D249324, U3D279324, U3D309324, U3D339324, U3D369324	93" to 95 3/4"	
U4D128424 L or R, U4D158424 L or R, U4D188424 L or R, U4D218424 L or R, U4D248424 L or R	84" to 86 3/4"	
U4D128724 L or R, U4D158724 L or R, U4D188724 L or R, U4D218724 L or R, U4D248724 L or R	87" to 89 3/4"	
U4D129024 L or R, U4D159024 L or R, U4D189024 L or R, U4D219024 L or R, U4D249024 L or R	90" to 92 3/4"	
U4D129324 L or R, U4D159324 L or R, U4D189324 L or R, U4D219324 L or R, U4D249324 L or R	93" to 95 3/4"	
U4D248424, U4D278424, U4D308424, U4D338424, U4D368424	84" to 86 3/4"	
U4D248724, U4D278724, U4D308724, U4D338724, U4D368724	87" to 89 3/4"	
U4D249024, U4D279024, U4D309024, U4D339024, U4D369024	90" to 92 3/4"	
U4D249324, U4D279324, U4D309324, U4D339324, U4D369324	93" to 95 3/4"	
U128412 L or R, U158412 L or R, U188412 L or R, U218412 L or R, U248412 L or R	84" to 86 3/4"	
U128712 L or R, U158712 L or R, U188712 L or R, U218712 L or R, U248712 L or R	87" to 89 3/4"	
U129012 L or R, U159012 L or R, U189012 L or R, U219012 L or R, U249012 L or R	90" to 92 3/4"	
U129312 L or R, U159312 L or R, U189312 L or R, U219312 L or R, U249312 L or R	93" to 95 3/4"	
U1210212 L or R, U1510212 L or R, U1810212 L or R, U2110212 L or R, U2410212 L or R	102 1/4" to 107 3/4"	96 1/4" to 101 3/4"
U128424 L or R, U158424 L or R, U188424 L or R, U218424 L or R, U248424 L or R	84" to 86 3/4"	
U128724 L or R, U158724 L or R, U188724 L or R, U218724 L or R, U248724 L or R	87" to 89 3/4"	
U129024 L or R, U159024 L or R, U189024 L or R, U219024 L or R, U249024 L or R	90" to 92 3/4"	
U129324 L or R, U159324 L or R, U189324 L or R, U219324 L or R, U249324 L or R	93" to 95 3/4"	
U1210224 L or R, U1510224 L or R, U1810224 L or R, U2110224 L or R, U2410224 L or R	102 1/4" to 107 3/4"	96 1/4" to 101 3/4"
U248412, U278412, U308412, U338412, U368412	84" to 86 3/4"	
U248712, U278712, U308712, U338712, U368712	87" to 89 3/4"	
U249012, U279012, U309012, U339012, U369012	90" to 92 3/4"	
U249312, U279312, U309312, U339312, U369312	93" to 95 3/4"	
U2410212, U2710212, U3010212, U3310212, U3610212	102 1/4" to 107 3/4"	96 1/4" to 101 3/4"
U248424, U278424, U308424, U338424, U368424	84" to 86 3/4"	
U248724, U278724, U308724, U338724, U368724	87" to 89 3/4"	
U249024, U279024, U309024, U339024, U369024	90" to 92 3/4"	
U249324, U279324, U309324, U339324, U369324	93" to 95 3/4"	
U2410224, U2710224, U3010224, U3310224, U3610224	102 1/4" to 107 3/4"	96 1/4" to 101 3/4"
U158424RT L or R, U188424RT L or R, U218424RT L or R, U248424RT L or R	84" to 86 3/4"	
U158724RT L or R, U188724RT L or R, U218724RT L or R, U248724RT L or R	87" to 89 3/4"	
U159024RT L or R, U189024RT L or R, U219024RT L or R, U249024RT L or R	90" to 92 3/4"	
U159324RT L or R, U189324RT L or R, U219324RT L or R, U249324RT L or R	93" to 95 3/4"	
U1510224RT L or R, U1810224RT L or R, U2110224RT L or R, U2410224RT L or R	102 1/4" to 107 3/4"	96 1/4" to 101 3/4"
U248424RT, U278424RT, U308424RT, U338424RT, U368424RT	84" to 86 3/4"	
U248724RT, U278724RT, U308724RT, U338724RT, U368724RT	87" to 89 3/4"	
U249024RT, U279024RT, U309024RT, U339024RT, U369024RT	90" to 92 3/4"	
U249324RT, U279324RT, U309324RT, U339324RT, U369324RT	93" to 95 3/4"	
U2410224RT, U2710224RT, U3010224RT, U3310224RT, U3610224RT	102 1/4" to 107 3/4"	96 1/4" to 101 3/4"
UCD1521, UCD1821, UCD2121, UCD2421, UCD2721, UCD3021, UCD3321, UCD3621	5 1/4" to 6 1/2"	
U1128424 L or R, U1158424 L or R, U1188424 L or R, U1218424 L or R, U1248424 L or R	84" to 86 3/4"	
U1128724 L or R, U1158724 L or R, U1188724 L or R, U1218724 L or R, U1248724 L or R	87" to 89 3/4"	
U1129024 L or R, U1159024 L or R, U1189024 L or R, U1219024 L or R, U1249024 L or R	90" to 92 3/4"	
U1129324 L or R, U1159324 L or R, U1189324 L or R, U1219324 L or R, U1249324 L or R	93" to 95 3/4"	
U11210224 L or R, U11510224 L or R, U11810224 L or R, U12110224 L or R, U12410224 L or R	102 1/4" to 107 3/4"	96 1/4" to 101 3/4"
UOC24846 L or R	84" to 86 3/4"	
UOC24876 L or R	87" to 89 3/4"	
UOC24906 L or R	90" to 92 3/4"	
UOC24936 L or R	93" to 95 3/4"	
UOC241026 L or R	102 1/4" to 107 3/4"	96 1/4" to 101 3/4"
UOC24846	84" to 86 3/4"	
UOC24876	87" to 89 3/4"	
UOC24906	90" to 92 3/4"	
UOC24936	93" to 95 3/4"	
UOC241026	102 1/4" to 107 3/4"	96 1/4" to 101 3/4"
UOC24849 L or R	84" to 86 3/4"	
UOC24879 L or R	87" to 89 3/4"	
UOC24909 L or R	90" to 92 3/4"	
UOC24939 L or R	93" to 95 3/4"	

General Cabinet Modifications (cont'd)

Increased or Reduced Heights		
Model	Increased Height Range	Reduced Height Range
UOC241029 L or R	102 1/4" to 107 3/4"	96 1/4" to 101 3/4"
UOC24849	84" to 86 3/4"	
UOC24879	87" to 89 3/4"	
UOC24909	90" to 92 3/4"	
UOC24939	93" to 95 3/4"	
UOC241029	102 1/4" to 107 3/4"	96 1/4" to 101 3/4"
UOCDZ24849	84" to 86 3/4"	
UOCDZ24879	87" to 89 3/4"	
UOCDZ24909	90" to 92 3/4"	
UOCDZ24939	93" to 95 3/4"	
UOCDZ241029	102 1/4" to 107 3/4"	96 1/4" to 101 3/4"
W_12, W2412	12 1/4" to 14 3/4"	
W_15, W2415	15 1/4" to 17 3/4"	
W_18, W2418	18 1/4" to 20 3/4"	
W_27, W2427	27 1/4" to 29 3/4"	
W_30, W2430	30 1/4" to 32 3/4"	
W_33, W2433	33 1/4" to 35 3/4"	
W_36, W2436	36 1/4" to 38 3/4"	
W_39, W2439	39 1/4" to 41 3/4"	
W_42, W2442	42 1/4" to 44 3/4"	
W_45, W2445	45 1/4" to 47 3/4"	
W_48, W2448	48 1/4" to 54"	
W_18P L or R, W2418P	18 1/4" to 23 3/4"	12" to 17 3/4"
W_24P L or R, W2424P	24 1/4" to 29 3/4"	
W_30P L or R, W2430P	30 1/4" to 35 3/4"	
W_36P L or R, W2436P	36 1/4" to 42"	
W921 L or R, W2421	21 1/4" to 23 3/4"	
W924 L or R, W2424	24 1/4" to 26 3/4"	
W241824 L or R	18 1/4" to 20 3/4"	
W242124 L or R	21 1/4" to 23 3/4"	
W242424 L or R	24 1/4" to 26 3/4"	
W241224, W271224, W301224, W331224, W341224, W361224, W371224, W391224, W421224, W451224	12 1/4" to 14 3/4"	
W241524, W271524, W301524, W331524, W341524, W361524, W371524, W391524, W421524, W451524, W481524	15 1/4" to 17 3/4"	
W241824, W271824, W301824, W331824, W341824, W361824, W371824, W391824, W421824, W451824, W481824, W481824CS	18 1/4" to 20 3/4"	
W242124, W272124, W302124, W332124, W342124, W362124, W372124, W392124, W422124, W452124, W482124, W482124CS	21 1/4" to 23 3/4"	
W242424, W272424, W302424, W332424, W342424, W362424, W372424, W392424, W422424, W452424, W482424, W482424CS	24 1/4" to 26 3/4"	
W361824PO L or R, W361824PO, W371824PO L or R, W371824PO, W391824PO L or R, W391824PO	18 1/4" to 20 3/4"	
W362124PO L or R, W362124PO, W372124PO L or R, W372124PO, W392124PO L or R, W392124PO	21 1/4" to 23 3/4"	
WB12 L or R, WB15 L or R, WB18 L or R, WB21 L or R, WB24 L or R, WB27, WB30, WB33, WB36, WB39, WB42, WB45, WB48	46 1/2"	30"
WC_24 L or R	24 1/4" to 26 3/4"	
WC_27 L or R	27 1/4" to 29 3/4"	
WC_30 L or R	30 1/4" to 32 3/4"	12" to 29 3/4"
WC_33 L or R	33 1/4" to 35 3/4"	
WC_36 L or R	36 1/4" to 38 3/4"	
WC_39 L or R	39 1/4" to 41 3/4"	
WC_42 L or R	42 1/4" to 48"	
WEC1230D, WEC1230 L or R	30 1/4" to 32 3/4"	12" to 29 3/4"
WEC1233D, WEC1233 L or R	33 1/4" to 35 3/4"	
WEC1236D, WEC1236 L or R	36 1/4" to 38 3/4"	
WEC1239D, WEC1239 L or R	39 1/4" to 41 3/4"	
WEC1242D, WEC1242 L or R	42 1/4" to 48"	
WEC1245D, WEC1245 L or R	45 1/4" to 47 3/4"	
WEC1248D, WEC1248 L or R	48 1/4" to 54"	
WOB52436, WOB53036, WOB53636	36 1/4" to 48"	
WTC1230LL	30 1/4" to 32 3/4"	12" to 29 3/4"
WTC1233LL	33 1/4" to 35 3/4"	
WTC1236LL	36 1/4" to 38 3/4"	
WTC1239LL	39 1/4" to 41 3/4"	
WTC1242LL	42 1/4" to 44 3/4"	
WTC1245LL	45 1/4" to 47 3/4"	
WTC1248LL	48 1/4" to 54"	
WTH_30BF	30 1/4" to 32 3/4"	
WTH_33BF	33 1/4" to 35 3/4"	
WTH_15VL	15 1/4" to 17 3/4"	
WTH_18VL	18 1/4" to 20 3/4"	
WTH2412SL, WTH2712SL, WTH3012SL, WTH3312SL, WTH3612SL		9 1/4" to 11 3/4"
WTH2415SL, WTH2715SL, WTH3015SL, WTH3315SL, WTH3615SL	15 1/4" to 17 3/4"	12 1/4" to 14 3/4"
WTH2418SL, WTH2718SL, WTH3018SL, WTH3318SL, WTH3618SL	18 1/4" to 20 3/4"	
WTH2421SL, WTH2721SL, WTH3021SL, WTH3321SL, WTH3621SL	21 1/4" to 23 3/4"	

Custom Modifications

General Cabinet Modifications (cont'd)

	Wall	Base	Tall	Filler	Panel	
Increased	0	0	0	0	0	per cabinet

Increased Widths in 1/4" Increments

Specify IW _____. (Increased Widths in 1/4" Increments)

Modification is restricted to starting with the smaller standard cabinet width and then increasing the width.

For example, to achieve a Wall Cabinet 13 1/4" wide by 12" high, order a W1212 L or R IW13.25.

Many cabinets are available with the Increased Widths 1/4" Increments modification. See chart below for included cabinets and width availabilities.

- Not available in conjunction with some modifications including: Split Doors and Split Drawers.
- When IW is used in conjunction with Clipped Corners or Wide Stiles, then not available with 24" wide Peninsulas, B4D_, B4D_RT, B39RT, B42RT, or B45RT models.
- The following configurations will apply to cabinets with doors and/or drawers:
 - 9" - 23 3/4" - 1 door
 - 24 1/4" - 38 3/4" - 2 door, 1 drawer
 - 39 1/4" - 47 3/4" - 2 door, 2 drawer (will have a mullion between the doors and drawers)

*will not have mullion

NOTE: Changes to cabinets not listed below will be subject to an upcharge.

Increased Width 1/4" Increments				
Cabinet	Description	Page #	Cabinet Widths	
			Minimum	Maximum
Wall Cabinets				
STW	Stacked Wall	J•28	12"	48"
STWAG	Stacked Wall w/Vertical-lift	J•36	15"	36"
STWDAG	Stacked Wall w/Appliance Garage	J•24	15"	36"
W	Wall	J•3	9"	48"
W_P	Wall Peninsula	J•74	9"	48"
W ____ 24 (24"-36" wide)	Wall Refrigerator (24"-36" wide)	J•46	24"	39"
W ____ 24 (42"-45" wide)	Wall Refrigerator (42"-45" wide)	J•46	42"	48"
W ____ 24PO	Refrigerator Wall Pull-out Cabinet	J•49	36"	39"
W ____ 24PO L or R	Refrigerator Wall Pull-out Cabinet	J•49	36"	39"
WTH_BF	Wall Top Hinge w/Bifold	J•15	24"	36"
WTH_SL	Wall Top Hinge w/Stay Lift	J•9	24"	36"
WVL	Wall Top Hinge w/Vertical-lift & Stay Lift	J•5	24"	36"
Base Cabinets				
2DB	Two Drawer Base	L•32	24"	38 3/4"
2DB_RT	Two Drawer Base w/Roll Trays	L•33	18"	36"
3DB*	Three Drawer Base	L•27	12"	42"
3DBBDD_	Three Drawer Base Buffet w/Deep Drawer	L•31	30 1/4"	35 3/4"
3DBDD_	Three Drawer Base w/Deep Drawer	L•29	24 1/4"	35 3/4"
4DB*	Four Drawer Base	L•24	12"	42"
B	Base	L•3	9"	48"
B_FH	Full Height Base	L•12	6"	48"
B_FHP	Full Height Base Peninsula	L•81	9"	48"
B_P	Base Peninsula	L•80	9"	48"
B_RT	Base w/Roll Tray	L•6	12"	48"
B2D	Base w/Two Split Drawers	L•16	9"	36"
B2D_RT	Base w/Two Split Drawers & Roll Tray	L•17	12"	36"
B4D	Base Double Door w/Four Split Drawers	L•18	24"	48"
B4D_RT	Base Double Door w/Four Split Drawers & Roll Tray	L•18	24"	48"
CNTYSB	Country Sink Base Cabinet	L•48	30"	48"
SB	Sink Base	L•38	18"	48"
TD_FH	Full Height Base w/Tray Divider	L•83	6"	18"
WB	Wall Base	L•23	12"	48"
Furniture Drawers				
FDWB	Furniture Drawer Window Bench	L•105	15"	48"
Tall Cabinets				
U	Utility	M•3	12"	36"
U_RT	Utility w/Roll Trays	M•21	15"	36"
U3D	Utility w/Three Drawers	M•16	12"	36"
U4D	Utility w/Four Drawers	M•18	12"	36"
Oven & Microwave Cabinets				
3DB_WD	Three Drawer Base, Warming Drawer	N•11	24"	36"
BBMWD_	Base Built-in Microwave Cabinet w/Drawer	N•13	24 1/4"	32 3/4"
BO	Base Oven Cabinet	N•15	27"	36"
BO_	Base Oven Trimmable Cabinet	N•14	27 1/4"	35 3/4"
BO_LD	Base Oven Cabinet w/Lower Drawer	N•16	27"	36"
BMW_RT	Base Microwave Cabinet w/Roll Tray	N•12	24"	36"
BMWD	Base Microwave Cabinet w/Drawer	N•13	24"	36"
BMWD_DD	Base Microwave Cabinet w/Deep Drawer	N•14	24 1/4"	32 3/4"

General Cabinet Modifications (cont'd)

Increased Width 1/4" Increments				
Cabinet	Description	Page #	Cabinet Widths	
			Minimum	Maximum
Oven & Microwave Cabinets, (cont'd)				
MW	Wall Microwave Double Door Cabinet	N#4	24"	36"
MW_18	Wall Microwave Cabinet, 18" High	N#3	27 1/4"	32 3/4"
MW_21	Wall Microwave Cabinet, 21" High	N#3	27 1/4"	32 3/4"
OCD	Double Oven Trimmable Cabinet	N#35	27"	39"
OCD_DD	Double Oven Trimmable Cabinet w/Deep Drawer	N#51	27 1/4"	35 3/4"
OCD_DDAH	Double Oven Trimmable Cabinet w/Deep Drawer	N#52	27 1/4"	35 3/4"
OCM	Tall Built-in Microwave Cabinet	N#17	27"	39"
OCS	Single Oven Trimmable Cabinet	N#43	27"	39"
OCS_DD	Single Oven Trimmable Cabinet w/Deep Drawer	N#45	27 1/4"	35 3/4"
OCS_DDAH	Single Oven Trimmable Cabinet w/Deep Drawer	N#45	27 1/4"	35 3/4"
OCS_D	Single Oven Trimmable Cabinet w/Drawers	N#37	27"	39"
OMC	Microwave & Single Oven Trimmable Cabinet	N#27	27"	39"
OMC_DD	Microwave & Single Oven Trimmable Cabinet w/Deep Drawer	N#29	27 1/4"	35 3/4"
OMC_DDAH	Microwave & Single Oven Trimmable Cabinet w/Deep Drawer	N#30	27 1/4"	35 3/4"
WBMW	Wall Built-in Microwave Double Door Cabinet	N#9	27 1/4"	32 3/4"
Office & Furniture Cabinets				
DDR	Desk Drawer Base	O#24	12 1/4"	35 3/4"
T_BCAV	Tall Bookcase w/Arched Valance	O#29	18"	36"
TD_BCAV	Tall Bookcase w/Doors & Arched Valance	O#32	18"	36"
TDO_BCAV	Tall Bookcase w/Office Height Doors & Arched Valance	O#38	18"	36"
TDV_BCAV	Tall Bookcase w/Vanity Height Doors & Arched Valance	O#35	18"	36"
W_BCAV	Wall Bookcase w/Arched Valance	O#26	15"	39"
Vanity Cabinets				
4VDB	Vanity Four Drawer Base	P#44	12"	36"
BCST	Bath Storage Tower	P#61	12"	30"
BCSTDRW	Base Storage Tower Single Drawer	P#62	12"	30"
UV	Vanity Utility	P#47	15"	24"
V_S	Vanity Base w/Shelf	P#9	12"	48"
VB	Vanity Base	P#7	12"	48"
VDB	Vanity Three Drawer Base	P#42	12"	36"
VSB	Vanity Sink Base w/False Panel	P#14	18"	48"
Desk Drawers				
UCD	Under Counter Drawer 5" High, 21" Deep	P#46	15 1/4"	35 3/4"
Panels				
TEP_WD	Refrigerator Panel 12" or 13" Deep	Q#16	1 1/2"	6"
TEP_WD	Refrigerator Panel 24" Deep	Q#17	1 1/2"	6"
_3_BCFP	Box Column Filler 3" Wide	Q#10	3 1/4"	5 3/4"
_6_BCFP	Box Column Filler 6" Wide	Q#10	6 1/4"	12"
BEP	Base End Panel 24" Deep, 34 1/2" High	Q#14	1 1/2"	6"
BEPOF3WD	End Panels – Full Overlay Styles Only	Q#15	3"	5 3/4"
WEPOF3_WD	End Panels – Full Overlay Styles Only	Q#15	3"	5 3/4"
TEP_OF3WD	End Panels – Full Overlay Styles Only	Q#15	3"	5 3/4"
WEPF3_WD	Wall End Panel 12" or 13" Deep, 30" High	Q#13	1.5"	6"
Kits & Hardware				
CIW	Cutlery Divider	S#5	12"	36"
CUD	Cooking Utensil Divider	S#4	5"	36"
DRT_SP	Deep Roll Tray Kit	S#9	12"	36"
RT_SP	Roll Tray Kit	S#9	12"	36"
SRT_SP	Scooped Roll Tray Kit	S#10	12"	38 3/4"
Mouldings & Embellishments				
AV	Arch Valance	R#18	84"	96"
VV	Straight Valance	R#19	84"	96"
V_B	Style B Valance	R#19	84"	96"
V_D	Style D Valance	R#19	84"	96"
V_E	Style E Valance	R#19	84"	96"
V_H	Style H Valance	R#20	84"	96"
V_J	Style J Valance	R#20	84"	96"
V_K	Style K Valance	R#20	84"	96"
V_L	Style L Valance	R#20	84"	96"

Custom Modifications

General Cabinet Modifications (cont'd)

	Wall	Base	Tall	Filler	Panel	
Increased	0	0	0	N/A	N/A	per cabinet

Increased Widths in 3" increments

Specify IW __ (Increased Width)

Some cabinets are available with the Increased Width option. See chart below for cabinets with this option along with available sizes.

- To achieve desired widths, select the existing cabinet from below and specify IW along with the new width. For example, to achieve a B036, order a B033 IW36.
- For Wall Quarter Round End Shelf (WQRES), Increased Widths available in 9" and 12". See page J•98 for WQRES cabinets.
- Increased widths available in 3" increments from 15" to 45".

NOTE: Changes to cabinets not listed below will be subject to an upcharge.

Increased Width in 3" Increments												
Cabinet	Description	Page #	Cabinet Widths									
			15"	18"	21"	24"	27"	30"	33"	36"	39"	42"
Wall Cabinets												
WOB53636	Wall Organizer & Bookshelf 36" W	J•92									✓	
Range Hoods												
HP-12	Hearth Pier 12" W	K•22	✓									
Base Cabinets												
2DB36DR	Two Drawer Base, Drop-in Range 36" W	L•55									✓	
2DB36RDR	Two Drawer Base w/Reduced Drawers, Drop-in Range 36" W	L•56									✓	
B36DR	Base, Drop-in Range 36" W	L•56									✓	
BQRES L or R	Base Quarter Round End Shelf	L•101	✓									
Office & Furniture Cabinets												
CPU152924	CPU Base	O•25		✓								
EB12NTK L or R	Entertainment Base w/No ToeKick	O•12	✓	✓								
EB18 L or R	Entertainment Base	O•12			✓	✓						
ESTW1858.5 L or R	Entertainment Stacked Wall	O•13			✓	✓						
EW1236 L or R	Entertainment Wall	O•13	✓	✓								

General Cabinet Modifications (cont'd)

Wall	Base	Tall	Filler	Panel
0	0	0	0	N/A per cabinet

Reduced Widths in 3" increments

Reduced

Specify RW__ (Reduced Width)

Some cabinets are available with the special width option. See chart below for cabinets with this option along with sizes available.

- To achieve desired widths, select the existing cabinet from below and specify RW along with the new width. For example, to achieve a B36DR, order a B36DR RW33.
- Reduced widths available in 3" increments from 9" to 33".

*For Wall Quarter Round End Shelf (WQRES) Reduced Widths available in 5". See page J-98 for WQRES cabinets.

NOTE: Changes to cabinets not listed below will be subject to an upcharge.

Reduced Width in 3" Increments																
Cabinet	Description	Page #	Cabinet Widths													
			9"	12"	15"	18"	21"	24"	27"	30"	33"	36"	39"	42"		
Wall Cabinets																
W618	Wine Cube Horizontal 18" W	J-96		✓												
WCD3015	Wall China Display 30" W	J-95								✓						
WCD3615	Wall China Display 36" W	J-95										✓				
WOB53036	Wall Organizer & Bookshelf 30" W	J-92								✓						
WOB53636	Wall Organizer & Bookshelf 36" W	J-92										✓				
WSD18	Wall Spice Drawer Horizontal 18" W	J-97		✓												
Range Hoods																
HP-12	Hearth Pier 12" W	K-22	✓													
Base Cabinets																
2DB18RT	Two Drawer Base w/Roll Trays 18" W	L-33		✓	✓											
2DB24RT	Two Drawer Base w/Roll Trays 24" W	L-33						✓								
2DB36DR	Two Drawer Base, Drop-in Range 36" W	L-55											✓			
2DB36RDR	Two Drawer Base w/Reduced Drawers, Drop-in Range 36" W	L-56											✓			
B36DR	Base, Drop-in Range 36" W	L-56											✓			
B36RRTDR	Base w/Roll Trays, Drop-in Range 36" W	L-57											✓			
B36RTDR	Base w/Reduced Depth Roll Trays, Drop-in Range 36" W	L-57											✓			
BQRES L or R	Base Quarter Round End Shelf	L-101	✓													
Office & Furniture Cabinets																
4EDB48NTK	Four Drawer Entertainment Base, No Toekick 48" W	0-14							✓		✓		✓			✓
4EDB48	Four Drawer Entertainment Base 48" W	0-13							✓		✓		✓			✓
DF3D182924	Desk File Drawer Base	0-24			✓											
EB18 L or R	Entertainment Base	0-12	✓	✓	✓											
EEDB	Entry Ensemble Drawer Base	0-3		✓	✓											
EEOB	Entry Ensemble Open Base	0-4		✓	✓											
EOD24	Entertainment Open Drawer	0-12	✓	✓	✓	✓	✓									
EESTW	Entry Ensemble Stacked Wall	0-6		✓	✓											
ESTW1858.5 L or R	Entertainment Stacked Wall	0-13	✓	✓	✓											
EESTWO	Entry Ensemble Stacked Wall Open	0-5		✓	✓					✓	✓	✓				
EET	Entry Ensemble Tall	0-3		✓	✓											
EW1236 L or R	Entertainment Wall	0-13	✓													
T18-BCAV	Tall Bookcase w/Arched Valance	0-29			✓											
TD18-BCAV	Tall Bookcase w/Doors & Arched Valance	0-32			✓											
TD018-BCAV	Tall Bookcase w/Office Height Doors & Arched Valance	0-38			✓											
TDV18-BCAV	Tall Bookcase w/Vanity Height Doors & Arched Valance	0-35			✓											

Custom Modifications

General Cabinet Modifications (cont'd)

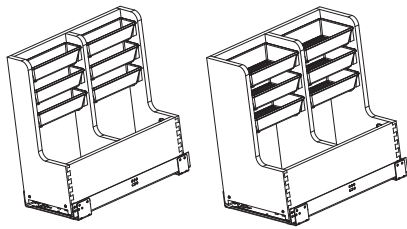

L-shaped Organizer

Specify VLSOL (L-shaped Organizer Left), VLSOR (L-shaped Organizer Right), and VLSOB (L-shaped Organizer Both)

This option installs an L-shaped Organizer.

- L or R designates installed side.
- Includes 6 acrylic bins in upper section.
- Bottom mounted full extension, Smart Stop slides.
- Pull-out dimensions for 12" wide model are 8 3/4" W x 18 3/4" D x 18 13/16" H.
- Pull-out dimensions for 15" wide model are 11 5/8" W x 18 3/4" D x 18 13/16" H.
- Only available as a modification in select 2VSD, VSB, VCSD, VCDB and 6VSD SKUs.

	Wall	Base	Tall	Filler	Panel	
VLSOB	N/A	700	N/A	N/A	N/A	per cabinet
	N/A	1400	N/A	N/A	N/A	per cabinet

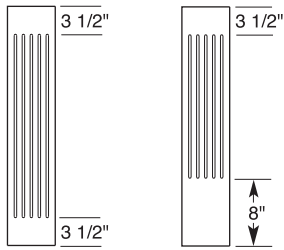

Wall/Base

Base with Flush Toe Kick Option

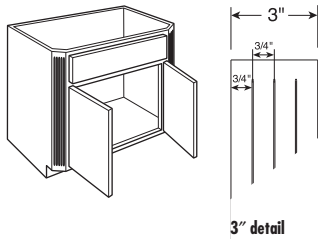

3" detail

Rose Fluting

3"

Wall	Base	Tall	Filler	Panel	
50	50	50	N/A	N/A	per part

Specify ROSFLUT3L (3" Rose Flute Left), ROSFLUT3R (3" Rose Flute Right), ROSFLUT3B (3" Rose Flute Both), ROSFLUT3L.P (3" Rose Flute Left - Peninsula), ROSFLUT3R.P (3" Rose Flute Right - Peninsula), or ROSFLUT3B.P (3" Rose Flute Both - Peninsula)

When Rosettes are selected to be used with Fluting, Rosette Fluting (ROSFLUT) must be specified. This option reduces Fluting length 1" on the top and bottom to provide enough space to attach the Rosettes.

- Any option that extends the stiles (Bottom Valance Rail, Flush Toe Kick, Open Bottom Rail Base, Top Valance Rail, and Wide Top Rail) do not extend the Flute dimensions.
- Special spacing between flutes not available.
- See individual cabinets for availability.

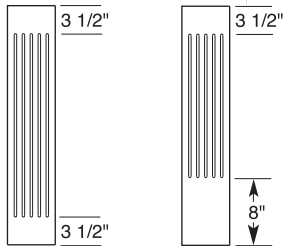

Wall/Base

Base with Flush Toe Kick Option

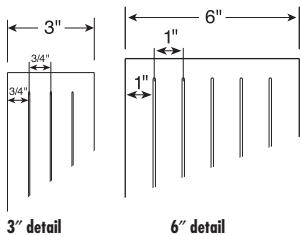

3" detail

6" detail

Rose Fluting on Fillers

3"

N/A	N/A	N/A	50	50	per part
6"	N/A	N/A	95	95	per part

Specify ROSFLUT3 (3" Rose Fluting on Filler) or ROSFLUT3CTR (6" Filler Rose Fluted 3" on Center)

When Rosettes are selected to be used with Fluting, Rosette Fluting (ROSFLUT) must be specified. This option reduces Fluting length 1" on the top and bottom to provide enough space to attach the Rosettes.

- Base and Tall End panels with 3" or 6" frame rail return are available with Fluting. Specify Left or Right.
- Special spacing between flutes is not available.
- Available in 3" or 6".
- The options Wide Bottom Rail, Wide Top Rail and Flush Toe Kick do not extend the flute dimensions.
- See individual fillers and panels for availability.

General Cabinet Modifications (cont'd)

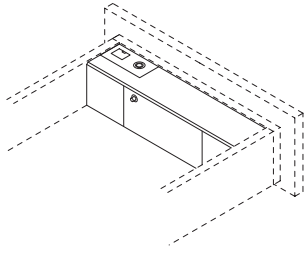

Secured Drawer featuring Master Lock Biometric Technology

DRWSECB

Wall	Base	Tall	Filler	Panel	
N/A	590	N/A	N/A	N/A	per cabinet
N/A	1180	N/A	N/A	N/A	per cabinet

Specify DRWSEC (Secured Drawer featuring Master Lock Biometric Technology), DRWSECL (Secured Drawer featuring Master Lock Biometric Technology Left), DRWSECR (Secured Drawer featuring Master Lock Biometric Technology Right), or DRWSECB (Secured Drawer featuring Master Lock Biometric Technology Both)

Select base cabinets can be ordered with the standard top drawer (5" high frame opening) replaced with the DRWSEC.

- Designed for 18", 21", or 24" base cabinet drawers.
- Full extension, concealed Smart Stop slides.
- 110 lb. rated.
- Special sizes not available.
- Only available in 24" deep.
- Modifies the standard drawer box with an installed self-locking mechanism featuring proven Master Lock advanced sensor biometric technology.
- When activated, drawer opens 2 3/16" to access fingerprint reader, which stores up to 100 unique fingerprints.
- Homeowner must reset memory after cabinet installation.
- Secured housing protrudes 2 3/4" into the depth of the drawer box interior.
- Features one 9V battery compartment (battery not included).
- Self-locking when in closed position.
- Manual key lock on bottom of drawer for backup method of entry.
- Installer must remove the drawer front to drill and countersink the back of the drawer front for field installation of knobs and pulls.
- Available in top drawer(s) only.
- Not available on Inset or Beaded Inset Styles.

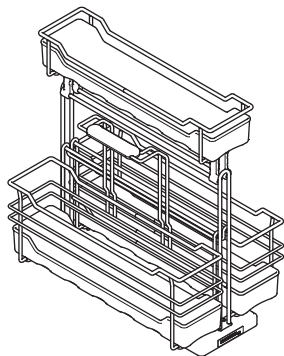

Sink Base Cleaning Caddy

N/A	1225	N/A	N/A	N/A	per cabinet
-----	------	-----	-----	-----	-------------

Specify SBCADDYL (Sink Base Cleaning Caddy Left) or SBCADDYR (Sink Base Cleaning Caddy Right)

- L or R designates installed side.
- Includes one removable basket with handle, one basket without handle, swivel basket and 8 dividers.
- Bottom mounted full extension, Smart Stop slides.
- Caddy dimensions are 11" wide x 20" high x 18 1/2" deep.
- Caddy fits in cabinets with a minimum: 12" wide (15" for inset) x 20 1/2" high (frame opening) x 21" deep.

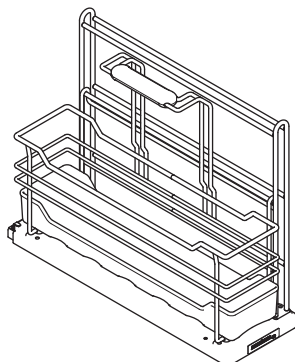

Sink Base Cleaning Caddy Small

N/A	950	N/A	N/A	N/A	per cabinet
-----	-----	-----	-----	-----	-------------

Specify SBCADDYSML (Sink Base Cleaning Caddy Small Left) or SBCADDYSMR (Sink Base Cleaning Caddy Small Right)

- L or R designates installed side.
- Includes one removable basket with handle and four dividers.
- Bottom mounted full extension, Smart Stop slides.
- Caddy dimensions are 6 3/8" wide x 15 3/4" high x 18 1/2" deep.
- Caddy fits in cabinets with a minimum: 9" wide x 16" high (frame opening) x 21" deep.

Custom Modifications

General Cabinet Modifications (cont'd)

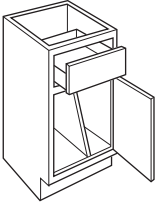

Opening	TD
3	0
6	1
9	1
10 1/2	1
12	2
13 1/2	2
15	2
16 1/2	2
18	3
19 1/2	3
21	3
22 1/2	3
24	4
27	4
30	5
33	5
36	5

Tray Divider

Wall	Base	Tall	Filler	Panel	
140	140	140	N/A	N/A	per divider

Specify **_TD** (Installed Tray Divider), **_TDBTM** (Installed Tray Divider - Bottom), **_TDLBTM** (Installed Tray Divider - Left - Bottom), **_TDRBTM** (Installed Tray Divider - Right - Bottom), **_TDL** (Installed Tray Divider - Left), **_TDMID** (Installed Tray Divider - Middle), **_TDLMID** (Installed Tray Divider - Left - Middle), **_TDRMID** (Installed Tray Divider - Right - Middle), **_TDR** (Installed Tray Divider - Right), **_TDTOP** (Installed Tray Divider - Top), **_TDLTOP** (Installed Tray Divider - Left - Top), or **_TDRTOP** (Installed Tray Divider - Right - Top)

Removable Tray Dividers are available installed in cabinets. The Tray Dividers are Natural regardless of the color of the interior of the cabinet. Opening heights of 9" to 39" can have installed Tray Dividers. Tray Dividers can be installed in cabinets with reduced depths (9" minimum), but may not be installed in units over 30" deep.

- Tray Dividers will be evenly spaced unless specified otherwise. When special spacing is requested, 6" minimum between dividers is required.
- See chart for maximum number of dividers per face frame opening.
- When the Tray Divider (TD) option is chosen, shelf holes will not be drilled in cabinet. Shelves will not ship with cabinet.
- Specify the number of tray dividers between 1 and 5.
- See individual cabinets for availability.

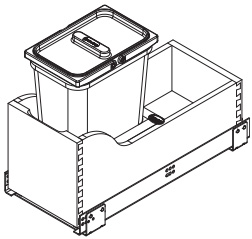

Vanity Wastebasket Container

N/A	1200	N/A	N/A	N/A	per cabinet
-----	------	-----	-----	-----	-------------

Specify **VWBL** (Vanity Wastebasket Container Left) or **VWBR** (Vanity Wastebasket Container Right)

This option installs a Vanity Wastebasket Container.

- L or R designates installed side.
- Includes 8 qt. wastebin.
- Bottom mounted full extension, Smart Stop slides.
- Pull-out dimensions: 8 5/8" W x 18 9/16" D x 13 15/16" H.

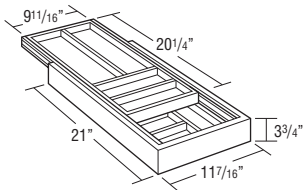

Wood Tiered Cutlery Divider Drawer

N/A	430	430	N/A	N/A	per cabinet
N/A	850	850	N/A	N/A	per cabinet

Specify **WTCD** (Installed Wood Tiered Cutlery Divider Drawer), **WTCDL** (Installed Wood Tiered Cutlery Divider Drawer Left), **WTCDR** (Installed Wood Tiered Cutlery Divider Drawer Right), or **WTCDDB** (Installed Wood Tiered Cutlery Divider Drawer Both)

Many base cabinets can be ordered with the standard top drawer (5" high frame opening) replaced with the WTCD.

- The WTCD is available in six sizes, see chart for availability.
- Available on 24" deep cabinets only.
- Special sizes not available.
- WTCD15 shown. Different sizes of the cutlery dividers may have different configurations. Please reference page S•5 for more details.

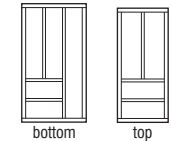

WTCD15

Cabinet Width	Frame Opening Width
15"	12"
18"	15"
21"	18"
24"	21"
30"	27"
36"	33"

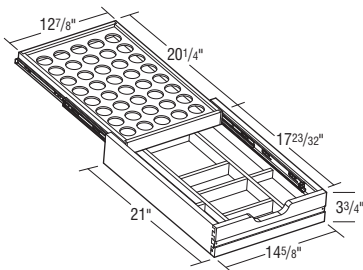

Wood Tiered K-Cup* Drawer

N/A	670	670	N/A	N/A	per cabinet
N/A	1340	1340	N/A	N/A	per cabinet

Specify **WTKCUP** (Installed Wood Tiered K-Cup Drawer), **WTKCUPL** (Installed Wood Tiered K-Cup Drawer Left), **WTKCUPR** (Installed Wood Tiered K-Cup Drawer Right), or **WTKCUPB** (Installed Wood Tiered K-Cup Drawer Both)

Many base cabinets can be ordered with the standard top drawer (5" high frame opening) replaced with the WTKCUP.

- The WTKCUP is available in 15" frame opening width.
- Holds 40 K-Cups.
- The Wood Tiered K-Cup Drawer is compatible with K-Cup pods only.
- Available on 24" deep cabinets only.
- Special sizes not available.

*K-Cup is a registered trademark of Keurig Green Mountain, Inc.

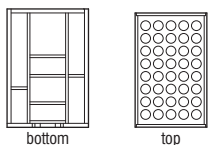

Recommendations for Fully Accessible/Barrier-Free Design

Many Diamond Edge modifications may be utilized to increase cabinet accessibility and convenience for the elderly, the physically challenged, and other individuals with special needs.

For your reference when designing for wheelchair access, the most commonly accepted industry standard for toe-kick space is between 8" and 9" high with a 6" set-back. This may be achieved with Diamond Edge cabinetry by ordering an 8 1/2" high, 6" deep toe space; contact customer service for pricing.

The most commonly accepted height for tables and work surfaces is 30" to 33". Ordering 32 1/2" high Diamond Edge base and vanity base cabinets achieves this standard; call customer service for details.

The addition of roll trays in cabinet interiors is recommended. Utilize the Roll Trays option listed in this "Modifications" section.

The use of easily-gripped cabinet handles and/or knobs is recommended. Choose from several selections in the "Hardware" section of the Diamond Edge Product and Price Catalog.

The following information from the U.S. Government Publication American National Standards and other sources may also be helpful:

Wheelchair dimensions: length – 42"; open width – 25"; collapsed width – 11"; seat to floor – 19 1/2"; armrest to floor – 29".

Wheelchair access: Minimum turn space for 360° turn – 60"; minimum turn space for 180° turn – 36"; side reach limits – 9" to 54"; safest ramp slope – 1:12; table height – 30" to 33".

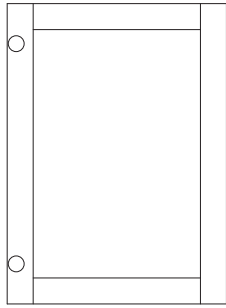

Door Only

With this option, you can order a special size door with or without hinging.

- Full Overlay Styles:
 - Specify width in 1/32" increments from 8 9/16" to 24".
 - Specify height in 1/32" increments from 11 9/16" to 61 1/16".
- Inset & Beaded Inset Styles:
 - Specify width in 1/32" increments from 5 13/16" to 24".
 - Specify height in 1/32" increments from 8 13/16" to 58 5/16".
 - No Hinge Cut modification available, see page 6•16 for details.

Model	Price	
DOORONLY	124	per sq. ft.

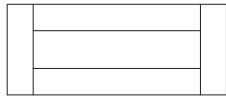

Drawer Front Only

With this option, you can order a special size drawer front.

- Full Overlay Styles:
 - Specify width in 1/32" increments from 7 1/2" to 47 9/16".
 - Specify height in 1/32" increments from 4 1/4" to 14 23/32".
- Inset & Beaded Inset Styles:
 - Specify width in 1/32" increments from 5 13/16" to 47 9/16".
 - Specify height in 1/32" increments from 3 13/32" to 14 23/32".

DRWFRTONLY	124	per sq. ft.
-------------------	------------	-------------

Door Size Chart

Diamond Edge Standard Door Size Chart

NOTE: Using a combination of width and height on this chart must also coincide with standard cabinet size offering. Example: A W912 L or R is not a standard size cabinet offering, therefore an 8 9/16" W x 11 9/16" H door cannot be ordered as a standard door.

Width			
Cabinet Width Where Used	FOL Door Style	Miter Door Style	Inset & Beaded Inset Door Style
BLS33 L or R	7 7/8	7 7/8	7 11/32
9	8 9/16	8 9/16	5 13/16
ER's, BLS36 L or R, etc.	10 7/8	10 7/8	10 11/32
DAB335LS L or R	11 1/4	11 1/4	9 1/16
12	11 9/16	11 9/16	8 13/16
B24	11 3/4	11 3/4	10 11/32
27 Split DR	13 1/16	13 1/16	10 5/16
27 Butt DR	13 1/4	13 1/4	11 27/32
15, 30 Split DR	14 9/16	14 9/16	11 13/16
30 Butt DR	14 3/4	14 3/4	13 11/32
Diagonal	15	15	11 7/8
33 Split DR	16 1/16	16 1/16	13 5/16
33 Butt DR	16 1/4	16 1/4	14 27/32
18, 36 Split DR	17 9/16	17 9/16	14 13/16
36 Butt DR	17 3/4	17 3/4	16 11/32
ACS39 L or R	18 1/4	18 1/4	16 5/16
39 Split DR	19 1/16	19 1/16	16 5/16
39 Butt DR	19 1/4	19 1/4	17 27/32
21, 42	20 9/16	20 9/16	17 13/16
45	22 1/16	22 1/16	19 5/16
24, 48	23 9/16	23 9/16	20 13/16

Height			
Cabinet Height Where Used	FOL Door Style	Miter Door Style	Inset & Beaded Inset Door Style
W_12	11 9/16	11 9/16	8 13/16
W_15	14 9/16	14 9/16	11 13/16
W_18	17 9/16	17 9/16	14 13/16
W_21	20 9/16	20 9/16	17 13/16
W_24	23 9/16	23 9/16	20 13/16
W_27	26 9/16	26 9/16	23 13/16
W_30	29 9/16	29 9/16	26 13/16
W_33	32 9/16	32 9/16	29 13/16
W_36	35 9/16	35 9/16	32 13/16
W_39	38 9/16	38 9/16	35 13/16
W_42	41 9/16	41 9/16	38 13/16
W_45	44 9/16	44 9/16	41 13/16
W_48	47 9/16	47 9/16	44 13/16
STWDAG, DW_DOB - BOTTOM DOOR	17 9/16	17 9/16	16 5/16
STWAG, DW_AG - BOTTOM DOOR	17 13/16	17 13/16	N/A
HP1254 L or R, HPP1254 L or R - BOTTOM DOOR	28 5/16	28 5/16	25 9/16
H36DF_23.5	20 9/16	20 9/16	17 13/16
H54DF_12.75	11 9/16	11 9/16	8 13/16
H60DF_17.5	14 9/16	14 9/16	11 13/16
B	22 13/16	22 13/16	20 5/16
B2D, B4D	16 3/32	16 3/32	13 13/16
B_FH	29 17/32	29 17/32	26 13/16
BCC	16 3/32	16 3/32	13 13/16
CNTYSB	19 1/16	19 1/16	16 5/16
B_DR, B_RTDR, B_RRTDR	22 9/16	22 9/16	20 5/16
HB	16 3/32	16 3/32	13 13/16
U3D, U4D 84" tall	49 1/16	49 1/16	46 5/16
U3D, U4D 87" tall	52 1/16	52 1/16	49 5/16
U3D, U4D 90" tall	55 1/16	55 1/16	52 5/16
U3D, U4D 93" tall	58 1/16	58 1/16	55 5/16
U3D, U4D 96" tall	61 1/16	61 1/16	58 5/16
U - BOTTOM DOOR	61 1/16	61 1/16	58 5/16
UI - MIDDLE DOOR	24 25/32	24 25/32	22 5/16
TPP - BOTTOM DOOR	61 1/16	61 1/16	N/A
VB (32"H)	20 5/16	20 5/16	17 13/16
VB (34.5"H)	22 13/16	22 13/16	20 5/16
V_S (32"H)	27 1/32	27 1/32	24 5/16
V_S (34.5"H)	29 17/32	29 17/32	26 13/16
LC - UPPER DOOR	49 11/32	49 11/32	N/A
BCBCD	21 5/16	21 5/16	18 13/16
BCBH_D	29 17/32	29 17/32	26 13/16
BCWHDBPO_D	23 17/32	23 17/32	20 13/16
BCSTDRW_49.5	34 5/16	34 5/16	32 1/16
BCSTDRW_55.5	40 5/16	40 5/16	38 1/16
BCSTDRW_61.5	46 5/16	46 5/16	44 1/16
BCSTDRW_67.5	52 5/16	52 5/16	50 1/16
BCSTDRW_73.5	58 5/16	58 5/16	56 1/16
BCSTDRW_79.5	49 9/16	49 9/16	47 5/16
BCSTDRW_85.5	55 9/16	55 9/16	53 5/16
BCSTDRW_91.5	61 9/16	61 9/16	59 5/16

Refer to pages F•8-F•13 Standard Opening Sizes for standard opening heights of cabinets listed in the Width chart above.

Doors ordered as Authentic will have an unfinished back.
Doors in 1/32" increments will need to be ordered through the parts list.

Replacement doors available at \$124 per square foot.

Diamond Edge Standard Drawer Front Size Chart

NOTE: Using a combination of width and height on this chart must also coincide with standard cabinet size offering. Example: A 4DB09 is not a standard size cabinet offering, therefore an 8 9/16" W x 6 1/2" H drawer front cannot be ordered as a standard drawer front.

Width			
Cabinet Width Where Used	FOL Door Style	Miter Door Style	Inset & Beaded Inset Door Style
9	8 9/16	8 9/16	5 13/16
12	11 9/16	11 9/16	8 13/16
24	23 9/16	23 9/16	20 13/16
27	26 9/16	26 9/16	23 13/16
27 Split DRW	13 1/16	13 1/16	10 5/16
30	29 9/16	29 9/16	26 13/16
15, 30 Split DRW	14 9/16	14 9/16	11 13/16
33	32 9/16	32 9/16	29 13/16
33 Split DRW	16 1/16	16 1/16	13 5/16
18, 36 Split DRW	17 9/16	17 9/16	14 13/16
36	35 9/16	35 9/16	32 13/16
39	38 9/16	38 9/16	35 13/16
39 Split DRW	19 1/16	19 1/16	16 5/16
21, 42 Split DRW	20 9/16	20 9/16	17 13/16
45 Split DRW	22 1/16	22 1/16	19 5/16
48 Split DRW	23 9/16	23 9/16	20 13/16

Height			
Cabinet Height Where Used	FOL Door Style	Miter Door Style	Inset & Beaded Inset Door Style
ADRW	5 3/4	5 3/4	4 1/16
A2DRW	5 3/4	5 3/4	4 1/16
A2DRW18 - 1st	5 3/4	5 3/4	4 1/16
A2DRW18 - 2nd	11 3/4	11 3/4	10 1/16
A3DRW	5 3/4	5 3/4	4 1/16
Base	6 1/2	6 1/2	4 13/16
B2D & B4D - 1st	6 1/2	6 1/2	4 13/16
B2D & B4D - 2nd	6 1/2	6 1/2	4 13/16
2DB_RT - 1st	14 21/32	14 21/32	12 9/16
2DB_RT - 2nd	14 21/32	14 21/32	12 9/16
2DB_28 - 1st	10 23/32	10 23/32	8 13/16
2DB_28 - 2nd	12 19/32	12 19/32	10 5/16
2DB_DR - 1st	11 9/32	11 9/32	9 5/16
2DB_DR - 2nd	11 9/32	11 9/32	9 5/16
4 Drawer Base - 1st (32"H)	6 1/2	6 1/2	4 13/16
4 Drawer Base - 2nd (32"H)	6 1/2	6 1/2	4 13/16
4 Drawer Base - 3rd (32"H)	6 1/2	6 1/2	4 13/16
4 Drawer Base - 4th (32"H)	6 7/8	6 7/8	4 13/16
4 Drawer Base - 1st (34.5"H)	6 1/2	6 1/2	4 13/16
4 Drawer Base - 2nd (34.5"H)	6 1/2	6 1/2	4 13/16
4 Drawer Base - 3rd (34.5"H)	6 1/2	6 1/2	4 13/16
4 Drawer Base - 4th (34.5"H)	9 3/8	9 3/8	7 5/16

Height			
Cabinet Height Where Used	FOL Door Style	Miter Door Style	Inset & Beaded Inset Door Style
3 Drawer Base - 1st (32"H)	6 1/2	6 1/2	4 13/16
3 Drawer Base - 2nd (32"H)	7 1/2	7 1/2	4 13/16
3 Drawer Base - 3rd (32"H)	12 19/32	12 19/32	10 5/16
3 Drawer Base - 1st (34.5"H)	6 1/2	6 1/2	4 13/16
3 Drawer Base - 2nd (34.5"H)	11 9/32	11 9/32	9 5/16
3 Drawer Base - 3rd (34.5"H)	11 9/32	11 9/32	9 5/16
File Drawer Base - 1st (30")	5 3/4	5 3/4	4 1/16
File Drawer Base - 2nd (30")	5 3/4	5 3/4	4 1/16
File Drawer Base - 3rd (30")	13 3/32	13 3/32	11 5/16
File Drawer Base - 1st (34.5")	6 1/2	6 1/2	4 13/16
File Drawer Base - 2nd (34.5")	9 1/2	9 1/2	7 13/16
File Drawer Base - 3rd (34.5")	13 3/32	13 3/32	11 5/16
BCC - large front	13 7/32	13 7/32	11 5/16
UCD	4 3/4	4 3/4	3 13/32
BCWHC	11 17/32	11 17/32	8 13/16
BCBCO	8	8	6 5/16
BCBCD	8	8	6 5/16
BCBH_D - 1st	9 11/16	9 11/16	N/A
BCBH_D - 2nd	9 11/16	9 11/16	N/A
BCBH_D - 3rd	9 11/16	9 11/16	N/A
BCWHDB - 1st	11 21/32	11 21/32	9 9/16
BCWHDB - 2nd	11 21/32	11 21/32	9 9/16
BCDB - 1st	6 1/2	6 1/2	4 13/16
BCDB - 2nd	8 1/16	8 1/16	6 9/16
BCDB - 3rd	14 17/32	14 17/32	12 1/16
BC2DB - 1st	14 21/32	14 21/32	12 9/16
BC2DB - 2nd	14 21/32	14 21/32	12 9/16
BCDRW	14 25/32	14 25/32	12 1/16
BCSTDRW_49.5, 55.5, 61.5, 67.5, 73.5	14 17/32	14 17/32	12 9/16
BCSTDRW_79.5, 85.5, 91.5 - 1st	14 17/32	14 17/32	12 13/16
BCSTDRW_79.5, 85.5, 91.5 - 2nd	14 17/32	14 17/32	12 13/16
EET	12 25/32	12 25/32	10 5/16
EEDB	12 25/32	12 25/32	10 5/16
EOD	10 13/16	10 13/16	8 5/16
4EDB - 1st	10 29/32	10 29/32	8 13/16
4EDB - 2nd	10 29/32	10 29/32	8 13/16
4EDB_NTK - 1st	6 1/2	6 1/2	4 13/16
4EDB_NTK - 2nd	10 13/16	10 13/16	8 5/16
6EDB - 1st	10 29/32	10 29/32	8 13/16
6EDB - 2nd	10 29/32	10 29/32	8 13/16
EBDB - 1st	6 1/2	6 1/2	4 13/16
EBDB - 2nd	10 13/16	10 13/16	8 5/16
DF3D - 1st	5 3/4	5 3/4	4 1/16
DF3D - 2nd	5 3/4	5 3/4	4 1/16
DF3D - 3rd	12 27/32	12 27/32	11 5/16

Refer to pages F08-F13 for standard opening heights of cabinets listed in the Width chart above.

Drawer Fronts ordered as Authentic will have an unfinished back.

Replacement drawer fronts available at \$124 per square foot.

Specialty Doors

Gallery Mullion Doors Pricing and Ordering Procedures

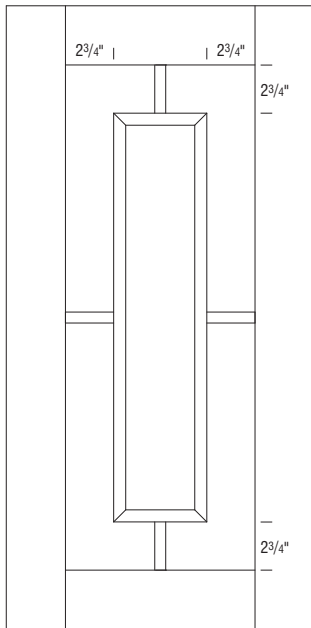

- When ordering glass mullion doors, use Diamond Edge's standard cabinet item number (W3030, W2430 L or R, DW302424 L or R, etc.) and then designate the corresponding option name (see below) in the description portion of the purchase order.
- All glass mullion doors ordered will be of the same wood species, finish, door style, hinge selection, and profile as the other cabinets specified on the original kitchen order unless instructed otherwise.
- Do not make any deductions for the standard wood doors included in the list prices of wall cabinets.
- Add price from chart for the number of mullion doors on cabinet to standard list price of cabinet.
- Base full with mullion doors — use 30" cabinet height price.
- Base with mullion doors — use 24" cabinet height price.
- Door is prepared for glass insert; dealer must supply glass. Designed to utilize one piece of glass per door — not separate panes. Clips for inserting glass included in installation package. Doors are pre-drilled for clips.
- Door styles not available include: Brooks, Brooks Beaded Inset, Brooks Inset, Daxton, Daxton Beaded Inset, Daxton Inset, Wells, Langley, Langley Beaded Inset, Langley Inset, Trystan, Trystan Beaded Inset, Trystan Inset, Tackett, Tackett Beaded Inset, and Tackett Inset.
- Must specify Matching Interior if desired. When a decorative door option is chosen in 20/20, Matching Interior Plywood (MIP) is a preselected option. If MIP is not desired, it can be deselected by choosing NOTMIP.
- Mullion doors are not available on cabinets that are taller than 48".
 - This includes any cabinet that is modified to be taller than 48".

Muntin Profiles

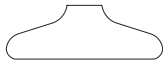

Caldera



- Gunther
- Gunther Beaded Inset
- Gunther Inset
- Karis
- Karis Beaded Inset
- Karis Inset



- Sumner
- Montgomery
- Montgomery Beaded Inset
- Montgomery Inset

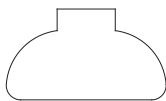

- Shona
- Shona Beaded Inset
- Shona Inset



- Vesta
- Vesta Beaded Inset
- Vesta Inset

Option Name	Cabinet Height	Price per Door
GAMD15	15"	305
GAMD18	18"	317
GAMD21	21"	331
GAMD24	24"	342
GAMD27	27"	356
GAMD30	30"	368
GAMD33	33"	383
GAMD36	36"	397
GAMD39	39"	413
GAMD42	42"	431
GAMD45	45"	449
GAMD48	48"	467

Door Style	Min. Door Width	Min. Door Height	Min. Cabinet Width	Min. Cabinet Height
Caldera	16 1/4"	17 9/16"	18"	18"
Gunther	13 1/4"	14 9/16"	15"	15"
Gunther Beaded Inset	14 13/16"	14 13/16"	18"	18"
Gunther Inset	14 13/16"	14 13/16"	18"	18"
Karis	13 1/4"	14 9/16"	15"	15"
Karis Beaded Inset	14 13/16"	14 13/16"	18"	18"
Karis Inset	14 13/16"	14 13/16"	18"	18"
Montgomery	13 1/4"	14 9/16"	15"	15"
Montgomery Beaded Inset	14 13/16"	14 13/16"	18"	18"
Montgomery Inset	14 13/16"	14 13/16"	18"	18"
Shona	13 1/4"	14 9/16"	15"	15"
Shona Beaded Inset	14 13/16"	14 13/16"	18"	18"
Shona Inset	14 13/16"	14 13/16"	18"	18"
Sumner	16 1/4"	17 9/16"	18"	18"
Vesta	13 1/4"	14 9/16"	15"	15"
Vesta Beaded Inset	14 13/16"	14 13/16"	18"	18"
Vesta Inset	14 13/16"	14 13/16"	18"	18"

Mullion Doors Pricing and Ordering Procedures

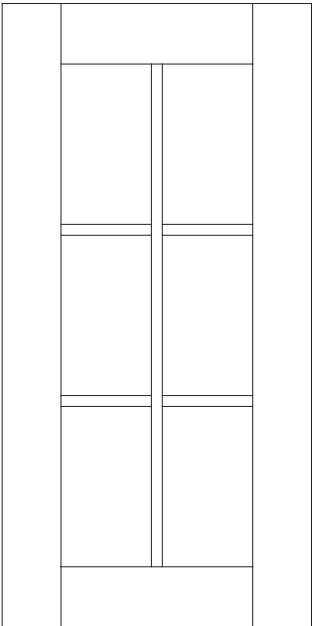

- When ordering glass mullion doors, use Diamond Edge’s standard cabinet item number (W3030, W2430 L or R, DW302424 L or R, etc.) and then designate the corresponding option name (see below) in the description portion of the purchase order.
- All glass mullion doors ordered will be of the same wood species, finish, door style, hinge selection, and profile as the other cabinets specified on the original kitchen order unless instructed otherwise.
- Do not make any deductions for the standard wood doors included in the list prices of wall cabinets.
- Add price from chart for the number of mullion doors on cabinet to standard list price of cabinet.
- Base full with mullion doors—use 30” cabinet height price.
- Base with mullion doors—use 24” cabinet height price.
- Door is prepared for glass insert; dealer must supply glass. Designed to utilize one piece of glass per door— not separate panes. Clips for inserting glass included in installation package. Doors are pre-drilled for clips.
- Door styles not available include: Brooks, Brooks Beaded Inset, Brooks Inset, Daxton, Daxton Beaded Inset, Daxton Inset, Wells, Langley, Langley Beaded Inset, Langley Inset, Trystan, Trystan Beaded Inset, Trystan Inset, Tackett, Tackett Beaded Inset, Tackett Inset, Vesta Beaded Inset, and Vesta Inset.
- Full Overlay:
 - Not available on cabinets with bifold doors, cabinets less than 15” high or more than 48” high and cabinets less than 12” wide.
- Inset and Beaded Inset:
 - Not available on cabinets with bifold doors, cabinets less than 18” high or more than 48” high and cabinets less than 15” wide.
- Must specify Matching Interior if desired. When a decorative door option is chosen in 20/20, Matching Interior Plywood (MIP) is a preselected option. If MIP is not desired, it can be deselected by choosing NOTMIP.

Muntin Profiles

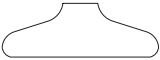

Caldera



Gunther
 Gunther Beaded Inset
 Gunther Inset
 Karis
 Karis Beaded Inset
 Karis Inset



Sumner
 Montgomery
 Montgomery Beaded Inset
 Montgomery Inset

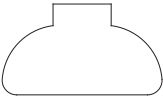

Shona
 Shona Beaded Inset
 Shona Inset



Vesta

Option Name	Cabinet Height	Number of Lites per Door	Price per Door
MD15	15”	4	162
MD18	18”	4	172
MD21	21”	4	182
MD24	24”	4	194
MD27	27”	4	205
MD30	30”	6	217
MD33	33”	6	231
MD36	36”	6	245
MD39	39”	8	260
MD42	42”	8	273
MD45	45”	8	292
MD48	48”	8	308

Specialty Doors

Prairie Mullion Doors Pricing and Ordering Procedures

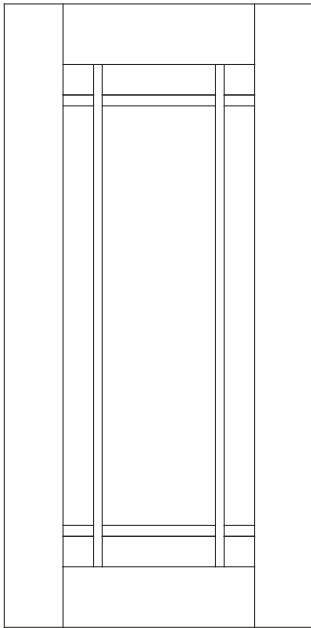

- When ordering Prairie glass mullion doors, use Diamond Edge’s standard cabinet item number (W3030, W2430 L or R, DW302424 L or R, etc.) and then designate the corresponding option name (see below) in the description portion of the purchase order.
- All glass mullion doors ordered will be of the same wood species, finish, door style, hinge selection, and profile as the other cabinets specified on the original kitchen order unless instructed otherwise.
- Do not make any deductions for the standard wood doors included in the list prices of wall cabinets.
- Add price from chart for the number of mullion doors on cabinet to standard list price of cabinet.
- Base full with mullion doors — use 30” cabinet height price.
- Base with mullion doors — use 24” cabinet height price.
- Door is prepared for glass insert; dealer must supply glass. Designed to utilize one piece of glass per door — not separate panes. Clips for inserting glass included in installation package. Doors are pre-drilled for clips.
- Doors more than 48” tall have two panels routed for glass, divided by a horizontal mullion.
- Door styles not available include: Brooks, Brooks Beaded Inset, Brooks Inset, Daxton, Daxton Beaded Inset, Daxton Inset, Wells, Langley, Langley Beaded Inset, Langley Inset, Trystan, Trystan Beaded Inset, Trystan Inset, Tackett, Tackett Beaded Inset, Tackett Inset, Vesta Beaded Inset, and Vesta Inset.
- Full Overlay and 3/4” Overlay:
 - Not available on cabinets with bifold doors, cabinet less than 18” high or more than 48” high, cabinets less than 12” wide, and 24” wide two door cabinets.
- Inset and Beaded Inset:
 - Not available on cabinets with bifold doors, cabinets less than 21” high or more than 48” high and cabinets less than 15” wide.
- Must specify Matching Interior if desired. When a decorative door option is chosen in 20/20, Matching Interior Plywood (MIP) is a preselected option. If MIP is not desired, it can be deselected by choosing NOTMIP.

Muntin Profiles

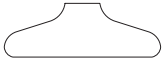

Caldera



Gunther
 Gunther Beaded Inset
 Gunther Inset
 Karis
 Karis Beaded Inset
 Karis Inset



Sumner
 Montgomery
 Montgomery Beaded Inset
 Montgomery Inset

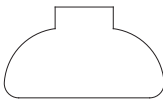

Shona
 Shona Beaded Inset
 Shona Inset



Vesta

Option Name	Cabinet Height	Price per Door
PRMD18	18”	188
PRMD21	21”	199
PRMD24	24”	210
PRMD27	27”	224
PRMD30	30”	237
PRMD33	33”	251
PRMD36	36”	266
PRMD39	39”	283
PRMD42	42”	299
PRMD45	45”	317
PRMD48	48”	337

Shaker Mullion Doors Pricing and Ordering Procedures

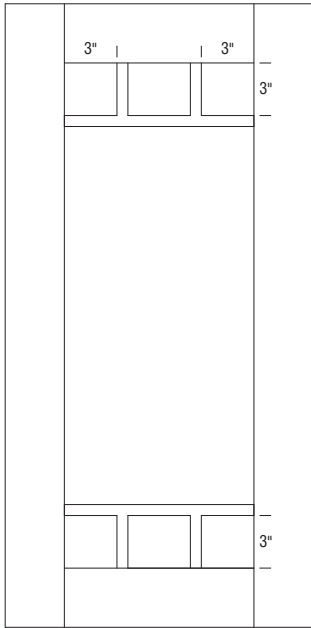

- When ordering glass mullion doors, use Diamond Edge’s standard cabinet item number (W3030, W2430 L or R, DW302424 L or R, etc.) and then designate the corresponding option name (see below) in the description portion of the purchase order.
- All glass mullion doors ordered will be of the same wood species, finish, door style, hinge selection, and profile as the other cabinets specified on the original kitchen order unless instructed otherwise.
- Do not make any deductions for the standard wood doors included in the list prices of wall cabinets.
- Add price from chart for the number of mullion doors on cabinet to standard list price of cabinet.
- Base full with mullion doors—use 30” cabinet height price.
- Base with mullion doors—use 24” cabinet height price.
- Door is prepared for glass insert; dealer must supply glass. Designed to utilize one piece of glass per door—not separate panes. Clips for inserting glass included in installation package. Doors are pre-drilled for clips.
- Door styles not available include: Brooks, Brooks Beaded Inset, Brooks Inset, Daxton, Daxton Beaded Inset, Daxton Inset, Wells, Langley, Langley Beaded Inset, Langley Inset, Trystan, Trystan Beaded Inset, Trystan Inset, Tackett, Tackett Beaded Inset, and Tackett Inset.
- Must specify Matching Interior if desired. When a decorative door option is chosen in 20/20, Matching Interior Plywood (MIP) is a preselected option. If MIP is not desired, it can be deselected by choosing NOTMIP.
- Mullion doors are not available on cabinets that are taller than 48”.
 - This includes any cabinet that is modified to be taller than 48”.

Option Name	Cabinet Height	Price per Door
SHMD15	15”	305
SHMD18	18”	317
SHMD21	21”	331
SHMD24	24”	342
SHMD27	27”	356
SHMD30	30”	368
SHMD33	33”	383
SHMD36	36”	397
SHMD39	39”	413
SHMD42	42”	431
SHMD45	45”	449
SHMD48	48”	467

Muntin Profiles

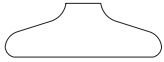

Caldera



- Gunther
- Gunther Beaded Inset
- Gunther Inset
- Karis
- Karis Beaded Inset
- Karis Inset



- Sumner
- Montgomery
- Montgomery Beaded Inset
- Montgomery Inset

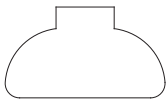

- Shona
- Shona Beaded Inset
- Shona Inset



- Vesta
- Vesta Beaded Inset
- Vesta Inset

Door Style	Min. Door Width	Min. Door Height	Min. Cabinet Width	Min. Cabinet Height	Door Size Range for Single Vertical Muntin	Door Size Range for Double Vertical Muntin
Caldera	13 1/4”	17 9/16”	15”	18”	14 9/16” to 16 15/16”	17” to 23 9/16”
Gunther	11 9/16”	17 9/16”	12”	18”	11 9/16” to 14 1/2”	14 9/16” to 23 9/16”
Gunther Beaded Inset	11 13/16”	17 13/16”	15”	21”	11 13/16” to 14 1/2”	14 9/16” to 23 9/16”
Gunther Inset	11 13/16”	17 13/16”	15”	21”	11 13/16” to 14 1/2”	14 9/16” to 23 9/16”
Karis	11 9/16”	17 9/16”	12”	18”	11 9/16” to 14 1/2”	14 9/16” to 23 9/16”
Karis Beaded Inset	11 13/16”	17 13/16”	15”	21”	11 13/16” to 14 1/2”	14 9/16” to 23 9/16”
Karis Inset	11 13/16”	17 13/16”	15”	21”	11 13/16” to 14 1/2”	14 9/16” to 23 9/16”
Montgomery	11 9/16”	17 9/16”	12”	18”	11 9/16” to 14 1/2”	14 9/16” to 23 9/16”
Montgomery Beaded Inset	11 13/16”	17 13/16”	15”	21”	11 13/16” to 14 1/2”	14 9/16” to 23 9/16”
Montgomery Inset	11 13/16”	17 13/16”	15”	21”	11 13/16” to 14 1/2”	14 9/16” to 23 9/16”
Shona	11 9/16”	17 9/16”	12”	18”	11 9/16” to 14 1/2”	14 9/16” to 23 9/16”
Shona Beaded Inset	11 13/16”	17 13/16”	15”	21”	11 13/16” to 14 1/2”	14 9/16” to 23 9/16”
Shona Inset	11 13/16”	17 13/16”	15”	21”	11 13/16” to 14 1/2”	14 9/16” to 23 9/16”
Sumner	13 1/4”	17 9/16”	15”	18”	14 9/16” to 16 15/16”	17” to 23 9/16”
Vesta	11 9/16”	17 9/16”	12”	18”	11 9/16” to 14 1/2”	14 9/16” to 23 9/16”
Vesta Beaded Inset	11 13/16”	17 13/16”	15”	21”	11 13/16” to 14 1/2”	14 9/16” to 23 9/16”
Vesta Inset	11 13/16”	17 13/16”	15”	21”	11 13/16” to 14 1/2”	14 9/16” to 23 9/16”

Specialty Doors

Craftsman Doors Pricing and Ordering Procedures

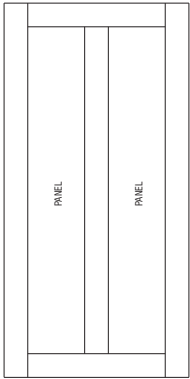

CCP (Craftsman with Center Panels)

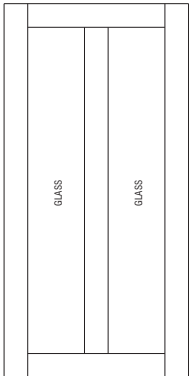

CCG (Craftsman with Cut-for-glass)

- When ordering Craftsman Door, use Diamond Edge's standard cabinet item number (W2430 L or R, W4830, etc.) and then designate the corresponding option name (see below) in the description portion of the purchase order.
- All Craftsman Doors ordered will be of the same wood species, finish, door style, hinge selection, and profile as the other cabinets specified on the original kitchen order unless instructed otherwise.
- Craftsman Doors available on wall cabinets only starting at 12" height through 48" height cabinets.
- Both sections will be equal size.
- Due to the width and height size limitations for Craftsman Doors, the Authentic Flush End modification may not match the Craftsman Door configuration specified. The door configuration for Authentic Flush End modification will be the CCP option when achievable (Cut-for-glass is not available), otherwise the door configuration will match the door style of the order. Refer to page H•9 for minimum width and height by style.
- Due to the width and height size limitations for Craftsman Doors, the Face Frame and Door on End modification may not match the Craftsman Door configuration specified. The door configuration for Face Frame and Door on End modification will match the Craftsman option chosen when achievable, otherwise the door configuration will match the door style of the order. Refer to page H•9 for minimum width and height by style.
- If Craftsman option is selected in conjunction with IPEL or IPER option, the IPE doors will NOT match the front doors on the cabinet. They will remain standard doors on the IPE side. The door widths are too small to produce in Craftsman Door type.
- If Craftsman option is selected in conjunction with INTGEL or INTGER option, the INTEGRAL doors will NOT match the front doors on the cabinet. They will remain standard doors on the integral side. The door widths are too small to produce in Craftsman Door type.
- Door styles not available include: Trystan, Trystan Inset, Tackett, and Tackett Inset.
- Matching Interior must be specified on CCG if desired. When a decorative door option is chosen in 20/20 for CCG, Matching Interior Plywood (MIP) is a preselected option. If MIP is not desired, it can be deselected by choosing NOTMIP.
- See chart on page H•9 for minimum width and height availability by style.

	Wall	Base	Tall	Filler	Panel	
CCP/CCP.TOP/CCP.BTM/CCP.P	200	N/A	N/A	N/A	N/A	per door
CCG/CCG.TOP/CCG.BTM/CCG.P	200	N/A	N/A	N/A	N/A	per door

- For CCG modification, the door is prepared for glass. Two separate, equal sizes of glass will be required. Clips for inserting glass included in cabinet.
- Glass is not included.
- Art Glass is not available.
- See chart below for minimum width and height per door style for glass availability through Diamond Edge.

Craftsman Door Minimums for Diamond Edge to Supply Glass		
Door Style	Min. Door Width	Min. Door Height
Brooks	16 1/4"	11 9/16"
Caldera	18 1/2"	11 9/16"
Daxton	18 1/4"	11 9/16"
Daxton Inset	18 1/4"	11 9/16"
Gunther	16 1/4"	11 9/16"
Gunther Inset	16 1/4"	11 9/16"
Karis	16 1/4"	11 9/16"
Karis Inset	16 1/4"	11 9/16"
Langley	16 1/4"	11 9/16"
Langley Inset	16 1/4"	11 9/16"
Montgomery	16 1/4"	11 9/16"
Montgomery Inset	16 1/4"	11 9/16"
Shona	16 1/4"	11 9/16"
Shona Inset	16 1/4"	11 9/16"
Sumner	18 1/2"	11 9/16"
Tackett	N/A	N/A
Tackett Inset	N/A	N/A
Trystan	N/A	N/A
Trystan Inset	N/A	N/A
Vesta	16 1/4"	11 9/16"
Wells	18 1/4"	11 9/16"

Craftsman Doors Pricing and Ordering Procedures (cont'd)

Door Style	Min. Door Width	Min. Door Height	Min. Cabinet Width	Min. Cabinet Height
Brooks	11 9/16"	11 9/16"	12"	12"
Caldera	18 1/2"	11 9/16"	14 3/4"	12"
Daxton	14 1/4"	11 9/16"	14 3/4"	12"
Daxton Inset	14 1/4"	11 9/16"	17 1/2"	14 3/4"
Gunther	11 9/16"	11 9/16"	12"	12"
Gunther Inset	11 9/16"	11 9/16"	14 3/4"	14 3/4"
Karis	11 9/16"	11 9/16"	12"	12"
Karis Inset	11 9/16"	11 9/16"	14 3/4"	14 3/4"
Langley	13 1/2"	11 9/16"	14"	12"
Langley Inset	13 1/2"	11 9/16"	16 3/4"	14 3/4"
Montgomery	16 1/4"	11 9/16"	12"	12"
Montgomery Inset	11 9/16"	11 9/16"	14 3/4"	14 3/4"
Shona	11 3/4"	11 9/16"	12 1/4"	12"
Shona Inset	11 13/16"	11 9/16"	15"	14 3/4"
Sumner	18 1/2"	11 9/16"	14 3/4"	12"
Tackett	N/A	N/A	N/A	N/A
Tackett Inset	N/A	N/A	N/A	N/A
Trystan	N/A	N/A	N/A	N/A
Trystan Inset	N/A	N/A	N/A	N/A
Vesta	11 9/16"	11 9/16"	12"	12"
Wells	18 1/4"	11 9/16"	14 3/4"	12"

Specialty Doors

Horizon Doors Pricing and Ordering Procedures

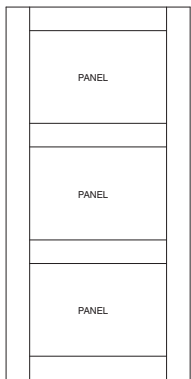

HCP (Horizon with Center Panels)

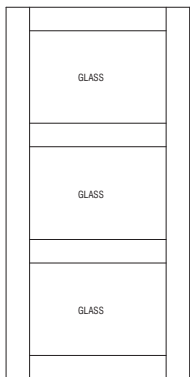

HCG (Horizon with Cut-for-glass)

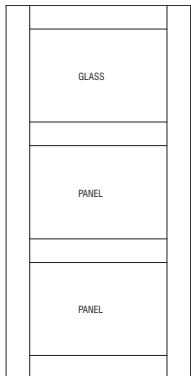

HCGCP (Horizon with Cut-for-glass Top and Center Panels)

- When ordering Horizon Door, use Diamond Edge's standard cabinet item number (W2430 L or R, W4830, etc.) and then designate the corresponding option name (see below) in the description portion of the purchase order.
- All Horizon Doors ordered will be of the same wood species, finish, door style, hinge selection, and profile as the other cabinets specified on the original kitchen order unless instructed otherwise.
- Horizon Doors available on wall cabinets only starting at 30" height through 48" height cabinets.
- For HCG modification, the door is prepared for glass. Three separate, equal sizes of glass will be required. Clips for inserting glass included in cabinet.
- For HCGCP modification, the top section only is prepared for glass. Clips for inserting glass included in cabinet.
- All three sections will be equal size.
- Due to the width and height size limitations for Horizon Doors, the Authentic Flush End modification may not match the Horizon Door configuration specified. The door configuration for Authentic Flush End modification will be the HCP option when achievable (Cut-for-glass is not available), otherwise the door configuration will match the door style of the order. Refer to page H•10 for minimum width and height by style.
- Due to the width and height size limitations for Horizon Doors, the Face Frame and Door on End modification may not match the Horizon Door configuration specified. The door configuration for Face Frame and Door on End modification will match the Horizon option chosen when achievable, otherwise the door configuration will match the door style of the order. Refer to page H•10 for minimum width and height by style.
- If Horizon option is selected in conjunction with IPEL or IPER option, the IPE doors will NOT match the front doors on the cabinet. They will remain standard doors on the IPE side. The door widths are too small to produce in Horizon Door type.
- If Horizon option is selected in conjunction with INTGEL or INTGER option, the INTEGRAL doors will NOT match the front doors on the cabinet. They will remain standard doors on the integral side. The door widths are too small to produce in Horizon Door type.
- When Modified Full Overlay modification is selected in conjunction with Horizon, the three sections will remain equal.
- Door styles not available include: Trystan and Trystan Inset.
- Matching Interior must be specified on HCG and HCGCP if desired. When a decorative door option is chosen in 20/20 for HCG and HCGCP, Matching Interior Plywood (MIP) is a preselected option. If MIP is not desired, it can be deselected by choosing NOTMIP.
- See chart on page H•10 for minimum width and height availability by style.

	Wall	Base	Tall	Filler	Panel	
HCP/HCP.TOP/HCP.BTM/HCP.P	200	N/A	N/A	N/A	N/A	per door
HCG/HCG.TOP/HCG.BTM/HCG.P	200	N/A	N/A	N/A	N/A	per door
HCGCP/HCGCP.TOP/HCGCP.BTM/HCGCP.P	200	N/A	N/A	N/A	N/A	per door

Door Style	Min. Door Width	Min. Door Height	Min. Cabinet Width	Min. Cabinet Height
Brooks	11 9/16"	29 9/16"	12"	30"
Caldera	11 9/16"	29 9/16"	12"	30"
Daxton	11 9/16"	29 9/16"	12"	30"
Daxton Inset	11 13/16"	26 13/16"	15"	30"
Gunther	11 9/16"	29 9/16"	12"	30"
Gunther Inset	11 13/16"	26 13/16"	15"	30"
Karis	11 9/16"	29 9/16"	12"	30"
Karis Inset	11 13/16"	26 13/16"	15"	30"
Langley	11 9/16"	29 9/16"	12"	30"
Langley Inset	11 13/16"	26 13/16"	15"	30"
Montgomery	11 9/16"	29 9/16"	12"	30"
Montgomery Inset	11 13/16"	26 13/16"	15"	30"
Shona	11 9/16"	29 9/16"	12"	30"
Shona Inset	11 13/16"	26 13/16"	15"	30"
Sumner	11 9/16"	29 9/16"	12"	30"
Tackett	11 9/16"	29 9/16"	12"	30"
Tackett Inset	11 13/16"	26 13/16"	15"	30"
Trystan	N/A	N/A	N/A	N/A
Trystan Inset	N/A	N/A	N/A	N/A
Vesta	11 9/16"	29 9/16"	12"	30"
Wells	11 9/16"	29 9/16"	12"	30"

Mission Doors Pricing and Ordering Procedures

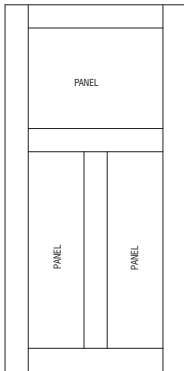

MCP (Mission with Center Panels)

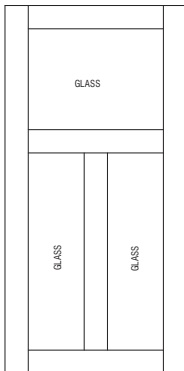

MCG (Mission with Cut-for-glass)

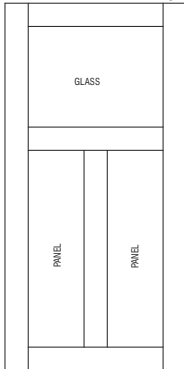

MCGCP (Mission with Cut-for-glass Top and Center Panels)

- When ordering Mission Door, use Diamond Edge's standard cabinet item number (W2430 L or R, W4830, etc.) and then designate the corresponding option name (see below) in the description portion of the purchase order.
- All Mission Doors ordered will be of the same wood species, finish, door style, hinge selection, and profile as the other cabinets specified on the original kitchen order unless instructed otherwise.
- Mission Doors available on wall cabinets only starting at 30" height through 48" height cabinets.
- For MCG modification, the door is prepared for glass. Three separate pieces of glass in two sizes will be required. Clips for inserting glass included in cabinet.
- For MCGCP modification, the top section only is prepared for glass. Clips for inserting glass included in cabinet.
- The upper section of the door will always have a 12" tall section, which includes the width of the upper crossrails and the upper opening.
- Bottom section is two equal sections.
- Due to the width and height size limitations for Mission Doors, the Authentic Flush End modification may not match the Mission Door configuration specified. The door configuration for Authentic Flush End modification will be the MCP option when achievable (Cut-for-glass is not available), otherwise the door configuration will match the door style of the order. Refer to page H•12 for minimum width and height by style.
- Due to the width and height size limitations for Mission Doors, the Face Frame and Door on End modification may not match the Mission Door configuration specified. The door configuration for Face Frame and Door on End modification will match the Mission option chosen when achievable, otherwise the door configuration will match the door style of the order. Refer to page H•12 for minimum width and height by style.
- If Mission option is selected in conjunction with IPEL or IPER option, the IPE doors will NOT match the front doors on the cabinet. They will remain standard doors on the IPE side. The door widths are too small to produce in Mission Door type.
- If Mission option is selected in conjunction with INTGEL or INTGER option, the INTEGRAL doors will NOT match the front doors on the cabinet. They will remain standard doors on the integral side. The door widths are too small to produce in Mission Door type.
- Door styles not available include: Trystan, Trystan Inset, Tackett, and Tackett Inset.
- Matching Interior must be specified on MCG and MCGCP if desired. When a decorative door option is chosen in 20/20 for MCG and MCGCP, Matching Interior Plywood (MIP) is a preselected option. If MIP is not desired, it can be deselected by choosing NOTMIP.
- See chart on page H•12 for minimum width and height availability by style.

	Wall	Base	Tall	Filler	Panel	
MCP/MCP.TOP/MCP.BTM/MCP.P	200	N/A	N/A	N/A	N/A	per door
MCG/MCG.TOP/MCG.BTM/MCG.P	200	N/A	N/A	N/A	N/A	per door
MCGCP/MCGCP.TOP/MCGCP.BTM/MCGCP.P	200	N/A	N/A	N/A	N/A	per door

- For MCG modification, the door is prepared for glass; dealer must supply glass. Each opening will require a separate piece of glass. Clips for inserting glass included in installation package.
- Glass is not included. When ordering glass, three separate pieces of glass in two sizes will be required. Art Glass is not available.
- See chart below for minimum width and height per door style for glass availability through Diamond Edge.

Mission Door Minimums for Diamond Edge to Supply Glass		
Door Style	Min. Door Width	Min. Door Height
Brooks	16 1/4"	29 9/16"
Caldera	18 1/2"	29 9/16"
Daxton	18 1/4"	29 9/16"
Daxton Inset	18 1/4"	26 13/16"
Gunther	16 1/4"	29 9/16"
Gunther Inset	16 1/4"	26 13/16"
Karis	16 1/4"	29 9/16"
Karis Inset	16 1/4"	26 13/16"
Langley	16 1/4"	29 9/16"
Langley Inset	16 1/4"	26 13/16"
Montgomery	16 1/4"	29 9/16"
Montgomery Inset	16 1/4"	26 13/16"
Shona	16 1/4"	29 9/16"
Shona Inset	16 1/4"	26 13/16"
Sumner	18 1/2"	29 9/16"
Tackett	N/A	N/A
Tackett Inset	N/A	N/A
Trystan	N/A	N/A
Trystan Inset	N/A	N/A
Vesta	16 1/4"	29 9/16"
Wells	18 1/4"	29 9/16"

Specialty Doors

Mission Doors Pricing and Ordering Procedures (cont'd)

Door Style	Min. Door Width	Min. Door Height	Min. Cabinet Width	Min. Cabinet Height
Brooks	11 9/16"	29 9/16"	12"	30"
Caldera	18 1/2"	29 9/16"	14 3/4"	30"
Daxton	14 1/4"	29 9/16"	14 3/4"	30"
Daxton Inset	14 1/4"	26 13/16"	17 1/2"	30"
Gunther	11 9/16"	29 9/16"	12"	30"
Gunther Inset	11 9/16"	26 13/16"	14 3/4"	30"
Karis	11 9/16"	29 9/16"	12"	30"
Karis Inset	11 9/16"	26 13/16"	14 3/4"	30"
Langley	13 1/2"	29 9/16"	14"	30"
Langley Inset	13 1/2"	29 13/16"	16 3/4"	30"
Montgomery	16 1/4"	29 9/16"	12"	30"
Montgomery Inset	11 9/16"	26 13/16"	14 3/4"	30"
Shona	11 3/4"	29 9/16"	12 1/4"	30"
Shona Inset	11 13/16"	26 13/16"	15"	30"
Sumner	18 1/2"	29 9/16"	14 3/4"	30"
Tackett	N/A	N/A	N/A	N/A
Tackett Inset	N/A	N/A	N/A	N/A
Trystan	N/A	N/A	N/A	N/A
Trystan Inset	N/A	N/A	N/A	N/A
Vesta	11 9/16"	29 9/16"	12"	30"
Wells	18 1/4"	29 9/16"	14 3/4"	30"

Transom Doors Pricing and Ordering Procedures

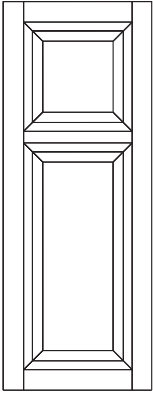

TCP (Transom with both sections Center Panel)

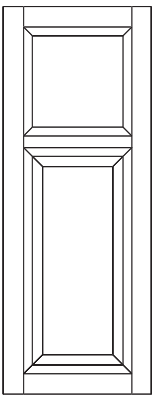

TCG (Transom with Top Cut-for-glass and Bottom Center Panel)

- Cabinets can be ordered with Transom Doors. Clips to attach glass are included.
- The upper section of the door will always have a 12" tall section, which includes the width of the upper crossrails and the upper opening.
- Authentic End will always be Transom with both sections Center Panel.
- Face Frame and Door on End option will always match the face.
- Center panel standard on lower section. Cut-for-glass Door option available on lower section.
- When Modified Full Overlay modification is selected in conjunction with Transom, the bottom section of door will decrease in height by 1 inch.
- Glass is not included.
- Available on:
 - Daxton, Caldera, Gunther, Sumner, Wells, Karis, Montgomery, and Tackett.
 - 36", 39", 42", 45" and 48" high doors
- Transom with Top for Glass and Bottom Center Panel (TCG) not available on:
 - Corner Walls and Wall Message Centers.
- When a decorative door option is chosen in 20/20 for TCG, TCPCG or TCGCG, Matching Interior Plywood (MIP) is a preselected option. If MIP is not desired, it can be deselected by choosing NOTMIP.

Option Name	Cabinet Height	Price per Door
TCG / TCP	36"	140
TCG / TCP	39"	140
TCG / TCP	42"	140
TCG / TCP	45"	140
TCG / TCP	48"	140

Specialty Doors

Aluminum Doors

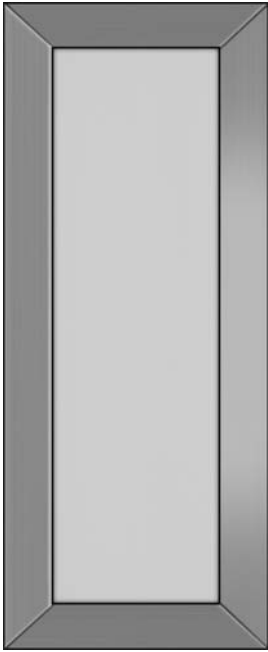

- Available in full overlay and inset styles.
- Inset finial hinges not available on aluminum doors.
- Limited cabinet availability, see chart below for details.
- Must specify Matching Interior if desired. When a decorative door option is chosen in 20/20, Matching Interior Plywood (MIP) is a preselected option. If MIP is not desired, it can be deselected by choosing NOTMIP.
- Specify profile in desired finish and insert. Reference pages H●15-H●17 for profile, finish and insert availability.
- Use of decorative hardware with profile AFO06 and Glass or Backpainted Glass insert must be pre-drilled. Refer to Aluminum Frame Door Order Form, page V●9.

Aluminum Doors Availability
B9FH L or R - B48FH
DW_AGS (top door only)
DW, DW_S (top, bottom, or both)
DW_P
EET, EESTWO, EESTW
HP (excluding the pull-out section)
MW
STW12__-STW48__ (top, bottom or both)
STWAG__ (top door only)
U (upper)
U3D
U4D
UOC (upper)
WOBS
W_P
W___24 (Wall Refrigerator)
W9__-W48__
WB
WC
WEC, AEW, AEWFFD, AEW-45, AEWFFD-45
WWR

Aluminum Door Profiles

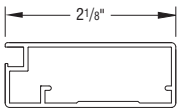

Profile AF003

- Available in the following anodized finishes:
 - Natural Aluminum and Brushed Stainless.
- Available in the following powder coated finishes:
 - Black, White and Oil Rubbed Bronze.
- Specify door to be modified. See order form for details.

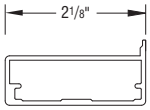

Profile AF006

- Available with backpainted glass insert only.
- Available in the following anodized finishes:
 - Natural Aluminum and Brushed Stainless.
- Available in the following powder coated finishes:
 - Black, White and Oil Rubbed Bronze.
- Specify door to be modified. See order form for details.
- If Decorative hardware drilling is required it must be specified on Glass and Backpainted Glass inserts. Refer to Aluminum Frame Door Order Form, page V●9. Glass inserts are tempered and cannot be drilled after this process.

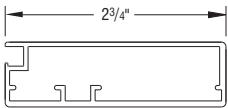

Profile AF007

- Available in the following anodized finishes:
 - Natural Aluminum and Brushed Stainless.
- Available in the following powder coated finishes:
 - Black, White and Oil Rubbed Bronze.
- Specify door to be modified. See order form for details.

Specialty Doors

Aluminum Door Profiles Pricing

Profile and Finish		Cabinet Height													
Profile	Natural Aluminum	12"	15"	18"	21"	24"	27"	30"	33"	36"	39"	42"	45"	48"	51"
AF003	AF003NA	614	627	641	652	666	678	691	704	715	728	742	753	766	779
AF006	AF006NA	647	663	678	695	710	727	743	759	774	791	806	821	838	853
AF007	AF007NA	627	642	656	669	683	698	710	725	739	752	766	779	795	808

Profile and Finish		Cabinet Height													
Profile	Brushed Stainless	12"	15"	18"	21"	24"	27"	30"	33"	36"	39"	42"	45"	48"	51"
AF003	AF003S	643	659	674	690	705	720	737	752	766	782	798	813	829	844
AF006	AF006S	682	701	720	741	759	777	798	817	837	855	875	896	913	934
AF007	AF007S	675	696	714	733	750	770	789	807	827	845	864	883	902	919

Profile and Finish		Cabinet Height													
Profile	Rubbed Bronze	12"	15"	18"	21"	24"	27"	30"	33"	36"	39"	42"	45"	48"	51"
AF003	AF003RB	702	725	745	766	789	809	830	853	873	896	916	939	960	980
AF006	AF006RB	736	760	784	808	834	859	883	907	931	956	980	1006	1030	1054
AF007	AF007RB	715	738	760	784	806	828	851	873	897	918	942	964	987	1010

Profile and Finish			Cabinet Height													
Profile	White	Black	12"	15"	18"	21"	24"	27"	30"	33"	36"	39"	42"	45"	48"	51"
AF003	AF003W	AF003B	702	725	745	766	789	809	830	853	873	896	916	939	960	980
AF006	AF006W	AF006B	736	760	784	808	834	859	883	907	931	956	980	1006	1030	1054
AF007	AF007W	AF007B	715	738	760	784	806	828	851	873	897	918	942	964	987	1010

Inserts for Aluminum Doors

Inserts are required for the preceding aluminum door profiles

Glass	Modification
Clear Glass	AF_CLEAR
Satin Glass	AF_SATIN

Backpainted Glass Finish	Modification
White Gloss	AF_WHITE_GLO
White Matte	AF_WHITE_MAT
Bronze Gloss	AF_BRONZE_GLO
Bronze Matte	AF_BRONZE_MAT

Metallic Inserts	Modification
Aluminum Laminate	AF_ALUMINUM
Brushed Stainless Laminate	AF_STAINLESS
Platinum Ice Acrylic	AF_PLATINUM

Insert Finish	Cabinet Height													
	12"	15"	18"	21"	24"	27"	30"	33"	36"	39"	42"	45"	48"	51"
Clear glass	333	338	343	349	356	360	367	372	376	384	390	395	401	406
Satin glass	358	369	381	394	405	416	429	440	451	464	476	490	501	512
Backpainted glass - gloss	401	423	445	469	492	513	538	560	582	604	627	650	672	696
Backpainted glass - matte	444	477	511	545	578	611	646	679	712	747	780	813	848	880
Metallic Inserts	444	477	511	545	578	611	646	679	712	747	780	813	848	880

Specialty Doors

Decorative Glass Insert Pricing

Art Glass Inserts (Pricing is for glass only)

Style	Panel Thickness	Caming Material	Modification Code	HEIGHT												
				12"	15"	18"	21"	24"	27"	30"	33"	36"	39"	42"	45"	48"
Anson	1/4"	Zinc Black Patina	ANSO__	N/A	448	448	497	497	497	497	547	547	547	547	598	598
Avalon	1/4"	Zinc	AVAL__	N/A	1060	1060	1073	1073	1100	1140	1169	1169	1219	1219	1290	1290
Beckett	1/4"	Zinc Black Patina	BECK__	N/A	1140	1140	1140	1169	1169	1181	1208	1208	1236	1236	1258	1258
Bennington Brass	1/4"	Brass	BENB__	N/A	995	1008	1008	1031	1031	1073	1140	1140	1169	1169	1236	1236
Bennington Patina	1/4"	Zinc Black Patina	BENP__	N/A	1046	1068	1096	1133	1133	1171	1256	1256	1319	1319	1381	1381
Delray	1/4"	Zinc	DELR__	N/A	750	750	750	777	803	834	857	857	872	872	899	899
Emery*	1/4"	Copper	EMER__	N/A	N/A	1181	1208	1208	1208	1249	1272	1272	1313	1313	1380	1380
Foster	1/4"	Zinc	FOST__	N/A	N/A	1524	1535	1560	1582	1607	1642	1642	1678	1678	1738	1738
Merrimack	1/4"	Zinc Black Patina	MERR__	N/A	N/A	1302	1313	1313	1327	1353	1410	1410	1464	1464	1516	1516
Serafina	1/4"	Brass	SERA__	N/A	870	893	893	893	893	940	984	984	1010	1010	1057	1057
Stratton	1/4"	Brass	STRA__	N/A	538	552	578	578	590	590	605	605	605	605	616	616
Waterbury	1/4"	Zinc Black Patina	WATE__	N/A	533	533	590	590	590	590	651	651	651	651	711	711
Westerly	1/4"	Zinc	WEST__	N/A	857	872	872	872	887	887	899	899	926	926	953	953
Wickford	1/4"	Zinc	WICK__	N/A	504	504	561	561	561	561	616	616	616	616	673	673
Winslet	1/4"	Zinc Black Patina	WISL__	N/A	1181	1181	1181	1208	1208	1249	1272	1272	1313	1313	1380	1380
Wright	1/4"	Zinc Black Patina	WRIG__	N/A	1236	1236	1236	1249	1272	1302	1353	1353	1396	1396	1449	1449

*Not available in 9", 12", 27", or W24 wide cabinets.

Art Glass not available on: Base Rotating Deep Bin, Transom Door Cabinets, Corner Wall Cabinets, 9" wide cabinets, Wall Top Hinge with Stay Lift Cabinets, Lazy Susan Base Cabinets, Square Base Corner Cabinets, Super Space Saver Cabinets, Super Lazy Susan Base Cabinets, Diagonal Square Base Corner 33" Cabinets, and Diagonal Super Space Saver 33" Cabinets.

Glass will be shipped directly to the order destination from the glass manufacturing facility within standard lead times.

Cut-for-glass (CG) door must be ordered separately.

Textured Glass Inserts (Pricing is for glass only)

Style	Panel Thickness	Modification Code	HEIGHT												
			12"	15"	18"	21"	24"	27"	30"	33"	36"	39"	42"	45"	48"
Antique [†]	1/8"	ANTQ__	385	385	385	385	385	385	488	586	586	684	684	728	728
Beveled [†]	1/4"	BEVE__	304	304	304	304	304	383	448	511	511	572	572	622	622
Beveled Fog [†]	1/4"	BEVF__	385	385	385	385	385	385	488	586	586	684	684	728	728
Bronze Fabric	3/16"	MBRF__	741	741	741	741	741	741	870	1078	1078	1304	1304	1431	1431
Centurian	1/8"	CENT__	279	279	279	310	310	310	310	340	340	340	340	370	370
Clear [†]	1/8"	CLEA__	213	213	213	262	262	325	325	375	375	460	460	460	460
Diamond Lattice [†]	1/8"	DIAL__	304	304	304	304	304	304	336	383	383	448	448	497	497
Frost [†]	5/32"	FROS__	336	336	336	336	336	336	383	476	476	544	544	622	622
Hammered	5/32"	HAMM__	182	182	182	202	202	202	202	221	221	221	221	241	241
Kinetic [†]	1/4"	KINE__	465	465	465	465	465	465	556	675	675	791	791	883	883
Morisco [†]	1/8"	MORS__	465	465	465	465	465	465	556	675	675	791	791	883	883
Reeded [†]	5/32"	REED__	363	363	363	363	363	363	405	464	464	523	523	605	605
Ridge [†]	1/8"	RIDG__	363	363	363	363	363	363	405	464	464	523	523	605	605
Seeded	9/32"	SEED__	544	544	544	544	544	544	622	766	766	893	893	1037	1037
Silhouette	1/8"	SILH__	279	279	279	310	310	310	310	340	340	340	340	370	370

[†]Not available in W912 L or R, W1212 L or R, W2412 and W2712.

The following glass inserts are not available on 12" wide Transom Door Cabinets: Seeded and Metallic Bronze Fabric.

Textured Glass not available on: Base Rotating Deep Bin, 9" wide cabinets, Corner Wall Cabinets, Lazy Susan Base Cabinets, Square Base Corner Cabinets, Super Space Saver Cabinets, Super Lazy Susan Base Cabinets, Diagonal Square Base Corner 33" Cabinet, and Diagonal Super Space Saver 33" Cabinet.

Glass will be shipped directly to the order destination from the glass manufacturing facility within standard lead times.

Cut-for-glass (CG) door must be ordered separately.

Decorative Art Glass Doors*



Anson

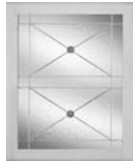

Avalon

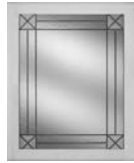

Beckett



Bennington Brass



Bennington Patina



Delray



Emery



Foster



Merrimack

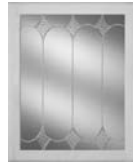

Serafina



Stratton



Waterbury



Westerly

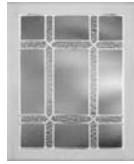

Wickford



Winslet



Wright

*Suggested for use with Square door styles

Decorative Textured Glass Doors



Antique

Clear glass with surface striations simulating the texture and appearance of popular mouthblown antique glass. Uniform thickness, color, texture, highly transparent.



Beveled*

1/4" clear glass with a 1 1/4" bevel. Transparent in appearance.



Beveled Fog

1/4" gray tinted tempered glass with a 1" beveled edge.



Centurian

1/8" frost etched glass. Not recommended for use with Mullion Doors.



Clear

Clear glass.



Diamond Lattice

Laminated clear glass with a diamond wire pattern interlayer. Transparent in appearance.



Frost

Clear glass with one surface "acid etched" to create a frosted appearance. Translucent in appearance.



Hammered

5/32" hammered glass.



Kinetic

5/32" obscure tempered glass with a random, vertical pattern resembling small twigs.



Bronze Fabric

Laminated clear glass with a metallic bronze fabric interlayer. Translucent in appearance.



Morisco

5/32" obscure tempered glass with a unique, raised, repetitive pattern.



Reeded

Clear glass with 1/2" flutes or reeds. Transparent in appearance.



Ridge Glass

5/32" tempered glass with 1/8" vertical reeds—obscure in appearance.



Seeded

Clear textured 9/32" glass with "seeds," small air bubbles trapped in the glass at random. Transparent in appearance.



Silhouette

1/8" frost etched glass. Suggested to use with square doors. Not recommended for use with Mullion Doors. Transparent in appearance.

*Suggested for use with Square door styles. Not suggested for use with Langley.

Specialty Doors

Anson

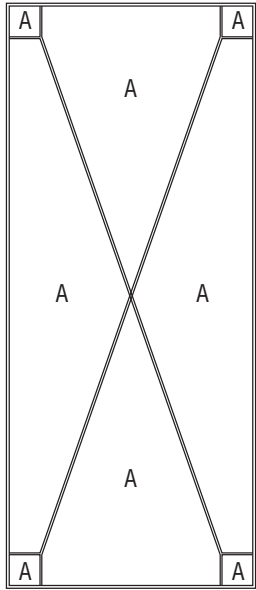

1 3/8
1 3/8

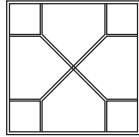

Glass Types:

A) Clear Seedy 100SDY

Metal Types:

3/16" H-Ch Zinc Proglaze2 (all) Black Patina Finish

Minimum Width 6"
Minimum Height 6"

Avalon

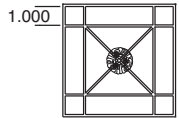
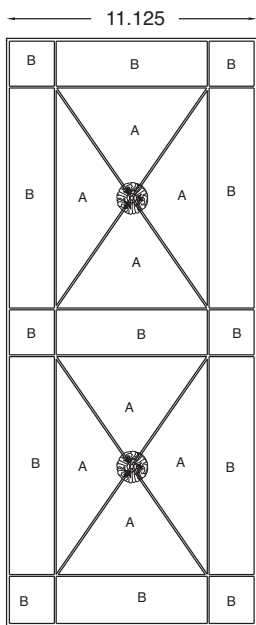

WIDTHS < 8"
1" BORDERS

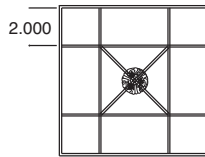

WIDTHS >= 8"
2" BORDERS

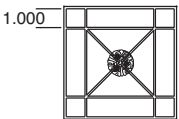

HEIGHTS < 8"
1" BORDERS

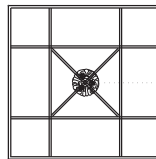

HEIGHTS < 15"
1 INTERSECTION

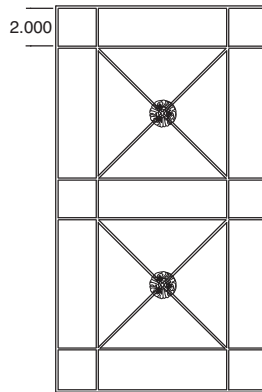

HEIGHTS > 15"
2 INTERSECTIONS



METAL ROSETTE APPLICATION

Glass Types:

A) Clear Waterglass 100W

B) 1/8" Clear

Metal Types:

3/16" H-CH Zinc PROGLAZE2 (All)

Minimum Width 5 1/2"
Minimum Height 5 1/2"

Beckett

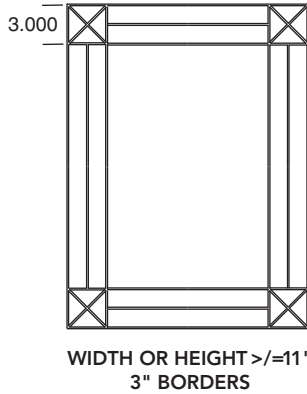
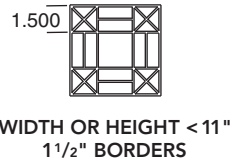
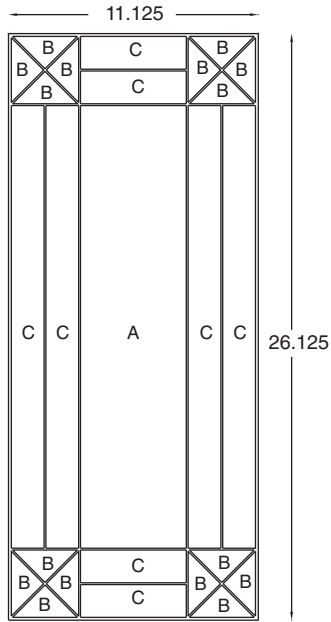

Glass Types:
A) 3/16" Clear
B) Frost ETCH 100
C) Seedy Clear 100SDY

Minimum Width 5 1/2"
Minimum Height 5 1/2"

Metal Types:
3/16" H-CH ZINC PROGLAZE2 (All) Patina

Bennington Brass

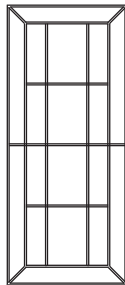
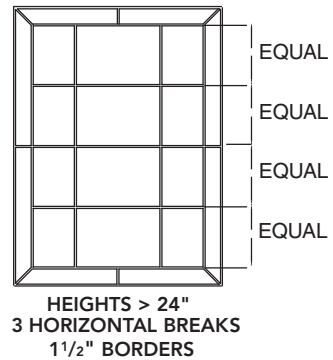
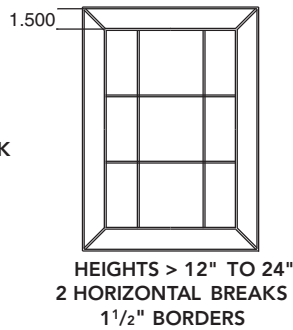
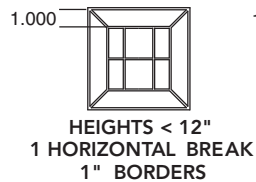
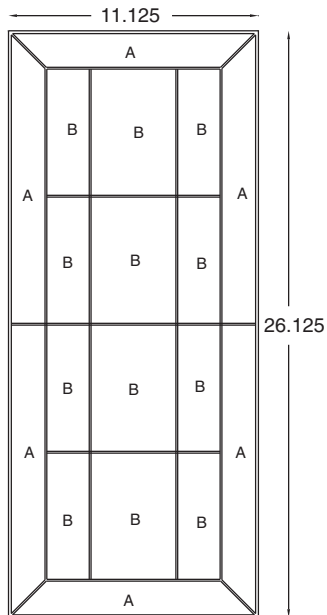

To Determine Vertical Break Placement:
Formats with 1" Borders = $(\text{Width} - 2.57) \times .25$
Formats with 1 1/2" Borders = $(\text{Width} - 3.57) \times .25$

Glass Types:
A) 1/8" Clear
B) Clear Artique 100A

Minimum Width 5 1/2"
Minimum Height 5 1/2"
Widths < 12" = 1" Borders

Metal Types:
3/16" H-CH Zinc PROGLAZE2 (All)

Specialty Doors

Bennington Patina

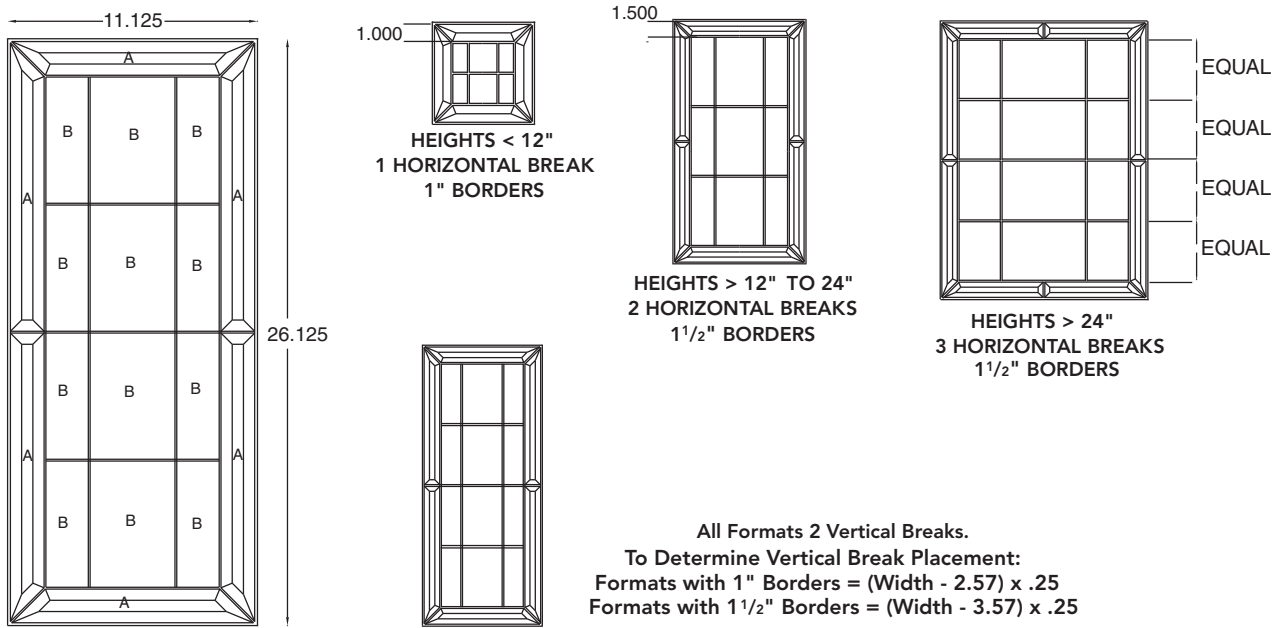

Glass Types:
A) 3/16" Clear W/1/2" Bevel
B) Clear Artique 100A

Metal Types:
3/16" H-CH Zinc PROGLAZE2 (All) Patina

Minimum Width 5 1/2"
Minimum Height 5 1/2"
Widths < 12" = 1" Borders

Delray

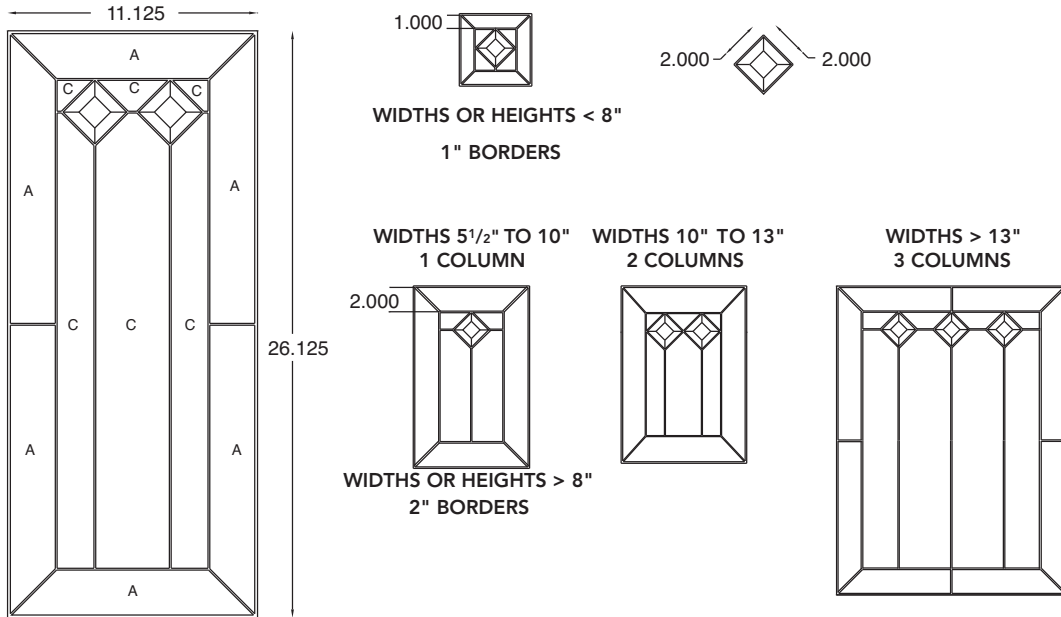

Glass Types:
A) Clear Sparkolite
B) 3/16" Clear W/1/2" Bevel
C) 1/8" Clear

Metal Types:
3/16" H-CH Zinc PROGLAZE2 (All)

Minimum Width 5 1/2"
Minimum Height 5 1/2"

Emery

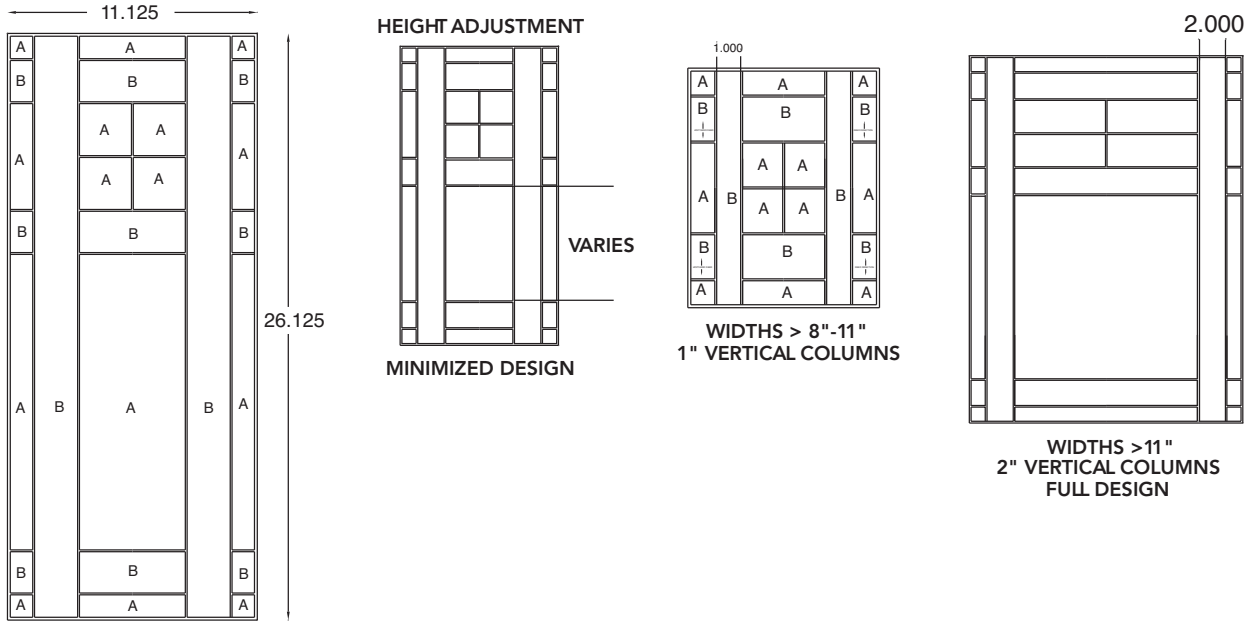

Glass Types:
 A) Clear Artique 100A
 B) Thin Reeded Clear 1/8" Reeds # 4034

Metal Types:
 3/16" H-CH Copper PROGLAZE2

Minimum Width 8"
 Minimum Height 10"
 (N/A in 9", 12", 15" Wide)
 (N/A in 12" & 15" High)

Foster

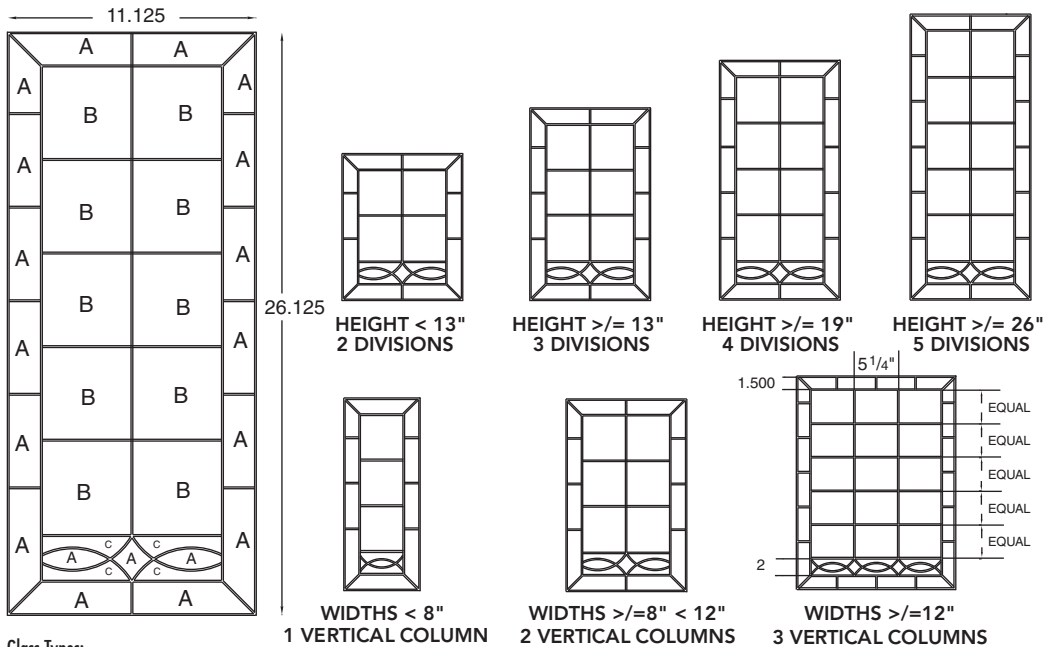

Glass Types:
 A) Clear & White, Translucent "Feather" 307S
 B) Clear Rough Rolled 100 RR
 C) Frost Etch 100W

Metal Types:
 3/16" H-CH Zinc PROGLAZE2 (All)

Minimum Width 5 1/2"
 Minimum Height 9"
 (N/A In 12"-15" High)

Specialty Doors

Merrimack

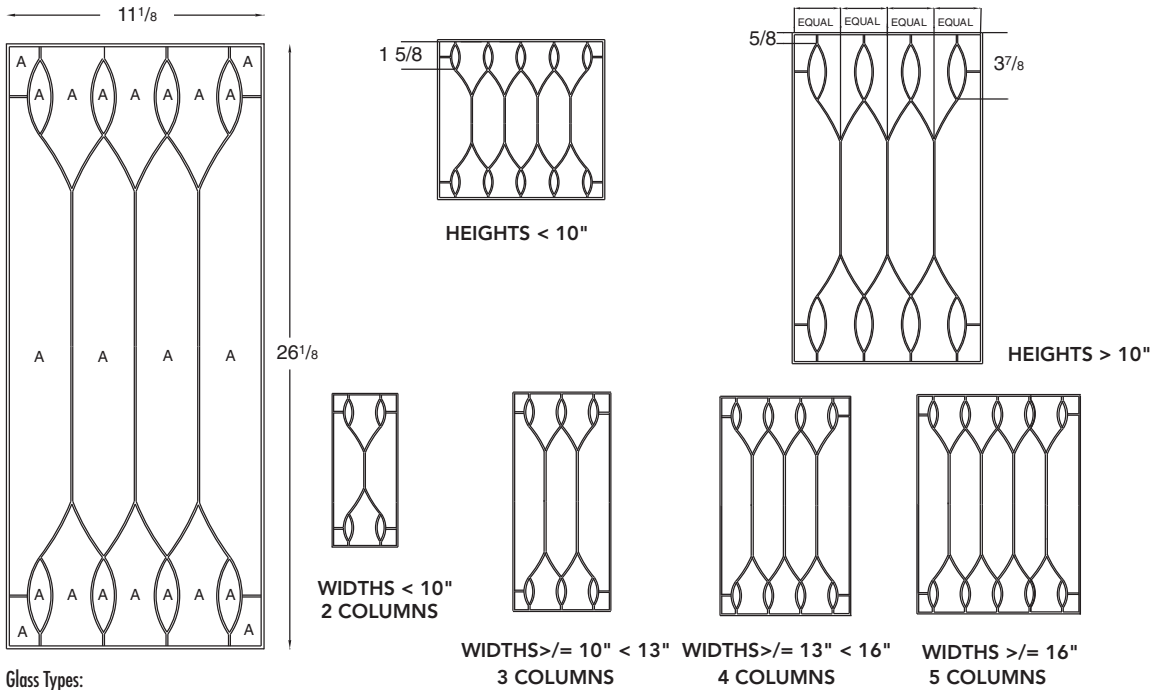

Glass Types:
A) Clear Baroque BR/CLR

Metal Types:
3/16" H-CH Zinc PROGLAZE2 (Patina)

Minimum Width 5 1/2"
Minimum Height 7"

Serafina

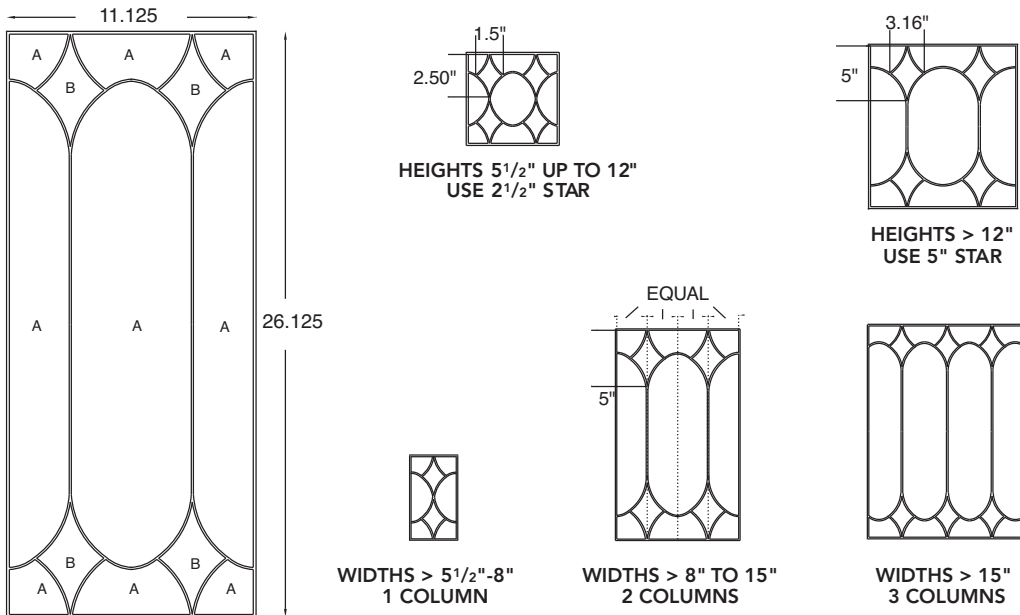

Glass Types:
A) Clear Artique 100-A
B) Clear Granite 100G

Metal Types:
3/16" H-CH Brass PROGLAZE2 (All)

Minimum Width 5 1/2"
Minimum Height 5 1/2"

Stratton

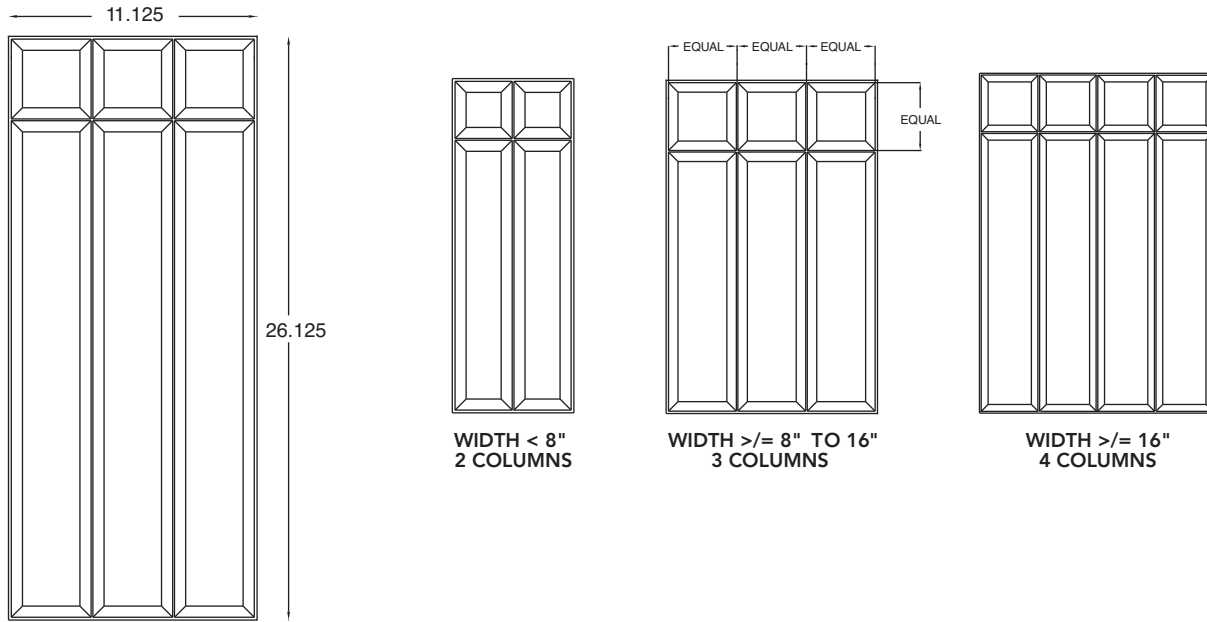

Glass Types:
A) 3/16" Clear W/1/2" Bevel (All)

Metal Types:
3/16" HC-H Brass PROGLAZE2 (All)

Minimum Width 5 1/2"
Minimum Height 5 1/2"

Waterbury

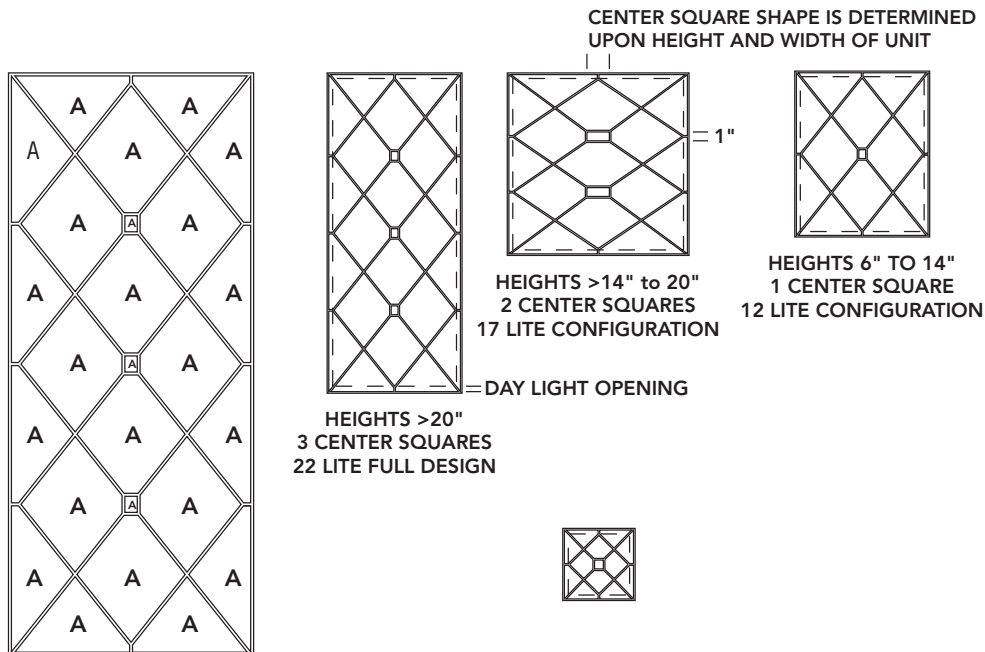

Glass Types:
A) Clear Waterglass 100W

Metal Types:
3/16" H-Ch Zinc Proglaze2 (all)
Black Patina Finish

Minimum Width 6"
Minimum Height 6"

Specialty Doors

Westerly

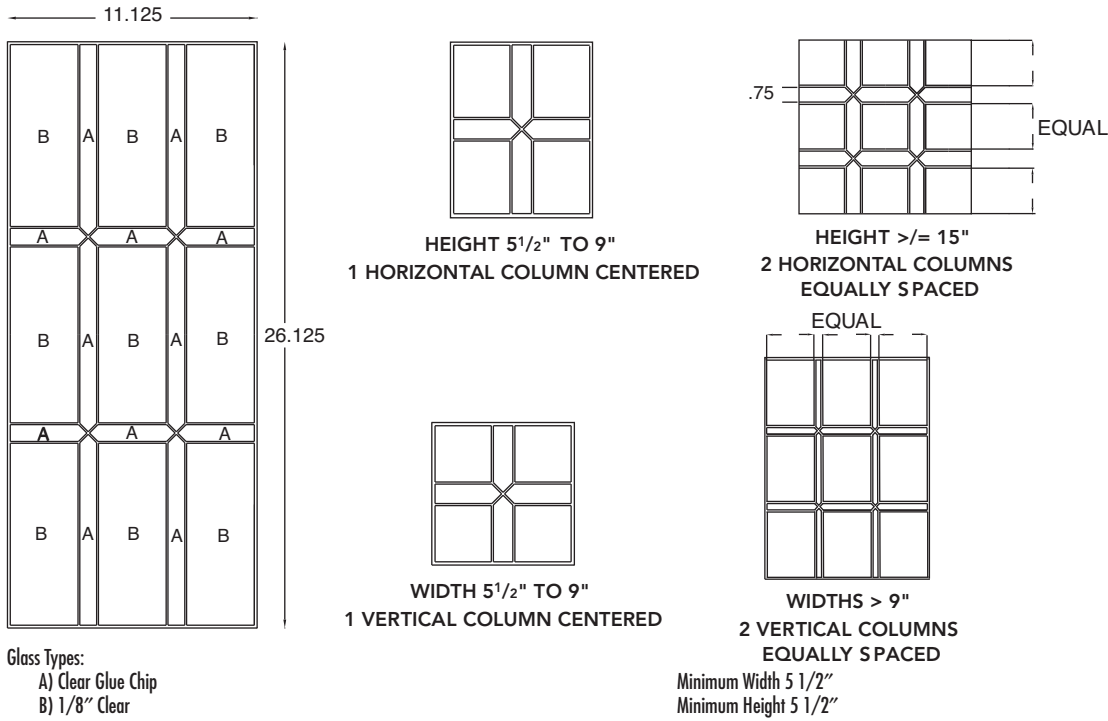

Wickford

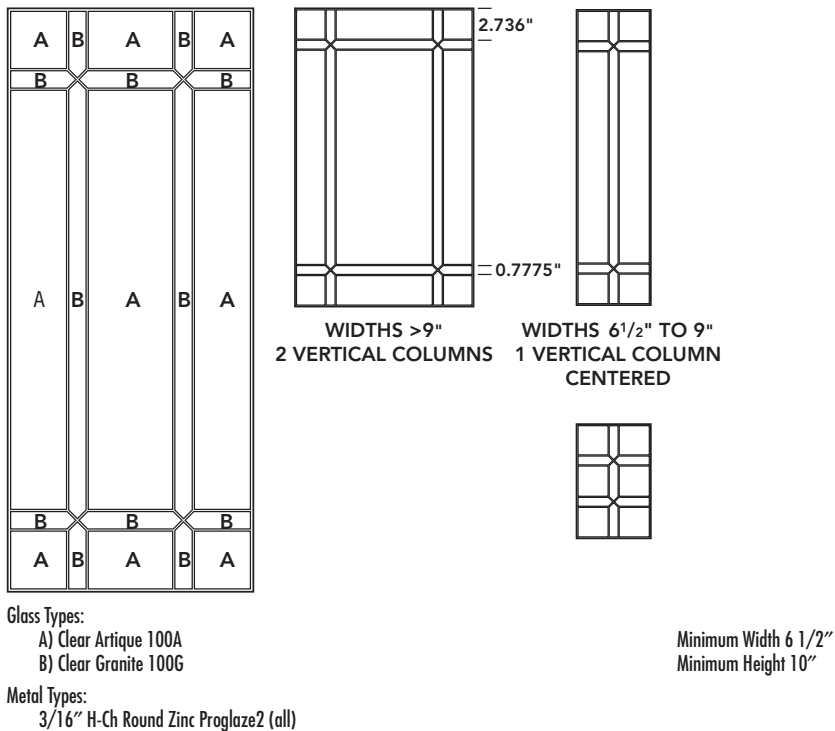

Winslet

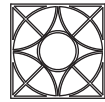
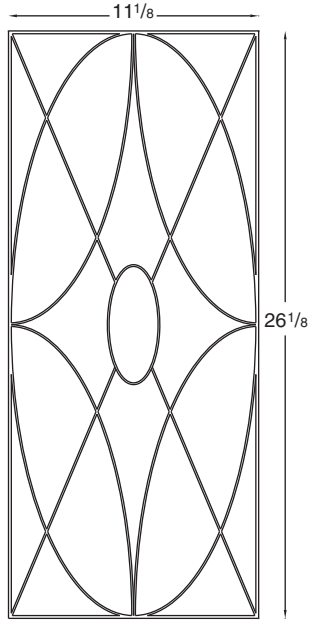

CENTER ELLIPSE
 $Y = \text{HEIGHT} \times .205$
 $X = \text{WIDTH} \times .205$

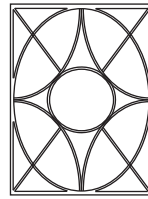

HEIGHTS < 10"
NO CENTER ELLIPSE

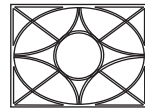

WIDTHS < 10"
NO CENTER ELLIPSE

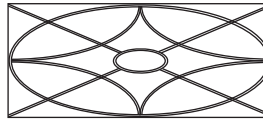

WIDTHS > 10"
CENTER ELLIPSE

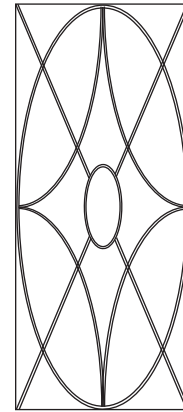

HEIGHTS > 10"
CENTER ELLIPSE

Glass Types:

A) 1/8" Clear Artique 100A (All)

Metal Types:

3/16" H-CH Zinc PROGLAZE2 (All) Patina

Minimum Width 5 1/2"
 Minimum Height 5 1/2"

Wright

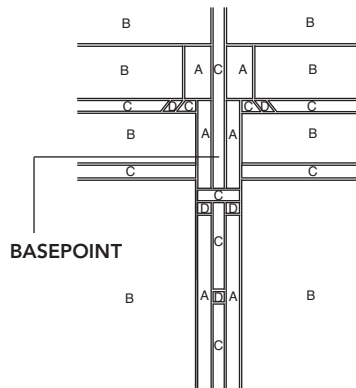
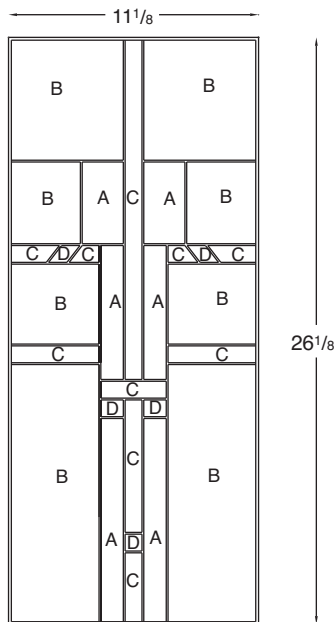

**COMPONENTS PLACED ON
 FORMAT MIDPOINT**

COMPONENT A
 WIDTHS 9" >
 HEIGHTS 10" & >

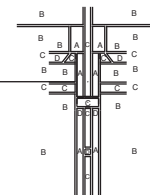
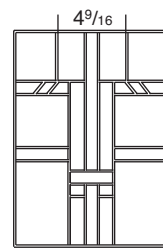
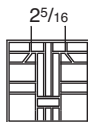

COMPONENT B
 WIDTHS < 9"
 HEIGHTS < 10"

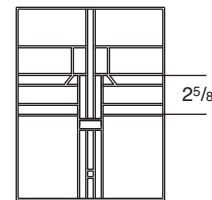
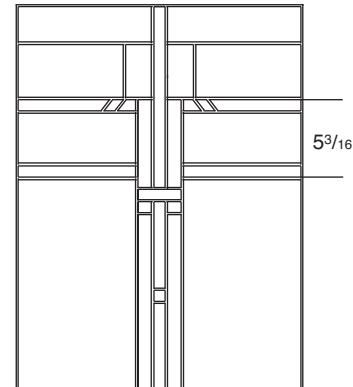

Glass Types:

A) Sparkolite (Crystal Ice)
 B) Clear Rough Rolled 100RR
 Clear Artique
 D) Light Amber and White Translucent 317-1S

Metal Types:

3/16" H-CH Zinc PROGLAZE2 (All) Patina

Minimum Width 5 1/2"
 Minimum Height 5 1/2"

Notes

LOGIX® REFERENCE CHART

Wall Cabinets	Description	3"	6"	9"	12"	15"	18"	19"	21"	24"	27"	30"	33"	36"	37"	39"	42"	45"	48"	54"	60"	72"	Page
W___24PO L or R, W___24PO	Wall Refrigerator Pull-out Cabinet													•	•	•							J•49
WBCPO___OL	Wall Box Column Pull-out (Plain, Overlay)	•	•																				J•103
WBCPOKCU	Wall Box Column Pull-out w/K-Cup	•																					J•105
WEAS___30 L or R, WEAS___30	Wall Easy Access Storage Cabinet					•	•					•		•									J•13
WMC___L or R	Wall Message Center	•																					J•90
WOBS___36	Wall Organizer & Bookshelf									•		•		•									J•92
WSP___	Wall Spice Pull-out Cabinet			•	•																		J•101
WSRC21___L or R	Wall Spice Rack Cabinet								•														J•102
WWR___30	Wall Cabinet w/Wine Rack									•		•		•									J•92
Hearths																							
HPP12___L or R	Hearth Pier Pull-out				•																		K•23
Base Cabinets																							
2DB___RT	Two Drawer Base w/Roll Trays						•		•	•	•	•	•	•									L•33
2DB36PDO	Two Drawer Base w/Pegged Dish Organizer													•									L•32
2DB36RTPDO	Two Drawer Base w/Roll Tray & Pegged Dish Organizer													•									L•33
3CDB36	Three Corner Drawer Base													•									L•78
3DB___WTCD	Three Drawer Base w/Wood Tiered Cutlery Divider				•	•			•	•		•		•									L•29
3DB18CHGDRW	Three Drawer Base w/Charging Drawer						•																L•31
3DB18KCUP	Three Drawer Base w/Wood Tiered K-Cup Drawer						•																L•30
4DB___CIW	Four Drawer Base w/Cutlery Insert Wood Dividers				•	•			•	•													L•26
4DB___WTCD	Four Drawer Base w/Wood Tiered Cutlery Divider				•	•			•	•		•		•									L•25
4DB18CHGDRW	Four Drawer Base w/Charging Drawer						•																L•27
4DB18KCUP	Four Drawer Base w/Wood Tiered K-Cup Drawer						•																L•26
B___CIW L or R, B24CIW	Base w/Cutlery Insert Wood Dividers				•	•			•	•													L•9
B___FHMIXSC L or R	Base w/Mixer Shelf						•		•	•													L•89
B___FSC L or R	Base w/Food Storage Container Organizer						•		•	•													L•11
B___PS	Base Pot & Pans Storage								•	•		•		•									L•35
B___PSB L or R	Base w/Plastic Storage Bins				•	•																	L•89
B___RTCIW L or R, B24RTCIW	Base w/Cutlery Insert Wood Dividers & Roll Trays				•	•			•	•													L•10
B___RTLO	Base w/Drawer & Lid Organizer & Roll Trays											•	•	•									L•36
B___RTWTCD L or R, B___RTWTCD	Base w/Wood Tiered Cutlery Divider & Roll Trays				•	•			•	•		•		•									L•8
B___SD L or R	Base w/Spice Drawer						•			•													L•94
B___TDRO L or R	Base w/Roll-out Tray Divider				•	•																	L•84
B___WTCD L or R, B___WTCD	Base w/Wood Tiered Cutlery Divider				•	•			•	•		•		•									L•7
B18CHGDRW L or R	Base w/Charging Drawer						•																L•5
B18CHGDRWRT L or R	Base w/Roll Trays & Charging Drawer						•																L•7
B18KCUP L or R	Base w/Wood Tiered K-Cup Drawer						•																L•10
B18KUPRT L or R	Base w/Wood Tiered K-Cup Drawer & Roll Trays						•																L•11
B72SDIDSK	Base Sliding Door Island Cabinet w/Sliding Desk																				•		L•79
BBCPO___OL	Base Box Column Pull-out (Plain, Overlay)	•	•																				L•90
BBS18 L or R	Base w/Bottle Storage						•																L•101
BC___PO L or R	Base Corner Pull-out																		•	•			L•61
BCC___BB	Base Cooking Center w/Bread Board											•		•					•	•			L•37
BCFW___CPO L or R	Base Corner Full Width w/Arched Pull-out																			•	•		L•63
BCFW___PO L or R	Base Corner Full Width Pull-out																			•	•		L•62
BCFW2D48CRVPO L or R	Two Drawer Base Corner Full Width w/Curve Pull-out																				•		L•66
BCFW48SP L or R	Base Corner Full Width w/Roll Trays & Swing-out																				•		L•63
BCFWFH___CPO L or R	Full Height Base Corner Full Width w/Arched Pull-out																				•	•	L•64
BCFWFH48CRVPO L or R	Full Height Base Corner Full Width w/Curve Pull-out																				•		L•66
BCOPP12	Base Container Organization Pantry				•																		L•94
BMC24 L or R	Base Message Center	•																					L•109
BPCS36	Base Pantry Can Storage													•									L•37
BPP___	Base Pantry Pull-out			•	•	•	•																L•91
BPPP24 L or R, BPPP___	Base Pots & Pans Pull-out									•		•											L•35
BRDB36 L or R	Base Rotating Deep Bin													•									L•77

•Available widths

Base Cabinets (cont'd)	Description	3"	6"	9"	12"	15"	18"	19"	21"	24"	27"	30"	33"	36"	37"	39"	42"	45"	48"	54"	60"	72"	Page	
BSC30 PR, R, RP, RS, SR	Base SuperCabinet™											•											L•20	
BSC36 PRP, PRS, SRP, SRS	Base SuperCabinet™													•										L•21
BSP__PG	Base Spice Pull-out				•	•																		L•92
BTDPP__	Base Tray Divider Pantry Pull-out				•	•																		L•93
BUPP__	Base Utensil Pantry Pull-out				•	•																		L•92
BUPPKB__	Base Utensil Pantry Pull-out w/Knife Block				•	•																		L•93
BWB__	Base Wastebasket					•	•		•	•														L•95
BWB__BB	Base Wastebasket w/Bread Board					•	•		•	•														L•97
BWB__FH	Base Wastebasket Full Height					•	•		•	•														L•96
BWB__FHRT2	Base Wastebasket Full Height w/Roll Tray					•	•		•	•														L•97
BWB__WTC	Base Wastebasket w/Wood Tiered Cutlery Divider					•	•		•	•														L•98
BWB18CHGDRW	Base Wastebasket w/Charging Drawer						•																	L•99
BWB18KUCUP	Base Wastebasket w/Wood Tiered K-Cup Drawer						•																	L•98
CNTYSB__CM	Country Sink Base w/CabMat™											•	•	•										L•49
SB__CM	Sink Base Double Door w/CabMat™											•	•	•										L•39
SB__S	Sink Base SuperCabinet™											•	•	•										L•45
SB__SCM	Sink Base SuperCabinet™ w/CabMat™											•	•	•										L•46
SB__STCM	Sink Base w/Tilt-out Trays & CabMat™											•	•	•										L•42
SB__STS	Sink Base SuperCabinet™ w/Tilt-out Tray											•	•	•										L•46
SB__STSCM	Sink Base SuperCabinet™ w/Tilt-out Trays & CabMat™											•	•	•										L•47
SB36CDY L or R	Sink Base Double Door w/Caddy													•										L•39
SB36SCDY L or R	Sink Base SuperCabinet™ w/Caddy													•										L•45
SB36STCDY L or R	Sink Base w/Tilt-out Tray & Caddy													•										L•42
SB36STSCDY L or R	Sink Base SuperCabinet™ w/Tilt-out Tray & Caddy													•										L•47
SLSCR____L or R	Super Lazy Susan w/Chrome Rail													•	•									L•76
SLSCR__RS L or R	Super Lazy Susan w/Chrome Rail & Reduced Shelf													•	•									L•72
SLSCR36CD L or R	Super Lazy Susan w/Chrome Rail & Corner Drawer													•										L•77
Tall Cabinets																								
PY36__24	Pantry Unit																							M•29
TPP____24, TPP____24 L or R	Tall Pantry Pull-out				•	•	•	•																M•26
UOC24____L or R, UOC24____	Utility Organizer Cabinet																							M•31
UOCDZ24__9	Utility Organizer Drop Zone Cabinet																							M•39
Vanity Cabinets																								
6VSDB____21WTV L or R, 6VSDB____21WTV	Vanity Console Drawer Base w/Six Drawers & Wood Tiered Vanity Drawer																	•		•	•	•		P•36
LCRH188421 L or R	Linen Closet w/Removable Hamper																							P•51
VBP1234.5	Vanity Base Pull-out					•																		P•13
Modifications																								
CMAT1	CabMat™												•	•	•									G•37
CMAT2	CabMat™													•	•	•	•	•						G•37
DRWTK	Toekick Drawer				•	•	•			•	•	•	•	•	•									G•30

•Available widths

How to Use Your Diamond Edge Price List









Your Diamond Edge price guide contains charts with prices for each cabinetry product, arranged according to an alphabetical code. Use the chart below to determine the price code for your preferred cabinetry style.

Then refer to the various sections of this binder to find the types and sizes of cabinets required. Read across each chart to the column that corresponds to your style's price code to determine the price for each unit.

All Wall Cabinets are 12" deep unless otherwise noted.

For example, if you want a wall cabinet that is 12" wide and 30" high in the Karis Cherry style, you would

- Find the price code for Karis Cherry ("3" in the chart below)
- Refer to the "Wall Cabinets" section of this binder
- Locate product code W1230 L or R (W = wall, 12 = width in inches, 30 = height in inches)
- Read across the chart in the same row to column 3 to find the price for this model in Karis Cherry

Door Styles	Alder	Cherry	Maple	MDF	Quartersawn Oak	Rustic Alder	Walnut
Brooks	3	5	3		5	3	6
Brooks Beaded Inset	3+15%	5+15%	3+15%		5+15%	3+15%	6+15%
Brooks Inset	3+15%	5+15%	3+15%		5+15%	3+15%	6+15%
Caldera 	3	5	3		5	3	6
Daxton	2	4	2		4	2	6
Daxton Beaded Inset	2+15%	4+15%	2+15%		4+15%	2+15%	6+15%
Daxton Inset	2+15%	4+15%	2+15%		4+15%	2+15%	6+15%
Gunther	1	3	1		3	1	5
Gunther Beaded Inset	1+15%	3+15%	1+15%		3+15%	1+15%	5+15%
Gunther Inset	1+15%	3+15%	1+15%		3+15%	1+15%	5+15%
Karis	1	3	1		3	1	5
Karis Beaded Inset	1+15%	3+15%	1+15%		3+15%	1+15%	5+15%
Karis Inset	1+15%	3+15%	1+15%		3+15%	1+15%	5+15%
Langley	5	6	5		6	5	7
Langley Beaded Inset	5+15%	6+15%	5+15%		6+15%	5+15%	7+15%
Langley Inset	5+15%	6+15%	5+15%		6+15%	5+15%	7+15%
Montgomery 	1	3	1		3	1	5
Montgomery Beaded Inset 	1+15%	3+15%	1+15%		3+15%	1+15%	5+15%
Montgomery Inset 	1+15%	3+15%	1+15%		3+15%	1+15%	5+15%
Shona	1	3	1		3	1	5
Shona Beaded Inset	1+15%	3+15%	1+15%		3+15%	1+15%	5+15%
Shona Inset	1+15%	3+15%	1+15%		3+15%	1+15%	5+15%
Sumner 	3	5	3		5	3	6
Tackett	2	4	2		4	2	6
Tackett Beaded Inset	2+15%	4+15%	2+15%		4+15%	2+15%	6+15%
Tackett Inset	2+15%	4+15%	2+15%		4+15%	2+15%	6+15%
Trystan 	4	6	4	1	6		7
Trystan Beaded Inset 				1+15%			
Trystan Inset 				1+15%			
Vesta	2	4	2		4	2	6
Vesta Beaded Inset	2+15%	4+15%	2+15%		4+15%	2+15%	6+15%
Vesta Inset	2+15%	4+15%	2+15%		4+15%	2+15%	6+15%
Wells 	4	6	4		6	4	7

Diamond Edge Modification Option Descriptions

Your Diamond Edge price guide contains charts with modification option codes for each applicable cabinetry product. Reference the listing below to identify the modification description.

Door & Drawer Options	
Option	Description
AF	Aluminum Door
AOMD	Automatic Opening Mechanism for Lift Up System
CC	Craftsman Door
CG	Cut-for-glass
GAMD	Gallery Mullion Door
HC	Horizon Door
IFHG	Inset Finial Hinges
MC	Mission Door
MD	Mullion Door
MFO	Modified Full Overlay
PRMD	Prairie Mullion Door
SHMD	Shaker Mullion Door
SPLITDR	Split Doors
SPLITDRWS	Split Drawers
TCG	Transom w/Top Cut-for-glass and Bottom Center Panel
TCP	Transom w/both sections Center Panels

End Panel Options	
Option	Description
AUTH	Authentic Flush End
CSFPE	Car Siding Flush Panel End
EXBK	End Extended Back
EXDN	Wall End and Back Extended Down
FFD	Face Frame and Door on End
FL/FR	Finished Ends
FPE	Flush Panel End
INTGE	Integral End
IPE	Inset Panel Ends

Custom Modification Options	
Option	Description
ADD_SHLF	Add Shelf
ADDTK	Add Toekick
ADRW	Add Drawer Below Wall Unit
BVR	Bottom Valance Rail
CBO	Cabinet Box Only
CCO	Cabinet Case Only
CFNTO	Cabinet Front Only
CFRMO	Cabinet Frame Only
CLIP	Clipped Corner
CND	Cabinet No Door
CSDGBK	Car Siding Back
EX	Extended Stile
EX_OL	Extended Stile with Overlay
F.ALL	Finished All
FBFL	Finished Blind
FLUT	Fluting
FTK	Flush Toekick
ID	Increased Depth
IH	Increased Height
INVFRM	Inverted Frame
IW	Increased Width
LIGHT	Lighting
MIP	Matching Interior
OBRB	Open Bottom Rail Base
PFINBTMB	Finished Bottom
RD	Reduced Depth
RECTK	Recessed Toekick
RH	Reduced Height
ROSEFLUT	Rose Fluting
RT	Roll Trays
RW	Reduced Width
STW	Stacked Wall Cabinet Heights
TD	Tray Divider
TKP	Toekick Pedestal
TVR	Top Valance Rail
WS	Wide Stiles
WTR	Wide Top Rail

WALL, 12" HIGH

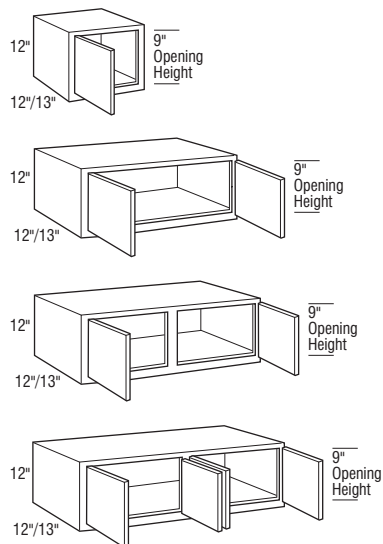

	Cubic Feet	1	2	3	4	5	6	7
W912 L or R	1.2	662	696	720	765	812	886	960
W1212 L or R	1.5	698	733	760	807	849	931	1013
W1512 L or R	1.9	732	768	793	843	880	969	1058
W1812 L or R	2.2	776	817	846	892	953	1046	1139
W2112 L or R	2.5	793	837	870	915	966	1059	1152
W2412 L or R	2.9	811	854	884	935	980	1075	1170
W2112	2.5	863	906	940	992	1045	1145	1245
W2412	2.9	914	958	996	1048	1110	1215	1320
W2712	3.2	998	1044	1080	1142	1207	1321	1435
W3012	3.6	1075	1127	1171	1233	1303	1431	1559
W3312	3.9	1113	1171	1215	1281	1351	1476	1601
W3412	3.8	1132	1193	1236	1305	1376	1503	1630
W3612	4.2	1150	1215	1256	1329	1400	1529	1658
W3712	4.1	1171	1230	1275	1346	1419	1548	1677
W3912	4.6	1192	1244	1293	1362	1438	1567	1696
W4212CS	4.9	1220	1281	1332	1404	1491	1630	1769
W4512CS	5.3	1405	1470	1532	1613	1715	1872	2029
W4212	4.9	1379	1448	1505	1587	1685	1842	1999
W4512	5.3	1588	1661	1731	1823	1938	2115	2292
W4812	5.6	1514	1582	1646	1736	1846	2014	2182

Notes below apply to all products in section above:

- Inset and Beaded Inset Door Styles are a standard 13" deep.
- Full Overlay Styles:
 - Increased Depths available in 1/4" increments from 12 1/4" to 30".
 - Reduced Depths available in 1/4" increments from 6" to 11 3/4".
- Inset and Beaded Inset Styles:
 - Increased Depths available in 1/4" increments from 13 1/4" to 30".
 - Reduced Depths available in 1/4" increments from 6" to 12 3/4".

Door & Drawer Options

AF	AOMD	CC ¹	CG	GAMD	HC	IFHG	MC	MD	MFO	PRMD	SHMD	SPLITDR ²	SPLITDRWS	TCG	TCP
✓	✓	✓	✓	✓	✓	✓	✓	✓	✓	✓	✓	✓	✓	✓	✓

End Panel Options

AUTH	CSFPE	EXBK	EXDN	FFD	FL/FR	FPE	INTGE	IPE
✓	✓	✓	✓	✓	✓	✓	✓	✓

Custom Modification Options

ADD_SHLF	ADDTK	ADRW	BVR	CBO	CCO	CFNTO	CFRMO	CLIP ³	CND	CSDGBK	EX	EX_OL	FALL	FBFL	FLUT ⁴	FTK ⁵	ID	IH
✓	✓	✓	✓	✓	✓	✓	✓	✓	✓	✓	✓	✓	✓	✓	✓	✓	✓	✓

INVERM	IW ⁶	LIGHT	MIP	OBRB	PFINBTMB	RD	RECTK	RH	ROSFLUT	RT ⁷	RW	STW	TD	TKP	TVR ⁸	WS	WTR
✓	✓	✓	✓	✓	✓	✓	✓	✓	✓	✓	✓	✓	✓	✓	✓	✓	✓

¹ Not available on 9" or 12" wide.
² Only available on 21"/24" (2 doors)-39" wide.
³ Not available on 9", 12" or 24" (2 doors) wide.
⁴ Not available with 6" fluting.
⁵ FTKAV and style B-L not available on 9" or 12" wide.
⁶ Not available on 24" (1 door), 21" (2 door), or 48" wide.
⁷ Not available on 9" or 39" wide.
⁸ Not available on 42"-48" wide and TVRAV and style B-L not available on 9" or 12" wide.

Wall Cabinets

	Cubic Feet	1	2	3	4	5	6	7
WALL, 15" HIGH	W915 L or R	1.5	662	696	720	765	812	860
	W1215 L or R	1.9	698	733	760	807	849	1013
	W1515 L or R	2.3	732	768	793	843	880	1058
	W1815 L or R	2.7	776	817	846	892	953	1139
	W2115 L or R	3.1	793	837	870	915	966	1059
	W2415 L or R	3.5	811	854	884	935	980	1075
	W2115	3.1	945	996	1030	1091	1142	1254
	W2415	3.5	1078	1137	1175	1247	1303	1433
	W2715	3.9	1106	1160	1201	1270	1327	1457
	W3015	4.4	1131	1188	1226	1297	1352	1480
	W3315	4.8	1177	1233	1278	1341	1410	1543
	W3415	4.6	1196	1253	1300	1367	1434	1565
	W3615	5.2	1215	1272	1321	1393	1457	1586
	W3715	5.0	1237	1297	1348	1420	1488	1621
	W3915	5.6	1258	1322	1374	1447	1519	1656
	W4215CS	6.0	1290	1351	1404	1485	1557	1703
W4515CS	6.4	1402	1469	1527	1610	1700	1858	
W4815CS	6.9	1460	1534	1584	1679	1765	1929	
W4215	6.0	1458	1527	1587	1678	1759	1924	
W4515	6.4	1584	1660	1726	1819	1921	2100	
W4815	6.9	1650	1733	1790	1897	1994	2180	

Notes below apply to all products in section above:

- Inset and Beaded Inset Door Styles are a standard 13" deep.
- Full Overlay Styles:
 - Increased Depths available in 1/4" increments from 12 1/4" to 30".
 - Reduced Depths available in 1/4" increments from 6" to 11 3/4".
- Inset and Beaded Inset Styles:
 - Increased Depths available in 1/4" increments from 13 1/4" to 30".
 - Reduced Depths available in 1/4" increments from 6" to 12 3/4".

Door & Drawer Options

AF	AOMD	CC ¹	CG	GAMD ²	HC	IFHG	MC	MD	MFO	PRMD	SHMD ¹	SPLITDR ³	SPLITDRWS	TCG	TCP
✓	✓	✓	✓	✓	✓	✓	✓	✓	✓	✓	✓	✓	✓	✓	✓

End Panel Options

AUTH	CSFPE	EXBK	EXDN	FFD	FL/FR	FPE	INTGE	IPE
✓	✓	✓	✓	✓	✓	✓	✓	✓

Custom Modification Options

ADD_SHLF	ADDTK	ADRW	BVR	CBO	CCO	CFNTO	CFRMO	CLIP ⁴	CND	CSDGBK	EX_EX_OL	FALL	FBFL	FLUT ⁵	FTK ⁶	ID	IH
✓	✓	✓	✓	✓	✓	✓	✓	✓	✓	✓	✓	✓	✓	✓	✓	✓	✓

INVRM	IW ⁷	LIGHT	MIP	OBRB	PFINBTMB	RD	RECTK	RH	ROSLUT	RT ⁸	RW	STW	TD	TKP	TVR ⁹	WS	WTR
✓	✓	✓	✓	✓	✓	✓	✓	✓	✓	✓	✓	✓	✓	✓	✓	✓	✓

¹ Not available on 9" wide.
² Not available on 9" or 12" wide.
³ Only available on 24" (2 doors)-39" wide.
⁴ Not available on 9", 12" or 24" (2 doors) wide.
⁵ Not available with 6" fluting.
⁶ FTKAV and style B-L not available on 9" or 12" wide.
⁷ Not available on 24" (1 door), 21" (2 door), or 48" wide.
⁸ Not available on 9" or 39" wide.
⁹ Not available on 42"-48" wide and TVRAV and style B-L not available on 9" or 12" wide.

IH/RH availability charts starting on page G-40.
 IW/RW availability charts starting on page G-46.

WALL TOP HINGE with VERTICAL-LIFT and STAY LIFT, 15", 18", or 21" HIGH

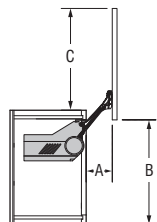
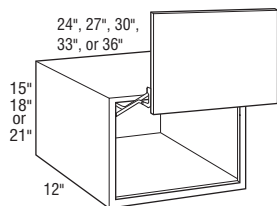

	Cubic Feet	1	2	3	4	5	6	7
WVL2415	3.5	1954	2052	2123	2238	2374	2594	2814
WVL2715	3.9	1994	2091	2164	2278	2415	2637	2859
WVL3015	4.4	2035	2132	2206	2319	2455	2678	2901
WVL3315	4.8	2075	2174	2246	2361	2497	2719	2941
WVL3615	5.2	2117	2214	2287	2401	2538	2759	2980
WVL2418	4.2	2033	2134	2212	2331	2470	2701	2932
WVL2718	4.7	2074	2175	2254	2373	2511	2743	2975
WVL3018	5.2	2116	2216	2293	2414	2551	2784	3017
WVL3318	5.6	2156	2257	2334	2454	2591	2824	3057
WVL3618	6.1	2197	2298	2375	2494	2631	2865	3099
WVL2421	4.8	2197	2297	2372	2482	2619	2847	3075
WVL2721	5.4	2238	2337	2412	2523	2660	2887	3114
WVL3021	5.9	2278	2378	2453	2564	2700	2928	3156
WVL3321	6.5	2319	2419	2492	2607	2742	2968	3194
WVL3621	7.1	2361	2459	2534	2646	2783	3010	3237

- Not available on Inset and Beaded Inset door styles.
- Grain on center panels and slab doors will run horizontally and door rail configuration on non-miter doors will be unique from adjacent cabinet doors.
- Automatic Opening Mechanism is available except when used with the following door styles:
 - Brooks, Gunther, Karis, Langley, Montgomery, Shona, or Vesta.
- AOMD option not available with Aluminum Door profiles AF003 and AF006.
- Additional accessories available for Automatic Opening Mechanism option, refer to page S-13.

	Cabinet Height	A	B	C
Full Overlay	15"	5 3/4"	13 13/16"	13 3/8"
	18"	8 1/4"	20 13/16"	20 3/8"
	21"	7"	17 5/16"	16 7/8"

Door & Drawer Options

AF	AOMD	CC	CG	GAMD	HC	IFHG	MC	MD	MFO	PRMD	SHMD	SPLITDR	SPLITDRWS	TCG	TCP
✓	✓	✓	✓						✓				✓		

End Panel Options

AUTH	CSFPE	EXBK	EXDN	FFD	FL/FR	FPE	INTGE	IPE
✓	✓	✓	✓	✓	✓	✓	✓	✓

Custom Modification Options

ADD	SHLF	ADDTK	ADRW	BVR	CBO	CCO	CFNTD	CFRMO	CLIP	CND	CSDGBK	EX	EX_OL	FALL	FBFL	FLUT ¹	FTK	ID	IH ²
				✓	✓				✓	✓	✓	✓	✓	✓	✓	✓	✓	✓	✓

INVFRM	IW ³	LIGHT	MIP	OBRB	PFINBTMB	RD	RECTK	RH	ROSLUT	RT	RW	STW	TD	TKP	TVR	WS ⁴	WTR
✓	✓	✓	✓	✓	✓	✓			✓							✓	✓

¹ Not available with 6" fluting.

² Not available on 21" high.

³ Not available on 36" wide.

⁴ 18" high only available with wide stile both.

Wall Cabinets

WALL TOP HINGE with VERTICAL-LIFT and STAY LIFT, 18" or 21" HIGH

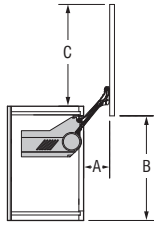
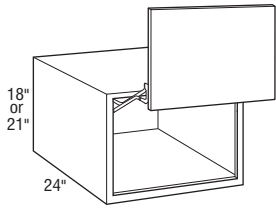

	Cubic Feet	1	2	3	4	5	6	7
WVL301824	9.4	2116	2216	2293	2414	2551	2784	3017
WVL361824	11.2	2197	2298	2375	2494	2631	2865	3099
WVL302124	10.9	2278	2378	2453	2564	2700	2928	3156
WVL362124	12.9	2361	2459	2534	2646	2783	3010	3237

- Not available on Inset and Beaded Inset door styles.
- Grain on center panels and slab doors will run horizontally and door rail configuration on non-miter doors will be unique from adjacent cabinet doors.
- Automatic Opening Mechanism is available except when used with the following door styles:
 - Brooks, Gunther, Karis, Langley, Montgomery, Shona, or Vesta.
- AOMD option not available with Aluminum Door profiles AF003 and AF006.
- Additional accessories available for Automatic Opening Mechanism option, refer to page S•13.

	Cabinet Height	A	B	C
Full Overlay	18"	8 1/4"	20 13/16"	20 3/8"
	21"	7"	17 5/16"	16 7/8"

Door & Drawer Options

AF	AOMD	CC	CG	GAMD	HC	IFHG	MC	MD	MFO	PRMD	SHMD	SPLITDR	SPLITDRWS	TCG	TCP
✓	✓	✓	✓	✓	✓	✓	✓	✓	✓	✓	✓	✓	✓	✓	✓

End Panel Options

AUTH	CSFPE	EXBK	EXDN	FFD	FL/FR	FPE	INTGE	IPE
✓	✓	✓	✓	✓	✓	✓	✓	✓

Custom Modification Options

ADD	SHLF	ADTK	ADRW	BVR	CBO	CCO	CFNTD	CFRMO	CLIP	CND	CSDGBK	EX	EX_OL	F.ALL	FBFL	FLUT ¹	FTK	ID	IH ²
✓	✓	✓	✓	✓	✓	✓	✓	✓	✓	✓	✓	✓	✓	✓	✓	✓	✓	✓	✓

INVERM	IW ³	LIGHT	MIP	OBRB	PFINBTMB	RD	RECTK	RH	ROSLUT	RT	RW	STW	TD	TKP	TVR	WS	WTR
✓	✓	✓	✓	✓	✓	✓	✓	✓	✓	✓	✓	✓	✓	✓	✓	✓	✓

¹ Not available with 6" fluting.

² Not available on 21" high.

³ Not available on 36" wide.

IH/RH availability charts starting on page G•40.
IW/RW availability charts starting on page G•46.

WALL, 18" or 21" HIGH

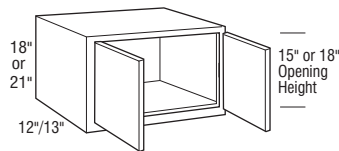
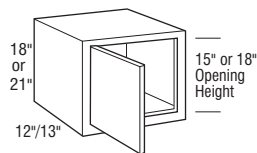

	Cubic Feet	1	2	3	4	5	6	7
W918 L or R	1.7	662	696	720	765	812	886	960
W1218 L or R	2.2	698	733	760	807	849	931	1013
W1518 L or R	2.7	732	768	793	843	880	969	1058
W1818 L or R	3.2	776	817	846	892	953	1046	1139
W2118 L or R	3.7	793	837	870	915	966	1059	1152
W2418 L or R	4.2	818	854	889	934	979	1069	1159
W921 L or R	2.0	677	714	737	779	829	905	981
W1221 L or R	2.5	716	748	776	821	867	950	1033
W1521 L or R	3.1	747	782	811	864	902	987	1072
W1821 L or R	3.7	793	837	866	908	969	1060	1151
W2121 L or R	4.2	811	854	884	935	980	1075	1170
W2421 L or R	4.8	859	900	931	979	1046	1139	1232

W2418	4.2	1032	1080	1111	1175	1246	1357	1468
W2718	4.7	1133	1192	1230	1299	1357	1485	1613
W3018	5.2	1187	1241	1287	1351	1431	1564	1697
W3318	5.6	1220	1281	1332	1404	1491	1630	1769
W3418	5.5	1250	1311	1361	1432	1517	1656	1795
W3618	6.1	1279	1340	1389	1460	1543	1682	1821
W3718	6.0	1307	1370	1418	1494	1584	1728	1872
W3918	6.6	1335	1400	1447	1527	1624	1773	1922
W2421	4.8	1107	1163	1192	1262	1340	1468	1596
W2721	5.4	1187	1242	1287	1358	1429	1560	1691
W3021	5.9	1233	1293	1340	1409	1490	1630	1770
W3321	6.5	1278	1338	1389	1460	1556	1701	1846
W3421	6.4	1305	1368	1416	1492	1583	1725	1867
W3621	7.1	1332	1397	1442	1524	1610	1749	1888
W3721	6.9	1361	1426	1472	1552	1641	1786	1931
W3921	7.6	1389	1455	1501	1580	1672	1823	1974

Notes below apply to all products in section above:

- Inset and Beaded Inset Door Styles are a standard 13" deep.
- Full Overlay Styles:
 - Increased Depths available in 1/4" increments from 12 1/4" to 30".
 - Reduced Depths available in 1/4" increments from 6" to 11 3/4".
- Inset and Beaded Inset Styles:
 - Increased Depths available in 1/4" increments from 13 1/4" to 30".
 - Reduced Depths available in 1/4" increments from 6" to 12 3/4".

Door & Drawer Options

AF	AOMD	CC ¹	CG	GAMD ¹	HC	IFHG	MC	MD ¹	MFO	PRMD ²	SHMD ¹	SPLITDR ³	SPLITDRWS	TCG	TCP
✓	✓	✓	✓	✓	✓	✓	✓	✓	✓	✓	✓	✓	✓	✓	✓

End Panel Options

AUTH	CSFPE	EXBK	EXDN	FFD	FL/FR	FPE	INTGE	IPE
✓	✓	✓	✓	✓	✓	✓	✓	✓

Custom Modification Options

ADD_SHLF	ADDTK	ADRW	BVR	CBO	CCO	CFNTD	CFRMO	CLIP ⁴	CND	CSDGBK	EX	EX_OL	FALL	FBFL	FLUT ⁵	FTK ⁶	ID	IH
✓	✓	✓	✓	✓	✓	✓	✓	✓	✓	✓	✓	✓	✓	✓	✓	✓	✓	✓

INVERM	IW ⁷	LIGHT	MIP	OBRB	PFINBTMB	RD	RECTK	RH	ROSLUT	RT ⁸	RW	STW	TD	TKP	TVR ⁹	WS	WTR
✓	✓	✓	✓	✓	✓	✓	✓	✓	✓	✓	✓	✓	✓	✓	✓	✓	✓

¹ Not available on 9" wide.

² Not available on 9", 12" or 24" (2 doors) wide.

³ Only available on 24" (2 doors)-39" wide.

⁴ Not available on the 9", 12" or 24" (2 doors) wide.

⁵ Not available with 6" fluting.

⁶ FTKAV and style B-L not available on 9" or 12" wide.

⁷ Not available on 24" (1 door) wide.

⁸ Not available on the 9" or 39" wide.

⁹ Not available on 42"-48" wide and TVRAV and style B-L not available on 9" or 12" wide.

Wall Cabinets

WALL, 18" or 21" HIGH (cont'd)

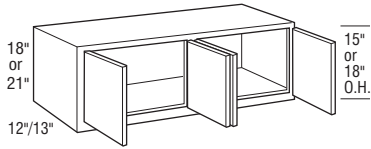
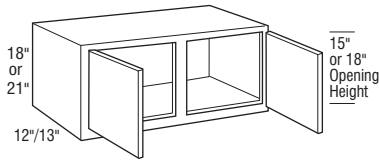

	Cubic Feet	1	2	3	4	5	6	7
W4218	7.1	1400	1466	1522	1608	1680	1843	2006
W4518	7.6	1402	1469	1527	1610	1700	1858	2016
W4818CS	8.1	1476	1549	1605	1699	1780	1947	2114
W4221	8.2	1458	1533	1583	1673	1760	1924	2088
W4521	8.8	1539	1613	1673	1765	1864	2038	2212
W4821CS	9.3	1613	1691	1752	1851	1946	2126	2306

W4818	8.1	1668	1750	1814	1920	2011	2200	2389
W4821	9.3	1823	1911	1980	2092	2199	2402	2605

- Inset and Beaded Inset Door Styles are a standard 13" deep.
- Full Overlay Styles:
 - Increased Depths available in 1/4" increments from 12 1/4" to 30".
 - Reduced Depths available in 1/4" increments from 6" to 11 3/4".
- Inset and Beaded Inset Styles:
 - Increased Depths available in 1/4" increments from 13 1/4" to 30".
 - Reduced Depths available in 1/4" increments from 6" to 12 3/4".

Door & Drawer Options

AF	AOMD	CC	CG	GAMD	HC	IFHG	MC	MD	MFO	PRMD	SHMD	SPLITDR	SPLITDRWS	TCG	TCP
✓	✓	✓	✓	✓	✓	✓	✓	✓	✓	✓	✓				

End Panel Options

AUTH	CSFPE	EXBK	EXDN	FFD	FL/FR	FPE	INTGE	IPE
✓	✓	✓	✓	✓	✓	✓	✓	✓

Custom Modification Options

ADD_SHLF	ADDTK	ADRW	BVR	CBO	CCO	CFNTO	CFRMO	CLIP	CND	CSDGBK	EX	EX_OL	F.ALL	FBFL	FLUT ¹	FTK	ID	IH
	✓	✓	✓	✓	✓	✓	✓	✓	✓	✓	✓	✓	✓		✓	✓	✓	✓

INVFRM	IW ²	LIGHT	MIP	OBRB	PFINBTMB	RD	RECTK	RH	ROSLUT	RT	RW	STW	TD	TKP	TVR	WS	WTR
	✓	✓	✓	✓	✓	✓			✓	✓		✓		✓		✓	✓

¹ Not available with 6" fluting.

² Not available on 48" wide.

IH/RH availability charts starting on page G•40.
IW/RW availability charts starting on page G•46.

WALL TOP HINGE with STAY LIFT, 9", 12", 15", 18", 21", or 24" HIGH

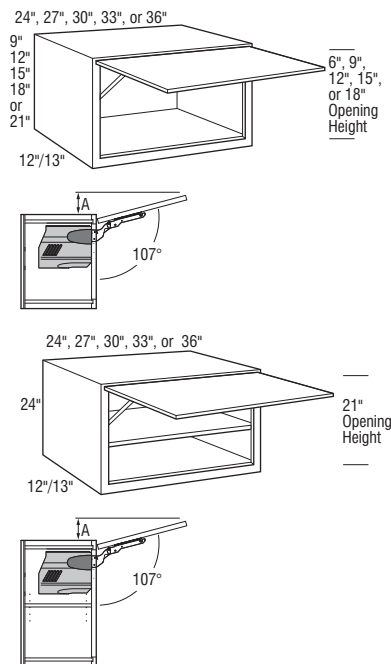

Cubic Feet	1	2	3	4	5	6	7	
NEW WTH2409SL	2.3	1739	1831	1891	1998	2127	2328	2529
NEW WTH2709SL	2.6	1780	1869	1934	2036	2173	2370	2567
NEW WTH3009SL	2.8	1820	1912	1974	2079	2212	2411	2610
NEW WTH3309SL	3.1	1859	1954	2013	2121	2250	2451	2652
NEW WTH3609SL	3.4	1899	1997	2053	2164	2289	2492	2695
NEW WTH2412SL	2.9	1819	1914	1980	2091	2223	2435	2647
NEW WTH2712SL	3.3	1860	1953	2022	2130	2267	2476	2685
NEW WTH3012SL	3.6	1900	1995	2062	2172	2307	2517	2727
NEW WTH3312SL	4.0	1940	2037	2102	2214	2346	2557	2768
NEW WTH3612SL	4.3	1980	2079	2142	2256	2386	2598	2810
WTH2415SL	3.5	1899	1997	2069	2184	2319	2542	2765
WTH2715SL	3.9	1940	2037	2110	2224	2361	2582	2803
WTH3015SL	4.4	2009	2106	2180	2297	2432	2658	2884
WTH3315SL	4.8	2021	2120	2191	2307	2442	2663	2884
WTH3615SL	5.2	2090	2191	2271	2391	2534	2767	3000
WTH2418SL	4.2	1979	2080	2158	2277	2415	2649	2883
WTH2718SL	4.7	2020	2121	2198	2318	2455	2688	2921
WTH3018SL	5.2	2089	2190	2270	2389	2530	2765	3000
WTH3318SL	5.6	2102	2203	2280	2400	2538	2769	3000
WTH3618SL	6.1	2184	2287	2371	2500	2649	2890	3131
WTH2421SL	4.8	2061	2160	2235	2347	2482	2711	2940
WTH2721SL	5.4	2102	2202	2276	2387	2523	2752	2981
WTH3021SL	5.9	2142	2241	2316	2428	2564	2791	3018
WTH3321SL	6.5	2184	2282	2358	2470	2607	2832	3057
WTH3621SL	7.1	2224	2324	2399	2511	2646	2874	3102
WTH2424SL	5.5	2142	2241	2316	2428	2564	2791	3018
WTH2724SL	6.1	2184	2282	2358	2470	2607	2832	3057
WTH3024SL	6.7	2224	2324	2399	2511	2646	2874	3102
WTH3324SL	7.4	2265	2364	2439	2551	2687	2914	3141
WTH3624SL	8.0	2307	2406	2480	2591	2727	2956	3185

• One adjustable shelf.

Notes below apply to all products in section above:

- 9" high will be slab with Inset styles.
- Heavy duty Stay Lift mechanism.
- Mechanism is not sold separately.
- Grain on center panels and slab doors will run horizontally and door rail configuration on non-miter doors will be unique from adjacent cabinet doors.
- Increased Depths available in 1/4" increments from 12 1/4" to 30".
- Door opens to 107°. Angle restriction clips available, see page S•16.
- Additional accessories available for Automatic Opening Mechanism option, refer to page S•13.

Cabinet Height	A Dimension					
	9"	12"	15"	18"	21"	24"
Full Overlay	2 5/8"	3 3/8"	3 11/16"	4 1/2"	5 3/8"	6 1/4"

Door & Drawer Options

AF	AOMD ¹	CC	CG	GAMD	HC	IFHG	MC	MD	MFO	PRMD	SHMD	SPLITDR	SPLITDRWS	TCG	TCP
✓	✓	✓	✓	✓	✓	✓	✓	✓	✓	✓	✓	✓	✓	✓	✓

End Panel Options

AUTH	CSFPE	EXBK	EXDN	FFD	FL/FR	FPE	INTGE	IPE
✓	✓	✓	✓	✓	✓	✓	✓	✓

Custom Modification Options

ADD_SHLF	ADDTK	ADRW	BVR	CBO	CCO	CFNTO	CFRMO	CLIP	CND	CSDGBK	EX	EX_OL	FALL	FBFL	FLUT ²	FTK	ID	IH ³
✓	✓	✓	✓	✓	✓	✓	✓	✓	✓	✓	✓	✓	✓	✓	✓	✓	✓	✓

INVRM	IW ⁴	LIGHT	MIP	OBRB	PFINBTMB	RD	RECTK	RH ⁵	ROSFLUT	RT	RW	STW	TD	TKP	TVR	WS ⁶	WTR
✓	✓	✓	✓	✓	✓	✓	✓	✓	✓	✓	✓	✓	✓	✓	✓	✓	✓

¹ Not available on 9" or 12" high.

² Not available with 6" fluting.

³ Not available on 9", 12", or 24" high.

⁴ Not available on 36" wide.

⁵ Only available on 12" and 15" high.

⁶ Not available on WSR1.5 and WSL1.5.

Wall Cabinets

WALL, 24" or 27" HIGH

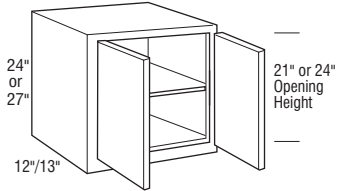
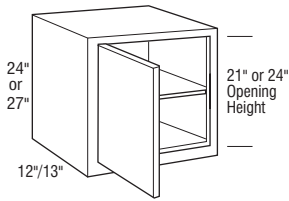

	Cubic Feet	1	2	3	4	5	6	7
W924 L or R	2.2	694	729	753	797	846	921	996
W1224 L or R	2.9	732	769	793	840	880	966	1052
W1524 L or R	3.5	768	801	828	876	915	1005	1095
W1824 L or R	4.2	811	854	878	928	987	1076	1165
W2124 L or R	4.8	828	871	904	952	1000	1097	1194
W2424 L or R	5.5	872	914	950	999	1060	1153	1246
W927 L or R	2.5	723	759	777	822	880	963	1046
W1227 L or R	3.2	769	805	837	881	936	1021	1106
W1527 L or R	3.9	811	854	884	935	980	1075	1170
W1827 L or R	4.7	850	893	929	977	1042	1126	1210
W2127 L or R	5.4	880	921	955	1005	1060	1161	1262
W2427 L or R	6.1	910	963	993	1048	1107	1207	1307

W2424	5.5	1122	1179	1207	1279	1357	1485	1613
W2724	6.1	1233	1293	1341	1416	1497	1631	1765
W3024	6.7	1284	1346	1396	1466	1556	1701	1846
W3324	7.4	1320	1385	1436	1516	1581	1728	1875
W3424	7.2	1353	1419	1471	1550	1627	1781	1935
W3624	8.0	1385	1453	1506	1583	1672	1834	1996
W3724	7.8	1409	1478	1527	1608	1698	1858	2018
W3924	8.7	1433	1503	1548	1632	1723	1882	2041
W2427	6.1	1179	1238	1279	1347	1438	1566	1694
W2727	6.8	1303	1368	1417	1497	1565	1712	1859
W3027	7.5	1335	1400	1453	1532	1624	1773	1922
W3327	8.3	1369	1439	1497	1576	1651	1802	1953
W3427	8.1	1406	1478	1532	1615	1699	1851	2003
W3627	9.0	1442	1516	1566	1653	1746	1899	2052
W3727	8.8	1471	1542	1595	1682	1781	1939	2097
W3927	9.7	1500	1568	1624	1711	1815	1979	2143

Notes below apply to all products in section above:

- One adjustable shelf.
- Inset and Beaded Inset Door Styles are a standard 13" deep.
- Full Overlay Styles:
 - Increased Depths available in 1/4" increments from 12 1/4" to 30".
 - Reduced Depths available in 1/4" increments from 6" to 11 3/4".
- Inset and Beaded Inset Styles:
 - Increased Depths available in 1/4" increments from 13 1/4" to 30".
 - Reduced Depths available in 1/4" increments from 6" to 12 3/4".

Door & Drawer Options

AF	AQMD	CC ¹	CG	GAMD ¹	HC	IFHG	MC	MD ¹	MFO	PRMD ²	SHMD ¹	SPLITDR ³	SPLITDRWS	TCG	TCP
✓	✓	✓	✓	✓	✓	✓	✓	✓	✓	✓	✓	✓	✓	✓	✓

End Panel Options

AUTH	CSFPE	EXBK	EXDN	FFD	FL/FR	FPE	INTGE	IPE
✓	✓	✓	✓	✓	✓	✓	✓	✓

Custom Modification Options

ADD	SHLF	ADTK	ADRW	BVR	CBO	CCO	CFNTO	CFRMO	CLIP ⁴	CND	CSDGBK	EX	EX_OL	FALL	FBFL	FLUT ⁵	FTK ⁶	ID	IH	
✓	✓	✓	✓	✓	✓	✓	✓	✓	✓	✓	✓	✓	✓	✓	✓	✓	✓	✓	✓	✓

INVERM	IW ⁷	LIGHT	MIP	OBRB	PFINBTMB	RD	RECTK	RH	ROSFLUT	RT ⁸	RW	STW	TD	TKP	TVR ⁹	WS	WTR
✓	✓	✓	✓	✓	✓	✓	✓	✓	✓	✓	✓	✓	✓	✓	✓	✓	✓

- ¹ Not available on 9" wide.
- ² Not available on 9", 12" or 24" (2 doors) wide.
- ³ Only available on 24" (2 doors)-39" wide.
- ⁴ Not available on 9", 12" or 24" (2 doors) wide.
- ⁵ Not available with 6" fluting.
- ⁶ FTKAV and style B-L not available on 9" or 12" wide.
- ⁷ Not available on 24" (1 door) wide.
- ⁸ Not available on 9" or 39" wide.
- ⁹ Not available on 42"-48" wide and TVRAV and style B-L not available on 9" or 12" wide.

IH/RH availability charts starting on page G•40.
IW/RW availability charts starting on page G•46.

WALL, 24" or 27" HIGH (cont'd)

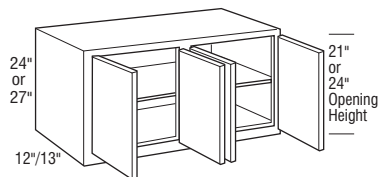
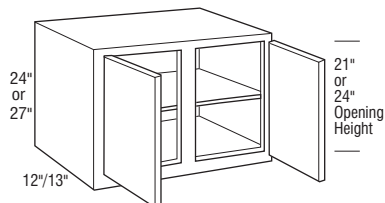

Cubic Feet	1	2	3	4	5	6	7
W4224	9.3	1474	1548	1603	1690	1779	2111
W4524	9.9	1556	1631	1690	1780	1881	2231
W4824CS	10.6	1631	1711	1771	1866	1961	2317
W4227	10.4	1592	1666	1728	1826	1924	2294
W4527	11.1	1630	1707	1769	1862	1963	2327
W4827CS	11.8	1770	1854	1915	2019	2131	2529

W4824	10.6	1810	1899	1966	2071	2177	2374	2571
W4827	11.8	1965	2058	2126	2241	2365	2586	2807

- One adjustable shelf.
- Inset and Beaded Inset Door Styles are a standard 13" deep.
- Full Overlay Styles:
 - Increased Depths available in 1/4" increments from 12 1/4" to 30".
 - Reduced Depths available in 1/4" increments from 6" to 11 3/4".
- Inset and Beaded Inset Styles:
 - Increased Depths available in 1/4" increments from 13 1/4" to 30".
 - Reduced Depths available in 1/4" increments from 6" to 12 3/4".

Door & Drawer Options

AF	AOMD	CC	CG	GAMD	HC	IFHG	MC	MD	MFO	PRMD	SHMD	SPLITDR	SPLITDRWS	TCG	TCP
✓		✓	✓	✓	✓	✓	✓	✓	✓	✓	✓				

End Panel Options

AUTH	CSFPE	EXBK	EXDN	FFD	FL/FR	FPE	INTGE	IPE
✓	✓	✓	✓	✓	✓	✓	✓	✓

Custom Modification Options

ADD_SHLF	ADDTK	ADRW	BVR	CBO	CCO	CFNTO	CFRMO	CLIP	CND	CSDGBK	EX	EX_OL	FALL	FBFL	FLUT ¹	FTK	ID	IH
✓		✓	✓	✓	✓	✓	✓	✓	✓	✓	✓	✓	✓	✓	✓	✓	✓	✓
INVERM	IW ²	LIGHT	MIP	OBRB	PFINBTMB	RD	RECTK	RH	ROSLUT	RT	RW	STW	TD	TKP	TVR	WS	WTR	
✓	✓	✓	✓	✓	✓	✓			✓	✓			✓			✓	✓	

¹ Not available with 6" fluting.

² Not available on 48" wide.

Wall Cabinets

WALL, 30" or 33" HIGH

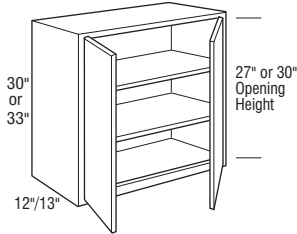
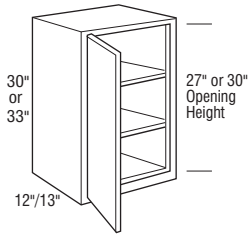

	Cubic Feet	1	2	3	4	5	6	7
W930 L or R	2.8	739	775	796	841	902	978	1054
W1230 L or R	3.6	784	817	854	903	953	1043	1133
W1530 L or R	4.4	828	871	904	952	1000	1097	1194
W1830 L or R	5.2	869	909	946	996	1055	1143	1231
W2130 L or R	5.9	902	939	971	1020	1076	1177	1278
W2430 L or R	6.7	930	978	1010	1067	1122	1224	1326
W933 L or R	3.0	884	930	953	1011	1076	1174	1272
W1233 L or R	3.9	939	980	1021	1078	1143	1249	1355
W1533 L or R	4.8	994	1046	1080	1142	1198	1311	1424
W1833 L or R	5.6	1043	1089	1132	1196	1266	1370	1474
W2133 L or R	6.5	1076	1128	1165	1226	1293	1410	1527
W2433 L or R	7.4	1115	1174	1207	1278	1347	1468	1589
W2430	6.7	1198	1255	1297	1363	1455	1582	1709
W2730	7.5	1320	1385	1436	1516	1581	1728	1875
W3030	8.3	1385	1453	1506	1583	1672	1834	1996
W3330	9.1	1433	1503	1548	1632	1723	1882	2041
W3630	9.9	1481	1557	1613	1707	1789	1952	2115
W3930	10.7	1557	1632	1699	1785	1882	2059	2236
W2433	7.4	1438	1505	1556	1636	1744	1897	2050
W2733	8.3	1582	1660	1721	1818	1896	2074	2252
W3033	9.1	1660	1742	1808	1901	2004	2203	2402
W3333	10.0	1717	1805	1858	1958	2067	2257	2447
W3633	10.9	1779	1869	1936	2047	2149	2340	2531
W3933	11.7	1869	1958	2035	2139	2257	2470	2683

Notes below apply to all products in section above:

- Two adjustable shelves.
- Inset and Beaded Inset Door Styles are a standard 13" deep.
- Full Overlay Styles:
 - Increased Depths available in 1/4" increments from 12 1/4" to 30".
 - Reduced Depths available in 1/4" increments from 6" to 11 3/4".
- Inset and Beaded Inset Styles:
 - Increased Depths available in 1/4" increments from 13 1/4" to 30".
 - Reduced Depths available in 1/4" increments from 6" to 12 3/4".

Door & Drawer Options

AF	AOMD	CC ¹	CG	GAMD ¹	HC ¹	IFHG	MC ¹	MD ¹	MFO	PRMD ²	SHMD ¹	SPLITDR ³	SPLITDRWS	TCG	TCP
✓	✓	✓	✓	✓	✓	✓	✓	✓	✓	✓	✓	✓	✓	✓	✓

End Panel Options

AUTH	CSFPE	EXBK	EXDN	FFD	FL/FR	FPE	INTGE	IPE
✓	✓	✓	✓	✓	✓	✓	✓	✓

Custom Modification Options

ADD_SHLF	ADDTK	ADRW	BVR	CBO	CCO	CFNTO	CFRMO	CLIP ⁴	CND	CSDGBK	EX	EX_OL	FALL	FBFL	FLUT ⁵	FTK ⁶	ID	IH
✓	✓	✓	✓	✓	✓	✓	✓	✓	✓	✓	✓	✓	✓	✓	✓	✓	✓	✓

INVFRM	IW ⁷	LIGHT	MIP	OBRB	PFINBTMB	RD	RECTK	RH	ROSFLUT	RT ⁸	RW	STW	TD	TKP	TVR ⁹	WS	WTR
✓	✓	✓	✓	✓	✓	✓	✓	✓	✓	✓	✓	✓	✓	✓	✓	✓	✓

- ¹ Not available on 9" wide.
- ² Not available on 9", 12" or 24" (2 doors) wide.
- ³ Only available on 24" (2 doors)-39" wide.
- ⁴ Not available on 9", 12" or 24" (2 doors) wide.
- ⁵ Not available with 6" fluting.
- ⁶ FTKAV and style B-L not available on 9" or 12" wide.
- ⁷ Not available on 24" (1 door) wide.
- ⁸ Not available on 9" or 39" wide.
- ⁹ Not available on 42"-48" wide and TVRAV and style B-L not available on 9" or 12" wide.

IH/RH availability charts starting on page G•40.
IW/RW availability charts starting on page G•46.

WALL, 30" or 33" HIGH (cont'd)

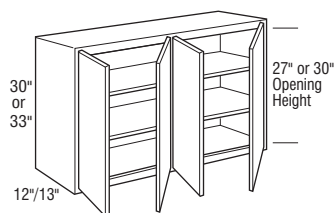
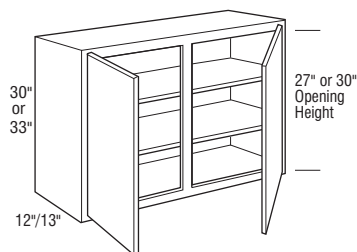

	Cubic Feet	1	2	3	4	5	6	7
W4230	11.5	1609	1682	1746	1846	1945	2126	2307
W4530	12.3	1703	1780	1842	1945	2046	2236	2426
W4830CS	13.1	1785	1870	1930	2037	2150	2350	2550
W4233	12.6	1929	2020	2096	2212	2330	2549	2768
W4533	13.5	2043	2136	2208	2330	2454	2681	2908
W4833CS	14.3	2139	2243	2318	2441	2577	2817	3057
W4830	13.1	2035	2132	2200	2322	2451	2679	2907
W4833	14.3	2460	2579	2666	2807	2964	3240	3516

- Two adjustable shelves.
- Inset and Beaded Inset Door Styles are a standard 13" deep.
- Full Overlay Styles:
 - Increased Depths available in 1/4" increments from 12 1/4" to 30".
 - Reduced Depths available in 1/4" increments from 6" to 11 3/4".
- Inset and Beaded Inset Styles:
 - Increased Depths available in 1/4" increments from 13 1/4" to 30".
 - Reduced Depths available in 1/4" increments from 6" to 12 3/4".

Door & Drawer Options

AF	AOMD	CC	CG	GAMD	HC	IFHG	MC	MD	MFO	PRMD	SHMD	SPLITDR	SPLITDRWS	TCG	TCP
✓		✓	✓	✓	✓	✓	✓	✓	✓	✓	✓				

End Panel Options

AUTH	CSFPE	EXBK	EXDN	FFD	FL/FR	FPE	INTGE	IPE
✓	✓	✓	✓	✓	✓	✓	✓	✓

Custom Modification Options

ADD_SHLF	ADDTK	ADRW	BVR	CBO	CCO	CFNTO	CFRMO	CLIP	CND	CSDGBK	EX	EX_OL	FALL	FBFL	FLUT ¹	FTK	ID	IH
✓			✓					✓	✓	✓	✓	✓	✓	✓	✓	✓	✓	✓

INVERM	IW ²	LIGHT	MIP	OBRB	PFINBTMB	RD	RECTK	RH	ROSLUT	RT	RW	STW	TD	TKP	TVR	WS	WTR
	✓	✓	✓	✓	✓	✓			✓	✓			✓			✓	✓

- ¹ Not available with 6" fluting.
² Not available on 48" wide.

WALL EASY ACCESS STORAGE CABINET, 30" HIGH L G I X

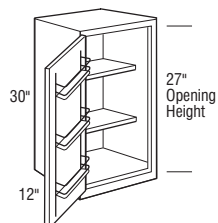

WEAS1530 L or R	4.4	1080	1127	1160	1206	1255	1350	1445
WEAS1830 L or R	5.2	1122	1165	1201	1252	1311	1399	1487
WEAS3030	8.3	1838	1908	1961	2045	2129	2292	2455
WEAS3630	9.9	1888	1958	2004	2089	2184	2336	2488

Notes below apply to all products in section above:

- Adjustable shelves are 7 1/4" deep.
- Racks on doors are 3 1/4" deep.
- Reduced Depths available in 1/4" increments from 9" to 11 3/4".
- Increased Depths available in 1/4" increments from 12 1/4" to 30".
- Not available on Inset and Beaded Inset styles.

Door & Drawer Options

AF	AOMD	CC	CG	GAMD	HC	IFHG	MC	MD	MFO	PRMD	SHMD	SPLITDR	SPLITDRWS	TCG	TCP
										✓					

End Panel Options

AUTH	CSFPE	EXBK	EXDN	FFD	FL/FR	FPE	INTGE	IPE
✓	✓	✓	✓	✓	✓	✓	✓	✓

Custom Modification Options

ADD_SHLF	ADDTK	ADRW	BVR	CBO	CCO	CFNTO	CFRMO	CLIP ¹	CND	CSDGBK	EX	EX_OL	FALL	FBFL	FLUT ²	FTK	ID	IH
✓			✓					✓	✓	✓	✓	✓	✓	✓	✓	✓	✓	✓

INVERM	IW	LIGHT	MIP	OBRB	PFINBTMB	RD	RECTK	RH	ROSLUT	RT	RW	STW	TD	TKP	TVR	WS	WTR
		✓	✓	✓	✓	✓			✓	✓			✓			✓	✓

- ¹ Not available on 15" wide.
² Not available with 6" fluting.

Wall Cabinets

WALL, 36" HIGH

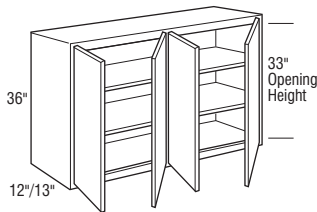
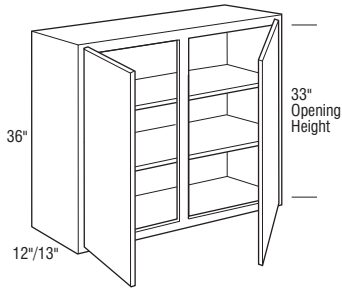
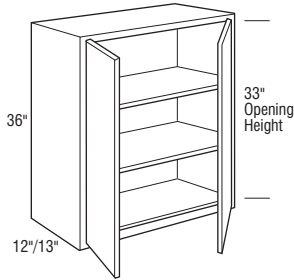
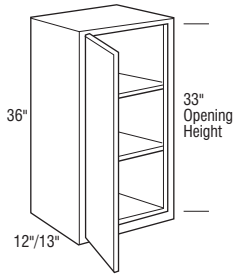

	Cubic Feet	1	2	3	4	5	6	7
W936 L or R	3.3	962	1005	1039	1097	1167	1278	1389
W1236 L or R	4.2	1037	1083	1119	1188	1249	1367	1485
W1536 L or R	5.2	1080	1139	1187	1244	1313	1433	1553
W1836 L or R	6.1	1133	1192	1230	1299	1367	1491	1615
W2136 L or R	7.1	1181	1236	1281	1347	1417	1546	1675
W2436 L or R	8.0	1217	1278	1322	1396	1464	1597	1730
W2436	8.0	1524	1598	1646	1737	1848	2015	2182
W2736	9.0	1742	1823	1890	1990	2097	2291	2485
W3036	9.9	1815	1901	1973	2075	2195	2398	2601
W3336	10.9	1871	1966	2033	2142	2268	2476	2684
W3636	11.8	1949	2046	2122	2238	2352	2575	2798
W3936	12.7	2021	2122	2197	2318	2452	2676	2900
W4236	13.7	2090	2191	2266	2394	2517	2753	2989
W4536	14.6	2206	2314	2396	2528	2656	2903	3150
W4836CS	15.6	2314	2423	2511	2645	2785	3039	3293
W4836	15.6	2661	2786	2888	3042	3203	3495	3787

Notes below apply to all products in section above:

- Two adjustable shelves.
- Inset and Beaded Inset Door Styles are a standard 13" deep.
- Full Overlay Styles:
 - Increased Depths available in 1/4" increments from 12 1/4" to 30".
 - Reduced Depths available in 1/4" increments from 6" to 11 3/4".
- Inset and Beaded Inset Styles:
 - Increased Depths available in 1/4" increments from 13 1/4" to 30".
 - Reduced Depths available in 1/4" increments from 6" to 12 3/4".

Door & Drawer Options

AF	AOMD	CC ¹	CG	GAMD ¹	HC	IFHG	MC	MD ¹	MFO	PRMD ²	SHMD ¹	SPLITDR ³	SPLITDRWS	TCG	TCP
✓	✓	✓	✓	✓	✓	✓	✓	✓	✓	✓	✓	✓	✓	✓	✓

End Panel Options

AUTH	CSFPE	EXBK	EXDN	FFD	FL/FR	FPE	INTGE	IPE
✓	✓	✓	✓	✓	✓	✓	✓	✓

Custom Modification Options

ADD	SHLF	ADDTK	ADRW	BVR	CBO	CCO	CFNTO	CFRMO	CLIP ⁴	CND	CSDGBK	EX	EX_OL	FALL	FBFL	FLUT ⁵	FTK ⁶	ID	IH
✓	✓	✓	✓	✓	✓	✓	✓	✓	✓	✓	✓	✓	✓	✓	✓	✓	✓	✓	✓

INVERM	IW ⁷	LIGHT	MIP	OBRB	PFINBTMB	RD	RECTK	RH	ROSFLUT	RT ⁸	RW	STW	TD ⁹	TKP	TVR ¹⁰	WS	WTR
✓	✓	✓	✓	✓	✓	✓	✓	✓	✓	✓	✓	✓	✓	✓	✓	✓	✓

- ¹ Not available on 9" wide.
- ² Not available on 9", 12" or 24" (2 doors) wide.
- ³ Only available on 24" (2 doors)-39" wide.
- ⁴ Not available on 9", 12" or 24" (2 doors) wide.
- ⁵ Not available with 6" fluting.
- ⁶ FTKAV and style B-L not available on 9" or 12" wide.
- ⁷ Not available on 24" (1 door) or 48" wide.
- ⁸ Not available on 9" or 39" wide.
- ⁹ Not available on 9" or 24" (2 doors) wide.
- ¹⁰ Not available on 42"-48" wide and TVRAV and style B-L not available on 9" or 12" wide.

IH/RH availability charts starting on page G-40.
IW/RW availability charts starting on page G-46.

WALL TOP HINGE with BIFOLD, 30", 33", or 36" HIGH

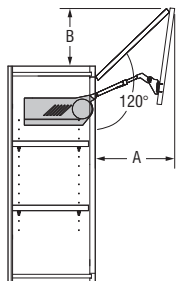
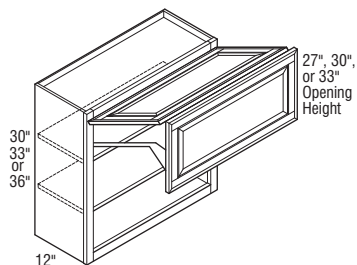

	Cubic Feet	1	2	3	4	5	6	7
WTH2430BF	6.7	2478	2576	2649	2762	2897	3120	3343
WTH2730BF	7.5	2518	2617	2689	2778	2913	3134	3355
WTH3030BF	8.3	2559	2657	2727	2816	2952	3173	3394
WTH3330BF	9.1	2599	2697	2767	2855	2991	3213	3435
WTH3630BF	9.9	2641	2738	2808	2895	3031	3254	3477
WTH2433BF	7.4	2558	2658	2735	2856	2993	3226	3459
WTH2733BF	8.3	2598	2699	2778	2896	3034	3267	3500
WTH3033BF	9.1	2640	2741	2818	2936	3075	3308	3541
WTH3333BF	10.0	2681	2781	2859	2978	3116	3349	3582
WTH3633BF	10.9	2721	2822	2898	3020	3157	3389	3621
WTH2436BF	8.0	2721	2821	2895	3008	3143	3371	3599
WTH2736BF	9.0	2762	2861	2935	3047	3184	3413	3642
WTH3036BF	9.9	2802	2902	2977	3088	3224	3452	3680
WTH3336BF	10.9	2843	2943	3018	3130	3266	3492	3718
WTH3636BF	11.8	2885	2983	3059	3170	3307	3533	3759

- Not available on Inset and Beaded Inset styles.
- Grain on center panels and slab doors will run horizontally and door rail configuration on non-miter doors will be unique from adjacent cabinet doors.
- Door opens to 120°. Angle restriction clips available; see page S•16.
- Additional accessories available for Automatic Opening Mechanism option, refer to page S•13.

	Cabinet Height	A	B
Full Overlay	30"	14 3/8"	7 3/8"
	33"	15 3/4"	8 1/16"
	36"	17 1/16"	8 3/4"

Door & Drawer Options

AF	AOMD	CC	CG	GAMD	HC	IFHG	MC	MD	MFO	PRMD	SHMD	SPLITDR	SPLITDRWS	TCG	TCP
✓	✓	✓	✓										✓		

End Panel Options

AUTH	CSFPE	EXBK	EXDN	FFD	FL/FR	FPE	INTGE	IPE
✓	✓	✓	✓	✓	✓	✓	✓	✓

Custom Modification Options

ADD_SHLF	ADDTK	ADRW	BVR	CBO	CCO	CFNTD	CFRMO	CLIP	CND	CSDGBK	EX	EX_OL	FALL	FBFL	FLUT ¹	FTK	ID	IH ²
	✓	✓						✓		✓	✓	✓	✓	✓	✓	✓	✓	✓
INVFRM	IW ³	LIGHT	MIP	OBRB	PFINBTMB	RD	RECTK	RH	ROSEFLUT	RT	RW	STW	TD	TKP	TVR	WS	WTR	
✓	✓	✓	✓	✓	✓	✓			✓							✓	✓	

¹ Not available with 6" fluting.
² Not available on 36" high.
³ Not available on 36" wide.

Wall Cabinets

WALL, 39" or 42" HIGH

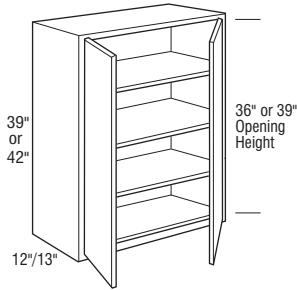
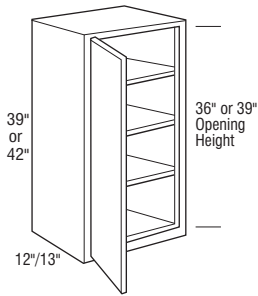

	Cubic Feet	1	2	3	4	5	6	7
W939 L or R	3.6	1026	1074	1111	1170	1251	1367	1483
W1239 L or R	4.6	1110	1163	1199	1268	1337	1463	1589
W1539 L or R	5.6	1161	1217	1266	1331	1405	1532	1659
W1839 L or R	6.6	1213	1276	1316	1390	1463	1597	1731
W2139 L or R	7.6	1263	1322	1369	1441	1519	1655	1791
W2439 L or R	8.7	1302	1367	1415	1492	1566	1707	1848
W942 L or R	3.8	1110	1160	1201	1266	1331	1457	1583
W1242 L or R	4.9	1160	1218	1258	1331	1409	1543	1677
W1542 L or R	6.0	1217	1278	1322	1396	1464	1599	1734
W1842 L or R	7.1	1268	1332	1385	1457	1546	1679	1812
W2142 L or R	8.2	1327	1393	1439	1522	1599	1744	1889
W2442 L or R	9.3	1363	1432	1473	1557	1646	1794	1942

W2439	8.7	1630	1710	1760	1860	1977	2158	2339
W2739	9.7	1866	1951	2026	2132	2245	2453	2661
W3039	10.7	1944	2037	2109	2222	2351	2567	2783
W3339	11.7	2001	2102	2175	2296	2422	2651	2880
W3639	12.7	2086	2188	2271	2389	2517	2756	2995
W3939	13.8	2161	2271	2357	2479	2620	2861	3102
W2442	9.3	1671	1754	1810	1908	2027	2211	2395
W2742	10.4	1958	2056	2128	2240	2361	2576	2791
W3042	11.5	2033	2131	2208	2329	2453	2676	2899
W3342	12.6	2097	2197	2276	2406	2548	2785	3022
W3642	13.7	2187	2292	2369	2506	2644	2891	3138
W3942	14.8	2254	2369	2453	2582	2727	2981	3235

Notes below apply to all products in section above:

- Three adjustable shelves.
- Inset and Beaded Inset Door Styles are a standard 13" deep.
- Full Overlay Styles:
 - Increased Depths available in 1/4" increments from 12 1/4" to 30".
 - Reduced Depths available in 1/4" increments from 6" to 11 3/4".
- Inset and Beaded Inset Styles:
 - Increased Depths available in 1/4" increments from 13 1/4" to 30".
 - Reduced Depths available in 1/4" increments from 6" to 12 3/4".

Door & Drawer Options

AF	AOMD	CC ¹	CG	GAMD ¹	HC	IFHG	MC	MD ¹	MFO	PRMD ²	SHMD ¹	SPLITDR ³	SPLITDRWS	TCG	TCP
✓	✓	✓	✓	✓	✓	✓	✓	✓	✓	✓	✓	✓	✓	✓	✓

End Panel Options

AUTH	CSFPE	EXBK	EXDN	FFD	FL/FR	FPE	INTGE	IPE
✓	✓	✓	✓	✓	✓	✓	✓	✓

Custom Modification Options

ADD	SHLF	ADTK	ADRW	BVR	CBO	CCO	CFNTO	CFRMO	CLIP ⁴	CND	CSDGBK	EX	EX_OL	FALL	FBFL	FLUT ⁵	FTK ⁶	ID	IH
✓	✓	✓	✓	✓	✓	✓	✓	✓	✓	✓	✓	✓	✓	✓	✓	✓	✓	✓	✓

INVFRM	IW ⁷	LIGHT	MIP	OBRB	PFINBTMB	RD	RECTK	RH	ROSFLUT	RT ⁸	RW	STW	TD ⁹	TKP	TVR ¹⁰	WS	WTR
✓	✓	✓	✓	✓	✓	✓	✓	✓	✓	✓	✓	✓	✓	✓	✓	✓	✓

- ¹ Not available on 9" wide.
- ² Not available on 9", 12", or 24" (2 doors) wide.
- ³ Only available on 24" (2 doors)-39" wide.
- ⁴ Not available on 9", 12" or 24" (2 doors) wide.
- ⁵ Not available with 6" fluting.
- ⁶ FTKAV and style B-L not available on 9" or 12" wide.
- ⁷ Not available on 24" (1 door) wide.
- ⁸ Not available on 9" or 39" wide.
- ⁹ Not available on 9" or 24" (2 doors) wide.
- ¹⁰ Not available on 42"-48" wide and TVRAV and style B-L not available on 9" or 12" wide.

IH/RH availability charts starting on page G-40.
IW/RW availability charts starting on page G-46.

WALL, 39" or 42" HIGH (cont'd)

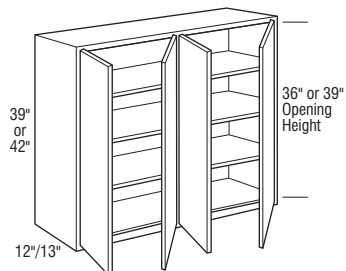
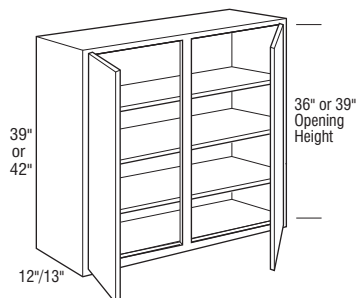

	Cubic Feet	1	2	3	4	5	6	7
W4239	14.8	2238	2341	2421	2561	2693	2946	3199
W4539	15.8	2361	2475	2566	2709	2843	3110	3377
W4839CS	16.8	2475	2594	2687	2829	2977	3250	3523
W4242	15.9	2329	2447	2534	2672	2808	3064	3320
W4542	17.0	2455	2572	2658	2805	2960	3234	3508
W4842CS	18.1	2572	2699	2796	2948	3100	3385	3670
W4839	16.8	2846	2983	3090	3253	3424	3738	4052
W4842	18.1	2958	3104	3215	3390	3565	3893	4221

- Three adjustable shelves.
- Inset and Beaded Inset Door Styles are a standard 13" deep.
- Full Overlay Styles:
 - Increased Depths available in 1/4" increments from 12 1/4" to 30".
 - Reduced Depths available in 1/4" increments from 6" to 11 3/4".
- Inset and Beaded Inset Styles:
 - Increased Depths available in 1/4" increments from 13 1/4" to 30".
 - Reduced Depths available in 1/4" increments from 6" to 12 3/4".

Door & Drawer Options

AF	AOMD	CC	CG	GAMD	HC	IFHG	MC	MD	MFO	PRMD	SHMD	SPLITDR	SPLITDRWS	TCG	TCP
✓		✓	✓	✓	✓	✓	✓	✓	✓	✓	✓			✓	✓

End Panel Options

AUTH	CSFPE	EXBK	EXDN	FFD	FL/FR	FPE	INTGE	IPE
✓	✓	✓	✓	✓	✓	✓	✓	✓

Custom Modification Options

ADD_SHLF	ADDTK	ADRW	BVR	CBO	CCO	CFNTO	CFRMO	CLIP	CND	CSDGBK	EX	EX_OL	FALL	FBFL	FLUT ¹	FTK	ID	IH
✓			✓	✓	✓	✓	✓	✓	✓	✓	✓	✓	✓	✓	✓	✓	✓	✓

INVERM	IW ²	LIGHT	MIP	OBRB	PFINBTMB	RD	RECTK	RH	ROSFLUT	RT	RW	STW	TD	TKP	TVR	WS	WTR
	✓	✓	✓	✓	✓	✓			✓	✓			✓			✓	✓

¹ Not available with 6" fluting.

² Not available on 48" wide.

Wall Cabinets

WALL, 45" or 48" HIGH

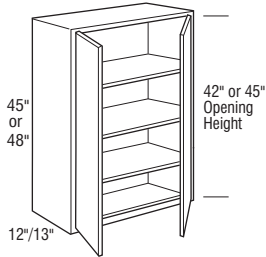
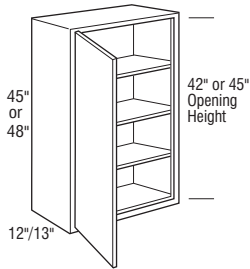

	Cubic Feet	1	2	3	4	5	6	7
W945 L or R	4.1	1441	1505	1561	1646	1728	1892	2056
W1245 L or R	5.3	1505	1582	1636	1728	1834	2004	2174
W1545 L or R	6.4	1581	1660	1720	1811	1899	2075	2251
W1845 L or R	7.6	1650	1731	1800	1892	2009	2185	2361
W2145 L or R	8.8	1723	1808	1870	1979	2075	2270	2465
W2445 L or R	9.9	1773	1859	1917	2026	2137	2329	2521
W948 L or R	4.4	1626	1706	1757	1834	1917	2095	2273
W1248 L or R	5.6	1712	1795	1851	1930	2015	2206	2397
W1548 L or R	6.9	1794	1876	1935	2021	2116	2309	2502
W1848 L or R	8.1	1869	1956	2009	2107	2197	2406	2615
W2148 L or R	9.3	1946	2040	2096	2192	2303	2512	2721
W2448 L or R	10.6	2010	2109	2169	2266	2374	2593	2812
W2445	9.9	2170	2277	2357	2480	2630	2874	3118
W2745	11.1	2548	2668	2765	2911	3064	3351	3638
W3045	12.3	2644	2769	2866	3030	3184	3478	3772
W3345	13.5	2726	2858	2961	3126	3312	3618	3924
W3645	14.6	2843	2979	3078	3250	3435	3758	4081
W3945	15.8	2928	3078	3184	3358	3548	3876	4204
W2448	10.6	2315	2430	2487	2615	2722	2979	3236
W2748	11.8	2876	3018	3110	3244	3387	3709	4031
W3048	13.1	2995	3142	3230	3379	3520	3847	4174
W3348	14.3	3093	3239	3335	3494	3650	3985	4320
W3648	15.6	3213	3371	3459	3622	3801	4158	4515
W3948	16.8	3321	3478	3582	3751	3970	4338	4706

Notes below apply to all products in section above:

- Three adjustable shelves.
- Inset and Beaded Inset Door Styles are a standard 13" deep.
- Full Overlay Styles:
 - Increased Depths available in 1/4" increments from 12 1/4" to 30".
 - Reduced Depths available in 1/4" increments from 6" to 11 3/4".
- Inset and Beaded Inset Styles:
 - Increased Depths available in 1/4" increments from 13 1/4" to 30".
 - Reduced Depths available in 1/4" increments from 6" to 12 3/4".

Door & Drawer Options

AF	AOMD	CC ¹	CG	GAMD ¹	HC	IFHG	MC	MD ¹	MFO	PRMD ²	SHMD ¹	SPLITDR ³	SPLITDRWS	TCG	TCP
✓	✓	✓	✓	✓	✓	✓	✓	✓	✓	✓	✓	✓	✓	✓	✓

End Panel Options

AUTH	CSFPE	EXBK	EXDN	FFD	FL/FR	FPE	INTGE	IPE
✓	✓	✓	✓	✓	✓	✓	✓	✓

Custom Modification Options

ADD_SHLF	ADDTK	ADRW	BVR	CBO	CCO	CFNTO	CFRMO	CLIP ⁴	CND	CSDGBK	EX	EX_OL	FALL	FBFL	FLUT ⁵	FTK ⁶	ID	IH
✓	✓	✓	✓	✓	✓	✓	✓	✓	✓	✓	✓	✓	✓	✓	✓	✓	✓	✓

INVERM	IW ⁷	LIGHT	MIP	OBRB	PFINBTMB	RD	RECTK	RH	ROSFLUT	RT ⁸	RW	STW	TD	TKP	TVR ⁹	WS	WTR
✓	✓	✓	✓	✓	✓	✓	✓	✓	✓	✓	✓	✓	✓	✓	✓	✓	✓

- ¹ Not available on 9" wide.
- ² Not available on 9", 12", or 24" (2 doors) wide.
- ³ Only available on 24" (2 doors)-39" wide.
- ⁴ Not available on 9", 12" or 24" (2 doors) wide.
- ⁵ Not available with 6" fluting.
- ⁶ FTKAV and style B-L not available on 9" or 12" wide.
- ⁷ Not available on 24" (1 door) wide.
- ⁸ Not available on 9" or 39" wide.
- ⁹ Not available on 42"-48" wide and TVRAV and style B-L not available on 9" or 12" wide.

IH/RH availability charts starting on page G•40.
IW/RW availability charts starting on page G•46.

WALL, 45" or 48" HIGH (cont'd)

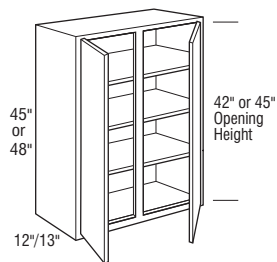

	Cubic Feet	1	2	3	4	5	6	7
W4245	17.0	3030	3178	3296	3474	3650	3983	4316
W4545	18.1	3187	3340	3457	3649	3842	4204	4566
W4845	19.3	3340	3502	3636	3833	4029	4403	4777
W4248	18.1	3428	3595	3695	3864	4051	4429	4807
W4548	19.3	3607	3778	3887	4068	4253	4643	5033
W4848	20.6	3770	3957	4076	4259	4466	4880	5294

- Three adjustable shelves.
- Inset and Beaded Inset Door Styles are a standard 13" deep.
- Full Overlay Styles:
 - Increased Depths available in 1/4" increments from 12 1/4" to 30".
 - Reduced Depths available in 1/4" increments from 6" to 11 3/4".
- Inset and Beaded Inset Styles:
 - Increased Depths available in 1/4" increments from 13 1/4" to 30".
 - Reduced Depths available in 1/4" increments from 6" to 12 3/4".

Door & Drawer Options

AF	AOMD	CC ¹	CG	GAMD ¹	HC	IFHG	MC	MD ¹	MFO	PRMD ²	SHMD ¹	SPLITDR ³	SPLITDRWS	TCG	TCP
✓	✓	✓	✓	✓	✓	✓	✓	✓	✓	✓	✓	✓	✓	✓	✓

End Panel Options

AUTH	CSFPE	EXBK	EXDN	FFD	FL/FR	FPE	INTGE	IPE
✓	✓	✓	✓	✓	✓	✓	✓	✓

Custom Modification Options

ADD_SHLF	ADDTK	ADRW	BVR	CBO	CCO	CFNTO	CFRMO	CLIP ⁴	CND	CSDGBK	EX	EX_OL	FALL	FBFL	FLUT ⁵	FTK ⁶	ID	IH
✓	✓	✓	✓	✓	✓	✓	✓	✓	✓	✓	✓	✓	✓	✓	✓	✓	✓	✓

INVFRM	IW ⁷	LIGHT	MIP	OBRB	PFINBTMB	RD	RECTK	RH	ROSFLUT	RT ⁸	RW	STW	TD	TKP	TVR ⁹	WS	WTR
✓	✓	✓	✓	✓	✓	✓	✓	✓	✓	✓	✓	✓	✓	✓	✓	✓	✓

- ¹ Not available on 9" wide.
² Not available on 9", 12", or 24" (2 doors) wide.
³ Only available on 24" (2 doors)-39" wide.
⁴ Not available on 9", 12" or 24" (2 doors) wide.
⁵ Not available with 6" fluting.
⁶ FTKAV and style B-L not available on 9" or 12" wide.
⁷ Not available on 48" wide.
⁸ Not available on 9" or 39" wide.
⁹ Not available on 42"-48" wide and TVRAV and style B-L not available on 9" or 12" wide.

Wall Cabinets

WALL with TWO DRAWERS, 48", 51", 54", 57", or 60" HIGH

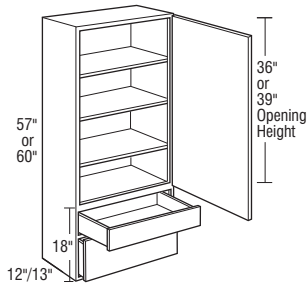
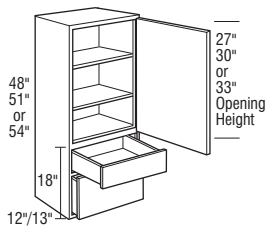

	Cubic Feet	1	2	3	4	5	6	7
W2D1548 L or R	6.9	1368	1411	1444	1492	1540	1637	1734
W2D1848 L or R	8.1	1409	1449	1486	1536	1595	1683	1771
W2D2448 L or R	10.6	1470	1518	1550	1607	1662	1764	1866
W2D1551 L or R	7.3	1534	1586	1620	1682	1738	1851	1964
W2D1851 L or R	8.6	1583	1629	1672	1736	1806	1910	2014
W2D2451 L or R	11.2	1655	1714	1747	1818	1887	2008	2129
W2D1554 L or R	7.7	1620	1679	1727	1784	1853	1973	2093
W2D1854 L or R	9.1	1673	1732	1770	1839	1907	2031	2155
W2D2454 L or R	11.9	1757	1818	1862	1936	2004	2137	2270
W2D1557 L or R	8.1	1701	1757	1806	1871	1945	2072	2199
W2D1857 L or R	9.6	1753	1816	1856	1930	2003	2137	2271
W2D2457 L or R	12.5	1842	1907	1955	2032	2106	2247	2388
W2D1560 L or R	8.5	1757	1818	1862	1936	2004	2139	2274
W2D1860 L or R	10.1	1808	1872	1925	1997	2086	2219	2352
W2D2460 L or R	13.2	1903	1972	2013	2097	2186	2334	2482

- 48"-54" high includes two adjustable shelves. 57"-60" high includes three adjustable shelves.
- Countertop backsplash must stop to set cabinet against wall.
- Inset and Beaded Inset Door Styles are a standard 13" deep.
- When Inset and Beaded Inset Door Styles are selected, the top drawer will be slab.
- Full Overlay Styles:
 - Increased Depths available in 1/4" increments from 12 1/4" to 30".
 - Reduced Depths available in 1/4" increments from 6" to 11 3/4".
- Inset and Beaded Inset Styles:
 - Increased Depths available in 1/4" increments from 13 1/4" to 30".
 - Reduced Depths available in 1/4" increments from 6" to 12 3/4".

Door & Drawer Options

AF	AOMD	CC	CG	GAMD	HC	IFHG	MC	MD	MFO	PRMD	SHMD	SPLITDR	SPLITDRWS	TCG ¹	TCP ¹
			✓			✓		✓	✓	✓				✓	✓

End Panel Options

AUTH	CSFPE	EXBK	EXDN	FFD	FL/FR	FPE	INTGE	IPE
✓	✓	✓	✓	✓	✓	✓	✓	✓

Custom Modification Options

ADD_SHLF	ADDTK	ADRW	BVR	CBO	CCO	CFNTO	CFRMO	CLIP	CND	CSDGBK	EX	EX_OL	F.ALL	FBFL	FLUT ²	FTK	ID ³	IH
	✓		✓	✓	✓	✓	✓	✓	✓	✓	✓	✓			✓	✓	✓	✓
INVERM	IW ⁴	LIGHT	MIP	OBRB	PFINBTMB	RD	RECTK	RH	ROSLUT	RT ⁴	RW	STW	TD ⁵	TKP	TVR	WS	WTR	
	✓		✓	✓	✓	✓	✓	✓	✓	✓	✓	✓	✓	✓	✓	✓	✓	

¹ Not available on 48" or 51" high.
² Not available with 6" fluting.
³ Not available on W2D2448 L or R and W2D2451 L or R.
⁴ Not available on 24" wide.
⁵ Only available on 48" high and W2D2454 L or R.

IH/RH availability charts starting on page G-40.
 IW/RW availability charts starting on page G-46.

WALL with TWO DRAWERS, 48", 51", 54", 57", or 60" HIGH

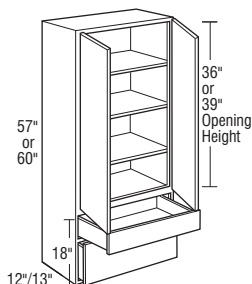
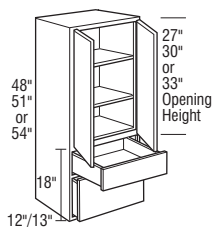

	Cubic Feet	1	2	3	4	5	6	7
W2D2448	10.6	1738	1795	1837	1903	1995	2122	2249
W2D2748	11.8	1860	1925	1976	2056	2121	2268	2415
W2D3048	13.1	1925	1993	2046	2123	2212	2374	2536
W2D3348	14.3	1973	2043	2088	2172	2263	2422	2581
W2D3648	15.6	2021	2097	2153	2247	2329	2492	2655
W2D2451	11.2	1978	2045	2096	2176	2284	2437	2590
W2D2751	12.6	2122	2200	2261	2358	2436	2614	2792
W2D3051	13.9	2200	2282	2348	2441	2544	2743	2942
W2D3351	15.2	2257	2345	2398	2498	2607	2797	2987
W2D3651	16.5	2319	2409	2476	2587	2689	2880	3071
W2D2454	11.9	2064	2138	2186	2277	2388	2555	2722
W2D2754	13.3	2282	2363	2430	2530	2637	2831	3025
W2D3054	14.7	2355	2441	2513	2615	2735	2938	3141
W2D3354	16.1	2411	2506	2573	2682	2808	3016	3224
W2D3654	17.5	2489	2586	2662	2778	2892	3115	3338
W2D2457	12.5	2170	2250	2300	2400	2517	2698	2879
W2D2757	14.0	2406	2491	2566	2672	2785	2993	3201
W2D3057	15.5	2484	2577	2649	2762	2891	3107	3323
W2D3357	16.9	2541	2642	2715	2836	2962	3191	3420
W2D3657	18.4	2626	2728	2811	2929	3057	3296	3535
W2D2460	13.2	2211	2294	2350	2448	2567	2751	2935
W2D2760	14.7	2498	2596	2668	2780	2901	3116	3331
W2D3060	16.3	2573	2671	2748	2869	2993	3216	3439
W2D3360	17.8	2637	2737	2816	2946	3088	3325	3562
W2D3660	19.4	2727	2832	2909	3046	3184	3431	3678

- 48"-54" high includes two adjustable shelves. 57"-60" high includes three adjustable shelves.
- Countertop backsplash must stop to set cabinet against wall.
- Inset and Beaded Inset Door Styles are a standard 13" deep.
- When Inset and Beaded Inset Door Styles are selected, the top drawer will be slab.
- Full Overlay Styles:
 - Increased Depths available in 1/4" increments from 12 1/4" to 30".
 - Reduced Depths available in 1/4" increments from 6" to 11 3/4".
- Inset and Beaded Inset Styles:
 - Increased Depths available in 1/4" increments from 13 1/4" to 30".
 - Reduced Depths available in 1/4" increments from 6" to 12 3/4".

Door & Drawer Options

AF	AOMD	CC	CG	GAMD	HC	IFHG	MC	MD	MFO	PRMD	SHMD	SPLITDR	SPLITDRWS	TCG ¹	TCP ¹

End Panel Options

AUTH	CSFPE	EXBK	EXDN	FFD	FL/FR	FPE	INTGE	IPE

Custom Modification Options

ADD	SHLF	ADDTK	ADRW	BVR	CBO	CCO	CFNTO	CFRMO	CLIP ²	CND	CSDGBK	EX	EX_OL	FALL	FBFL	FLUT ³	FTK	ID ⁴	IH
INVFRM	IW	LIGHT	MIP	OBRB	PFINBTMB	RD	RECTK	RH	ROSLUT	RT	RW	STW	TD ⁵	TKP	TVR	WS	WTR		

¹ Not available on 48" or 54" high.

² Not available on 24" wide.

³ Not available with 6" fluting.

⁴ Not available on W2D2451 and W2D2454.

⁵ Not available on 48" high.

Wall Cabinets

WALL with THREE DRAWERS, 48", 51", 54", 57", or 60" HIGH

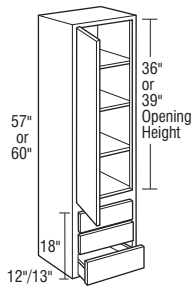
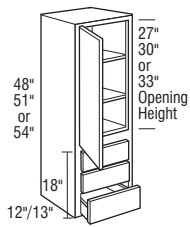

	Cubic Feet	1	2	3	4	5	6	7
W3D1548 L or R	6.9	1648	1691	1724	1772	1820	1917	2014
W3D1848 L or R	8.1	1689	1729	1766	1816	1875	1963	2051
W3D2448 L or R	10.6	1750	1798	1830	1887	1942	2044	2146
W3D1551 L or R	7.3	1814	1866	1900	1962	2018	2131	2244
W3D1851 L or R	8.6	1863	1909	1952	2016	2086	2190	2294
W3D2451 L or R	11.2	1935	1994	2027	2098	2167	2288	2409
W3D1554 L or R	7.7	1900	1959	2007	2064	2133	2253	2373
W3D1854 L or R	9.1	1953	2012	2050	2119	2187	2311	2435
W3D2454 L or R	11.9	2037	2098	2142	2216	2284	2417	2550
W3D1557 L or R	8.1	1981	2037	2086	2151	2225	2352	2479
W3D1857 L or R	9.6	2033	2096	2136	2210	2283	2417	2551
W3D2457 L or R	12.5	2122	2187	2235	2312	2386	2527	2668
W3D1560 L or R	8.5	2037	2098	2142	2216	2284	2419	2554
W3D1860 L or R	10.1	2088	2152	2205	2277	2366	2499	2632
W3D2460 L or R	13.2	2183	2252	2293	2377	2466	2614	2762

- 48"-54" high includes two adjustable shelves. 57"-60" high includes three adjustable shelves.
- Includes three standard drawers.
- Countertop backsplash must stop to set cabinet against wall.
- Inset and Beaded Inset Door Styles are a standard 13" deep.
- When Inset and Beaded Inset Door Styles are selected, drawers will be slab.
- Full Overlay Styles:
 - Increased Depths available in 1/4" increments from 12 1/4" to 30".
 - Reduced Depths available in 1/4" increments from 6" to 11 3/4".
- Inset and Beaded Inset Styles:
 - Increased Depths available in 1/4" increments from 13 1/4" to 30".
 - Reduced Depths available in 1/4" increments from 6" to 12 3/4".

Door & Drawer Options

AF	AOMD	CC	CG	GAMD	HC	IFHG	MC	MD	MFO	PRMD	SHMD	SPLITDR	SPLITDRWS	TCG ¹	TCP ¹
			✓			✓		✓	✓	✓				✓	✓

End Panel Options

AUTH	CSFPE	EXBK	EXDN	FFD	FL/FR	FPE	INTGE	IPE
✓	✓	✓	✓	✓			✓	✓

Custom Modification Options

ADD	SHLF	ADTK	ADRW	BVR	CBO	CCO	CFNTO	CFRMO	CLIP	CND	CSDGBK	EX	EX_OL	F.ALL	FBFL	FLUT ²	FTK	ID ³	IH	
		✓		✓	✓	✓	✓	✓	✓	✓	✓	✓	✓	✓			✓	✓	✓	✓

INVRM	IW ⁴	LIGHT	MIP	OBRB	PFINBTMB	RD	RECTK	RH	ROSLUT	RT ⁴	RW	STW	TD ⁵	TKP	TVR	WS	WTR
	✓		✓	✓	✓	✓	✓	✓	✓	✓	✓	✓	✓	✓	✓	✓	✓

¹ Not available on 48" or 51" high.

² Not available with 6" fluting.

³ Not available on W3D2448 L or R and W3D2451 L or R.

⁴ Not available on 24" wide.

⁵ Only available on 48" high and W3D2454 L or R.

IH/RH availability charts starting on page G•40.
IW/RW availability charts starting on page G•46.

WALL with THREE DRAWERS, 48", 51", 54", 57", or 60" HIGH

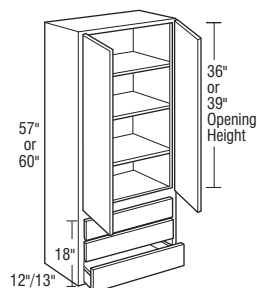
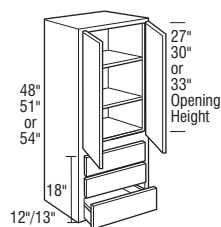

Cubic Feet	1	2	3	4	5	6	7
W3D2448	10.6	2018	2075	2117	2183	2275	2529
W3D2451	11.2	2258	2325	2376	2456	2564	2870
W3D2454	11.9	2344	2418	2466	2557	2668	3002
W3D2457	12.5	2450	2530	2580	2680	2797	3159
W3D2460	13.2	2491	2574	2630	2728	2847	3215

- 48"-54" high includes two adjustable shelves. 57"-60" high includes three adjustable shelves.
- Includes three standard drawers.
- Countertop backsplash must stop to set cabinet against wall.
- Inset and Beaded Inset Door Styles are a standard 13" deep.
- When Inset and Beaded Inset Door Styles are selected, drawers will be slab.
- Full Overlay Styles:
 - Increased Depths available in 1/4" increments from 12 1/4" to 30".
 - Reduced Depths available in 1/4" increments from 6" to 11 3/4".
- Inset and Beaded Inset Styles:
 - Increased Depths available in 1/4" increments from 13 1/4" to 30".
 - Reduced Depths available in 1/4" increments from 6" to 12 3/4".

Door & Drawer Options

AF	AOMD	CC	CG	GAMD	HC	IFHG	MC	MD	MFO	PRMD	SHMD	SPLITDR	SPLITDRWS	TCG ¹	TCP ¹
		✓				✓		✓	✓	✓		✓		✓	✓

End Panel Options

AUTH	CSFPE	EXBK	EXDN	FFD	FL/FR	FPE	INTGE	IPE
✓	✓	✓	✓	✓	✓	✓	✓	✓

Custom Modification Options

ADD	SHLF	ADDTK	ADRW	BVR	CBO	CCO	CFNTO	CFRMO	CLIP	CND	CSDGBK	EX	EX_OL	FALL	FBFL	FLUT ²	FTK	ID ³	IH
	✓			✓	✓	✓	✓	✓	✓	✓	✓	✓	✓	✓		✓	✓	✓	✓

INVFRM	IW	LIGHT	MIP	OBRB	PFINBTMB	RD	RECTK	RH	ROSELUT	RT	RW	STW	TD ⁴	TKP	TVR	WS	WTR
✓	✓	✓	✓	✓	✓	✓	✓	✓	✓	✓	✓	✓	✓	✓	✓	✓	✓

¹ Not available on 48" or 54" high.

² Not available with 6" fluting.

³ Not available on W3D2451 and W3D2454.

⁴ Only available on 48" high

Stacked Wall Cabinets

STACKED WALL with APPLIANCE GARAGE, 36" or 39" HIGH

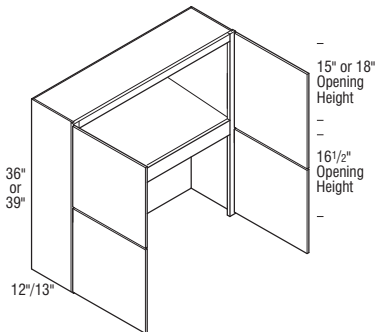
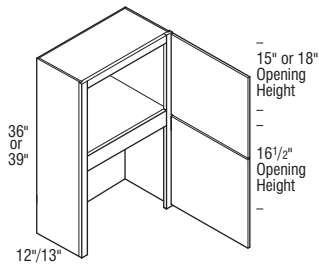

	Cubic Feet	1	2	3	4	5	6	7
STWDAG1536 L or R	5.2	995	1046	1085	1143	1209	1313	1417
STWDAG1836 L or R	6.1	1037	1089	1131	1191	1261	1368	1475
STWDAG2136 L or R	7.1	1078	1133	1176	1240	1311	1422	1533
STWDAG2436 L or R	8.0	1123	1180	1226	1290	1365	1481	1597
STWDAG1539 L or R	5.6	1108	1165	1209	1273	1347	1460	1573
STWDAG1839 L or R	6.6	1154	1213	1258	1325	1404	1522	1640
STWDAG2139 L or R	7.6	1204	1266	1314	1384	1465	1589	1713
STWDAG2439 L or R	8.7	1252	1316	1367	1439	1522	1652	1782
STWDAG2436	8.0	1474	1549	1608	1693	1791	1944	2097
STWDAG2736	9.0	1635	1717	1783	1878	1987	2156	2325
STWDAG3036	9.9	1704	1789	1858	1957	2072	2249	2426
STWDAG3336	10.9	1774	1864	1935	2038	2156	2340	2524
STWDAG3636	11.8	1848	1942	2015	2122	2246	2437	2628
STWDAG2439	8.7	1644	1725	1792	1887	1998	2169	2340
STWDAG2739	9.7	1823	1915	1988	2095	2217	2406	2595
STWDAG3039	10.7	1899	1994	2070	2180	2308	2505	2702
STWDAG3339	11.7	1978	2079	2158	2272	2405	2609	2813
STWDAG3639	12.7	2061	2165	2249	2369	2507	2720	2933

Notes below apply to all products in section above:

- Appliance garage opening is 16 1/2".
- Increased Heights modification will increase the height of the upper cabinet section. The bottom section will retain its original height.
- Bottom section does not include floor.
- Full Overlay Styles:
 - Increased Depths available in 1/4" increments from 12 1/4" to 30".
 - Reduced Depths available in 1/4" increments from 6" to 11 3/4".
- Inset and Beaded Inset Styles:
 - Increased Depths available in 1/4" increments from 13 1/4" to 30".
 - Reduced Depths available in 1/4" increments from 6" to 12 3/4".

Door & Drawer Options

AF	AQMD	CC	CG	GAMD	HC	IFHG	MC	MD	MFO	PRMD ¹	SHMD	SPLITDR	SPLITDRWS	TCG	TCP
✓	✓	✓	✓	✓	✓	✓	✓	✓	✓	✓	✓	✓	✓	✓	✓

End Panel Options

AUTH	CSFPE	EXBK	EXDN	FFD	FL/FR	FPE	INTGE	IPE
✓	✓	✓	✓	✓	✓	✓	✓	✓

Custom Modification Options

ADD	SHLF	ADTK	ADRW	BVR	CBO	CCO	CFNTD	CFRMO	CLIP ¹	CND	CSDGBK	EX	EX_OL	FALL	FBFL	FLUT ²	FTK	ID	IH
✓	✓	✓	✓	✓	✓	✓	✓	✓	✓	✓	✓	✓	✓	✓	✓	✓	✓	✓	✓

INVERM	IW ³	LIGHT	MIP	OBRB	PFINBTMB	RD	RECTK	RH	ROSLUT	RT	RW	STW	TD	TKP	TVR	WS ⁴	WTR
✓	✓	✓	✓	✓	✓	✓	✓	✓	✓	✓	✓	✓	✓	✓	✓	✓	✓

¹ Not available on 24" (2 doors) wide.

² Not available with 6" fluting.

³ Not available on 24" (1 door) or 36" wide.

⁴ Wide stile both 3" not available on 24" (2 doors) wide.

IH/RH availability charts starting on page G•40.
IW/RW availability charts starting on page G•46.

STACKED WALL with APPLIANCE GARAGE, 42" or 45" HIGH

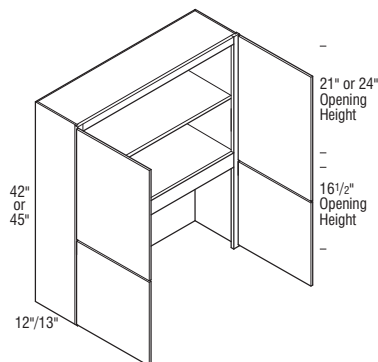
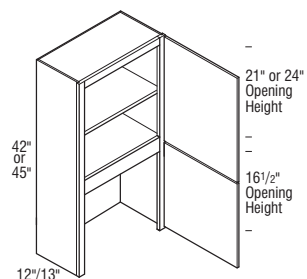

	Cubic Feet	1	2	3	4	5	6	7
STWDAG1542 L or R	6.0	1236	1299	1347	1418	1502	1630	1758
STWDAG1842 L or R	7.1	1288	1353	1405	1479	1565	1699	1833
STWDAG2142 L or R	8.2	1341	1409	1463	1540	1628	1768	1908
STWDAG2442 L or R	9.3	1397	1468	1522	1604	1698	1842	1986
STWDAG1545 L or R	6.4	1378	1448	1503	1582	1674	1817	1960
STWDAG1845 L or R	7.6	1434	1508	1566	1648	1744	1892	2040
STWDAG2145 L or R	8.8	1495	1571	1631	1717	1817	1972	2127
STWDAG2445 L or R	9.9	1557	1636	1699	1787	1892	2053	2214

STWDAG2442	9.3	1829	1924	1998	2105	2225	2416	2607
STWDAG2742	10.4	2031	2136	2217	2334	2470	2679	2888
STWDAG3042	11.5	2116	2223	2309	2430	2572	2790	3008
STWDAG3342	12.6	2206	2318	2406	2533	2681	2909	3137
STWDAG3642	13.7	2297	2414	2506	2637	2790	3027	3264
STWDAG2445	9.9	2040	2144	2224	2342	2479	2689	2899
STWDAG2745	11.1	2264	2379	2470	2601	2752	2986	3220
STWDAG3045	12.3	2358	2479	2574	2710	2866	3111	3356
STWDAG3345	13.5	2457	2581	2679	2822	2986	3239	3492
STWDAG3645	14.6	2559	2688	2790	2940	3111	3374	3637

Notes below apply to all products in section above:

- One adjustable shelf.
- Appliance garage opening is 16 1/2".
- Increased Heights modification will increase the height of the upper cabinet section. The bottom section will retain its original height.
- Bottom section does not include floor.
- Full Overlay Styles:
 - Increased Depths available in 1/4" increments from 12 1/4" to 30".
 - Reduced Depths available in 1/4" increments from 6" to 11 3/4".
- Inset and Beaded Inset Styles:
 - Increased Depths available in 1/4" increments from 13 1/4" to 30".
 - Reduced Depths available in 1/4" increments from 6" to 12 3/4".

Door & Drawer Options

AF	AOMD	CC	CG	GAMD	HC	IFHG	MC	MD	MFO	PRMD ¹	SHMD	SPLITDR	SPLITDRWS	TCG	TCP
✓			✓	✓		✓		✓	✓	✓	✓				

End Panel Options

AUTH	CSFPE	EXBK	EXDN	FFD	FL/FR	FPE	INTGE	IPE
✓	✓	✓			✓	✓	✓	✓

Custom Modification Options

ADD_SHLF	ADDTK	ADRW	BVR	CBO	CCO	CFNTD	CFRMO	CLIP ¹	CND	CSDGBK	EX	EX_OL	F.ALL	FBFL	FLUT ²	FTK	ID	IH
✓				✓	✓	✓	✓	✓	✓	✓	✓	✓	✓	✓	✓	✓	✓	✓

INVFRM	IW ³	LIGHT	MIP	OBRB	PFINBTMB	RD	RECTK	RH	ROSEFLUT	RT	RW	STW	TD	TKP	TVR	WS ⁴	WTR
	✓	✓	✓		✓	✓			✓							✓	✓

¹ Not available on 24" (2 doors) wide.

² Not available with 6" fluting.

³ Not available on 24" (1 door) or 36" wide.

⁴ Wide stile both 3" not available on 24" (2 doors) wide.

Stacked Wall Cabinets

STACKED WALL with APPLIANCE GARAGE, 48", 51", or 54" HIGH

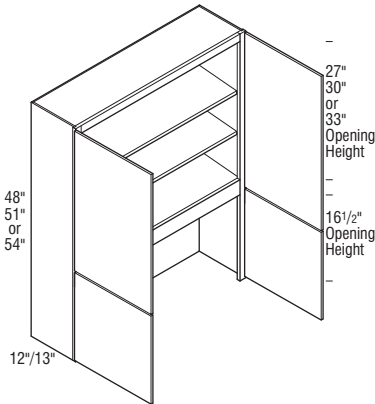
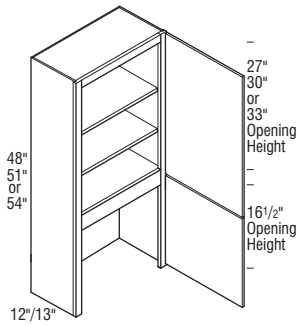

	Cubic Feet	1	2	3	4	5	6	7
STWDAG1548 L or R	6.9	1525	1615	1691	1784	1862	1994	2126
STWDAG1848 L or R	8.1	1589	1677	1759	1860	1950	2068	2186
STWDAG2148 L or R	9.3	1655	1748	1824	1922	2004	2134	2264
STWDAG2448 L or R	10.6	1751	1844	1906	2022	2134	2346	2558
STWDAG1551 L or R	8.6	1725	1826	1912	2015	2105	2248	2391
STWDAG1851 L or R	8.6	1800	1897	1987	2102	2202	2327	2452
STWDAG2151 L or R	9.9	1909	2013	2083	2209	2339	2574	2809
STWDAG2451 L or R	11.2	1977	2080	2152	2277	2407	2641	2875
STWDAG1554 L or R	7.7	1805	1904	2001	2115	2208	2359	2510
STWDAG1854 L or R	9.1	1880	1986	2074	2190	2291	2452	2613
STWDAG2154 L or R	10.5	1962	2072	2163	2264	2382	2539	2696
STWDAG2454 L or R	11.9	2067	2170	2256	2383	2511	2753	2995

STWDAG2448	10.6	2309	2428	2500	2641	2821	3087	3353
STWDAG2748	11.8	2544	2684	2779	2944	3084	3388	3692
STWDAG3048	13.1	2674	2815	2922	3084	3261	3582	3903
STWDAG3348	14.3	2770	2907	3020	3189	3388	3709	4030
STWDAG3648	15.6	2891	3035	3150	3331	3518	3847	4176
STWDAG2451	11.2	2596	2731	2816	2975	3176	3472	3768
STWDAG2751	12.6	2865	3024	3130	3315	3468	3811	4154
STWDAG3051	13.9	3010	3166	3286	3468	3666	4026	4386
STWDAG3351	15.2	3121	3272	3398	3587	3811	4168	4525
STWDAG3651	16.5	3256	3416	3547	3748	3956	4328	4700
STWDAG2454	11.9	2663	2800	2885	3047	3254	3563	3872
STWDAG2754	13.3	3013	3164	3282	3468	3650	4001	4352
STWDAG3054	14.7	3149	3310	3431	3624	3833	4202	4571
STWDAG3354	16.1	3255	3416	3549	3753	3993	4361	4729
STWDAG3654	17.5	3399	3571	3703	3911	4133	4531	4929

Notes below apply to all products in section above:

- One fixed and two adjustable shelves.
- Appliance garage opening is 16 1/2".
- Increased Heights modification will increase the height of the upper cabinet section. The bottom section will retain its original height.
- Bottom section does not include floor.
- Full Overlay Styles:
 - Increased Depths available in 1/4" increments from 12 1/4" to 30".
 - Reduced Depths available in 1/4" increments from 6" to 11 3/4".
- Inset and Beaded Inset Styles:
 - Increased Depths available in 1/4" increments from 13 1/4" to 30".
 - Reduced Depths available in 1/4" increments from 6" to 12 3/4".

Door & Drawer Options

AF	AOMD	CC	CG	GAMD	HC	IFHG	MC	MD	MFO	PRMD	SHMD	SPLITDR	SPLITDRWS	TCG	TCP
✓	✓	✓	✓	✓	✓	✓	✓	✓	✓	✓	✓	✓	✓	✓	✓

End Panel Options

AUTH	CSFPE	EXBK	EXDN	FFD	FL/FR	FPE	INTGE ¹	IPE
✓	✓	✓	✓	✓	✓	✓	✓	✓

Custom Modification Options

ADD	SHLF	ADDTK	ADRW	BVR	CBO ¹	CCO ¹	CFNTO ¹	CFRMO ¹	CLIP	CND	CSDGBK	EX	EX_OL	F.ALL	FBFL	FLUT ²	FTK	ID	IH
✓	✓	✓	✓	✓	✓	✓	✓	✓	✓	✓	✓	✓	✓	✓	✓	✓	✓	✓	✓

INVERM	IW	LIGHT	MIP	OBRB	PFINBTMB	RD	RECTK	RH	ROSFLUT	RT	RW	STW	TD	TKP	TVR	WS	WTR
✓	✓	✓	✓	✓	✓	✓	✓	✓	✓	✓	✓	✓	✓	✓	✓	✓	✓

¹ Not available on 24" (2 doors) wide.

² Not available with 6" fluting.

IH/RH availability charts starting on page G-40.
IW/RW availability charts starting on page G-46.

Stacked Wall Cabinets

STACKED WALL with APPLIANCE GARAGE, 57" or 60" HIGH

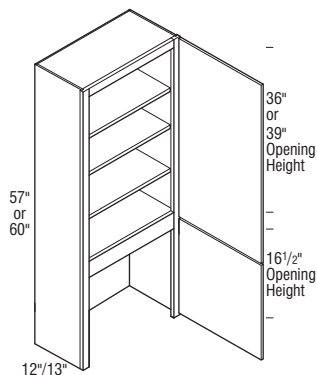

	Cubic Feet	1	2	3	4	5	6	7
STWDAG1557 L or R	8.1	1899	2005	2110	2223	2323	2484	2645
STWDAG1857 L or R	9.6	1981	2090	2185	2310	2410	2582	2754
STWDAG2157 L or R	11.0	2069	2182	2276	2399	2507	2674	2841
STWDAG2457 L or R	12.5	2174	2282	2374	2510	2640	2893	3146
STWDAG1560 L or R	8.1	1951	2061	2153	2275	2373	2542	2711
STWDAG1860 L or R	10.1	2029	2139	2245	2366	2485	2655	2825
STWDAG2160 L or R	11.6	2125	2239	2334	2471	2577	2758	2939
STWDAG2460 L or R	13.2	2223	2339	2419	2562	2708	2967	3226

STWDAG2457	12.5	2802	2946	3032	3210	3419	3747	4075
STWDAG2757	14.0	3171	3330	3452	3650	3838	4204	4570
STWDAG3057	15.5	3315	3479	3604	3810	4030	4420	4810
STWDAG3357	16.9	3315	3479	3604	2588	4190	4586	4982
STWDAG3657	18.4	3576	3758	3896	4112	4344	4764	5184
STWDAG2460	13.2	2828	2968	3066	3240	3447	3773	4099
STWDAG2760	14.7	3254	3415	3540	3740	3934	4319	4704
STWDAG3060	16.3	3387	3560	3695	3900	4111	4509	4907
STWDAG3360	17.8	3501	3673	3818	4035	4288	4831	5374
STWDAG3660	19.4	3659	3841	3973	4202	4447	4876	5305

Notes below apply to all products in section above:

- One fixed and three adjustable shelves.
- Appliance garage opening is 16 1/2".
- Increased Heights modification will increase the height of the upper cabinet section. The bottom section will retain its original height.
- Bottom section does not include floor.
- Full Overlay Styles:
 - Increased Depths available in 1/4" increments from 12 1/4" to 30".
 - Reduced Depths available in 1/4" increments from 6" to 11 3/4".
- Inset and Beaded Inset Styles:
 - Increased Depths available in 1/4" increments from 13 1/4" to 30".
 - Reduced Depths available in 1/4" increments from 6" to 12 3/4".

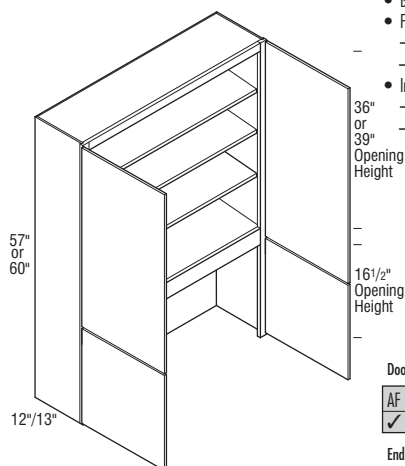

Door & Drawer Options

AF	AOMD	CC	CG	GAMD	HC	IFHG	MC	MD	MFO	PRMD	SHMD	SPLITDR	SPLITDRWS	TCG	TCP
✓			✓	✓	✓	✓	✓	✓	✓	✓	✓				

End Panel Options

AUTH	CSFPE	EXBK	EXDN	FFD	FL/FR	FPE	INTGE ¹	IPE
✓	✓	✓			✓	✓	✓	✓

Custom Modification Options

ADD_SHLF	ADDTK	ADRW	BVR	CBO ¹	CCO ¹	CFNTO ¹	CFRMO ¹	CLIP	CND	CSDGBK	EX	EX_OL	FALL	FBFL	FLUT ²	FTK	ID	IH
✓				✓	✓	✓	✓	✓	✓	✓	✓	✓	✓	✓	✓	✓	✓	✓

INVRM	IW	LIGHT	MIP	OBRB	PFINBTMB	RD	RECTK	RH	ROSLUT	RT	RW	STW	TD	TKP	TVR	WS	WTR
	✓	✓	✓		✓	✓			✓						✓	✓	✓

¹ Not available on 24" (2 doors) wide.

² Not available with 6" fluting.

Stacked Wall Cabinets

STACKED WALL, 36" or 39" HIGH

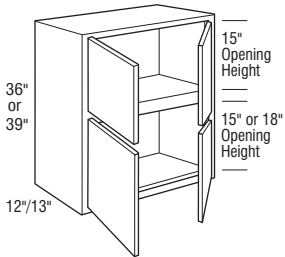
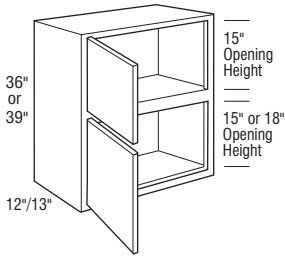

	Cubic Feet	1	2	3	4	5	6	7
STW1236 L or R	4.2	1428	1502	1559	1642	1737	1885	2033
STW1536 L or R	5.2	1486	1564	1623	1710	1810	1963	2116
STW1836 L or R	6.1	1548	1625	1687	1776	1880	2040	2200
STW2136 L or R	7.1	1609	1691	1755	1849	1956	2122	2288
STW2436 L or R	8.0	1672	1757	1823	1920	2031	2206	2381
STW1239 L or R	4.6	1486	1564	1623	1710	1810	1963	2116
STW1539 L or R	5.6	1550	1628	1690	1779	1882	2043	2204
STW1839 L or R	6.6	1612	1694	1758	1851	1958	2125	2292
STW2139 L or R	7.6	1675	1760	1827	1924	2036	2209	2382
STW2439 L or R	8.7	1742	1829	1901	2001	2117	2298	2479

STW2436	8.0	2293	2411	2502	2634	2788	3025	3262
STW2736	9.0	2389	2512	2607	2745	2904	3153	3402
STW3036	9.9	2485	2612	2711	2855	3020	3277	3534
STW3336	10.9	2585	2716	2820	2968	3139	3408	3677
STW3636	11.8	2687	2824	2932	3088	3267	3545	3823
STW3936	12.7	2795	2938	3052	3213	3398	3688	3978
STW2439	8.7	2389	2512	2607	2745	2904	3153	3402
STW2739	9.7	2489	2615	2715	2859	3025	3282	3539
STW3039	10.7	2588	2720	2823	2972	3146	3414	3682
STW3339	11.7	2692	2829	2936	3093	3272	3552	3832
STW3639	12.7	2800	2943	3056	3218	3403	3693	3983
STW3939	13.8	2913	3061	3178	3345	3538	3839	4140

Notes below apply to all products in section above:

- Inset and Beaded Inset Door Styles are a standard 13" deep.
- Full Overlay Styles:
 - Increased Depths available in 1/4" increments from 12 1/4" to 30".
 - Reduced Depths available in 1/4" increments from 6" to 11 3/4".
- Inset and Beaded Inset Styles:
 - Increased Depths available in 1/4" increments from 13 1/4" to 30".
 - Reduced Depths available in 1/4" increments from 6" to 12 3/4".
- Increased Heights modification will increase the height of the lower cabinet section. The upper cabinet section will retain its original height.

Door & Drawer Options

AF	ADMD	CC	CG	GAMD ¹	HC	IFHG	MC	MD	MFO	PRMD ¹	SHMD	SPLITDR ²	SPLITDRWS	TCG	TCP
✓	✓	✓	✓	✓	✓	✓	✓	✓	✓	✓	✓	✓	✓	✓	✓

End Panel Options

AUTH	CSFPE	EXBK	EXDN	FFD	FL/FR	FPE	INTGE	IPE
✓	✓	✓	✓	✓	✓	✓	✓	✓

Custom Modification Options

ADD_SHLF	ADDTK	ADRW	BVR	CBO	CCO	CFNTO	CFRMO	CLIP ³	CND	CSDGBK	EX	EX_OL	FALL	FBFL	FLUT ⁴	FTK ⁵	ID	IH
✓	✓	✓	✓	✓	✓	✓	✓	✓	✓	✓	✓	✓	✓	✓	✓	✓	✓	✓

INVFRM	IW ⁶	LIGHT	MIP	OBRB	PFINBTMB	RD	RECTK	RH	ROSFLUT	RT	RW	STW	TD	TKP	TVR ⁷	WS ⁸	WTR
✓	✓	✓	✓	✓	✓	✓	✓	✓	✓	✓	✓	✓	✓	✓	✓	✓	✓

¹ Not available on 12" or 24" (2 doors) wide.

² Not available on 12"-24" (1 door) wide.

³ Not available on 12" wide.

⁴ Not available with 6" fluting.

⁵ FTKAV and style B-L not available on 12" wide.

⁶ Not available on 24" (1 door) or 48" wide.

⁷ TVRAV and style B-L not available on 12" wide.

⁸ Wide stile both 3" not available on 12" or 24" (2 doors) wide.

IH/RH availability charts starting on page G-40.
IW/RW availability charts starting on page G-46.

STACKED WALL, 36" or 39" HIGH (cont'd)

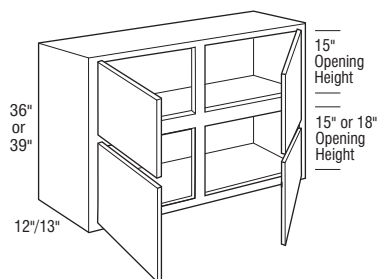

	Cubic Feet	1	2	3	4	5	6	7
STW4236	13.7	2908	3056	3170	3337	3532	3832	4132
STW4536	14.6	3024	3179	3299	3475	3677	3991	4305
STW4836	15.6	3144	3304	3430	3613	3822	4146	4470
STW4239	14.8	3027	3182	3304	3480	3682	3994	4306
STW4539	15.8	3149	3310	3435	3618	3827	4153	4479
STW4839	16.8	3276	3442	3574	3764	3983	4323	4663

Notes below apply to all products in section above:

- Inset and Beaded Inset Door Styles are a standard 13" deep.
- Full Overlay Styles:
 - Increased Depths available in 1/4" increments from 12 1/4" to 30".
 - Reduced Depths available in 1/4" increments from 6" to 11 3/4".
- Inset and Beaded Inset Styles:
 - Increased Depths available in 1/4" increments from 13 1/4" to 30".
 - Reduced Depths available in 1/4" increments from 6" to 12 3/4".
- Increased Heights modification will increase the height of the lower cabinet section. The upper cabinet section will retain its original height.

Door & Drawer Options

AF	AOMD	CC	CG	GAMD ¹	HC	IFHG	MC	MD	MFO	PRMD ¹	SHMD	SPLITDR ²	SPLITDRWS	TCG	TCP
✓			✓	✓		✓		✓	✓	✓	✓	✓			

End Panel Options

AUTH	CSFPE	EXBK	EXDN	FFD	FL/FR	FPE	INTGE	IPE
✓	✓	✓	✓	✓	✓	✓	✓	✓

Custom Modification Options

ADD_SHLF	ADDTK	ADRW	BVR	CBO	CCO	CFNTO	CFRMO	CLIP ³	CND	CSDGBK	EX	EX_OL	FALL	FBFL	FLUT ⁴	FTK ⁵	ID	IH
	✓	✓	✓	✓	✓	✓	✓	✓	✓	✓	✓	✓	✓	✓	✓	✓	✓	✓

INVFRM	IW ⁶	LIGHT	MIP	OBRB	PFINBTMB	RD	RECTK	RH	ROSLUT	RT	RW	STW	TD	TKP	TVR ⁷	WS ⁸	WTR
✓	✓	✓	✓	✓	✓	✓	✓	✓	✓	✓	✓	✓	✓	✓	✓	✓	✓

¹ Not available on 12" or 24" (2 doors) wide.

² Not available on 12"×24" (1 door) wide.

³ Not available on 12" wide.

⁴ Not available with 6" fluting.

⁵ FTKAV and style B-L not available on 12" wide.

⁶ Not available on 24" (1 door) or 48" wide.

⁷ TVRAV and style B-L not available on 12" wide.

⁸ Wide stile both 3" not available on 12" or 24" (2 doors) wide.

Stacked Wall Cabinets

STACKED WALL, 42" or 45" HIGH

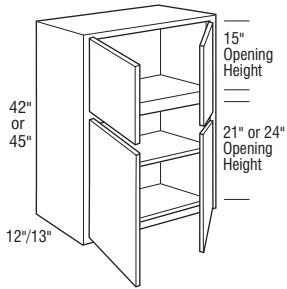
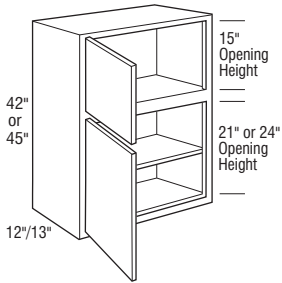

	Cubic Feet	1	2	3	4	5	6	7
STW1242 L or R	4.9	1550	1628	1690	1779	1882	2043	2204
STW1542 L or R	6.0	1614	1698	1760	1854	1961	2127	2293
STW1842 L or R	7.1	1678	1763	1829	1926	2038	2212	2386
STW2142 L or R	8.2	1746	1834	1904	2005	2121	2303	2485
STW2442 L or R	9.3	1816	1908	1981	2086	2208	2394	2580
STW1245 L or R	5.3	1614	1698	1760	1854	1961	2127	2293
STW1545 L or R	6.4	1680	1767	1833	1929	2041	2216	2391
STW1845 L or R	7.6	1748	1837	1907	2008	2123	2305	2487
STW2145 L or R	8.8	1818	1910	1983	2089	2212	2400	2588
STW2445 L or R	9.9	1890	1986	2062	2172	2298	2492	2686

STW2442	9.3	2489	2615	2715	2859	3025	3282	3539
STW2742	10.4	2592	2725	2828	2979	3153	3421	3689
STW3042	11.5	2695	2833	2941	3096	3277	3556	3835
STW3342	12.6	2805	2948	3061	3223	3411	3700	3989
STW3642	13.7	2918	3066	3182	3351	3545	3847	4149
STW3942	14.8	3032	3187	3310	3485	3687	3999	4311
STW2445	9.9	2592	2725	2828	2979	3153	3421	3689
STW2745	11.1	2700	2837	2946	3104	3283	3563	3843
STW3045	12.3	2810	2952	3064	3228	3416	3705	3994
STW3345	13.5	2922	3069	3186	3357	3552	3854	4156
STW3645	14.6	3037	3192	3315	3490	3693	4007	4321
STW3945	15.8	3160	3320	3447	3629	3839	4167	4495

Notes below apply to all products in section above:

- One adjustable shelf.
- Inset and Beaded Inset Door Styles are a standard 13" deep.
- Full Overlay Styles:
 - Increased Depths available in 1/4" increments from 12 1/4" to 30".
 - Reduced Depths available in 1/4" increments from 6" to 11 3/4".
- Inset and Beaded Inset Styles:
 - Increased Depths available in 1/4" increments from 13 1/4" to 30".
 - Reduced Depths available in 1/4" increments from 6" to 12 3/4".
- Increased Heights modification will increase the height of the lower cabinet section. The upper cabinet section will retain its original height.

Door & Drawer Options

AF	AOMD	CC	CG	GAMD ¹	HC	IFHG	MC	MD	MFO	PRMD ¹	SHMD	SPLITDR ²	SPLITDRWS	TCG	TCP
✓		✓	✓	✓	✓	✓	✓	✓	✓	✓	✓	✓	✓		

End Panel Options

AUTH	CSFPE	EXBK	EXDN	FFD	FL/FR	FPE	INTGE	IPE
✓	✓	✓	✓	✓	✓	✓	✓	✓

Custom Modification Options

ADD_SHLF	ADDTK	ADRW	BVR	CBO	CCO	CFNTO	CFRMO	CLIP ³	CND	CSDGBK	EX_EX_OL	FALL	FBFL	FLUT ⁴	FTK ⁵	ID	IH
✓	✓	✓	✓	✓	✓	✓	✓	✓	✓	✓	✓	✓	✓	✓	✓	✓	✓

INVRM	IW ⁶	LIGHT	MIP	OBRB	PFINBTMB	RD	RECTK	RH	ROSLUT	RT	RW	STW	TD	TKP	TVR ⁷	WS ⁸	WTR
✓	✓	✓	✓	✓	✓	✓	✓	✓	✓	✓	✓	✓	✓	✓	✓	✓	✓

¹ Not available on 12" or 24" (2 doors) wide.

² Not available on 12"-24" (1 door) wide.

³ Not available on 12" wide.

⁴ Not available with 6" fluting.

⁵ FTKAV and style B-L not available on 12" wide.

⁶ Not available on 24" (1 door) or 48" wide.

⁷ TVRAV and style B-L not available on 12" wide.

⁸ Wide stile both 3" not available on 12" or 24" (2 doors) wide.

IH/RH availability charts starting on page G-40.
IW/RW availability charts starting on page G-46.

STACKED WALL, 42" or 45" HIGH (cont'd)

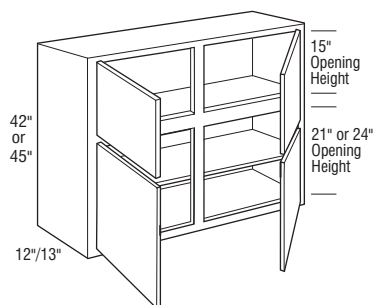

	Cubic Feet	1	2	3	4	5	6	7
STW4242	15.9	3155	3315	3440	3623	3832	4158	4484
STW4542	17.0	3281	3448	3580	3769	3988	4328	4668
STW4842	18.1	3414	3586	3723	3919	4144	4498	4852
STW4245	17.0	3286	3453	3585	3774	3993	4333	4673
STW4545	18.1	3419	3591	3727	3927	4154	4507	4860
STW4845	19.3	3554	3735	3878	4084	4322	4689	5056

- One adjustable shelf.
- Inset and Beaded Inset Door Styles are a standard 13" deep.
- Full Overlay Styles:
 - Increased Depths available in 1/4" increments from 12 1/4" to 30".
 - Reduced Depths available in 1/4" increments from 6" to 11 3/4".
- Inset and Beaded Inset Styles:
 - Increased Depths available in 1/4" increments from 13 1/4" to 30".
 - Reduced Depths available in 1/4" increments from 6" to 12 3/4".
- Increased Heights modification will increase the height of the lower cabinet section. The upper cabinet section will retain its original height.

Door & Drawer Options

AF	AOMD	CC	CG	GAMD ¹	HC	IFHG	MC	MD	MFO	PRMD ¹	SHMD	SPLITDR ²	SPLITDRWS	TCG	TCP
✓			✓	✓		✓		✓	✓	✓	✓	✓			

End Panel Options

AUTH	CSFPE	EXBK	EXDN	FFD	FL/FR	FPE	INTGE	IPE
✓	✓	✓	✓	✓	✓	✓	✓	✓

Custom Modification Options

ADD_SHLF	ADDTK	ADRW	BVR	CBO	CCO	CFNTO	CFRMO	CLIP ³	CND	CSDGBK	EX	EX_OL	FALL	FBFL	FLUT ⁴	FTK ⁵	ID	IH
✓	✓	✓	✓	✓	✓	✓	✓	✓	✓	✓	✓	✓	✓	✓	✓	✓	✓	✓
INVERM	IW ⁶	LIGHT	MIP	OBRB	PFINBTMB	RD	RECTK	RH	ROSLUT	RT	RW	STW	TD	TKP	TVR ⁷	WS ⁸	WTR	
✓	✓	✓	✓	✓	✓	✓	✓	✓	✓	✓	✓	✓	✓	✓	✓	✓	✓	

¹ Not available on 12" or 24" (2 doors) wide.

² Not available on 12"-24" (1 door) wide.

³ Not available on 12" wide.

⁴ Not available with 6" fluting.

⁵ FTKAV and style B-L not available on 12" wide.

⁶ Not available on 24" (1 door) or 48" wide.

⁷ TVRAV and style B-L not available on 12" wide.

⁸ Wide stile both 3" not available on 12" or 24" (2 doors) wide.

Stacked Wall Cabinets

STACKED WALL, 48" or 51" HIGH

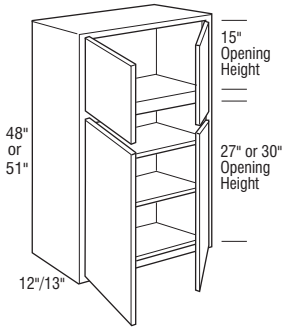
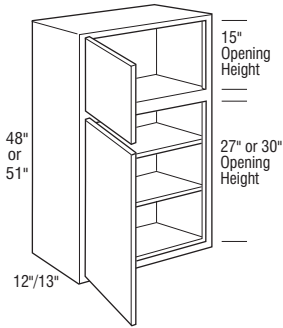

	Cubic Feet	1	2	3	4	5	6	7
STW1248 L or R	5.6	1667	1757	1838	1942	2019	2187	2355
STW1548 L or R	6.9	1744	1838	1918	2015	2097	2235	2373
STW1848 L or R	8.1	1810	1902	1988	2095	2187	2312	2437
STW2148 L or R	9.3	1878	1977	2058	2159	2245	2382	2519
STW2448 L or R	10.6	1979	2075	2139	2265	2382	2603	2824
STW1251 L or R	5.9	1869	1970	2059	2172	2257	2452	2647
STW1551 L or R	7.3	1954	2059	2149	2256	2351	2501	2651
STW1851 L or R	8.6	2029	2132	2227	2348	2452	2585	2718
STW2151 L or R	9.9	2106	2212	2305	2419	2516	2667	2818
STW2451 L or R	11.2	2216	2325	2399	2532	2667	2913	3159
STW2448	10.6	2564	2689	2764	2913	3100	3382	3664
STW2748	11.8	2812	2960	3058	3232	3379	3697	4015
STW3048	13.1	2946	3094	3207	3379	3564	3900	4236
STW3348	14.3	3050	3191	3312	3489	3697	4034	4371
STW3648	15.6	3176	3326	3448	3638	3833	4178	4523
STW3948	16.8	3323	3485	3607	3804	4028	4402	4776
STW2451	11.2	2866	3009	3095	3262	3474	3785	4096
STW2751	12.6	3148	3315	3426	3620	3782	4141	4500
STW3051	13.9	3299	3464	3590	3782	3988	4367	4746
STW3351	15.2	3417	3575	3708	3905	4141	4515	4889
STW3651	16.5	3559	3726	3864	4076	4293	4682	5071
STW3951	17.8	3723	3901	4040	4256	4509	4929	5349

Notes below apply to all products in section above:

- Two adjustable shelves.
- Inset and Beaded Inset Door Styles are a standard 13" deep.
- Full Overlay Styles:
 - Increased Depths available in 1/4" increments from 12 1/4" to 30".
 - Reduced Depths available in 1/4" increments from 6" to 11 3/4".
- Inset and Beaded Inset Styles:
 - Increased Depths available in 1/4" increments from 13 1/4" to 30".
 - Reduced Depths available in 1/4" increments from 6" to 12 3/4".
- Increased Heights modification will increase the height of the lower cabinet section. The upper cabinet section will retain its original height.

Door & Drawer Options

AF	AQMD	CC	CG	GAMD	HC	IFHG	MC	MD	MFO	PRMD ¹	SHMD	SPLITDR ²	SPLITDRWS	TCG	TCP
✓			✓	✓		✓		✓	✓	✓	✓	✓	✓		

End Panel Options

AUTH	CSFPE	EXBK	EXDN	FFD	FL/FR	FPE	INTGE	IPE
✓	✓	✓	✓	✓	✓	✓	✓	✓

Custom Modification Options

ADD_SHLF	ADDTK	ADRW	BVR	CBO	CCO	CFNTO	CFRMO	CLIP ¹	CND	CSDGBK	EX	EX_OL	FALL	FBFL	FLUT ³	FTK ⁴	ID	IH
✓	✓	✓	✓	✓	✓	✓	✓	✓	✓	✓	✓	✓	✓	✓	✓	✓	✓	✓
INVFRM	IW ⁵	LIGHT	MIP	OBRB	PFINBTMB	RD	RECTK	RH	ROSFLUT	RT	RW	STW	TD	TKP	TVR ⁶	WS ⁷	WTR	
✓	✓	✓	✓	✓	✓	✓	✓	✓	✓	✓	✓	✓	✓	✓	✓	✓	✓	

¹ Not available on 12" or 24" (2 doors) wide.

² Only available on 24" (2 doors)-39" wide.

³ Not available with 6" fluting.

⁴ FTKAV and style B-L not available on 12" wide.

⁵ Not available on 24" (1 door) or 48" wide.

⁶ Not available on 42"-48" wide and TVRAV and style B-L not available on 12" wide.

⁷ Not available on 24" (2 doors) wide and wide stile both 3" not available on 12" wide.

IH/RH availability charts starting on page G-40.
IW/RW availability charts starting on page G-46.

STACKED WALL, 48" or 51" HIGH (cont'd)

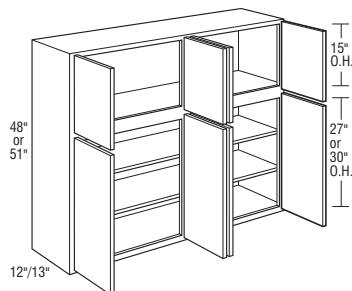
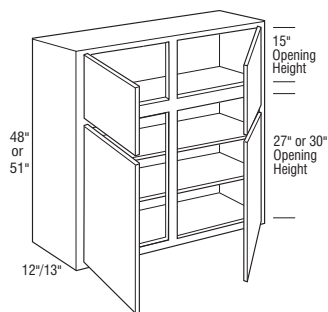

	Cubic Feet	1	2	3	4	5	6	7
STW4248	18.1	3456	3622	3756	3966	4167	4558	4949
STW4548	19.3	3608	3782	3907	4126	4331	4734	5137
STW4848CS	20.6	3754	3930	4066	4290	4516	4935	5354
STW4251	19.2	3871	4053	4206	4440	4670	5103	5536
STW4551	20.5	4041	4234	4373	4623	4846	5301	5756
STW4851CS	21.8	4204	4403	4550	4803	5063	5530	5997
<hr/>								
STW4848	20.6	4204	4402	4554	4805	5058	5527	5996
STW4851	21.8	4708	4931	5096	5379	5671	6194	6717

- Two adjustable shelves.
- Inset and Beaded Inset Door Styles are a standard 13" deep.
- Full Overlay Styles:
 - Increased Depths available in 1/4" increments from 12 1/4" to 30".
 - Reduced Depths available in 1/4" increments from 6" to 11 3/4".
- Inset and Beaded Inset Styles:
 - Increased Depths available in 1/4" increments from 13 1/4" to 30".
 - Reduced Depths available in 1/4" increments from 6" to 12 3/4".
- Increased Heights modification will increase the height of the lower cabinet section. The upper cabinet section will retain its original height.

Door & Drawer Options

AF	AOMD	CC	CG	GAMD	HC	IFHG	MC	MD	MFO	PRMD ¹	SHMD	SPLITDR ²	SPLITDRWS	TCG	TCP
✓	✓	✓	✓	✓	✓	✓	✓	✓	✓	✓	✓	✓	✓	✓	✓

End Panel Options

AUTH	CSPE	EXBK	EXDN	FFD	FL/FR	FPE	INTGE	IPE
✓	✓	✓	✓	✓	✓	✓	✓	✓

Custom Modification Options

ADD	SHLF	ADDTK	ADRW	BVR	CBO	CCO	CFNTO	CFRMO	CLIP ¹	CND	CSDGBK	EX	EX_OL	FALL	FBFL	FLUT ³	FTK ⁴	ID	IH
✓	✓	✓	✓	✓	✓	✓	✓	✓	✓	✓	✓	✓	✓	✓	✓	✓	✓	✓	✓

INVRM	IW ⁵	LIGHT	MIP	OBRB	PFINBTMB	RD	RECTK	RH	ROSLUT	RT	RW	STW	TD	TKP	TVR	WS ⁶	WTR
✓	✓	✓	✓	✓	✓	✓	✓	✓	✓	✓	✓	✓	✓	✓	✓	✓	✓

¹ Not available on 12" or 24" (2 doors) wide.

² Only available on 24" (2 doors)-39" wide.

³ Not available with 6" fluting.

⁴ FTKAV and style B-L not available on 12" wide.

⁵ Not available on 24" (1 door) or 48" wide.

⁶ Not available on 24" (2 doors) wide and wide stile both 3" not available on 12" wide.

Stacked Wall Cabinets

STACKED WALL, 54", 57", or 60" HIGH

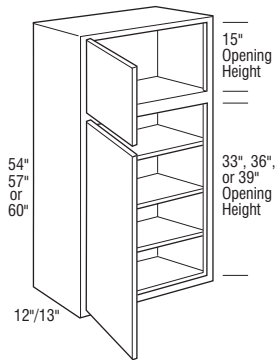

	Cubic Feet	1	2	3	4	5	6	7
STW1254 L or R	6.3	1956	2061	2145	2266	2367	2561	2755
STW1554 L or R	7.7	2035	2138	2241	2361	2458	2618	2778
STW1854 L or R	9.1	2116	2225	2319	2441	2545	2715	2885
STW2154 L or R	10.5	2203	2315	2412	2532	2642	2805	2968
STW2454 L or R	11.9	2310	2419	2510	2644	2777	3030	3283
STW1257 L or R	6.6	2056	2161	2252	2378	2482	2689	2896
STW1557 L or R	8.1	2134	2246	2357	2475	2578	2749	2920
STW1857 L or R	9.6	2220	2336	2436	2566	2672	2853	3034
STW2157 L or R	11.0	2313	2431	2530	2658	2770	2946	3122
STW2457 L or R	12.5	2422	2538	2631	2774	2912	3179	3446
STW1260 L or R	7.0	2105	2212	2310	2432	2551	2764	2977
STW1560 L or R	8.5	2188	2305	2400	2528	2630	2808	2986
STW1860 L or R	10.1	2272	2387	2498	2624	2751	2927	3103
STW2160 L or R	11.6	2372	2491	2591	2733	2847	3035	3223
STW2460 L or R	13.2	2475	2594	2681	2831	2981	3256	3531

- Three adjustable shelves.
- Inset and Beaded Inset Door Styles are a standard 13" deep.
- Full Overlay Styles:
 - Increased Depths available in 1/4" increments from 12 1/4" to 30".
 - Reduced Depths available in 1/4" increments from 6" to 11 3/4".
- Inset and Beaded Inset Styles:
 - Increased Depths available in 1/4" increments from 13 1/4" to 30".
 - Reduced Depths available in 1/4" increments from 6" to 12 3/4".
- Increased Heights modification will increase the height of the lower cabinet section. The upper cabinet section will retain its original height.

Door & Drawer Options

AF	AOMD	CC	CG	GAMD	HC	IFHG	MC	MD	MFO	PRMD ¹	SHMD	SPLITDR	SPLITDRWS	TCG	TCP
✓	✓	✓	✓	✓	✓	✓	✓	✓	✓	✓	✓	✓	✓	✓	✓

End Panel Options

AUTH	CSFPE	EXBK	EXDN	FFD	FL/FR	FPE	INTGE	IPE
✓	✓	✓	✓	✓	✓	✓	✓	✓

Custom Modification Options

ADD	SHLF	ADTK	ADRW	BVR	CBO	CCO	CFNTO	CFRMO	CLIP ¹	CND	CSDGBK	EX	EX_OL	FALL	FBFL	FLUT ²	FTK ³	ID	IH
✓	✓	✓	✓	✓	✓	✓	✓	✓	✓	✓	✓	✓	✓	✓	✓	✓	✓	✓	✓
INVERM	IW ⁴	LIGHT	MIP	OBRB	PFINBTMB	RD	RECTK	RH	ROSLUT	RT	RW	STW	TD	TKP	TVR ⁵	WS ⁶	WTR		
✓	✓	✓	✓	✓	✓	✓	✓	✓	✓	✓	✓	✓	✓	✓	✓	✓	✓		

¹ Not available on 12" wide.
² Not available with 6" fluting.
³ FTKAV and style B-L not available on 12" wide.
⁴ Not available on 24" wide.
⁵ TVRAV and style B-L not available on 12" wide.
⁶ Wide stile both 3" not available on 12" wide.

IH/RH availability charts starting on page G•40.
 IW/RW availability charts starting on page G•46.

Stacked Wall Cabinets

STACKED WALL, 54", 57", or 60" HIGH (cont'd)

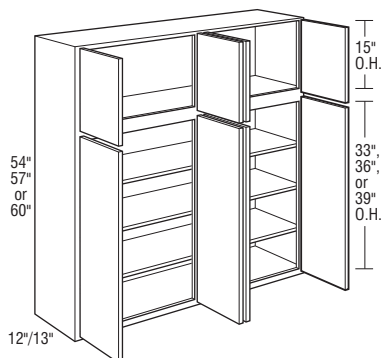
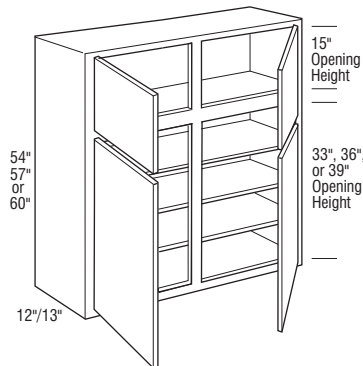
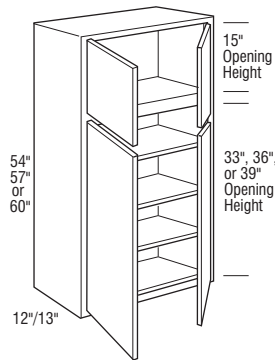

	Cubic Feet	1	2	3	4	5	6	7
STW2454	11.9	2936	3080	3169	3340	3556	3879	4202
STW2754	13.3	3302	3462	3586	3782	3971	4339	4707
STW3054	14.7	3447	3615	3741	3943	4164	4550	4936
STW3354	16.1	3558	3726	3866	4079	4319	4718	5117
STW3654	17.5	3709	3889	4028	4245	4479	4895	5311
STW3954	18.9	3855	4044	4189	4419	5111	5111	5111
STW2457	12.5	3083	3234	3324	3508	3729	4074	4419
STW2757	14.0	3469	3636	3764	3971	4169	4553	4937
STW3057	15.5	3620	3791	3925	4140	4371	4778	5185
STW3357	16.9	3730	3913	4055	4287	4538	4953	5368
STW3657	18.4	3896	4084	4229	4457	4701	5140	5579
STW3957	19.9	4046	4242	4392	4630	4905	5359	5813
STW2460	13.2	3111	3258	3358	3543	3759	4101	4443
STW2760	14.7	3556	3725	3859	4068	4270	4672	5074
STW3060	16.3	3695	3876	4020	4233	4456	4874	5292
STW3360	17.8	3817	3997	4147	4375	4640	5067	5494
STW3660	19.4	3980	4173	4311	4550	4809	5258	5707
STW3960	20.9	4125	4329	4475	4731	5001	5466	5931
STW4254	20.3	4012	4202	4351	4600	5281	5281	5281
STW4554	21.7	4192	4394	4550	4803	5035	5499	5963
STW4854CS	23.1	4359	4568	4731	4985	5242	5733	6224
STW4257	21.4	4174	4375	4530	4777	5061	5525	5989
STW4557	22.8	4402	4612	4778	5040	5285	5770	6255
STW4857CS	24.3	4576	4796	4964	5236	5504	6014	6524
STW4260	22.4	4290	4499	4664	4918	5163	5640	6117
STW4560	24.0	4475	4689	4849	5125	5376	5883	6390
STW4860CS	25.5	4651	4884	5063	5338	5613	6130	6647
STW4854	23.1	4926	5162	5346	5633	5923	6478	7033
STW4857	24.3	5171	5419	5609	5917	6220	6796	7372
STW4860	25.5	5256	5519	5721	6032	6343	6927	7511

- Three adjustable shelves.
- Inset and Beaded Inset Door Styles are a standard 13" deep.
- Full Overlay Styles:
 - Increased Depths available in 1/4" increments from 12 1/4" to 30".
 - Reduced Depths available in 1/4" increments from 6" to 11 3/4".
- Inset and Beaded Inset Styles:
 - Increased Depths available in 1/4" increments from 13 1/4" to 30".
 - Reduced Depths available in 1/4" increments from 6" to 12 3/4".
- Increased Heights modification will increase the height of the lower cabinet section. The upper cabinet section will retain its original height.

Door & Drawer Options

AF	AOMD	CC	CG	GAMD	HC	IFHG	MC	MD	MFO	PRMD ¹	SHMD	SPLITDR ²	SPLITDRWS	TCG	TCP
✓	✓	✓	✓	✓	✓	✓	✓	✓	✓	✓	✓	✓	✓	✓	✓

End Panel Options

AUTH	CSFPE	EXBK	EXDN	FFD	FL/FR	FPE	INTGE	IPE
✓	✓	✓	✓	✓	✓	✓	✓	✓

Custom Modification Options

ADD_SHLF	ADDTK	ADRW	BVR	CBO	CCO	CFNTO	CFRMO	CLIP ¹	CND	CSDGBK	EX	EX_OL	F.ALL	FBFL	FLUT ³	FTK	ID	IH
✓	✓	✓	✓	✓	✓	✓	✓	✓	✓	✓	✓	✓	✓	✓	✓	✓	✓	✓

INVFRM	IW ⁴	LIGHT	MIP	OBRB	PFINBTMB	RD	RECTK	RH	ROSLUT	RT	RW	STW	TD	TKP	TVR ⁵	WS ¹	WTR
✓	✓	✓	✓	✓	✓	✓	✓	✓	✓	✓	✓	✓	✓	✓	✓	✓	✓

¹ Not available on 24" wide.
² Not available on 42"-48" wide.
³ Not available with 6" fluting.
⁴ Not available on 36" or 48" wide.
⁵ Not available on 42"-60" wide.

Stacked Wall Cabinets

STACKED WALL with VERTICAL-LIFT, 36", 39", 42" or 45" HIGH

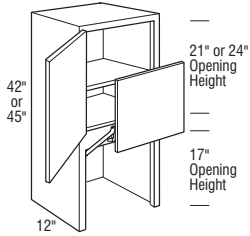
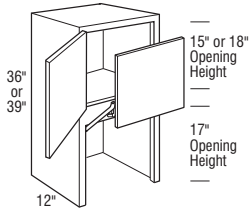

	Cubic Feet	1	2	3	4	5	6	7
STWAG1536 L or R	5.2	2576	2708	2811	2960	3131	3397	3663
STWAG1836 L or R	6.1	2601	2732	2836	2987	3160	3428	3696
STWAG2136 L or R	7.1	2628	2762	2868	3021	3196	3469	3742
STWAG2436 L or R	8.0	2681	2818	2925	3082	3260	3537	3814
STWAG1539 L or R	5.6	2668	2804	2911	3064	3243	3520	3797
STWAG1839 L or R	6.6	2694	2832	2940	3095	3276	3554	3832
STWAG2139 L or R	7.6	2722	2861	2970	3127	3308	3590	3872
STWAG2439 L or R	8.7	2779	2920	3031	3192	3378	3665	3952
STWAG1542 L or R	6.0	2775	2917	3027	3189	3373	3661	3949
STWAG1842 L or R	7.1	2804	2946	3059	3222	3409	3698	3987
STWAG2142 L or R	8.2	2832	2977	3089	3254	3441	3735	4029
STWAG2442 L or R	9.3	2890	3036	3153	3320	3513	3811	4109
STWAG1545 L or R	6.4	2861	3008	3122	3288	3480	3775	4070
STWAG1845 L or R	7.6	2890	3036	3153	3320	3513	3811	4109
STWAG2145 L or R	8.8	2920	3068	3185	3355	3548	3849	4150
STWAG2445 L or R	9.9	2978	3130	3249	3421	3619	3927	4235

- Heavy duty Vertical-Lift mechanism.
- 36" and 39" high have no shelves. 42" and 45" high have one adjustable shelf.
- Appliance garage opening is 17" high, dimension from cabinet base to bottom of mechanism is 15 3/4".
- Increased Heights modification will increase the height of the upper cabinet section. The bottom section will retain its original height.
- Increased Depths available in 1/4" increments from 12 1/4" to 30".
- Not available on Inset and Beaded Inset styles.
- Automatic Opening Mechanism is available except when used with the following door styles:
 - Brooks, Gunther, Karis, Langley, Montgomery, Shona, or Vesta.

Door & Drawer Options

AF	AOMD	CC	CG	GAMD	HC	IFHG	MC	MD	MFO	PRMD	SHMD	SPLITDR	SPLITDRWS	TCG	TCP
✓	✓	✓	✓	✓	✓	✓	✓	✓	✓	✓	✓	✓	✓	✓	✓

End Panel Options

AUTH	CSFPE	EXBK	EXDN	FFD	FL/FR	FPE	INTGE	IPE
✓	✓	✓	✓	✓	✓	✓	✓	✓

Custom Modification Options

ADD	SHLF ¹	ADDTK	ADRW	BVR	CBO	CCO	CFNTO	CFRMO	CLIP	CND	CSDGBK	EX	EX_OL	FALL	FBFL	FLUT ²	FTK	ID	IH	
✓	✓	✓	✓	✓	✓	✓	✓	✓	✓	✓	✓	✓	✓	✓	✓	✓	✓	✓	✓	✓

INVERM	IW ³	LIGHT	MIP	OBRB	PFINBTMB	RD	RECTK	RH	ROSLUT	RT	RW	STW	TD	TKP	TVR	WS	WTR
✓	✓	✓	✓	✓	✓	✓	✓	✓	✓	✓	✓	✓	✓	✓	✓	✓	✓

¹ Not available on 36" or 39" high.

² Not available with 6" fluting.

³ Not available on 24" wide.

IH/RH availability charts starting on page G-40.
IW/RW availability charts starting on page G-46.

STACKED WALL with VERTICAL-LIFT, 36", 39", 42" or 45" HIGH (cont'd)

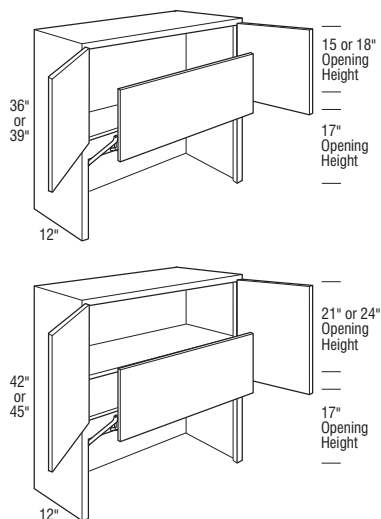

Cubic Feet	1	2	3	4	5	6	7	
STWAG2436	8.0	2884	3030	3146	3314	3506	3804	4102
STWAG2736	9.0	3010	3162	3282	3457	3657	3969	4281
STWAG3036	9.9	3139	3299	3426	3608	3818	4142	4466
STWAG3336	10.9	3277	3444	3575	3766	3985	4324	4663
STWAG3636	11.8	3381	3552	3687	3884	4108	4458	4808
STWAG2439	8.7	2988	3139	3260	3433	3633	3941	4249
STWAG2739	9.7	3118	3277	3400	3582	3790	4112	4434
STWAG3039	10.7	3255	3420	3550	3739	3956	4293	4630
STWAG3339	11.7	3395	3569	3704	3901	4128	4479	4830
STWAG3639	12.7	3502	3682	3822	4025	4258	4622	4986
STWAG2442	9.3	3109	3266	3390	3571	3778	4099	4420
STWAG2742	10.4	3237	3401	3532	3721	3937	4272	4607
STWAG3042	11.5	3367	3538	3672	3868	4092	4440	4788
STWAG3342	12.6	3508	3687	3827	4030	4264	4627	4990
STWAG3642	13.7	3615	3799	3944	4154	4395	4771	5147
STWAG2445	9.9	3186	3349	3475	3661	3873	4202	4531
STWAG2745	11.1	3320	3489	3623	3816	4036	4379	4722
STWAG3045	12.3	3458	3634	3772	3972	4202	4560	4918
STWAG3345	13.5	3602	3785	3929	4138	4378	4750	5122
STWAG3645	14.6	3711	3900	4049	4264	4510	4895	5280

- Heavy duty Vertical-Lift mechanism.
- 36" and 39" high have no shelves. 42" and 45" high have one adjustable shelf.
- Appliance garage opening is 17" high, dimension from cabinet base to bottom of mechanism is 15 3/4".
- Increased Heights modification will increase the height of the upper cabinet section. The bottom section will retain its original height.
- Increased Depths available in 1/4" increments from 12 1/4" to 30".
- Not available on Inset and Beaded Inset styles.
- Automatic Opening Mechanism is available except when used with the following door styles:
 - Brooks, Gunther, Karis, Langley, Montgomery, Shana, or Vesta.

Door & Drawer Options

AF	AOMD	CC	CG	GAMD ¹	HC	IFHG	MC	MD	MFO	PRMD ¹	SHMD	SPLITDR	SPLITDRWS	TCG	TCP
✓	✓	✓	✓	✓				✓	✓	✓	✓				✓

End Panel Options

AUTH	CSFPE	EXBK	EXDN	FFD	FL/FR	FPE	INTGE	IPE
✓	✓	✓	✓		✓	✓		

Custom Modification Options

ADD	SHLF ²	ADDTK	ADRW	BVR	CBO	CCO	CFNTO	CFRMO	CLIP ¹	CND	CSDGBK	EX	EX_OL	FALL	FBFL	FLUT ³	FTK	ID	IH
	✓								✓	✓	✓	✓	✓			✓		✓	✓

INVERM	IW ⁴	LIGHT	MIP	OBRB	PFINBTMB	RD	RECTK	RH	ROSLUT	RT	RW	STW	TD	TKP	TVR	WS ¹	WTR	
	✓	✓	✓						✓							✓	✓	✓

¹ Not available on 24" wide.
² Not available on 36" or 39" high.
³ Not available with 6" fluting.
⁴ Not available on 36" wide.

Stacked Wall Cabinets

STACKED WALL with VERTICAL-LIFT, 48", 51", 54", 57", or 60" HIGH

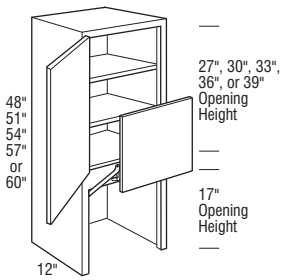

	Cubic Feet	1	2	3	4	5	6	7
STWAG1548 L or R	6.9	2941	3084	3191	3367	3566	3896	4226
STWAG1848 L or R	8.1	2968	3112	3222	3395	3596	3929	4262
STWAG2148 L or R	9.3	3005	3154	3266	3442	3646	3983	4320
STWAG2448 L or R	10.6	3071	3222	3331	3517	3725	4068	4411
STWAG1551 L or R	7.3	3037	3185	3297	3478	3686	4024	4362
STWAG1851 L or R	8.6	3063	3211	3324	3506	3714	4055	4396
STWAG2151 L or R	9.9	3106	3256	3371	3556	3764	4111	4458
STWAG2451 L or R	11.2	3178	3328	3447	3634	3849	4204	4559
STWAG1554 L or R	7.7	3066	3214	3328	3510	3719	4058	4397
STWAG1854 L or R	9.1	3098	3250	3363	3548	3758	4105	4452
STWAG2154 L or R	10.5	3139	3291	3408	3592	3805	4158	4511
STWAG2454 L or R	11.9	3211	3367	3486	3673	3892	4251	4610
STWAG1557 L or R	8.1	3187	3345	3462	3650	3868	4224	4580
STWAG1857 L or R	9.6	3224	3379	3497	3689	3905	4266	4627
STWAG2157 L or R	11.0	3267	3425	3547	3736	3960	4323	4686
STWAG2457 L or R	12.5	3337	3500	3625	3821	4046	4421	4796
STWAG1560 L or R	8.5	3184	3337	3457	3643	3862	4218	4574
STWAG1860 L or R	10.1	3218	3374	3494	3682	3901	4259	4617
STWAG2160 L or R	11.6	3266	3422	3540	3735	3957	4322	4687
STWAG2460 L or R	13.2	3330	3494	3618	3815	4040	4409	4778

- Heavy duty Vertical-Lift mechanism.
- 48", 51" and 54" high have one fixed and two adjustable shelves. 57" and 60" high have one fixed and three adjustable shelves.
- Appliance garage opening is 17" high, dimension from cabinet base to bottom of mechanism is 15 3/4".
- Increased Heights modification will increase the height of the upper cabinet section. The bottom section will retain its original height.
- Increased Depths available in 1/4" increments from 12 1/4" to 30".
- Not available on Inset and Beaded Inset styles.
- Automatic Opening Mechanism is available except when used with the following door styles:
 - Brooks, Gunther, Karis, Langley, Montgomery, Shona, or Vesta.

Door & Drawer Options

AF	AOMD	CC	CG	GAMD	HC	IFHG	MC	MD	MFO	PRMD	SHMD	SPLITDR	SPLITDRWS	TCG	TCP
✓	✓	✓	✓	✓	✓	✓	✓	✓	✓	✓	✓	✓	✓	✓	✓

End Panel Options

AUTH	CSFPE	EXBK	EXDN	FFD	FL/FR	FPE	INTGE	IPE
✓	✓	✓	✓	✓	✓	✓	✓	✓

Custom Modification Options

ADD	SHLF	ADTK	ADRW	BVR	CBO	CCO	CFNTO	CFRMO	CLIP	CND	CSDGBK	EX	EX_OL	F.ALL	FBFL	FLUT ¹	FTK	ID	IH
✓	✓	✓	✓	✓	✓	✓	✓	✓	✓	✓	✓	✓	✓	✓	✓	✓	✓	✓	✓
INVERM	IW ²	LIGHT	MIP	OBRB	PFINBTMB	RD	RECTK	RH	ROSLUT	RT	RW	STW	TD	TKP	TVR	WS	WTR		
✓	✓	✓	✓	✓	✓	✓	✓	✓	✓	✓	✓	✓	✓	✓	✓	✓	✓		

¹ Not available with 6" fluting.

² Not available on 24" wide.

IH/RH availability charts starting on page G-40.
IW/RW availability charts starting on page G-46.

STACKED WALL with VERTICAL-LIFT, 48", 51", 54", 57", or 60" HIGH (cont'd)

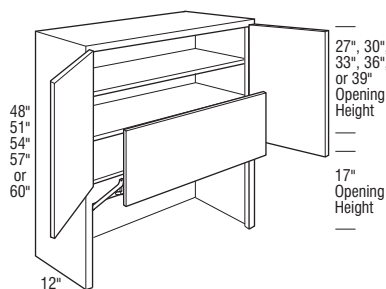

Cubic Feet	1	2	3	4	5	6	7
STWAG2448	10.6	3301	3460	3585	3777	3999	4741
STWAG2748	11.8	3447	3615	3739	3944	4176	4950
STWAG3048	13.1	3601	3777	3909	4121	4367	5177
STWAG3348	14.3	3730	3911	4050	4267	4525	5351
STWAG3648	15.6	3849	4037	4176	4405	4670	5526
STWAG2451	11.2	3416	3580	3704	3905	4138	4902
STWAG2751	12.6	3566	3737	3870	4079	4322	5120
STWAG3051	13.9	3730	3911	4050	4267	4525	5351
STWAG3351	15.2	3865	4051	4194	4421	4685	5547
STWAG3651	16.5	3992	4186	4335	4569	4838	5732
STWAG2454	11.9	3451	3620	3746	3950	4186	4956
STWAG2754	13.3	3608	3783	3918	4130	4373	5183
STWAG3054	14.7	3768	3950	4088	4311	4568	5412
STWAG3354	16.1	3917	4106	4251	4483	4746	5626
STWAG3654	17.5	4041	4234	4386	4627	4897	5803
STWAG2457	12.5	3595	3770	3902	4114	4359	5161
STWAG2757	14.0	3762	3944	4083	4304	4559	5401
STWAG3057	15.5	3930	4119	4264	4496	4767	5643
STWAG3357	16.9	4089	4288	4438	4681	4958	5872
STWAG3657	18.4	4222	4429	4581	4830	5118	6060
STWAG2460	13.2	3836	4021	4163	4389	4646	5506
STWAG2760	14.7	3847	4030	4174	4402	4666	5522
STWAG3060	16.3	3983	4175	4323	4558	4830	5722
STWAG3360	17.8	4130	4331	4486	4729	5009	5933
STWAG3660	19.4	4270	4478	4635	4885	5175	6135

- Heavy duty Vertical-Lift mechanism.
- 48", 51" and 54" high have one fixed and two adjustable shelves. 57" and 60" high have one fixed and three adjustable shelves.
- Appliance garage opening is 17" high, dimension from cabinet base to bottom of mechanism is 15 3/4".
- Increased Heights modification will increase the height of the upper cabinet section. The bottom section will retain its original height.
- Increased Depths available in 1/4" increments from 12 1/4" to 30".
- Not available on Inset and Beaded Inset styles.
- Automatic Opening Mechanism is available except when used with the following door styles:
 - Brooks, Gunther, Karis, Langley, Montgomery, Shona, or Vesta.

Door & Drawer Options

AF	AOMD	CC	CG	GAMD	HC	IFHG	MC	MD	MFO	PRMD	SHMD	SPLITDR	SPLITDRWS	TCG	TCP
✓	✓	✓	✓	✓	✓	✓	✓	✓	✓	✓	✓	✓	✓	✓	✓

End Panel Options

AUTH	CSFPE	EXBK	EXDN	FFD	FL/FR	FPE	INTGE	IPE
✓	✓	✓	✓	✓	✓	✓	✓	✓

Custom Modification Options

ADD_SHLF	ADDTK	ADRW	BVR	CBO	CCO	CFNTO	CFRMO	CLIP	CND	CSDGBK	EX	EX_OL	FALL	FBFL	FLUT ¹	FTK	ID	IH
✓	✓	✓	✓	✓	✓	✓	✓	✓	✓	✓	✓	✓	✓	✓	✓	✓	✓	✓

INVFRM	IW ²	LIGHT	MIP	OBRB	PFINBTMB	RD	RECTK	RH	ROSEFLUT	RT	RW	STW	TD	TKP	TVR	WS ³	WTR
✓	✓	✓	✓	✓	✓	✓	✓	✓	✓	✓	✓	✓	✓	✓	✓	✓	✓

¹ Not available with 6" fluting.

² Not available on 36" wide.

³ Not available on 24" wide.

Wall Transition Cabinets

WALL TRANSITION CABINET, 30", 33", 36", 39", 42", 45", or 48" HIGH

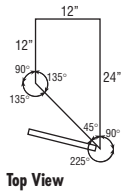
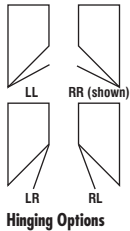
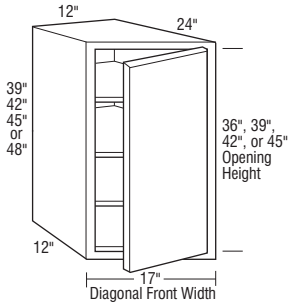
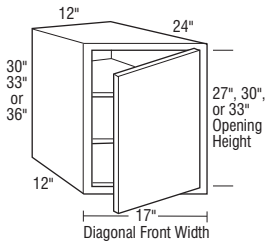

	Cubic Feet	1	2	3	4	5	6	7
WTC1 230LL	5.0	955	1004	1088	1172	1211	1251	1291
WTC1 230RR	5.0	955	1004	1088	1172	1211	1251	1291
WTC1 230LR	5.0	955	1004	1088	1172	1211	1251	1291
WTC1 230RL	5.0	955	1004	1088	1172	1211	1251	1291
WTC1 233LL	5.4	1074	1133	1218	1303	1344	1386	1428
WTC1 233RR	5.4	1074	1133	1218	1303	1344	1386	1428
WTC1 233LR	5.4	1074	1133	1218	1303	1344	1386	1428
WTC1 233RL	5.4	1074	1133	1218	1303	1344	1386	1428
WTC1 236LL	5.9	1207	1278	1364	1450	1492	1535	1578
WTC1 236RR	5.9	1207	1278	1364	1450	1492	1535	1578
WTC1 236LR	5.9	1207	1278	1364	1450	1492	1535	1578
WTC1 236RL	5.9	1207	1278	1364	1450	1492	1535	1578

• Two adjustable shelves.

WTC1 239LL	6.3	1357	1442	1527	1613	1656	1700	1744
WTC1 239RR	6.3	1357	1442	1527	1613	1656	1700	1744
WTC1 239LR	6.3	1357	1442	1527	1613	1656	1700	1744
WTC1 239RL	6.3	1357	1442	1527	1613	1656	1700	1744
WTC1 242LL	6.8	1520	1607	1691	1778	1819	1862	1905
WTC1 242RR	6.8	1520	1607	1691	1778	1819	1862	1905
WTC1 242LR	6.8	1520	1607	1691	1778	1819	1862	1905
WTC1 242RL	6.8	1520	1607	1691	1778	1819	1862	1905
WTC1 245LL	7.2	1684	1771	1856	1944	1984	2027	2070
WTC1 245RR	7.2	1684	1771	1856	1944	1984	2027	2070
WTC1 245LR	7.2	1684	1771	1856	1944	1984	2027	2070
WTC1 245RL	7.2	1684	1771	1856	1944	1984	2027	2070
WTC1 248LL	7.7	1849	1934	2020	2106	2150	2191	2232
WTC1 248RR	7.7	1849	1934	2020	2106	2150	2191	2232
WTC1 248LR	7.7	1849	1934	2020	2106	2150	2191	2232
WTC1 248RL	7.7	1849	1934	2020	2106	2150	2191	2232

• Three adjustable shelves.

Notes below apply to all products in section above:

- Authentic Ends, Flushed Ends, and FFD on End available on angled side only.
- Increased Depths available in 1/4" increments from 24 1/4" to 30".
- Reduced Depths available in 1/4" increments from 18" to 23 3/4".
- Not available on Inset and Beaded Inset styles.

Door & Drawer Options

AF	AOMD	CC	CG	GAMD	HC	IFHG	MC	MD	MFO	PRMD	SHMD	SPLITDR	SPLITDRWS	TCG	TCP
✓		✓	✓					✓	✓	✓	✓				

End Panel Options

AUTH ¹	CSFPE	EXBK	EXDN	FFD	FL/FR	FPE	INTGE	IPE
✓	✓	✓	✓	✓	✓	✓	✓	✓

Custom Modification Options

ADD	SHLF	ADTK	ADRW	BVR	CBO	CCO	CFNTD	CFRMO	CLIP	CND	CSDGBK	EX	EX_OL	F.ALL	FBFL	FLUT	FTK	ID	IH
✓				✓	✓	✓	✓	✓	✓	✓	✓	✓	✓	✓	✓	✓	✓	✓	✓

INVERM	IW	LIGHT	MIP	OBRB	PFINBTMB	RD	RECTK	RH ²	ROSFLUT	RT	RW	STW	TD	TKP	TVR	WS	WTR
			✓	✓	✓	✓	✓	✓								✓	✓

¹ Not available with authentic flush end both.

² Only available on 30" high.

IH/RH availability charts starting on page G•40.
IW/RW availability charts starting on page G•46.

STACKED WALL END CABINET DOUBLE DOOR, 36", 39", 42", 45", 48", 51", 54", 57", or 60" HIGH

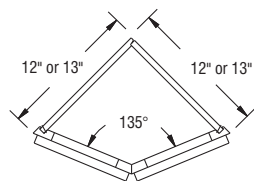
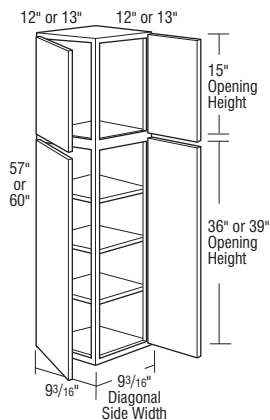
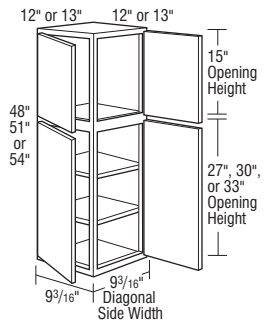
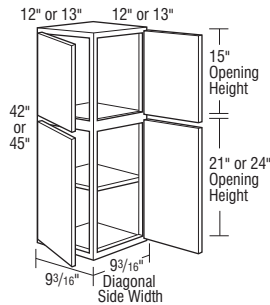
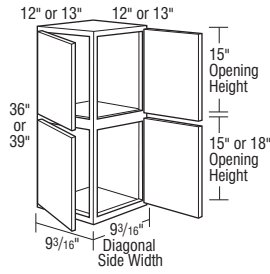

Top View

	Cubic Feet	1	2	3	4	5	6	7
STWEC1236D	4.5	1512	1589	1650	1737	1838	1994	2150
STWEC1239D	4.6	1645	1726	1794	1888	2000	2170	2340
• No shelves.								
STWEC1242D	4.9	1786	1877	1950	2053	2172	2357	2542
STWEC1245D	5.0	1942	2041	2120	2232	2362	2562	2762
• One adjustable shelf.								
STWEC1248D	5.3	2118	2206	2272	2387	2528	2738	2948
STWEC1251D	5.6	2347	2432	2501	2617	2758	2967	3176
STWEC1254D	6.0	2575	2661	2729	2845	2986	3196	3406
• Two adjustable shelves.								
STWEC1257D	6.3	2802	2890	2957	3072	3214	3425	3636
STWEC1260D	6.6	3031	3118	3185	3301	3442	3652	3862
• Three adjustable shelves.								

Notes below apply to all products in section above:

- Decorative Glass Door designs limited on this unit. See page H-18 for details.
- One 12" end/back may be ordered as Finished End. See page G-8 for details.
- Increased Heights modification will increase the height of the lower cabinet section. The upper section will retain its original height.
- Increased Depths available in 3" increments from 15" to 24".
- When ordering Inset or Beaded Inset styles, the doors must be hinged to the center face frame stiles.

Door & Drawer Options

AF	AOMD	CC	CG	GAMD	HC	IFHG	MC	MD	MFO	PRMD	SHMD	SPLITDR	SPLITDRWS	TCG	TCP
✓		✓				✓			✓		✓				

End Panel Options

AUTH	CSFPE	EXBK	EXDN ¹	FFD	FL/FR	FPE	INTGE	IPE
			✓		✓			

Custom Modification Options

ADD	SHLF	ADDTK	ADRW	BVR	CBO	CCO	CFNTO	CFRMO	CLIP	CND	CSDGBK	EX	EX_OL	FALL	FBFL	FLUT	FTK ²	ID	IH
✓				✓	✓	✓	✓	✓	✓	✓							✓	✓	✓
INVERM	IW	LIGHT ³	MIP	OBRB	PFINBTMB	RD	RECTK	RH	ROSFLUT	RT	RW	STW	TD	TKP	TVR	WS	WTR		
		✓	✓	✓	✓	✓	✓	✓	✓	✓	✓	✓	✓	✓	✓	✓	✓		

¹ Not available with EXDNLRB.
² Not available on FTKAV and style B-L.
³ Not available on 36"-45" high.

Wall End Cabinets

STACKED WALL END CABINET SINGLE DOOR, 36", 39", 42", 45", 48", 51", 54", 57", or 60" HIGH

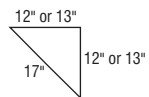
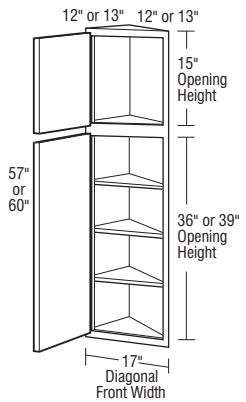
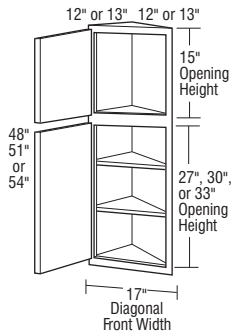
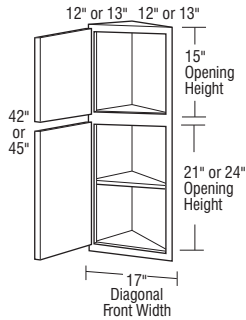
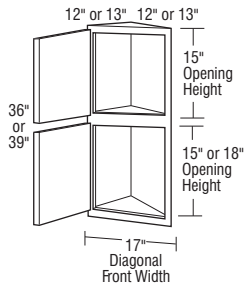

Top View

	Cubic Feet	1	2	3	4	5	6	7
STWEC1236 L or R	4.2	2545	2676	2777	2923	3091	3356	3621
STWEC1239 L or R	4.6	2609	2742	2845	2995	3170	3440	3710
• No shelves.								
STWEC1242 L or R	4.9	2674	2810	2916	3069	3248	3524	3800
STWEC1245 L or R	5.0	2740	2879	2988	3148	3330	3614	3898
• One adjustable shelf.								
STWEC1248 L or R	5.3	2922	2779	2635	2492	2421	2351	2281
STWEC1251 L or R	5.6	2993	2852	2709	2564	2492	2421	2350
STWEC1254 L or R	6.0	3064	2922	2779	2635	2564	2492	2420
• Two adjustable shelves.								
STWEC1257 L or R	6.3	3136	2993	2852	2709	2635	2564	2493
STWEC1260 L or R	6.6	3207	3064	2922	2779	2709	2635	2561
• Three adjustable shelves.								

Notes below apply to all products in section above:

- One 12" end/back may be ordered as Finished End. See page G•8 for details.
- Increased Heights modification will increase the height of the lower cabinet section. The upper section will retain its original height.
- Increased Depths available in 3" increments from 15" to 24".
- Only available in Inset and Beaded Inset when used in conjunction with a finial hinge.

Door & Drawer Options

AF	AOMD	CC	CG	GAMD	HC	IFHG	MC	MD	MFO	PRMD	SHMD	SPLITDR	SPLITDRWS	TCG	TCP
✓		✓	✓	✓	✓	✓	✓	✓	✓	✓	✓				

End Panel Options

AUTH	CSFPE	EXBK	EXDN ¹	FFD	FL/FR	FPE	INTGE	IPE
			✓		✓			

Custom Modification Options

ADD	SHLF	ADTK	ADRW	BVR	CBO	CCO	CFNTO	CFRMO	CLIP	CND	CSDGBK	EX	EX_OL	F.ALL	FBFL	FLUT	FTK	ID	IH	
✓				✓	✓	✓	✓	✓	✓	✓	✓							✓	✓	✓

INVRM	IW	LIGHT ²	MIP	OBRB	PFINBTMB	RD	RECTK	RH	ROSLUT	RT	RW	STW	TD	TKP	TVR	WS	WTR
		✓	✓	✓	✓							✓			✓	✓	✓

¹ Not available with EXDNLRB.

² Not available on 36"-45" high.

IH/RH availability charts starting on page G•40.
IW/RW availability charts starting on page G•46.

STACKED WALL TRANSITION CABINET, 36", 39", 42", 45", 48", 51", or 54" HIGH

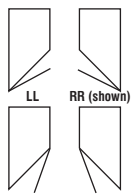
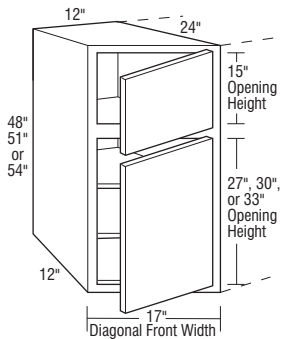
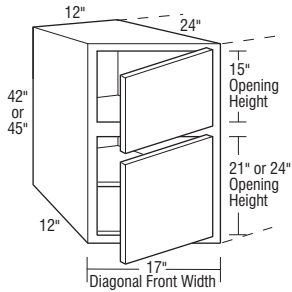
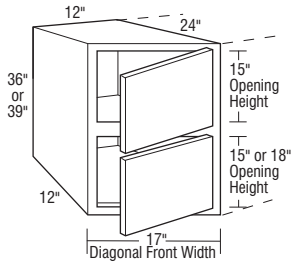

Hinging Options

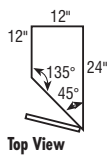

Top View

	Cubic Feet	1	2	3	4	5	6	7
STWTC1236LL	5.9	1589	1671	1735	1826	1933	2097	2261
STWTC1236RR	5.9	1589	1671	1735	1826	1933	2097	2261
STWTC1236LR	5.9	1589	1671	1735	1826	1933	2097	2261
STWTC1236RL	5.9	1589	1671	1735	1826	1933	2097	2261
STWTC1239LL	6.3	1641	1722	1787	1883	1993	2161	2329
STWTC1239RR	6.3	1641	1722	1787	1883	1993	2161	2329
STWTC1239LR	6.3	1641	1722	1787	1883	1993	2161	2329
STWTC1239RL	6.3	1641	1722	1787	1883	1993	2161	2329

• No shelves.

STWTC1242LL	6.8	1693	1779	1846	1945	2057	2232	2407
STWTC1242RR	6.8	1693	1779	1846	1945	2057	2232	2407
STWTC1242LR	6.8	1693	1779	1846	1945	2057	2232	2407
STWTC1242RL	6.8	1693	1779	1846	1945	2057	2232	2407
STWTC1245LL	7.2	1747	1835	1906	2006	2122	2304	2486
STWTC1245RR	7.2	1747	1835	1906	2006	2122	2304	2486
STWTC1245LR	7.2	1747	1835	1906	2006	2122	2304	2486
STWTC1245RL	7.2	1747	1835	1906	2006	2122	2304	2486

• One adjustable shelf.

STWTC1248LL	5.3	1758	1902	2046	2187	2260	2330	2400
STWTC1248RR	5.3	1758	1902	2046	2187	2260	2330	2400
STWTC1248LR	5.3	1758	1902	2046	2187	2260	2330	2400
STWTC1248RL	5.3	1758	1902	2046	2187	2260	2330	2400
STWTC1251LL	5.6	2022	2165	2309	2452	2523	2593	2663
STWTC1251RR	5.6	2022	2165	2309	2452	2523	2593	2663
STWTC1251LR	5.6	2022	2165	2309	2452	2523	2593	2663
STWTC1251RL	5.6	2022	2165	2309	2452	2523	2593	2663
STWTC1254LL	6.0	2132	2276	2419	2561	2631	2704	2777
STWTC1254RR	6.0	2132	2276	2419	2561	2631	2704	2777
STWTC1254LR	6.0	2132	2276	2419	2561	2631	2704	2777
STWTC1254RL	6.0	2132	2276	2419	2561	2631	2704	2777

• Two adjustable shelves.

Notes below apply to all products in section above:

- Authentic Ends, Flushed Ends, and FFD on End available on angled side only.
- Increased Depths available in 1/4" increments from 24 1/4" to 30".
- Reduced Depths available in 1/4" increments from 18" to 23 3/4".
- Increased Heights modification will increase the height of the lower cabinet section. The upper section will retain its original height.
- Not available on Inset and Beaded Inset styles.

Door & Drawer Options

AF	AOMD	CC	CG	GAMD	HC	IFHG	MC	MD	MFO	PRMD	SHMD	SPLITDR	SPLITDRWS	TCG	TCP
✓	✓	✓	✓	✓	✓	✓	✓	✓	✓	✓	✓	✓	✓	✓	✓

End Panel Options

AUTH ¹	CSFPE	EXBK	EXDN	FFD	FL/FR	FPE	INTGE	IPE
✓	✓	✓	✓	✓	✓	✓	✓	✓

Custom Modification Options

ADD_SHLF	ADDTK	ADRW	BVR	CBO	CCO	CFNT0	CFRMO	CLIP	CND	CSDGBK	EX	EX_OL	FALL	FBFL	FLUT	FTK	ID	IH
✓	✓	✓	✓	✓	✓	✓	✓	✓	✓	✓	✓	✓	✓	✓	✓	✓	✓	✓

INVRM	IW	LIGHT ²	MIP	OBRB	PFINBTMB	RD	RECTK	RH	ROSFLUT	RT	RW	STW	TD	TKP ²	TVR	WS	WTR
✓	✓	✓	✓	✓	✓	✓	✓	✓	✓	✓	✓	✓	✓	✓	✓	✓	✓

¹ Not available with authentic flush ends both.

² Not available on 36"-45" high.

Wall Transition Cabinets

STACKED WALL TRANSITION CABINET, 57" or 60" HIGH

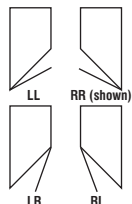
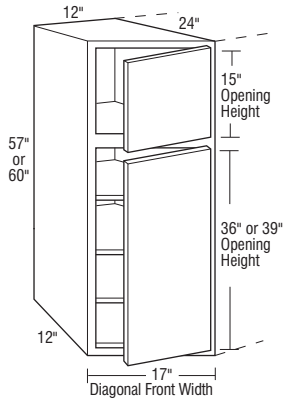

Hinging Options

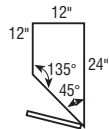

Top View

	Cubic Feet	1	2	3	4	5	6	7
STWTC1257LL	6.3	2262	2406	2548	2689	2762	2832	2902
STWTC1257RR	6.3	2262	2406	2548	2689	2762	2832	2902
STWTC1257LR	6.3	2262	2406	2548	2689	2762	2832	2902
STWTC1257RL	6.3	2262	2406	2548	2689	2762	2832	2902
STWTC1260LL	6.6	2336	2479	2622	2764	2834	2908	2982
STWTC1260RR	6.6	2336	2479	2622	2764	2834	2908	2982
STWTC1260LR	6.6	2336	2479	2622	2764	2834	2908	2982
STWTC1260RL	6.6	2336	2479	2622	2764	2834	2908	2982

- Three adjustable shelves.

Notes below apply to all products in section above:

- Authentic Ends, Flushed Ends, and FFD on End available on angled side only.
- Increased Depths available in 1/4" increments from 24 1/4" to 30".
- Reduced Depths available in 1/4" increments from 18" to 23 3/4".
- Increased Heights modification will increase the height of the lower cabinet section. The upper section will retain its original height.
- Not available on Inset and Beaded Inset styles.

Door & Drawer Options

AF	AOMD	CC	CG	GAMD	HC	IFHG	MC	MD	MFO	PRMD	SHMD	SPLITDR	SPLITDRWS	TCG	TCP
✓			✓	✓				✓	✓	✓	✓				

End Panel Options

AUTH ¹	CSFPE	EXBK	EXDN	FFD	FL/FR	FPE	INTGE	IPE
✓	✓	✓	✓	✓	✓	✓	✓	

Custom Modification Options

ADD_SHLF	ADDTK	ADRW	BVR	CBO	CCO	CFNTO	CFRMO	CLIP	CND	CSDGBK	EX	EX_OL	F.ALL	FBFL	FLUT	FTK	ID	IH	
✓	✓		✓	✓	✓	✓	✓	✓	✓	✓	✓						✓	✓	✓

INVFRM	IW	LIGHT	MIP	OBRB	PFINBTMB	RD	RECTK	RH	ROSFLUT	RT	RW	STW	TD	TKP	TVR	WS	WTR
	✓	✓	✓	✓	✓	✓	✓	✓				✓		✓			✓

¹ Not available with authentic flush ends both.

IH/RH availability charts starting on page G•40.
IW/RW availability charts starting on page G•46.

Wall Refrigerator Cabinets

WALL REFRIGERATOR, 18", 21", 24", or 27" HIGH, 24" DEEP

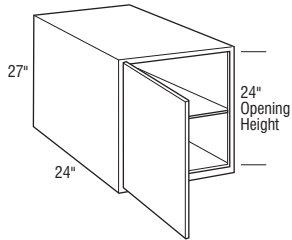
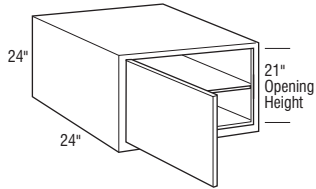
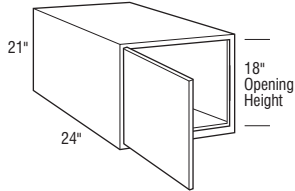
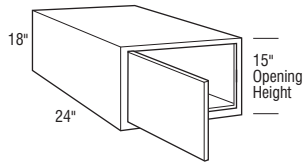

	Cubic Feet	1	2	3	4	5	6	7
W241824 L or R	7.3	1422	1496	1547	1628	1726	1886	2046
W242124 L or R	8.4	1449	1409	1468	1543	1612	1767	1922
W242424 L or R	9.5	1489	1568	1619	1705	1804	1971	2138
W242724 L or R	10.7	1594	1670	1723	1819	1890	2062	2234

• Includes one adjustable shelf.

• Includes one adjustable shelf.

Notes below apply to all products in section above:

- 24" deep cabinets must be fully supported by screws installed in a structural member in the ceiling or soffit, and into adjacent cabinets.
- Load limit is 15 lbs. per square foot of load bearing surface.
- Increased Depths available in 1/4" increments from 24 1/4" to 30".
- Reduced Depths available in 1/4" increments from 6" to 23 3/4".

Door & Drawer Options

AF	AOMD	CC	CG	GAMD	HC	IFHG	MC	MD	MFO	PRMD	SHMD	SPLITDR	SPLITDRWS	TCG	TCP
		✓				✓		✓	✓	✓					

End Panel Options

AUTH	CSFPE	EXBK	EXDN	FFD	FL/FR	FPE	INTGE	IPE
✓	✓	✓	✓	✓	✓	✓	✓	✓

Custom Modification Options

ADD_SHLF	ADDTK	ADRW	BVR	CBO	CCO	CFNTO	CFRMO	CLIP	CND	CSDGBK	EX	EX_OL	FALL	FBFL	FLUT ¹	FTK	ID	IH ²
	✓	✓	✓	✓	✓	✓	✓	✓	✓	✓	✓	✓	✓	✓	✓	✓	✓	✓

INVERM	IW	LIGHT	MIP	OBRB	PFINBTMB	RD	RECTK	RH	ROSLUT	RT	RW	STW	TD	TKP	TVR	WS	WTR
			✓	✓	✓	✓	✓	✓	✓	✓	✓	✓	✓	✓	✓	✓	✓

¹ Not available with 6" fluting.

² Not available on 27" high.

Wall Refrigerator Cabinets

WALL REFRIGERATOR, 12", 15", 18", 21", 24", or 27" HIGH, 24" DEEP

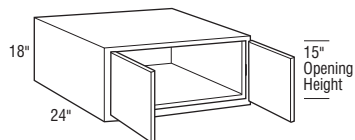
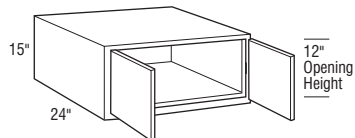
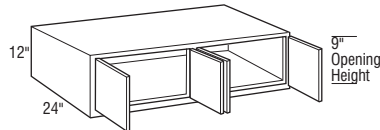
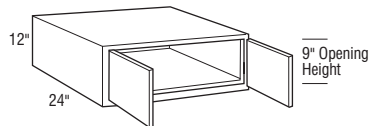

	Cubic Feet	1	2	3	4	5	6	7
W241224	5.0	1276	1336	1392	1462	1549	1695	1841
W271224	5.6	1316	1378	1436	1508	1598	1748	1898
W301224	6.5	1343	1406	1465	1539	1631	1784	1937
W331224	7.1	1393	1465	1519	1603	1690	1849	2008
W341224	7.0	1418	1492	1546	1632	1720	1881	2042
W361224	7.8	1442	1519	1572	1660	1749	1913	2077
W371224	7.6	1464	1538	1594	1682	1772	1935	2098
W391224	8.4	1485	1556	1615	1704	1794	1956	2118

W421224	8.6	1550	1628	1692	1782	1887	2057	2227
W451224	9.2	1583	1664	1730	1821	1933	2108	2283
W481224	10.2	1615	1700	1768	1860	1979	2158	2337

• Two sets of butt doors.

W241524	6.1	1395	1461	1518	1602	1665	1830	1995
W271524	6.9	1405	1472	1528	1613	1677	1842	2007
W301524	8.0	1409	1476	1533	1618	1682	1848	2014
W331524	8.7	1441	1512	1564	1651	1746	1907	2068
W341524	8.6	1471	1540	1596	1683	1776	1939	2102
W361524	9.5	1500	1568	1628	1715	1806	1970	2134
W371524	9.3	1520	1593	1648	1740	1831	2002	2173
W391524	10.2	1540	1618	1668	1765	1855	2033	2211

W241824	7.3	1426	1500	1552	1633	1731	1892	2053
W271824	8.1	1441	1515	1568	1649	1749	1912	2075
W301824	9.4	1470	1546	1600	1683	1785	1951	2117
W331824	10.3	1532	1609	1662	1749	1855	2029	2203
W341824	10.2	1562	1639	1694	1784	1890	2068	2246
W361824	11.2	1591	1668	1725	1818	1924	2106	2288
W371824	11.0	1600	1678	1736	1828	1937	2118	2299
W391824	12.1	1609	1687	1746	1838	1949	2129	2309

• One adjustable shelf.

Notes below apply to all products in section above:

- 24" deep cabinets must be fully supported by screws installed in a structural member in the ceiling or soffit, and into adjacent cabinets.
- Load limit is 15 lbs. per square foot of load bearing surface.
- Increased Depths available in 1/4" increments from 24 1/4" to 30".
- Reduced Depths available in 1/4" increments from 6" to 23 3/4".

Door & Drawer Options

AF	AQMD	CC	CG	GAMD ¹	HC	IFHG	MC	MD ¹	MFO	PRMD ²	SHMD	SPLITDR	SPLITDRWS	TCG	TCP
✓	✓	✓	✓	✓	✓	✓	✓	✓	✓	✓	✓	✓	✓	✓	✓

End Panel Options

AUTH	CSFPE	EXBK	EXDN	FFD	FL/FR	FPE	INTGE ²	IPE
✓	✓	✓	✓	✓	✓	✓	✓	✓

Custom Modification Options

ADD	SHLF	ADTK	ADRW	BVR	CBO	CCO	CFNTO	CFRMO	CLIP	CND	CSDGBK	EX	EX_OL	F.ALL	FBFL	FLUT ³	FTK	ID	IH ⁴
✓	✓	✓	✓	✓	✓	✓	✓	✓	✓	✓	✓	✓	✓	✓	✓	✓	✓	✓	✓

INVERM	IW ⁵	LIGHT	MIP	OBRB	PFINBTMB	RD	RECTK	RH	ROSFLUT	RT ⁶	RW	STW	TD	TKP	TVR	WS	WTR
✓	✓	✓	✓	✓	✓	✓	✓	✓	✓	✓	✓	✓	✓	✓	✓	✓	✓

¹ Not available on 12" high.

² Not available on 12" or 15" high.

³ Not available with 6" fluting.

⁴ Not available on 48" wide.

⁵ Not available on 39" or 48" wide.

⁶ Not available on 39" wide.

IH/RH availability charts starting on page G-40.
IW/RW availability charts starting on page G-46.

Wall Refrigerator Cabinets

WALL REFRIGERATOR, 12", 15", 18", 21", 24", or 27" HIGH, 24" DEEP (cont'd)

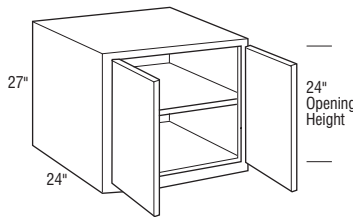
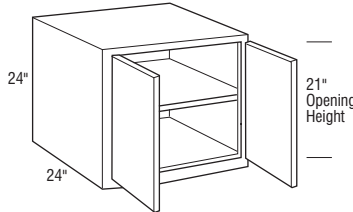
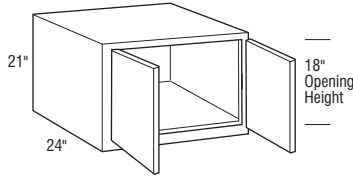

	Cubic Feet	1	2	3	4	5	6	7
W242124	8.4	1509	1468	1529	1607	1679	1841	2003
W272124	9.4	1525	1598	1665	1749	1829	2004	2179
W302124	10.9	1556	1631	1699	1785	1866	2045	2224
W332124	11.9	1586	1662	1723	1819	1935	2107	2279
W342124	11.7	1620	1697	1764	1859	1965	2146	2327
W362124	12.9	1653	1732	1805	1899	1994	2184	2374
W372124	12.8	1678	1756	1827	1923	2020	2210	2400
W392124	14.0	1703	1780	1849	1947	2045	2235	2425

W242424	9.5	1567	1650	1704	1795	1899	2075	2251
W272424	10.7	1583	1667	1722	1814	1919	2096	2273
W302424	12.3	1615	1701	1757	1851	1958	2139	2320
W332424	13.5	1674	1759	1819	1917	2031	2219	2407
W342424	13.3	1704	1791	1851	1950	2067	2258	2449
W362424	14.7	1733	1822	1882	1983	2102	2297	2492
W372424	14.5	1764	1852	1915	2016	2137	2335	2533
W392424	15.8	1794	1881	1947	2048	2172	2373	2574

• One adjustable shelf.

W242724	10.7	1678	1758	1814	1915	1989	2170	2351
W272724	12.0	1731	1814	1872	1976	2053	2240	2427
W302724	13.8	1785	1870	1930	2037	2116	2309	2502
W332724	15.1	1815	1901	1973	2075	2188	2387	2586
W342724	14.9	1854	1944	2013	2122	2228	2432	2636
W362724	16.4	1893	1986	2052	2169	2268	2476	2684
W372724	16.2	1936	2028	2097	2217	2320	2534	2748
W392724	17.7	1979	2070	2142	2265	2371	2591	2811

• One adjustable shelf.

Notes below apply to all products in section above:

- 24" deep cabinets must be fully supported by screws installed in a structural member in the ceiling or soffit, and into adjacent cabinets.
- Load limit is 15 lbs. per square foot of load bearing surface.
- Increased Depths available in 1/4" increments from 24 1/4" to 30".
- Reduced Depths available in 1/4" increments from 6" to 23 3/4".

Door & Drawer Options

AF	AOMD	CC	CG	GAJD	HC	IFHG	MC	MD	MFO	PRMD	SHMD	SPLITDR	SPLITDRWS	TCG	TCP
✓		✓	✓	✓		✓	✓	✓	✓	✓	✓	✓	✓		

End Panel Options

AUTH	CSFPE	EXBK	EXDN	FFD	FL/FR	FPE	INTGE	IPE
✓	✓	✓	✓	✓	✓	✓	✓	✓

Custom Modification Options

ADD_SHLF ¹	ADTK	ADRW	BVR	CBO	CCO	CFNTO	CFRMO	CLIP	CND	CSDGBK	EX	EX_OL	FALL	FBFL	FLUT ²	FTK	ID	IH ³
✓			✓	✓	✓	✓	✓	✓	✓	✓	✓	✓	✓	✓	✓	✓	✓	✓

INVERM	IW ⁴	LIGHT	MIP	OBRB	PFINBTMB	RD	RECTK	RH	ROSLUT	RT ⁵	RW	STW	TD	TKP	TVR	WS	WTR
✓	✓	✓	✓	✓	✓	✓			✓	✓			✓	✓	✓	✓	✓

¹ Only available on 24" and 27" high.

² Not available with 6" fluting.

³ Not available on 27" high.

⁴ Not available on 39" wide.

⁵ Not available on 39" wide.

Wall Refrigerator Cabinets

WALL REFRIGERATOR, 15", 18", 21", 24", or 27" HIGH, 24" DEEP

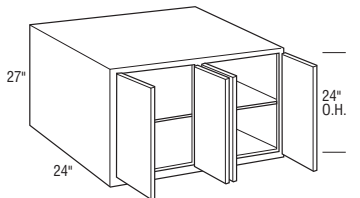
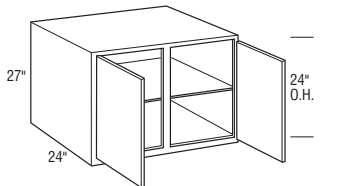
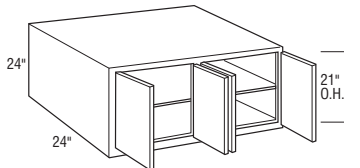
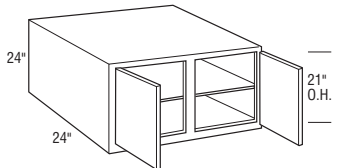
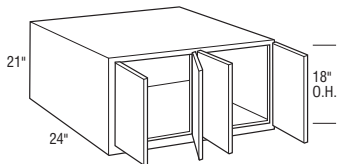
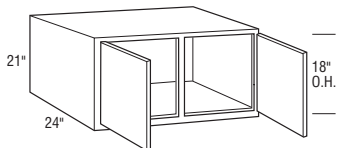
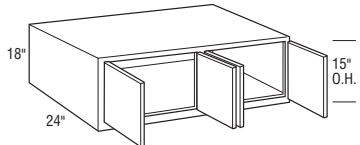
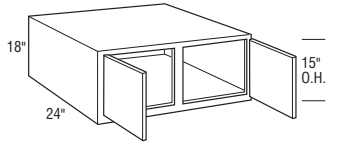
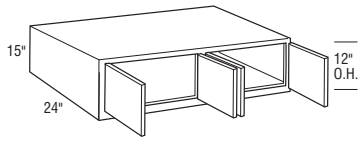

Cubic Feet	1	2	3	4	5	6	7	
W421524	10.5	1617	1699	1751	1853	1948	2135	2322
W451524	11.2	1649	1733	1786	1890	1987	2178	2369
W481524	12.0	1682	1768	1822	1928	2027	2222	2417

• Two sets of butt doors.

W421824	12.5	1722	1805	1868	1967	2085	2278	2471
W451824	13.3	1825	1913	1980	2085	2210	2415	2620
W481824CS	14.2	1916	2009	2079	2189	2321	2536	2751

W481824	14.2	2108	2210	2287	2408	2553	2790	3027
----------------	------	------	------	------	------	------	------	------

• Two sets of butt doors.

W422124	14.4	1839	1922	1997	2103	2209	2414	2619
W452124	15.4	1949	2037	2117	2229	2342	2559	2776
W482124CS	16.4	2066	2159	2244	2363	2483	2713	2943

W482124	16.4	2293	2396	2491	2623	2756	3011	3266
----------------	------	------	------	------	------	------	------	------

• Two sets of butt doors.

W422424	16.4	1920	2013	2083	2191	2324	2539	2754
W452424	17.5	2016	2114	2187	2301	2440	2666	2892
W482424CS	18.7	2117	2220	2296	2416	2562	2799	3036

• Includes one adjustable shelf.

W482424	18.7	2308	2420	2503	2633	2793	3051	3309
----------------	------	------	------	------	------	------	------	------

• Two sets of butt doors.
• Includes one adjustable shelf.

W422724	18.3	2157	2256	2335	2469	2584	2824	3064
----------------	------	------	------	------	------	------	------	------

W452724	19.6	2265	2369	2452	2592	2713	2965	3217
----------------	------	------	------	------	------	------	------	------

W482724CS	20.9	2378	2487	2575	2722	2849	3113	3377
------------------	------	------	------	------	------	------	------	------

• Includes one adjustable shelf.

W482724	20.9	2592	2711	2807	2967	3105	3393	3681
----------------	------	------	------	------	------	------	------	------

• Two sets of butt doors.
• Includes one adjustable shelf.

Notes below apply to all products in section above:

- 24" deep cabinets must be fully supported by screws installed in a structural member in the ceiling or soffit, and into adjacent cabinets.
- Load limit is 15 lbs. per square foot of load bearing surface.
- Increased Depths available in 1/4" increments from 24 1/4" to 30".
- Reduced Depths available in 1/4" increments from 6" to 23 3/4".

Door & Drawer Options

AF	AOMD	CC	CG	GAMD	HC	IFHG	MC	MD	MFO	PRMD ¹	SHMD	SPLITDR	SPLITDRWS	TCG	TCP
✓	✓	✓	✓	✓	✓	✓	✓	✓	✓	✓	✓	✓	✓	✓	✓

End Panel Options

AUTH	CSFPE	EXBK	EXDN	FFD	FL/FR	FPE	INTGE ¹	IPE
✓	✓	✓	✓	✓	✓	✓	✓	✓

Custom Modification Options

ADD	SHLF ²	ADDTK	ADRW	BVR	CBO	CCO	CFNTO	CFRMO	CLIP	CND	CSDGBK	EX	EX_OL	FALL	FBFL	FLUT ³	FTK	ID	IH ⁴
✓	✓	✓	✓	✓	✓	✓	✓	✓	✓	✓	✓	✓	✓	✓	✓	✓	✓	✓	✓

INVERM	IW ⁵	LIGHT	MIP	OBRB	PFINBTMB	RD	RECTK	RH	ROSLUT	RT ⁶	RW	STW	TD	TKP	TVR	WS	WTR
✓	✓	✓	✓	✓	✓	✓	✓	✓	✓	✓	✓	✓	✓	✓	✓	✓	✓

¹ Not available on 15" high.

² Only available on 24" and 27" high.

³ Not available with 6" fluting.

⁴ Not available on 27" high.

⁵ Not available on 48" wide.

⁶ Not available on 39" wide.

IH/RH availability charts starting on page G-40.
IW/RW availability charts starting on page G-46.

WALL REFRIGERATOR PULL-OUT CABINET, 18", 21", or 24" HIGH, 24" DEEP L G I X

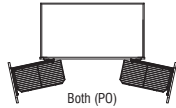
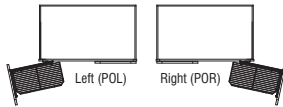
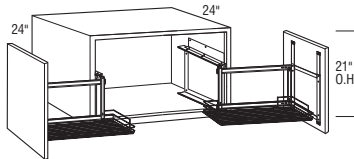
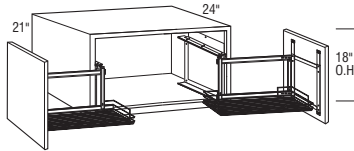
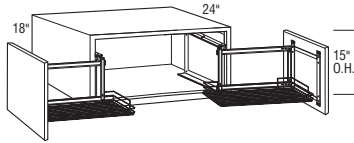

Top View

	Cubic Feet	1	2	3	4	5	6	7
W361824PO L or R	11.3	3040	3117	3174	3267	3373	3555	3737
W371824PO L or R	11.6	3040	3117	3174	3267	3373	3555	3737
W391824PO L or R	12.2	3058	3136	3195	3287	3398	3578	3758
W361824PO	11.3	4489	4566	4623	4716	4822	5004	5186
W371824PO	11.6	4507	4585	4644	4736	4847	5027	5207
W391824PO	12.2	4507	4585	4644	4736	4847	5027	5207

W362124PO L or R	13.0	3102	3181	3254	3348	3443	3633	3823
W372124PO L or R	13.3	3102	3181	3254	3348	3443	3633	3823
W392124PO L or R	14.0	3152	3229	3298	3396	3494	3684	3874
W362124PO	13.0	4551	4630	4703	4797	4892	5082	5272
W372124PO	13.3	4601	4678	4747	4845	4943	5133	5323
W392124PO	14.0	4601	4678	4747	4845	4943	5133	5323

W362424PO L or R	14.7	3182	3271	3331	3432	3551	3746	3941
W372424PO L or R	15.1	3182	3271	3331	3432	3551	3746	3941
W392424PO L or R	15.9	3243	3330	3396	3497	3621	3822	4023
W362424PO	14.7	4631	4720	4780	4881	5000	5195	5390
W372424PO	15.1	4692	4779	4845	4946	5070	5271	5472
W392424PO	15.9	4692	4779	4845	4946	5070	5271	5472

- Door mounted pull-out with a chrome wire rack that extends fully to the front of the cabinet then opens to the side for easy accessibility to contents.
- Designed for use above refrigerator or other high applications.
- Smart Stop feature not available on pull-out.
- Available installed in either the left side, right side or both sides.
- For sufficient pull-out clearance, 13 1/8" of adjacent space is required for door to open fully when installed near a wall or corner.
- Chrome rack is 10" wide and 20 13/16" deep.
- 24" deep cabinets must be fully supported by screws installed in a structural member in the ceiling or soffit, and into adjacent cabinets.
- Load limit is 15 lbs. per square foot of load bearing surface.
- Not available on Inset and Beaded Inset styles.

Door & Drawer Options

AF	AOMD	CC	CG	GAMD	HC	IFHG	MC	MD	MFO	PRMD	SHMD	SPLITDR	SPLITDRWS	TCG	TCP
									✓						

End Panel Options

AUTH	CSFPE	EXBK	EXDN	FFD	FL/FR	FPE	INTGE	IPE
✓	✓	✓	✓	✓	✓	✓	✓	✓

Custom Modification Options

ADD_SHLF	ADDTK	ADRW	BVR	CBO	CCO	CFNTO	CFRMO	CLIP	CND	CSDGBK	EX	EX_OL	F.ALL	FBFL	FLUT	FTK	ID	IH ¹
	✓	✓	✓							✓	✓	✓			✓	✓	✓	✓

INVFRM	IW	LIGHT	MIP	OBRB	PFINBTMB	RD	RECTK	RH	ROSEFLUT ²	RT	RW	STW	TD	TKP	TVR	WS	WTR
	✓		✓	✓			✓		✓					✓			✓

¹ Not available on 24" high.

² Not available with 6" fluting.

Wall Open Cabinets

WALL OPEN CABINET with PLAIN BACK, 30", 33", 36", 39", or 42" HIGH

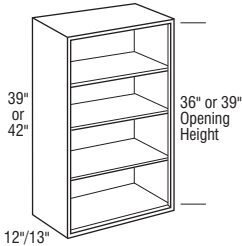
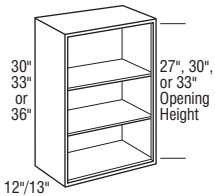

	Cubic Feet	1	2	3	4	5	6	7
WOCP2430	6.7	1273	1333	1378	1448	1546	1681	1816
WOCP3030	8.3	1472	1544	1600	1682	1777	1949	2121
WOCP3630	9.9	1574	1654	1714	1814	1901	2074	2247
WOCP2433	7.4	1528	1599	1653	1738	1853	2016	2179
WOCP3033	9.1	1764	1851	1921	2020	2129	2341	2553
WOCP3633	10.9	1890	1986	2057	2175	2283	2486	2689
WOCP2436	8.0	1619	1698	1749	1846	1964	2141	2318
WOCP3036	9.9	1928	2020	2096	2205	2332	2548	2764
WOCP3636	11.8	2071	2174	2255	2378	2499	2736	2973

WOCP2439	8.7	1732	1817	1870	1976	2101	2293	2485
WOCP3039	10.7	2066	2164	2241	2361	2498	2727	2956
WOCP3639	12.7	2216	2325	2413	2538	2674	2928	3182
WOCP2442	9.3	1775	1864	1923	2027	2154	2349	2544
WOCP3042	11.5	2160	2264	2346	2475	2606	2843	3080
WOCP3642	13.7	2324	2435	2517	2663	2809	3072	3335

- 30"/33"/36" high includes two adjustable shelves, and 39"/42" high includes three adjustable shelves.
- If ordered with Hewn Technique, will not feature sand-through characteristics.
- To change the top rail valance, specify one of the Top Valance Rail modifications.
- Straight Valance is standard on Beaded Inset styles.
- Minimum cabinet width with Arch Valance is 15".
- Inset and Beaded Inset Door Styles are a standard 13" deep.
- Full Overlay Styles:
 - Increased Depths available in 1/4" increments from 12 1/4" to 30".
 - Reduced Depths available in 1/4" increments from 6" to 11 3/4".
- Inset and Beaded Inset Styles:
 - Increased Depths available in 1/4" increments from 13 1/4" to 30".
 - Reduced Depths available in 1/4" increments from 6" to 12 3/4".

Door & Drawer Options

AF	AOMD	CC	CG	GAMD	HC	IFHG	MC	MD	MFO	PRMD	SHMD	SPLITDR	SPLITDRWS	TCG	TCP
----	------	----	----	------	----	------	----	----	-----	------	------	---------	-----------	-----	-----

End Panel Options

AUTH	CSFPE	EXBK	EXDN	FFD	FL/FR	FPE	INTGE	IPE
✓	✓	✓	✓	✓	✓	✓	✓	✓

Custom Modification Options

ADD	SHLF	ADDTK	ADRW	BVR	CBO	CCO	CFNTO	CFRMO	CLIP ¹	CND	CSDGBK	EX	EX_OL	FALL	FBFL	FLUT ²	FTK	ID ³	IH
✓	✓	✓	✓	✓	✓	✓	✓	✓	✓	✓	✓	✓	✓	✓	✓	✓	✓	✓	✓

INVFRM	IW	LIGHT	MIP	OBRB	PFINBTMB	RD ³	RECTK	RH	ROSFLUT	RT ⁴	RW	STW	TD ⁵	TKP	TVR	WS ¹	WTR
✓	✓	✓	✓	✓	✓	✓	✓	✓	✓	✓	✓	✓	✓	✓	✓	✓	✓

¹ Not available on 24" wide.

² Not available with 6" fluting.

³ Not available on WOCP2433 and WOCP2436.

⁴ Not available on 39" wide.

⁵ Not available on 33"/42" high.

IH/RH availability charts starting on page G•40.
IW/RW availability charts starting on page G•46.

WALL OPEN CABINET with CAR SIDING BACK, 30", 33", 36", 39", or 42" HIGH

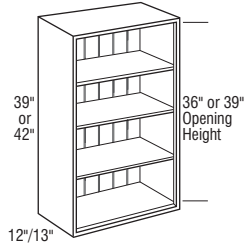
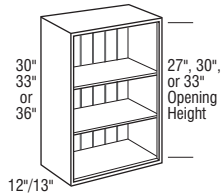

	Cubic Feet	1	2	3	4	5	6	7
WOCB2430	6.7	1553	1613	1658	1728	1826	1961	2096
WOCB3030	8.3	1752	1824	1880	1962	2057	2229	2401
WOCB3630	9.9	1854	1934	1994	2094	2181	2354	2527
WOCB2433	7.4	1808	1879	1933	2018	2133	2296	2459
WOCB3033	9.1	2044	2131	2201	2300	2409	2621	2833
WOCB3633	10.9	2170	2266	2337	2455	2563	2766	2969
WOCB2436	8.0	1899	1978	2029	2126	2244	2421	2598
WOCB3036	9.9	2208	2300	2376	2485	2612	2828	3044
WOCB3636	11.8	2351	2454	2535	2658	2779	3016	3253

WOCB2439	8.7	2012	2097	2150	2256	2381	2573	2765
WOCB3039	10.7	2346	2444	2521	2641	2778	3007	3236
WOCB3639	12.7	2496	2605	2693	2818	2954	3208	3462
WOCB2442	9.3	2055	2144	2203	2307	2434	2629	2824
WOCB3042	11.5	2440	2544	2626	2755	2886	3123	3360
WOCB3642	13.7	2604	2715	2797	2943	3089	3352	3615

- 30"/33"/36" high includes two adjustable shelves, and 39"/42" high includes three adjustable shelves.
- If ordered with Hewn Technique, will not feature sand-through characteristics.
- To change the top rail valance, specify one of the Top Valance Rail modifications.
- Straight Valance is standard on Beaded Inset styles.
- Minimum cabinet width with Arch Valance is 15".
- Inset and Beaded Inset Door Styles are a standard 13" deep.
- Full Overlay Styles:
 - Increased Depths available in 1/4" increments from 12 1/4" to 30".
 - Reduced Depths available in 1/4" increments from 6" to 11 3/4".
- Inset and Beaded Inset Styles:
 - Increased Depths available in 1/4" increments from 13 1/4" to 30".
 - Reduced Depths available in 1/4" increments from 6" to 12 3/4".

Door & Drawer Options

AF	AOMD	CC	CG	GAMD	HC	IFHG	MC	MD	MFO	PRMD	SHMD	SPLITDR	SPLITDRWS	TCG	TCB
----	------	----	----	------	----	------	----	----	-----	------	------	---------	-----------	-----	-----

End Panel Options

AUTH	CSFPE	EXBK	EXDN	FFD	FL/FR	FPE	INTGE	IPE
✓	✓	✓	✓	✓	✓	✓	✓	✓

Custom Modification Options

ADD_SHLF	ADDTK	ADRW	BVR	CBO	CCO	CFNTO	CFRMO	CLIP ¹	CND	CSDGBK	EX	EX_OL	FALL	FBFL	FLUT ²	FTK	ID ³	IH
✓	✓	✓	✓	✓	✓	✓	✓	✓	✓	✓	✓	✓	✓	✓	✓	✓	✓	✓

INVERM	IW	LIGHT	MIP	OBRB	PFINBTMB	RD ⁴	RECTK	RH	ROSFLUT	RT ⁴	RW	STW	TD ⁵	TKP	TVR	WS ¹	WTR
✓	✓	✓	✓	✓	✓	✓	✓	✓	✓	✓	✓	✓	✓	✓	✓	✓	✓

¹ Not available on 24" wide.

² Not available with 6" fluting.

³ Not available on WOCB2433 and WOCB2436.

⁴ Not available on 39" wide.

⁵ Not available on 33"-42" high.

Wall Corner Cabinets

WALL CORNER SINGLE DOOR, 24" HIGH

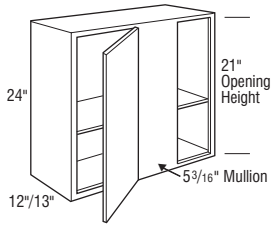

	Cubic Feet	1	2	3	4	5	6	7
WC2424 L or R	5.5	1025	1070	1110	1164	1218	1322	1426
WC2724 L or R	6.1	1079	1126	1164	1222	1286	1391	1496
WC3024 L or R	6.7	1144	1190	1226	1295	1356	1474	1592

- Door will be hinged on same side as blind section unless specified otherwise.
- L or R denotes blind.
- One adjustable shelf.
- Can be pulled 3".
- When ordering cabinet in a full overlay door style, unit must be pulled at least 1 1/2" to 3" from wall.
- Includes one 3" filler, shipped unattached.
- Inset and Beaded Inset Door Styles are a standard 13" deep.
- Full Overlay Styles:
 - Increased Depths available in 1/4" increments from 12 1/4" to 30".
 - Reduced Depths available in 1/4" increments from 6" to 11 3/4".
- Inset and Beaded Inset Styles:
 - Increased Depths available in 1/4" increments from 13 1/4" to 30".
 - Reduced Depths available in 1/4" increments from 6" to 12 3/4".

Door & Drawer Options

AF	AOMD	CC	CG	GAMD	HC	IFHG	MC	MD	MFO	PRMD ¹	SHMD	SPLITDR	SPLITDRWS	TCG	TCP
			✓				✓	✓	✓	✓					

End Panel Options

AUTH	CSFPE	EXBK	EXDN	FFD	FL/FR	FPE	INTGE	IPE
✓	✓	✓	✓	✓	✓	✓	✓	✓

Custom Modification Options

ADD_SHLF	ADDTK	ADRW	BVR	CBO	CCO	CFNTD	CFRMO	CLIP ¹	CND	CSDGBK	EX	EX_OL	FALL	FBFL	FLUT ²	FTK	ID	IH	
	✓		✓	✓	✓	✓	✓	✓	✓	✓	✓	✓	✓	✓	✓	✓	✓	✓	✓
INVFRM	IW	LIGHT	MIP	OBRB	PFINBTMB	RD	RECTK	RH	ROSLUT	RT	RW	STW	TD	TKP	TVR	WS	WTR		
	✓		✓	✓	✓	✓	✓	✓	✓					✓	✓	✓	✓	✓	

¹ Not available on 24" wide.

² Not available with 6" fluting.

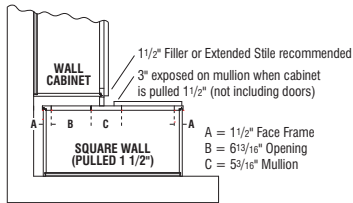

Top View
Full Overlay Styles

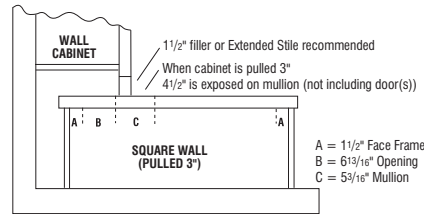

Top View
Full Overlay Styles, Pulled 3"

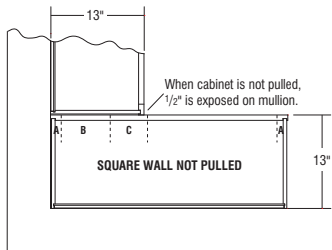

Top View
Inset Styles

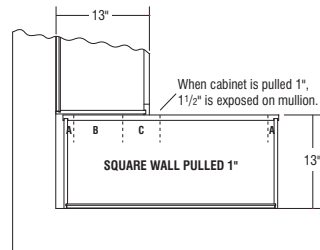

Top View
Inset Styles, Pulled 1"

IH/RH availability charts starting on page G•40.
IW/RW availability charts starting on page G•46.

NEW WALL CORNER SINGLE DOOR,
27" HIGH

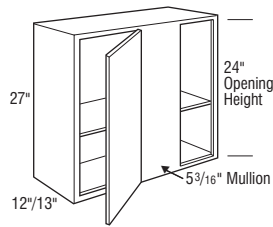

Cubic Feet	1	2	3	4	5	6	7	
WC2427 L or R	6.1	1025	1070	1110	1164	1218	1322	1426
WC2727 L or R	6.9	1079	1126	1164	1222	1286	1391	1496
WC3027 L or R	7.6	1144	1190	1226	1295	1356	1474	1592

- Door will be hinged on same side as blind section unless specified otherwise.
- L or R denotes blind.
- One adjustable shelf.
- Can be pulled 3".
- When ordering cabinet in a full overlay door style, unit must be pulled at least 1 1/2" to 3" from wall.
- Includes one 3" filler, shipped unattached.
- Inset and Beaded Inset Door Styles are a standard 13" deep.
- Full Overlay Styles:
 - Increased Depths available in 1/4" increments from 12 1/4" to 30".
 - Reduced Depths available in 1/4" increments from 6" to 11 3/4".
- Inset and Beaded Inset Styles:
 - Increased Depths available in 1/4" increments from 13 1/4" to 30".
 - Reduced Depths available in 1/4" increments from 6" to 12 3/4".

Door & Drawer Options

AF	AOMD	CC	CG	GAMD	HC	IFHG	MC	MD	MFO	PRMD ¹	SHMD	SPLITDR	SPLITDRWS	TCG	TCP
✓	✓	✓	✓	✓	✓	✓	✓	✓	✓	✓	✓	✓	✓	✓	✓

End Panel Options

AUTH	CSFPE	EXBK	EXDN	FFD	FL/FR	FPE	INTGE	IPE
✓	✓	✓	✓	✓	✓	✓	✓	✓

Custom Modification Options

ADD	SHLF	ADDTK	ADRW	BVR	CBO	CCO	CFNTD	CFRMO	CLIP ¹	CND	CSDGBK	EX	EX_OL	FALL	FBFL	FLUT ²	FTK	ID	IH	
✓	✓	✓	✓	✓	✓	✓	✓	✓	✓	✓	✓	✓	✓	✓	✓	✓	✓	✓	✓	✓

INVERM	IW	LIGHT	MIP	OBRB	PFINBTMB	RD	RECTK	RH	ROSLUT	RT	RW	STW	TD	TKP	TVR	WS	WTR
✓	✓	✓	✓	✓	✓	✓	✓	✓	✓	✓	✓	✓	✓	✓	✓	✓	✓

¹ Not available on 24" wide.

² Not available with 6" fluting.

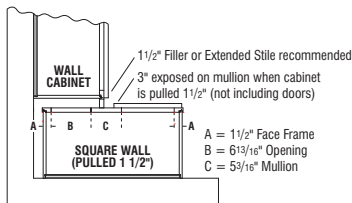

**Top View
Full Overlay Styles**

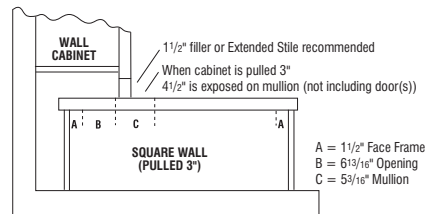

**Top View
Full Overlay Styles, Pulled 3"**

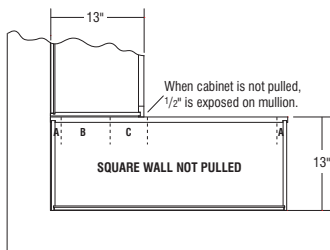

**Top View
Inset Styles**

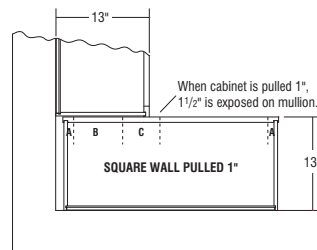

**Top View
Inset Styles, Pulled 1"**

Wall Corner Cabinets

WALL CORNER SINGLE DOOR, 30" HIGH

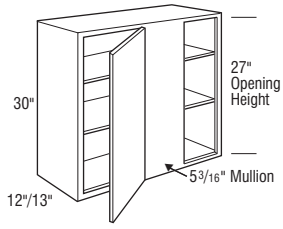

	Cubic Feet	1	2	3	4	5	6	7
WC2430 L or R	6.7	1025	1070	1110	1164	1218	1322	1426
WC2730 L or R	7.5	1079	1126	1164	1222	1286	1391	1496
WC3030 L or R	8.3	1144	1190	1226	1295	1356	1474	1592
WC3330 L or R	9.1	1182	1234	1278	1340	1410	1538	1666
WC3630 L or R	9.9	1257	1322	1363	1436	1507	1636	1765

- Door will be hinged on same side as blind section unless specified otherwise.
- L or R denotes blind.
- Two adjustable shelves.
- Can be pulled 3".
- When ordering cabinet in a full overlay door style, unit must be pulled at least 1 1/2" to 3" from wall.
- Includes one 3" filler, shipped unattached.
- Inset and Beaded Inset Door Styles are a standard 13" deep.
- Full Overlay Styles:
 - Increased Depths available in 1/4" increments from 12 1/4" to 30".
 - Reduced Depths available in 1/4" increments from 6" to 11 3/4".
- Inset and Beaded Inset Styles:
 - Increased Depths available in 1/4" increments from 13 1/4" to 30".
 - Reduced Depths available in 1/4" increments from 6" to 12 3/4".

Door & Drawer Options

AF	AO	MD	CC	CG	GAMD	HC	IFHG	MC	MD	MFO	PRMD ¹	SHMD	SPLITDR	SPLITDRWS	TCG	TCP
✓	✓	✓	✓	✓	✓	✓	✓	✓	✓	✓	✓	✓	✓	✓	✓	✓

End Panel Options

AUTH	CSFPE	EXBK	EXDN	FFD	FL/FR	FPE	INTGE	IPE
✓	✓	✓	✓	✓	✓	✓	✓	✓

Custom Modification Options

ADD	SHLF	ADTK	ADRW	BVR	CBO	CCO	CFNTD	CFRMO	CLIP ²	CND	CSDGBK	EX	EX_OL	FALL	FBFL	FLUT ³	FTK	ID	IH
✓	✓	✓	✓	✓	✓	✓	✓	✓	✓	✓	✓	✓	✓	✓	✓	✓	✓	✓	✓

INVFRM	IW	LIGHT	MIP	OBRB	PFINBTMB	RD	RECTK	RH	ROSFLUT	RT	RW	STW	TD	TKP	TVR	WS	WTR
✓	✓	✓	✓	✓	✓	✓	✓	✓	✓	✓	✓	✓	✓	✓	✓	✓	✓

¹ Not available on 24" wide.

² Not available on 24" wide, with clipped left.

³ Not available with 6" fluting.

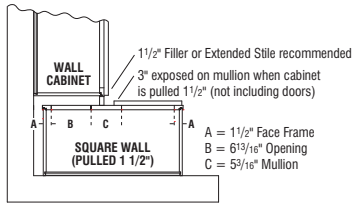

Top View
Full Overlay Styles

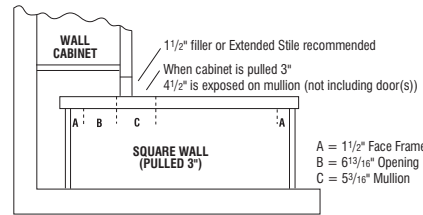

Top View
Full Overlay Styles, Pulled 3"

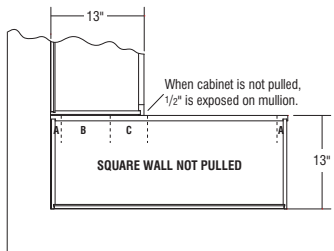

Top View
Inset Styles

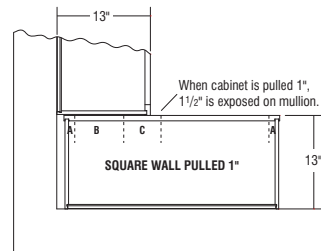

Top View
Inset Styles, Pulled 1"

IH/RH availability charts starting on page G•40.
IW/RW availability charts starting on page G•46.

WALL CORNER DOUBLE DOOR, 30" HIGH

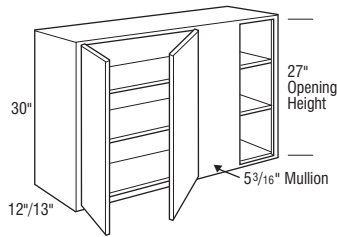

Cubic Feet	1	2	3	4	5	6	7	
WC3930 L or R	10.7	1664	1739	1806	1892	1989	2166	2343
WC4230 L or R	11.5	1757	1833	1896	1994	2083	2263	2443
WC4530 L or R	12.3	1810	1887	1949	2052	2153	2343	2533
WC4830 L or R	13.1	1833	1918	1982	2091	2195	2383	2571

- L or R denotes blind.
- Two adjustable shelves.
- Can be pulled 3".
- When ordering cabinet in a full overlay door style, unit must be pulled at least 1 1/2" to 3" from wall.
- Includes one 3" filler, shipped unattached.
- Inset and Beaded Inset Door Styles are a standard 13" deep.
- Full Overlay Styles:
 - Increased Depths available in 1/4" increments from 12 1/4" to 30".
 - Reduced Depths available in 1/4" increments from 6" to 11 3/4".
- Inset and Beaded Inset Styles:
 - Increased Depths available in 1/4" increments from 13 1/4" to 30".
 - Reduced Depths available in 1/4" increments from 6" to 12 3/4".

Door & Drawer Options

AF	AOMD	CC	CG	GAMD	HC	IFHG	MC	MD	MFO	PRMD	SHMD	SPLITDR ¹	SPLITDRWS	TCG	TCP
✓	✓	✓	✓	✓	✓	✓	✓	✓	✓	✓	✓	✓	✓	✓	✓

End Panel Options

AUTH	CSFPE	EXBK	EXDN	FFD	FL/FR	FPE	INTGE	IPE
✓	✓	✓	✓	✓	✓	✓	✓	✓

Custom Modification Options

ADD	SHLF	ADDTK	ADRW	BVR	CBO	CCO	CFNTD	CFRMO	CLIP ²	CND	CSDGBK	EX	EX_OL	FALL	FBFL	FLUT ³	FTK	ID	IH	
✓	✓	✓	✓	✓	✓	✓	✓	✓	✓	✓	✓	✓	✓	✓	✓	✓	✓	✓	✓	✓
INVERM	IW	LIGHT	MIP	OBRB	PFINBTMB	RD	RECTK	RH	ROSLUT	RT	RW	STW	TD	TKP	TVR	WS	WTR			
✓	✓	✓	✓	✓	✓	✓	✓	✓	✓	✓	✓	✓	✓	✓	✓	✓	✓			

¹ Not available on 39" or 42" wide.

² Not available with clipped left.

³ Not available with 6" fluting.

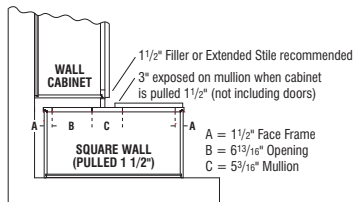

Top View
Full Overlay Styles

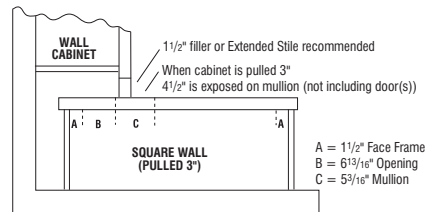

Top View
Full Overlay Styles, Pulled 3"

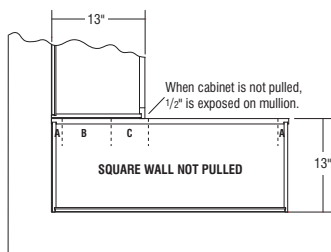

Top View
Inset Styles

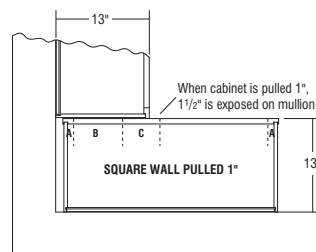

Top View
Inset Styles, Pulled 1"

Wall Corner Cabinets

WALL CORNER SINGLE DOOR, 33" HIGH

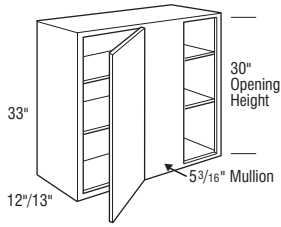

	Cubic Feet	1	2	3	4	5	6	7
WC2433 L or R	7.4	1303	1356	1409	1481	1551	1685	1819
WC2733 L or R	8.3	1370	1431	1481	1557	1640	1775	1910
WC3033 L or R	9.1	1454	1514	1564	1647	1731	1883	2035
WC3333 L or R	10.0	1507	1571	1631	1710	1798	1962	2126
WC3633 L or R	10.9	1605	1685	1739	1832	1925	2093	2261

- Door will be hinged on same side as blind section unless specified otherwise.
- L or R denotes blind.
- Two adjustable shelves.
- Can be pulled 3".
- When ordering cabinet in a full overlay door style, unit must be pulled at least 1 1/2" to 3" from wall.
- Includes one 3" filler, shipped unattached.
- Inset and Beaded Inset Door Styles are a standard 13" deep.
- Full Overlay Styles:
 - Increased Depths available in 1/4" increments from 12 1/4" to 30".
 - Reduced Depths available in 1/4" increments from 6" to 11 3/4".
- Inset and Beaded Inset Styles:
 - Increased Depths available in 1/4" increments from 13 1/4" to 30".
 - Reduced Depths available in 1/4" increments from 6" to 12 3/4".

Door & Drawer Options

AF	AO	MD	CC	CG	GAMD	HC	IFHG	MC	MD	MFO	PRMD ¹	SHMD	SPLITDR	SPLITDRWS	TCG	TCP
✓	✓	✓	✓	✓	✓	✓	✓	✓	✓	✓	✓	✓				

End Panel Options

AUTH	CSFPE	EXBK	EXDN	FFD	FL/FR	FPE	INTGE	IPE
✓	✓	✓	✓	✓	✓	✓	✓	✓

Custom Modification Options

ADD	SHLF	ADTK	ADRW	BVR	CBO	CCO	CFNTD	CFRMO	CLIP ²	CND	CSDGBK	EX	EX_OL	FALL	FBFL	FLUT ³	FTK	ID	IH	
✓	✓	✓	✓	✓	✓	✓	✓	✓	✓	✓	✓	✓	✓	✓	✓	✓	✓	✓	✓	✓

INVFRM	IW	LIGHT	MIP	OBRB	PFINBTMB	RD	RECTK	RH	ROSLUT	RT	RW	STW	TD	TKP	TVR	WS	WTR
	✓	✓	✓	✓	✓	✓	✓	✓	✓	✓	✓	✓	✓	✓	✓	✓	✓

¹ Not available for 24" wide.
² Not available on 24" wide, with clipped left.
³ Not available with 6" fluting.

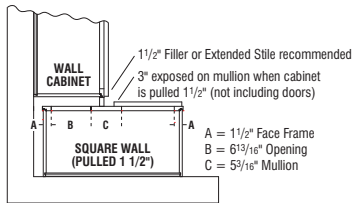

Top View
Full Overlay Styles

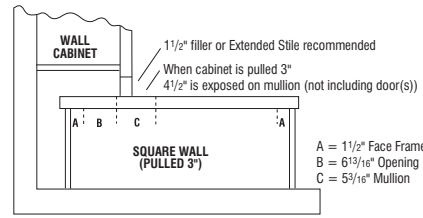

Top View
Full Overlay Styles, Pulled 3"

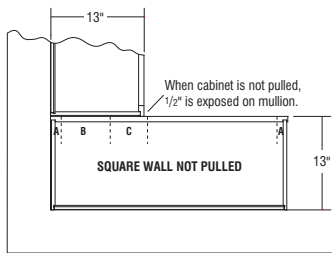

Top View
Inset Styles

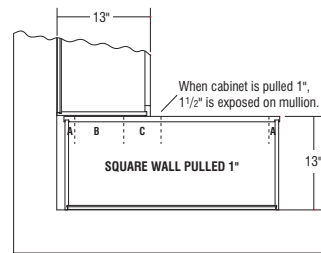

Top View
Inset Styles, Pulled 1"

IH/RH availability charts starting on page G•40.
 IW/RW availability charts starting on page G•46.

WALL CORNER DOUBLE DOOR, 33" HIGH

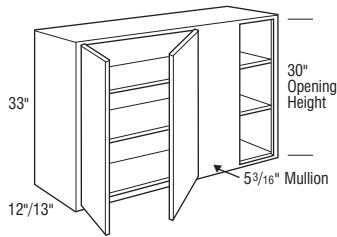

Cubic Feet	1	2	3	4	5	6	7
WC3933 L or R	11.7	2133	2230	2313	2427	2558	3008
WC4233 L or R	12.6	2245	2352	2432	2561	2674	3142
WC4533 L or R	13.5	2316	2421	2496	2633	2764	3258
WC4833 L or R	14.3	2352	2465	2544	2684	2820	3316

- L or R denotes blind.
- Two adjustable shelves.
- Can be pulled 3".
- When ordering cabinet in a full overlay door style, unit must be pulled at least 1 1/2" to 3" from wall.
- Includes one 3" filler, shipped unattached.
- Inset and Beaded Inset Door Styles are a standard 13" deep.
- Full Overlay Styles:
 - Increased Depths available in 1/4" increments from 12 1/4" to 30".
 - Reduced Depths available in 1/4" increments from 6" to 11 3/4".
- Inset and Beaded Inset Styles:
 - Increased Depths available in 1/4" increments from 13 1/4" to 30".
 - Reduced Depths available in 1/4" increments from 6" to 12 3/4".

Door & Drawer Options

AF	AOMD	CC	CG	GAMD	HC	IFHG	MC	MD	MFO	PRMD	SHMD	SPLITDR ¹	SPLITDRWS	TCG	TCP
✓	✓	✓	✓	✓	✓	✓	✓	✓	✓	✓	✓	✓	✓	✓	✓

End Panel Options

AUTH	CSFPE	EXBK	EXDN	FFD	FL/FR	FPE	INTGE	IPE
✓	✓	✓	✓	✓	✓	✓	✓	✓

Custom Modification Options

ADD	SHLF	ADDTK	ADRW	BVR	CBO	CCO	CFNTD	CFRMO	CLIP ²	CND	CSDGBK	EX	EX_OL	FALL	FBFL	FLUT ³	FTK	ID	IH	
✓	✓	✓	✓	✓	✓	✓	✓	✓	✓	✓	✓	✓	✓	✓	✓	✓	✓	✓	✓	✓
INVERM	IW	LIGHT	MIP	OBRB	PFINBTMB	RD	RECTK	RH	ROSLUT	RT	RW	STW	TD	TKP	TVR	WS	WTR			
✓	✓	✓	✓	✓	✓	✓	✓	✓	✓	✓	✓	✓	✓	✓	✓	✓	✓	✓	✓	

¹ Not available on 39" or 42" wide.

² Not available with clipped left.

³ Not available with 6" fluting.

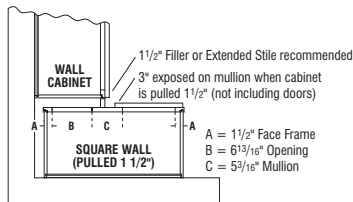

Top View
Full Overlay Styles

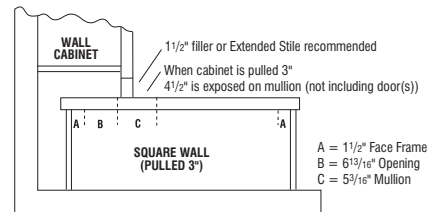

Top View
Full Overlay Styles, Pulled 3"

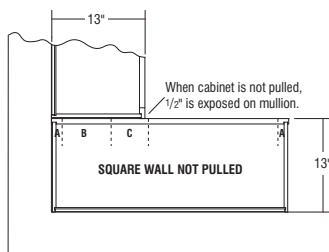

Top View
Inset Styles

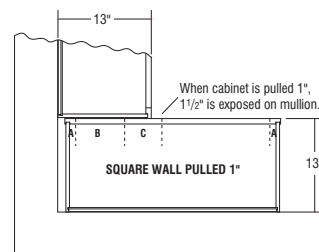

Top View
Inset Styles, Pulled 1"

Wall Corner Cabinets

WALL CORNER SINGLE DOOR, 36" HIGH

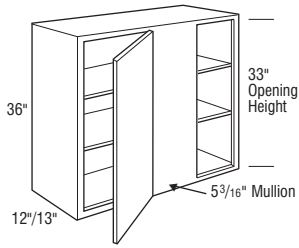

	Cubic Feet	1	2	3	4	5	6	7
WC2436 L or R	8.0	1476	1546	1604	1683	1719	1867	2015
WC2736 L or R	9.0	1555	1626	1679	1763	1797	1956	2115
WC3036 L or R	9.9	1592	1667	1725	1817	1908	2068	2228
WC3336 L or R	10.9	1663	1738	1797	1887	1979	2158	2337
WC3636 L or R	11.8	1757	1833	1896	1994	2095	2279	2463

- Door will be hinged on same side as blind section unless specified otherwise.
- L or R denotes blind.
- Two adjustable shelves.
- Can be pulled 3".
- When ordering cabinet in a full overlay door style, unit must be pulled at least 1 1/2" to 3" from wall.
- Includes one 3" filler, shipped unattached.
- Inset and Beaded Inset Door Styles are a standard 13" deep.
- Full Overlay Styles:
 - Increased Depths available in 1/4" increments from 12 1/4" to 30".
 - Reduced Depths available in 1/4" increments from 6" to 11 3/4".
- Inset and Beaded Inset Styles:
 - Increased Depths available in 1/4" increments from 13 1/4" to 30".
 - Reduced Depths available in 1/4" increments from 6" to 12 3/4".

Door & Drawer Options

AF	AOMD	CC	CG	GAMD	HC	IFHG	MC	MD	MFO	PRMD	SHMD	SPLITDR	SPLITDRWS	TCG	TCP
✓	✓	✓	✓	✓	✓	✓	✓	✓	✓	✓	✓			✓	✓

End Panel Options

AUTH	CSFPE	EXBK	EXDN	FFD	FL/FR	FPE	INTGE	IPE
✓	✓	✓	✓	✓	✓	✓	✓	✓

Custom Modification Options

ADD	SHLF	ADTK	ADRW	BVR	CBO	CCO	CFNTD	CFRMO	CLIP ¹	CND	CSDGBK	EX	EX_OL	FALL	FBFL	FLUT ²	FTK	ID	IH	
✓	✓	✓	✓	✓	✓	✓	✓	✓	✓	✓	✓	✓	✓	✓	✓	✓	✓	✓	✓	✓

INVFRM	IW	LIGHT	MIP	OBRB	PFINBTMB	RD	RECTK	RH	ROSFLUT	RT	RW	STW	TD	TKP	TVR	WS	WTR
	✓	✓	✓	✓	✓	✓	✓	✓	✓	✓	✓	✓	✓	✓	✓	✓	✓

¹ Not available on 24" wide, with clipped left.

² Not available with 6" fluting.

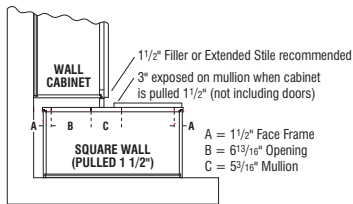

Top View
Full Overlay Styles

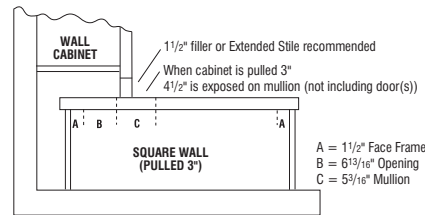

Top View
Full Overlay Styles, Pulled 3"

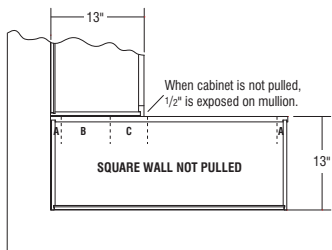

Top View
Inset Styles

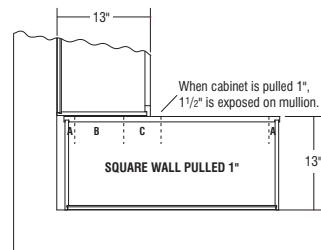

Top View
Inset Styles, Pulled 1"

IH/RH availability charts starting on page G•40.
IW/RW availability charts starting on page G•46.

WALL CORNER DOUBLE DOOR, 36" HIGH

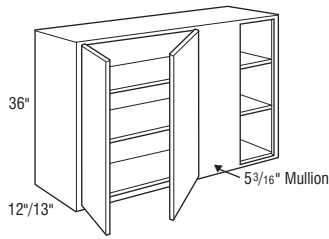

Cubic Feet	1	2	3	4	5	6	7
WC3936 L or R	12.7	2234	2335	2416	2539	2684	3162
WC4236 L or R	13.7	2362	2471	2555	2685	2839	3347
WC4536 L or R	14.6	2495	2614	2700	2842	3003	3541
WC4836 L or R	15.6	2639	2763	2858	3004	3175	3743

- L or R denotes blind.
- Two adjustable shelves.
- Can be pulled 3".
- When ordering cabinet in a full overlay door style, unit must be pulled at least 1 1/2" to 3" from wall.
- Includes one 3" filler, shipped unattached.
- Inset and Beaded Inset Door Styles are a standard 13" deep.
- Full Overlay Styles:
 - Increased Depths available in 1/4" increments from 12 1/4" to 30".
 - Reduced Depths available in 1/4" increments from 6" to 11 3/4".
- Inset and Beaded Inset Styles:
 - Increased Depths available in 1/4" increments from 13 1/4" to 30".
 - Reduced Depths available in 1/4" increments from 6" to 12 3/4".

Door & Drawer Options

AF	AOMD	CC	CG	GAMD	HC	IFHG	MC	MD	MFO	PRMD	SHMD	SPLITDR ¹	SPLITDRWS	TCG	TCP
✓	✓	✓	✓	✓	✓	✓	✓	✓	✓	✓	✓	✓	✓	✓	✓

End Panel Options

AUTH	CSFPE	EXBK	EXDN	FFD	FL/FR	FPE	INTGE	IPE
✓	✓	✓	✓	✓	✓	✓	✓	✓

Custom Modification Options

ADD	SHLF	ADDTK	ADRW	BVR	CBO	CCO	CFNTD	CFRMO	CLIP ²	CND	CSDGBK	EX	EX_OL	FALL	FBFL	FLUT ³	FTK	ID	IH	
✓	✓	✓	✓	✓	✓	✓	✓	✓	✓	✓	✓	✓	✓	✓	✓	✓	✓	✓	✓	✓
INVERM	IW	LIGHT	MIP	OBRB	PFINBTMB	RD	RECTK	RH	ROSLUT	RT	RW	STW	TD	TKP	TVR	WS	WTR			
✓	✓	✓	✓	✓	✓	✓	✓	✓	✓	✓	✓	✓	✓	✓	✓	✓	✓	✓	✓	✓

¹ Not available on 39" or 42" wide.

² Not available with clipped left.

³ Not available with 6" fluting.

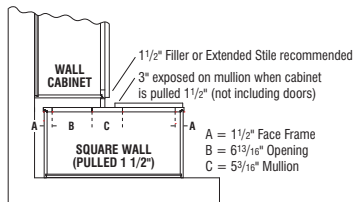

Top View
Full Overlay Styles

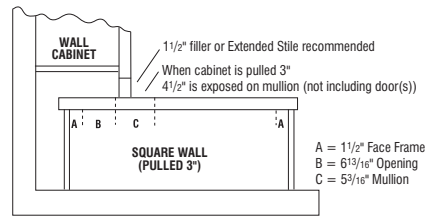

Top View
Full Overlay Styles, Pulled 3"

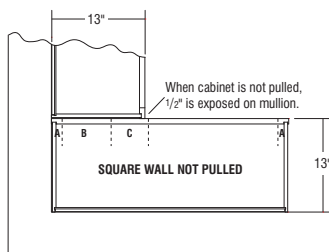

Top View
Inset Styles

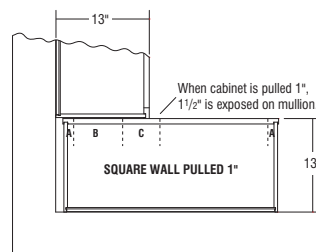

Top View
Inset Styles, Pulled 1"

Wall Corner Cabinets

WALL CORNER SINGLE DOOR, 39" HIGH

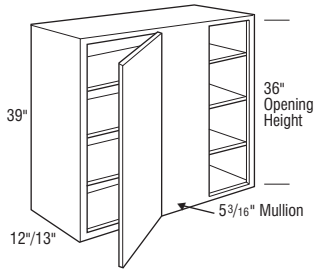

	Cubic Feet	1	2	3	4	5	6	7
WC2439 L or R	8.7	1751	1832	1903	1999	2042	2218	2394
WC2739 L or R	9.7	1843	1929	1994	2094	2138	2325	2512
WC3039 L or R	10.7	1887	1978	2051	2155	2266	2465	2664
WC3339 L or R	11.7	1973	2063	2138	2243	2353	2569	2785
WC3639 L or R	12.7	2086	2180	2256	2373	2492	2714	2936

- Door will be hinged on same side as blind section unless specified otherwise.
- L or R denotes blind.
- Three adjustable shelves.
- Can be pulled 3".
- When ordering cabinet in a full overlay door style, unit must be pulled at least 1 1/2" to 3" from wall.
- Includes one 3" filler, shipped unattached.
- Inset and Beaded Inset Door Styles are a standard 13" deep.
- Full Overlay Styles:
 - Increased Depths available in 1/4" increments from 12 1/4" to 30".
 - Reduced Depths available in 1/4" increments from 6" to 11 3/4".
- Inset and Beaded Inset Styles:
 - Increased Depths available in 1/4" increments from 13 1/4" to 30".
 - Reduced Depths available in 1/4" increments from 6" to 12 3/4".

Door & Drawer Options

AF	AOMD	CC	CG	GAMD	HC	IFHG	MC	MD	MFO	PRMD ¹	SHMD	SPLITDR	SPLITDRWS	TCG	TCP
✓	✓	✓	✓	✓	✓	✓	✓	✓	✓	✓	✓			✓	✓

End Panel Options

AUTH	CSFPE	EXBK	EXDN	FFD	FL/FR	FPE	INTGE	IPE
✓	✓	✓	✓	✓	✓	✓	✓	✓

Custom Modification Options

ADD_SHLF	ADTK	ADRW	BVR	CBO	CCO	CFNTD	CFRMO	CLIP ²	CND	CSDGBK	EX	EX_OL	FALL	FBFL	FLUT ³	FTK	ID	IH	
✓	✓	✓	✓	✓	✓	✓	✓	✓	✓	✓	✓	✓	✓	✓	✓	✓	✓	✓	✓

INVFRM	IW	LIGHT	MIP	OBRB	PFINBTMB	RD	RECTK	RH	ROSFLUT	RT	RW	STW	TD	TKP	TVR	WS	WTR
	✓	✓	✓	✓	✓	✓	✓	✓	✓	✓	✓	✓	✓	✓	✓	✓	✓

¹ Not available on 24" wide.

² Not available on 24" wide, with clipped left.

³ Not available with 6" fluting.

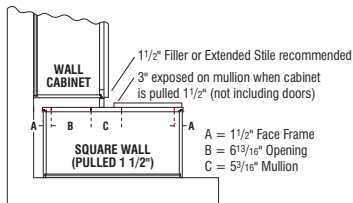

Top View
Full Overlay Styles

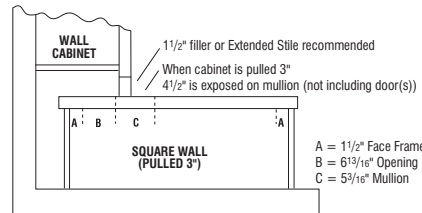

Top View
Full Overlay Styles, Pulled 3"

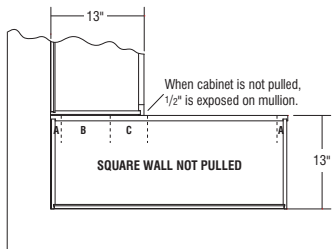

Top View
Inset Styles

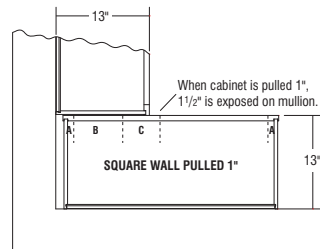

Top View
Inset Styles, Pulled 1"

IH/RH availability charts starting on page G•40.
IW/RW availability charts starting on page G•46.

WALL CORNER DOUBLE DOOR, 39" HIGH

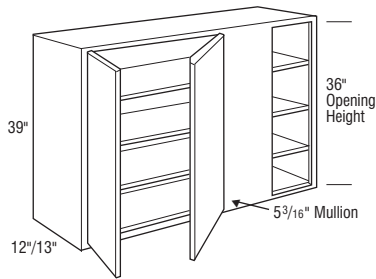

Cubic Feet	1	2	3	4	5	6	7
WC3939 L or R	13.8	2302	2411	2489	2620	2768	3262
WC4239 L or R	14.8	2436	2546	2631	2769	2928	3452
WC4539 L or R	15.8	2575	2692	2784	2929	3099	3649
WC4839 L or R	16.8	2722	2849	2946	3100	3278	3860

- L or R denotes blind.
- Three adjustable shelves.
- Can be pulled 3".
- When ordering cabinet in a full overlay door style, unit must be pulled at least 1 1/2" to 3" from wall.
- Includes one 3" filler, shipped unattached.
- Inset and Beaded Inset Door Styles are a standard 13" deep.
- Full Overlay Styles:
 - Increased Depths available in 1/4" increments from 12 1/4" to 30".
 - Reduced Depths available in 1/4" increments from 6" to 11 3/4".
- Inset and Beaded Inset Styles:
 - Increased Depths available in 1/4" increments from 13 1/4" to 30".
 - Reduced Depths available in 1/4" increments from 6" to 12 3/4".

Door & Drawer Options

AF	AOMD	CC	CG	GAMD	HC	IFHG	MC	MD	MFO	PRMD	SHMD	SPLITDR ¹	SPLITDRWS	TCG	TCP
✓	✓	✓	✓	✓	✓	✓	✓	✓	✓	✓	✓	✓	✓	✓	✓

End Panel Options

AUTH	CSFPE	EXBK	EXDN	FFD	FL/FR	FPE	INTGE	IPE
✓	✓	✓	✓	✓	✓	✓	✓	✓

Custom Modification Options

ADD	SHLF	ADDTK	ADRW	BVR	CBO	CCO	CFNTD	CFRMO	CLIP ²	CND	CSDGBK	EX	EX_OL	FALL	FBFL	FLUT ³	FTK	ID	IH
✓	✓	✓	✓	✓	✓	✓	✓	✓	✓	✓	✓	✓	✓	✓	✓	✓	✓	✓	✓
INVFRM	IW	LIGHT	MIP	OBRB	PFINBTMB	RD	RECTK	RH	ROSLUT	RT	RW	STW	TD	TKP	TVR	WS	WTR		
✓	✓	✓	✓	✓	✓	✓	✓	✓	✓	✓	✓	✓	✓	✓	✓	✓	✓		

¹ Not available on 39" or 42" wide.

² Not available with clipped left.

³ Not available with 6" fluting.

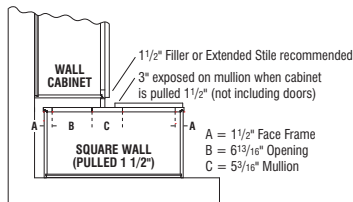

Top View
Full Overlay Styles

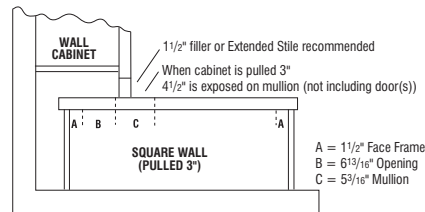

Top View
Full Overlay Styles, Pulled 3"

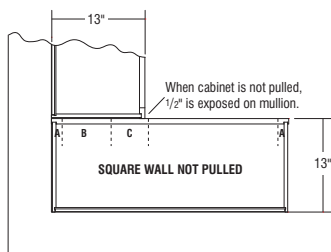

Top View
Inset Styles

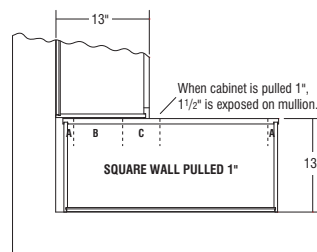

Top View
Inset Styles, Pulled 1"

Wall Corner Cabinets

WALL CORNER SINGLE DOOR, 42" HIGH

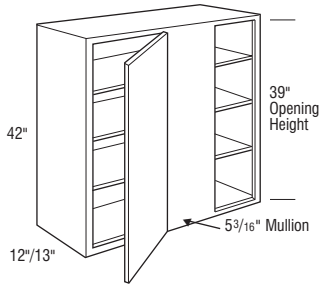

	Cubic Feet	1	2	3	4	5	6	7
WC2442 L or R	9.3	1929	2020	2084	2193	2195	2383	2571
WC2742 L or R	10.4	2025	2120	2197	2309	2302	2505	2708
WC3042 L or R	11.5	2041	2136	2295	2417	2430	2641	2852
WC3342 L or R	12.6	2120	2218	2380	2511	2530	2759	2988
WC3642 L or R	13.7	2233	2334	2417	2539	2655	2896	3137

- Door will be hinged on same side as blind section unless specified otherwise.
- L or R denotes blind.
- Three adjustable shelves.
- Can be pulled 3".
- When ordering cabinet in a full overlay door style, unit must be pulled at least 1 1/2" to 3" from wall.
- Includes one 3" filler, shipped unattached.
- Inset and Beaded Inset Door Styles are a standard 13" deep.
- Full Overlay Styles:
 - Increased Depths available in 1/4" increments from 12 1/4" to 30".
 - Reduced Depths available in 1/4" increments from 6" to 11 3/4".
- Inset and Beaded Inset Styles:
 - Increased Depths available in 1/4" increments from 13 1/4" to 30".
 - Reduced Depths available in 1/4" increments from 6" to 12 3/4".

Door & Drawer Options

AF	AOMD	CC	CG	GAMD	HC	IFHG	MC	MD	MFO	PRMD ¹	SHMD	SPLITDR	SPLITDRWS	TCG	TCP
✓	✓	✓	✓	✓	✓	✓	✓	✓	✓	✓	✓	✓	✓	✓	✓

End Panel Options

AUTH	CSFPE	EXBK	EXDN	FFD	FL/FR	FPE	INTGE	IPE
✓	✓	✓	✓	✓	✓	✓	✓	✓

Custom Modification Options

ADD	SHLF	ADTK	ADRW	BVR	CBO	CCO	CFNTD	CFRMO	CLIP ²	CND	CSDGBK	EX	EX_OL	FALL	FBFL	FLUT ³	FTK	ID	IH	
✓	✓	✓	✓	✓	✓	✓	✓	✓	✓	✓	✓	✓	✓	✓	✓	✓	✓	✓	✓	✓

INVFRM	IW	LIGHT	MIP	OBRB	PFINBTMB	RD	RECTK	RH	ROSFLUT	RT	RW	STW	TD	TKP	TVR	WS	WTR
✓	✓	✓	✓	✓	✓	✓	✓	✓	✓	✓	✓	✓	✓	✓	✓	✓	✓

¹ Not available on 24" wide.

² Not available on 24" wide, with clipped left.

³ Not available with 6" fluting.

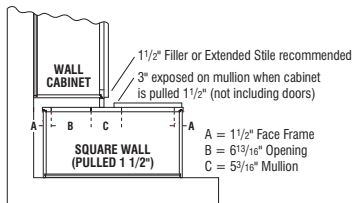

Top View
Full Overlay Styles

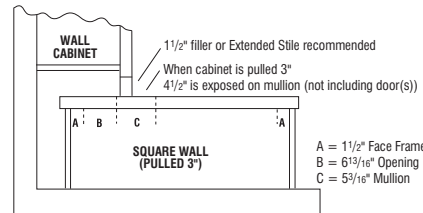

Top View
Full Overlay Styles, Pulled 3"

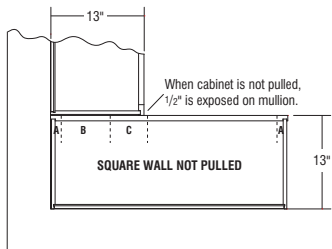

Top View
Inset Styles

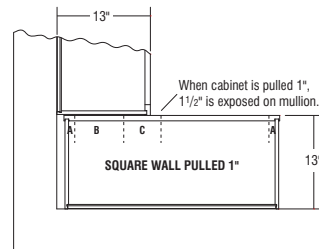

Top View
Inset Styles, Pulled 1"

IH/RH availability charts starting on page G•40.
IW/RW availability charts starting on page G•46.

WALL CORNER DOUBLE DOOR, 42" HIGH

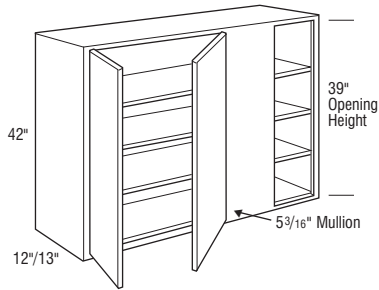

Cubic Feet	1	2	3	4	5	6	7
WC3942 L or R	14.8	2478	2588	2678	2817	2968	3506
WC4242 L or R	15.9	2721	2845	2946	3098	3261	3835
WC4542 L or R	17.0	2802	2933	3029	3189	3350	3958
WC4842 L or R	18.1	2848	2973	3084	3246	3417	4035

- L or R denotes blind.
- Three adjustable shelves.
- Can be pulled 3".
- When ordering cabinet in a full overlay door style, unit must be pulled at least 1 1/2" to 3" from wall.
- Includes one 3" filler, shipped unattached.
- Inset and Beaded Inset Door Styles are a standard 13" deep.
- Full Overlay Styles:
 - Increased Depths available in 1/4" increments from 12 1/4" to 30".
 - Reduced Depths available in 1/4" increments from 6" to 11 3/4".
- Inset and Beaded Inset Styles:
 - Increased Depths available in 1/4" increments from 13 1/4" to 30".
 - Reduced Depths available in 1/4" increments from 6" to 12 3/4".

Door & Drawer Options

AF	AOMD	CC	CG	GAMD	HC	IFHG	MC	MD	MFO	PRMD	SHMD	SPLITDR ¹	SPLITDRWS	TCG	TCP
✓	✓	✓	✓	✓	✓	✓	✓	✓	✓	✓	✓	✓	✓	✓	✓

End Panel Options

AUTH	CSFPE	EXBK	EXDN	FFD	FL/FR	FPE	INTGE	IPE
✓	✓	✓	✓	✓	✓	✓	✓	✓

Custom Modification Options

ADD	SHLF	ADDTK	ADRW	BVR	CBO	CCO	CFNTD	CFRMO	CLIP ²	CND	CSDGBK	EX	EX_OL	FALL	FBFL	FLUT ³	FTK	ID	IH	
✓	✓	✓	✓	✓	✓	✓	✓	✓	✓	✓	✓	✓	✓	✓	✓	✓	✓	✓	✓	✓
INVERM	IW	LIGHT	MIP	OBRB	PFINBTMB	RD	RECTK	RH	ROSLUT	RT	RW	STW	TD	TKP	TVR	WS	WTR			
✓	✓	✓	✓	✓	✓	✓	✓	✓	✓	✓	✓	✓	✓	✓	✓	✓	✓	✓	✓	✓

¹ Not available on 39" or 42" wide.

² Not available with clipped left.

³ Not available with 6" fluting.

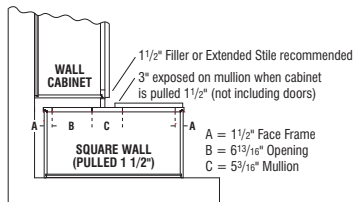

Top View
Full Overlay Styles

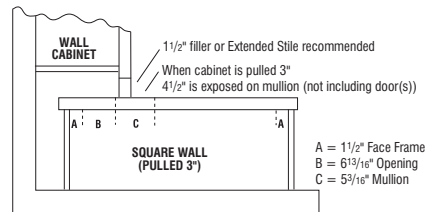

Top View
Full Overlay Styles, Pulled 3"

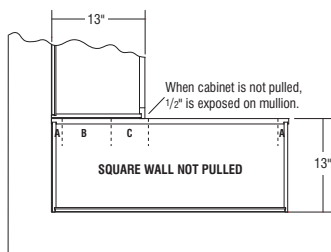

Top View
Inset Styles

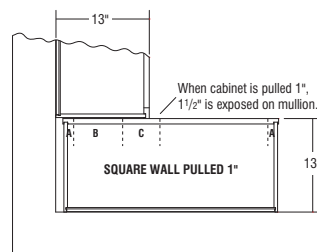

Top View
Inset Styles, Pulled 1"

Wall Corner Cabinets

EASY REACH WALL CORNER, 30", 33", 36", 39", or 42" HIGH

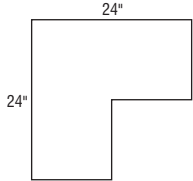
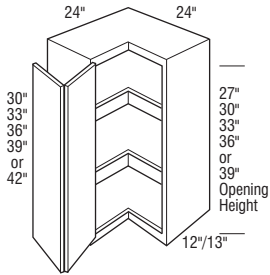

Top View

	Cubic Feet	1	2	3	4	5	6	7
ER30 L or R	12.3	1725	1754	1851	1966	2047	2228	2409
ER33 L or R	13.5	1984	2015	2127	2257	2357	2567	2777
ER36 L or R	14.7	2075	2126	2243	2369	2458	2673	2888
ER39 L or R	15.8	2387	2444	2578	2721	2827	3077	3327
ER42 L or R	17.0	2468	2501	2642	2810	2911	3170	3429

- Includes two shelves.

- Includes three shelves.

Notes below apply to all products in section above:

- Doors are connected with bifold hinge.
- End panels must be equal in size.
- Inset and Beaded Inset Door Styles are a standard 13" deep.
- Increased Depths available in 3" increments to 15".
- Reduced Depths available in 3" increments to 9".

Door & Drawer Options

AF	AOMD	CC	CG	GAMD	HC	IFHG	MC	MD	MFO	PRMD	SHMD	SPLITDR	SPLITDRWS	TCG	TCP
							✓			✓					

End Panel Options

AUTH	CSFPE	EXBK	EXDN	FFD	FL/FR	FPE	INTGE	IPE
✓	✓		✓		✓	✓	✓	✓

Custom Modification Options

ADD_SHLF	ADDTK	ADRW	BVR	CBO	CCO	CFNTO	CFRMO	CLIP	CND	CSDGBK	EX	EX_OL	F.ALL	FBFL	FLUT ¹	FTK	ID	IH
	✓		✓	✓	✓	✓	✓		✓	✓	✓	✓	✓		✓	✓	✓	✓

INVFRM	IW	LIGHT	MIP	OBRB	PFINBTMB	RD	RECTK	RH ²	ROSLUT	RT	RW	STW	TD	TKP	TVR	WS	WTR
	✓	✓	✓	✓	✓	✓	✓	✓	✓	✓	✓	✓	✓	✓	✓	✓	✓

¹ Not available with 6" fluting.

² Only available on 30" high.

ASYMMETRICAL EASY REACH WALL CORNER, 30", 33", or 36" HIGH

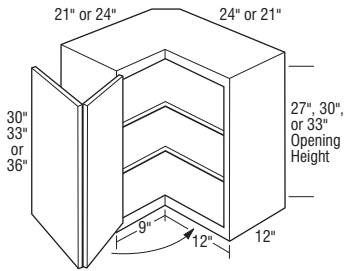

ER302121 L or R	9.6	1658	1686	1779	1890	1968	2142	2316
ER302124 L or R	12.3	1725	1754	1851	1966	2047	2228	2409
ER302421 L or R	12.3	1725	1754	1851	1966	2047	2228	2409
ER332121 L or R	10.6	1780	1811	1911	2030	2113	2300	2487
ER332124 L or R	11.9	1903	1935	2042	2169	2259	2458	2657
ER332421 L or R	11.9	1903	1935	2042	2169	2259	2458	2657
ER362121 L or R	11.5	1903	1935	2042	2169	2259	2458	2657
ER362124 L or R	14.7	2075	2126	2243	2369	2458	2673	2888
ER362421 L or R	14.7	2075	2126	2243	2369	2458	2673	2888

- Includes two adjustable shelves.
- Hinged door opens to 170°.
- Legs at the front frames are 9" on 21" leg and 12" on 24" leg.
- ER __ 2124 L shown.
- Not available on Inset and Beaded Inset styles.

Door & Drawer Options

AF	AOMD	CC	CG	GAMD	HC	IFHG	MC	MD	MFO	PRMD	SHMD	SPLITDR	SPLITDRWS	TCG	TCP
										✓					

End Panel Options

AUTH	CSFPE	EXBK	EXDN	FFD	FL/FR	FPE	INTGE	IPE
✓	✓		✓		✓	✓	✓	✓

Custom Modification Options

ADD_SHLF	ADDTK	ADRW	BVR	CBO	CCO	CFNTO	CFRMO	CLIP	CND	CSDGBK	EX	EX_OL	F.ALL	FBFL	FLUT ¹	FTK	ID	IH
	✓		✓	✓	✓	✓	✓		✓	✓	✓	✓	✓		✓	✓	✓	✓

INVFRM	IW	LIGHT	MIP	OBRB	PFINBTMB	RD	RECTK	RH ²	ROSLUT	RT	RW	STW	TD	TKP	TVR	WS	WTR
	✓	✓	✓	✓	✓	✓	✓	✓	✓	✓	✓	✓	✓	✓	✓	✓	✓

¹ Not available with 6" fluting.

² Only available on 30" high.

IH/RH availability charts starting on page G-40.
IW/RW availability charts starting on page G-46.

ASYMMETRICAL EASY REACH WALL CORNER, 39" or 42" HIGH

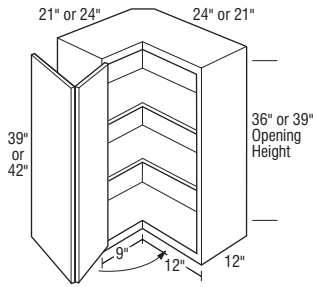

	Cubic Feet	1	2	3	4	5	6	7
ER392121 L or R	12.4	2287	2326	2455	2607	2715	2955	3195
ER392124 L or R	15.8	2387	2444	2578	2721	2827	3077	3327
ER392421 L or R	15.8	2387	2444	2578	2721	2827	3077	3327

ER422121 L or R	13.3	2361	2402	2534	2692	2803	3051	3299
ER422124 L or R	17.0	2468	2501	2642	2810	2911	3170	3429
ER422421 L or R	17.0	2468	2501	2642	2810	2911	3170	3429

- Includes two adjustable shelves.
- Hinged door opens to 170°.
- Legs at the front frames are 9" on 21" leg and 12" on 24" leg.
- ER __ 2124 L shown.
- Not available on Inset and Beaded Inset styles.

Door & Drawer Options

AF	AOMD	CC	CG	GAMD	HC	IFHG	MC	MD	MFO	PRMD	SHMD	SPLITDR	SPLITDRWS	TCG	TCP
									✓						

End Panel Options

AUTH	CSFPE	EXBK	EXDN	FFD	FL/FR	FPE	INTGE	IPE
✓	✓		✓		✓	✓	✓	✓

Custom Modification Options

ADD_SHLF	ADDTK	ADRW	BVR	CBO	CCO	CFNTO	CFRMO	CLIP	CND	CSDGBK	EX	EX_OL	FALL	FBFL	FLUT ¹	FTK	ID	IH
	✓		✓	✓	✓	✓	✓		✓	✓	✓	✓			✓			✓

INVERM	IW	LIGHT ²	MIP	OBRB	PFINBTMB	RD	RECTK	RH	ROSLUT	RT	RW	STW	TD	TKP	TVR	WS	WTR
		✓		✓	✓		✓		✓					✓			✓

¹ Not available with 6" fluting.

² INT.LGT not available on 39" high.

Diagonal Wall Cabinets

DIAGONAL WALL, 12", 13", or 15" DEEP

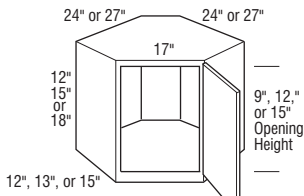

DW122424 L or R - DW182727 L or R

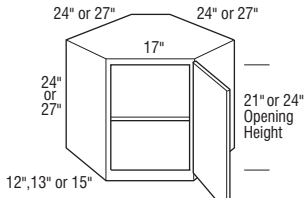

DW242424 L or R - DW272727 L or R

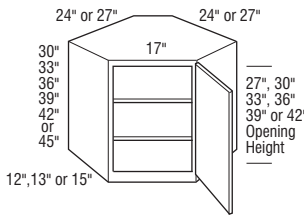

DW302424 L or R - DW452727 L or R

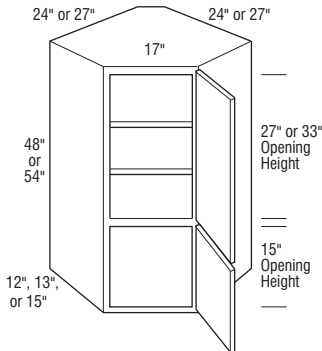

DW302424D L or R - DW362727D L or R

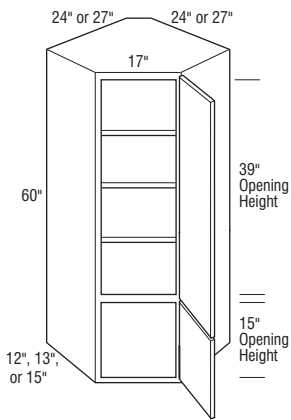

DW422424D L or R - DW422727D L or R

IH/RH availability charts starting on page G-40.
IW/RW availability charts starting on page G-46.

	Cubic Feet	1	2	3	4	5	6	7
DW122424 L or R	5.0	780	817	847	892	940	1024	1108
DW152424 L or R	6.1	876	918	952	1002	1056	1150	1244
DW182424 L or R	7.6	984	1032	1070	1126	1187	1292	1397
DW122727 L or R	6.2	829	868	897	948	997	1089	1181
DW152727 L or R	7.6	931	975	1008	1065	1120	1224	1328
DW182727 L or R	5.6	1046	1096	1133	1197	1258	1375	1492

DW242424 L or R	10.0	1097	1145	1192	1249	1315	1438	1561
DW272424 L or R	10.7	1152	1207	1252	1316	1390	1519	1648
DW242727 L or R	12.4	1207	1268	1311	1383	1465	1600	1735
DW272727 L or R	13.3	1211	1270	1316	1388	1461	1593	1725

• One adjustable shelf.

DW302424 L or R	12.3	1215	1272	1321	1393	1457	1586	1715
DW332424 L or R	13.5	1434	1500	1560	1644	1719	1872	2025
DW362424 L or R	14.7	1527	1600	1656	1746	1834	2004	2174
DW302727 L or R	15.3	1255	1315	1362	1438	1512	1645	1778
DW332727 L or R	16.8	1480	1550	1608	1699	1781	1942	2103
DW362727 L or R	18.2	1576	1651	1710	1796	1897	2068	2239

• Two adjustable shelves.

DW392424 L or R	15.8	1711	1791	1855	1955	2056	2246	2436
DW422424 L or R	17.0	1801	1887	1949	2059	2170	2373	2576
DW452424 L or R	18.2	2159	2266	2336	2470	2606	2847	3088
DW392727 L or R	19.7	1769	1848	1914	2010	2127	2318	2509
DW422727 L or R	21.2	1871	1960	2027	2132	2261	2465	2669
DW452727 L or R	22.6	2245	2357	2430	2559	2713	2960	3207

• Three adjustable shelves.

DW302424DWB L or R	19.4	2300	2412	2501	2631	2774	3032	3290
DW362424DWB L or R	21.7	2559	2681	2779	2927	3087	3374	3661
DW302727DWB L or R	24.1	2377	2487	2575	2715	2869	3130	3391
DW362727DWB L or R	27.0	2651	2774	2861	3025	3200	3490	3780

• Two adjustable shelves.

• Increased Heights modification will increase the height of the upper cabinet section. The bottom section will retain its original height.

DW422424DWB L or R	24.1	2815	2960	3053	3226	3393	3714	4035
DW422727DWB L or R	29.9	2917	3056	3154	3325	3526	3842	4158

• Three adjustable shelves.

• Increased Heights modification will increase the height of the upper cabinet section. The bottom section will retain its original height.

Notes below apply to all products in section above:

- All Full Overlay doors have a 3/4" overlay hinge standard.
- EXL or EXR not required on opposing cabinets.
- Inset and Beaded Inset Door Styles are a standard 13" deep.
- Adjustable shelf cannot be removed/retrofitted.

Door & Drawer Options

AF	AOMD	CC	CG	GAMD ¹	HC	IFHG	MC	MD ¹	MFO	PRMD	SHMD	SPLITDR	SPLITDRWS	TCG ²	TCP ²
✓	✓	✓	✓	✓	✓	✓	✓	✓	✓	✓	✓	✓	✓	✓	✓

End Panel Options

AUTH	CSFPE	EXBK	EXDN	FFD	FL/FR	FPE	INTGE	IPE
✓	✓	✓	✓	✓	✓	✓	✓	✓

Custom Modification Options

ADD	SHLF	ADTK	ADRW	BVR	CBO	CCO	CFNTO	CFRMO	CLIP	CND	CSDGBK	EX	EX_OL	F.ALL	FBFL	FLUT	FTK	ID	IH
✓	✓	✓	✓	✓	✓	✓	✓	✓	✓	✓	✓	✓	✓	✓	✓	✓	✓	✓	✓

INVERM ³	IW	LIGHT	MIP	OBRB	PFINBTMB	RD	RECTK	RH ⁴	ROSFLUT	RT	RW	STW	TD	TKP	TVR	WS	WTR
✓	✓	✓	✓	✓	✓	✓	✓	✓	✓	✓	✓	✓	✓	✓	✓	✓	✓

¹ Not available on 48", 54" or 60" high.

² Only available on 36", 39", 42", 45", 54", and 60" high.

³ Only available on 48", 54" and 60" high.

⁴ Only available on 15"-24" high.

DIAGONAL WALL with FULL HEIGHT DOOR, 48" HIGH

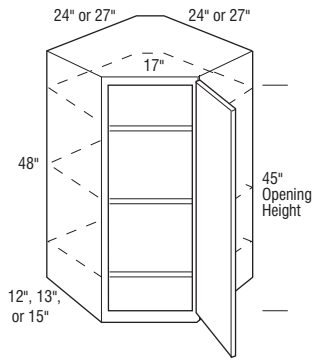

Cubic Feet	1	2	3	4	5	6	7	
DW482424FH L or R	19.4	2300	2412	2501	2631	2774	3032	3290
DW482727FH L or R	24.1	2642	2753	2843	2976	3116	3377	3638

- Three adjustable shelves.
- All Full Overlay doors have a 3/4" overlay hinge standard.
- EXL or EXR not required on opposing cabinets.
- Inset and Beaded Inset Door Styles are a standard 13" deep.

Door & Drawer Options

AF	AOMD	CC	CG	GAMD	HC	IFHG	MC	MD	MFO	PRMD	SHMD	SPLITDR	SPLITDRWS	TCG	TCP
✓		✓	✓	✓	✓	✓	✓	✓	✓	✓	✓			✓	✓

End Panel Options

AUTH	CSFPE	EXBK	EXDN	FFD	FL/FR	FPE	INTGE	IPE
✓	✓	✓	✓	✓	✓	✓	✓	✓

Custom Modification Options

ADD_SHLF	ADDTK	ADRW	BVR	CBO	CCO	CFNTO	CFRMO	CLIP	CND	CSDGBK	EX	EX_OL	FALL	FBFL	FLUT	FTK	ID	IH
	✓	✓	✓	✓	✓	✓	✓	✓	✓	✓						✓	✓	

INVFRM	IW	LIGHT	MIP	OBRB	PFINBTMB	RD	RECTK	RH	ROSLUT	RT	RW	STW	TD	TKP	TVR	WS	WTR
	✓	✓	✓	✓	✓	✓	✓	✓						✓	✓	✓	✓

Diagonal Wall Cabinets

DIAGONAL WALL with LAZY SUSAN, 30", 36", 39", 42", 48", or 60" HIGH

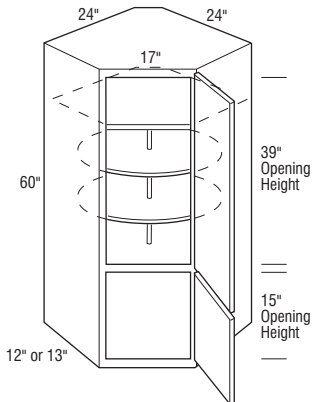
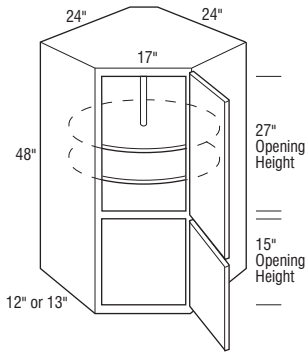
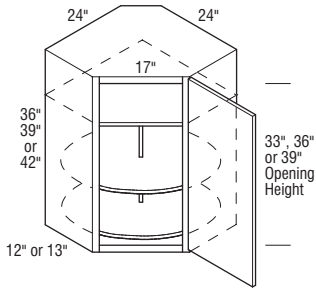
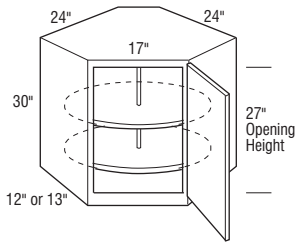

	Cubic Feet	1	2	3	4	5	6	7
DW302424S L or R	12.3	1907	2000	2069	2182	2312	2523	2734
DW362424S L or R	14.7	2240	2350	2431	2564	2716	2967	3218
DW392424S L or R	15.8	2372	2485	2574	2715	2876	3139	3402
DW422424S L or R	17.0	2507	2625	2719	2865	3035	3318	3601
• One fixed shelf.								
DW302424DSWB L or R	19.4	3061	3210	3321	3500	3709	4052	4395
• One fixed shelf.								
DW422424DSWB L or R	24.1	3609	3784	3918	4131	4375	4779	5183
• One fixed shelf.								

Notes below apply to all products in section above:

- Wood Pan diameter 18".
- All Full Overlay doors have a 3/4" overlay hinge standard.
- EXL or EXR not required on opposing cabinets.
- Inset and Beaded Inset Door Styles are a standard 13" deep.

Door & Drawer Options

AF	AOMD	CC	CG	GAMD	HC	IFHG	MC	MD	MFO	PRMD	SHMD	SPLITDR	SPLITDRWS	TCG ¹	TCP ¹
✓			✓			✓		✓	✓	✓	✓			✓	✓

End Panel Options

AUTH	CSFPE	EXBK	EXDN	FFD ²	FL/FR	FPE	INTGE	IPE
✓	✓		✓	✓	✓	✓	✓	✓

Custom Modification Options

ADD_SHLF	ADDTK	ADRW	BVR	CBO	CCO ³	CFNTO	CFRMO ³	CLIP	CND	CSDGBK	EX	EX_OL	F.ALL	FBFL	FLUT	FTK	ID	IH
	✓	✓	✓	✓	✓	✓	✓	✓	✓	✓								✓

INVERM ⁴	IW	LIGHT	MIP	OBRB	PFINBTMB	RD	RECTK	RH	ROSLUT	RT	RW	STW	TD	TKP	TVR	WS	WTR
✓	✓	✓	✓	✓	✓	✓	✓	✓	✓	✓	✓	✓	✓	✓	✓	✓	✓

¹ Not available on 30" or 48" high.

² Only available on 30" and 48" high.

³ Not available on 48" high.

⁴ Only available on 48" and 60" high.

IH/RH availability charts starting on page G•40.
IW/RW availability charts starting on page G•46.

DIAGONAL WALL with APPLIANCE GARAGE OPEN BOTTOM, 48", 51", 54", 57", or 60" HIGH

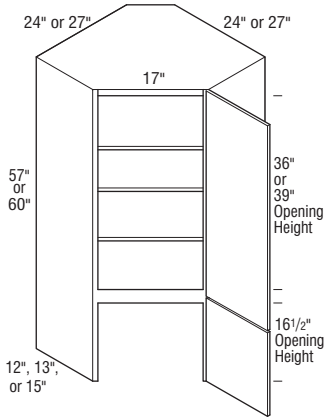
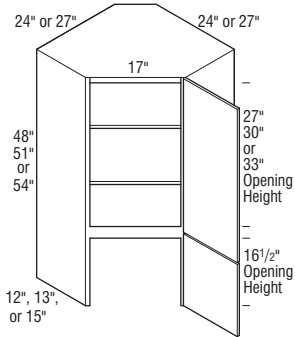

	Cubic Feet	1	2	3	4	5	6	7
DW302424D L or R	19.4	2057	2163	2248	2374	2510	2756	3002
DW332424D L or R	20.5	2213	2319	2405	2530	2665	2912	3159
DW362424D L or R	21.7	2304	2419	2513	2655	2807	3080	3353
DW302727D L or R	24.1	2128	2236	2318	2452	2599	2848	3097
DW332727D L or R	25.5	2292	2400	2481	2615	2763	3011	3259
DW362727D L or R	27.0	2389	2510	2591	2747	2914	3190	3466

- One fixed and two adjustable shelves.

DW392424D L or R	22.9	2467	2582	2677	2818	2970	3244	3518
DW422424D L or R	24.1	2545	2684	2774	2938	3099	3405	3711
DW392727D L or R	28.5	2554	2673	2756	2911	3078	3355	3632
DW422727D L or R	29.9	2644	2777	2870	3034	3224	3527	3830

- One fixed and three adjustable shelves.

Notes below apply to all products in section above:

- All Full Overlay doors have a 3/4" overlay hinge standard.
- EXL or EXR not required on opposing cabinets.
- Increased Heights modification will increase the height of the upper cabinet section. The bottom section will retain its original height.
- Bottom section does not include floor.

Door & Drawer Options

AF	AOMD	CC	CG	GAMD	HC	IFHG	MC	MD	MFO	PRMD	SHMD	SPLITDR	SPLITDRWS	TCG	TCP
✓			✓	✓	✓	✓	✓	✓	✓	✓	✓				

End Panel Options

AUTH	CSFPE	EXBK	EXDN	FFD	FL/FR	FPE	INTGE	IPE
✓	✓		✓		✓	✓	✓	✓

Custom Modification Options

ADD_SHLF	ADDTK	ADRW	BVR	CBO	CCO	CFNTO	CFRMO	CLIP	CND	CSDGBK	EX	EX_OL	F.ALL	FBFL	FLUT	FTK	ID	IH
				✓	✓	✓	✓		✓	✓							✓	✓

INVFRM	IW	LIGHT	MIP	OBRB	PFINBTMB	RD	RECTK	RH	ROSLUT	RT	RW	STW	TD	TKP	TVR ¹	WS	WTR	
		✓	✓													✓	✓	✓

¹ Only available on top section.

Diagonal Wall Cabinets

DIAGONAL WALL with APPLIANCE GARAGE and LAZY SUSAN OPEN BOTTOM, 48", 51", 54", 57", or 60" HIGH

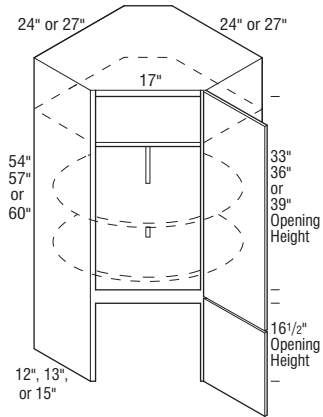
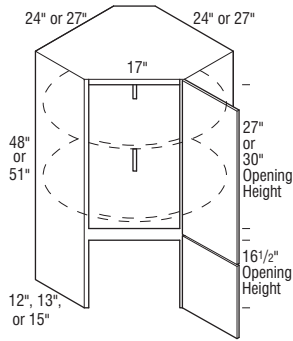

Cubic Feet	1	2	3	4	5	6	7	
DW302424DS L or R	19.4	2781	2923	3030	3201	3399	3727	4055
DW324242DS L or R	20.5	2944	3085	3192	3365	3564	3890	4216
DW362424DS L or R	21.7	3109	3249	3357	3528	3727	4053	4379
DW392424DS L or R	22.9	3244	3385	3492	3665	3864	4190	4516
DW422424DS L or R	24.1	3305	3470	3598	3801	4035	4421	4807

- One fixed shelf.

- Two fixed shelves.

Notes below apply to all products in section above:

- Wood Pan diameter 18".
- All Full Overlay doors have a 3/4" overlay hinge standard.
- EXL or EXR not required on opposing cabinets.
- Bottom section does not include floor.

Door & Drawer Options

AF	AQMD	CC	CG	GAMD	HC	IFHG	MC	MD	MFO	PRMD	SHMD	SPLITDR	SPLITDRWS	TCG	TCP
✓		✓	✓			✓		✓	✓	✓	✓				

End Panel Options

AUTH	CSFPE	EXBK	EXDN	FFD	FL/FR	FPE	INTGE	IPE
✓	✓			✓	✓	✓	✓	✓

Custom Modification Options

ADD_SHLF	ADDTK	ADRW	BVR	CBO	CCO	CFNTO	CFRMO	CLIP	CND	CSDGBK	EX	EX_OL	F.ALL	FBFL	FLUT	FTK	ID	IH
				✓	✓	✓	✓	✓	✓	✓								✓

INVFRM	IW	LIGHT	MIP	OBRB	PFINBTMB	RD	RECTK	RH	ROSLUT	RT	RW	STW	TD	TKP	TVR ¹	WS	WTR
	✓	✓	✓												✓	✓	✓

¹ Only available on top section.

IH/RH availability charts starting on page G-40.
IW/RW availability charts starting on page G-46.

DIAGONAL WALL with VERTICAL-LIFT, 48", 51", 54", 57", or 60" HIGH, 12" or 15" DEEP

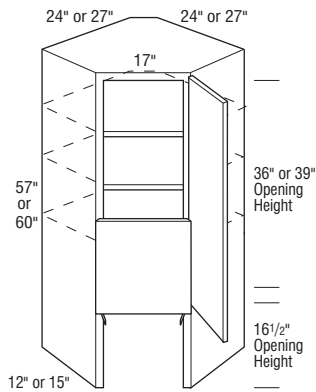
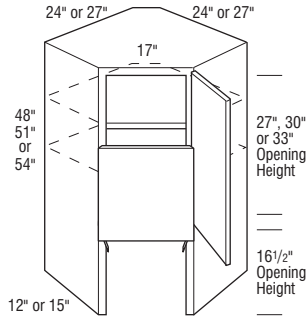

	Cubic Feet	1	2	3	4	5	6	7
DW302424AG L or R	19.4	3501	3670	3800	4010	4247	4637	5027
DW332424AG L or R	20.5	3751	3930	4072	4291	4545	4965	5385
DW362424AG L or R	21.7	3841	4026	4168	4397	4655	5088	5521
DW392424AG L or R	22.9	4120	4319	4474	4714	4996	5455	5914
DW422424AG L or R	24.1	4245	4447	4606	4856	5145	5618	6091

• One fixed and two adjustable shelves.

DW302727AG L or R	24.1	3582	3756	3886	4099	4343	4742	5141
DW332727AG L or R	25.5	3837	4023	4164	4390	4649	5079	5509
DW362727AG L or R	27.0	3921	4109	4254	4488	4750	5191	5632
DW392727AG L or R	28.5	4207	4409	4568	4815	5099	5570	6041
DW422727AG L or R	29.9	4329	4538	4698	4951	5247	5733	6219

• One fixed and three adjustable shelves.

Notes below apply to all products in section above:

- Heavy duty Vertical-Lift mechanism.
- All Full Overlay doors have a 3/4" overlay hinge standard.
- EXL or EXR not required on opposing cabinets.
- Not available on Inset and Beaded Inset styles.
- Increased Heights modification will increase the height of the upper cabinet section. The bottom section will retain its original height.
- Automatic Opening Mechanism is available except when used with the following door styles:
 - Brooks, Gunther, Karis, Langley, Montgomery, Shona, or Vesta.

Door & Drawer Options

AF	AOMD	CC	CG	GAMD	HC	IFHG	MC	MD	MFO	PRMD	SHMD	SPLITDR	SPLITDRWS	TCG ¹	TCP ¹
✓	✓	✓	✓	✓	✓	✓	✓	✓	✓	✓	✓	✓	✓	✓	✓

End Panel Options

AUTH	CSFPE	EXBK	EXDN	FFD	FL/FR	FPE	INTGE	IPE
✓	✓	✓	✓	✓	✓	✓	✓	✓

Custom Modification Options

ADD_SHLF	ADDTK	ADRW	BVR	CBO	CCO	CFNTO	CFRMO	CLIP	CND	CSDGBK	EX	EX_OL	F.ALL	FBFL	FLUT	FTK	ID	IH
				✓					✓	✓								✓

INVFRM	IW	LIGHT	MIP	OBRB	PFINBTMB	RD	RECTK	RH	ROSLUT	RT	RW	STW	TD	TKP	TVR	WS	WTR
		✓	✓														✓

¹ Not available on 48" or 51" high.

Diagonal Wall Cabinets

DIAGONAL WALL with VERTICAL-LIFT and LAZY SUSAN, 48", 54", or 60" HIGH

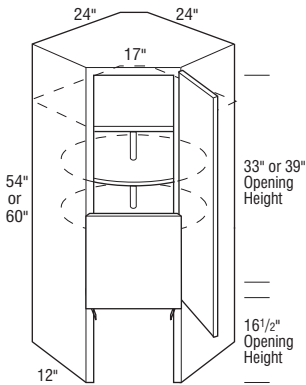
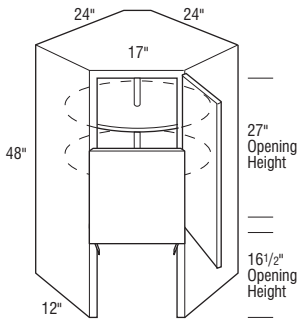

	Cubic Feet	1	2	3	4	5	6	7
DW302424AGS L or R	19.4	4352	4561	4724	4980	5276	5760	6244
DW362424AGS L or R	21.7	4709	4935	5109	5387	5708	6236	6764
DW422424AGS L or R	24.1	5145	5394	5580	5886	6236	6809	7382

• One fixed shelf.

• Two fixed shelves.

Notes below apply to all products in section above:

- Heavy duty Vertical-Lift mechanism.
- Wood Pan diameter 18".
- All Full Overlay doors have a 3/4" overlay hinge standard.
- EXL or EXR not required on opposing cabinets.
- Not available on Inset and Beaded Inset styles.
- Automatic Opening Mechanism is available except when used with the following door styles:
 - Brooks, Gunther, Karis, Langley, Montgomery, Shona, or Vesta.

Door & Drawer Options

AF	AOMD	CC	CG	GAMD	HC	IFHG	MC	MD	MFO	PRMD	SHMD	SPLITDR	SPLITDRWS	TCG	TCP
✓			✓	✓				✓	✓	✓	✓				

End Panel Options

AUTH	CSFPE	EXBK	EXDN	FFD	FL/FR	FPE	INTGE	IPE
✓	✓				✓	✓	✓	

Custom Modification Options

ADD_SHLF	ADDTK	ADRW	BVR	CBO	CCO	CFNTD	CFRMO	CLIP	CND	CSDGBK	EX	EX_OL	F.ALL	FBFL	FLUT	FTK	ID	IH
										✓								

INVFRM	IW	LIGHT	MIP	OBRB	PFINBTMB	RD	RECTK	RH	ROSLUT	RT	RW	STW	TD	TKP	TVR	WS	WTR
			✓	✓													✓

STACKED DIAGONAL WALL, 48", 51", 54", 57", or 60" HIGH

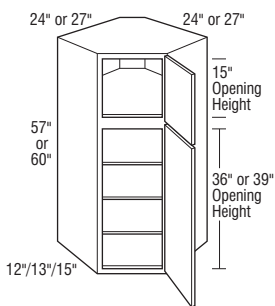
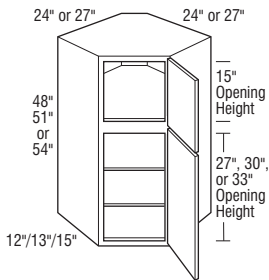

STDW482424 L or R	18.7	2300	2412	2501	2631	2774	3032	3290
STDW512424 L or R	20.5	2430	2547	2640	2779	2931	3203	3475
STDW542424 L or R	20.9	2559	2681	2779	2927	3087	3374	3661
STDW482727 L or R	23.3	2377	2487	2575	2715	2869	3130	3391
STDW512727 L or R	25.5	2514	2631	2718	2870	3035	3310	3585
STDW542727 L or R	26.1	2651	2774	2861	3025	3200	3490	3780

• Two adjustable shelves.

STDW572424 L or R	21.6	2733	2867	2957	3126	3297	3602	3907
STDW602424 L or R	23.2	2815	2960	3053	3226	3393	3714	4035
STDW572727 L or R	26.8	2866	3008	3104	3276	3460	3778	4096
STDW602727 L or R	29.0	2917	3056	3154	3325	3526	3842	4158

• Three adjustable shelves.

Notes below apply to all products in section above:

- All Full Overlay doors have a 3/4" overlay hinge standard.
- EXL or EXR not required on opposing cabinets.
- Inset and Beaded Inset Door Styles are a standard 13" deep.
- Increased Heights modification will increase the height of the upper cabinet section. The bottom section will retain its original height.

Door & Drawer Options

AF	AOMD	CC	CG	GAMD	HC	IFHG	MC	MD	MFO	PRMD	SHMD	SPLITDR	SPLITDRWS	TCG	TCP
			✓				✓	✓	✓	✓					

End Panel Options

AUTH	CSFPE	EXBK	EXDN	FFD	FL/FR	FPE	INTGE	IPE
✓	✓				✓	✓	✓	

Custom Modification Options

ADD_SHLF	ADDTK	ADRW	BVR	CBO	CCO	CFNTD	CFRMO	CLIP	CND	CSDGBK	EX	EX_OL	F.ALL	FBFL	FLUT	FTK	ID	IH
										✓								

INVFRM	IW	LIGHT	MIP	OBRB	PFINBTMB	RD	RECTK	RH	ROSLUT	RT	RW	STW	TD	TKP	TVR	WS	WTR
			✓	✓													✓

IH/RH availability charts starting on page G-40.
IW/RW availability charts starting on page G-46.

Diagonal Wall Peninsula Cabinets

DIAGONAL WALL PENINSULA, 30", 33", 36", 39", 42", 45", or 48" HIGH

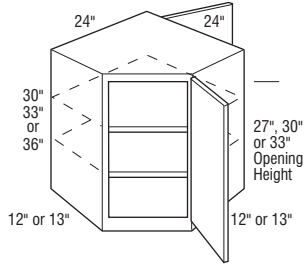

DW*PRR shown

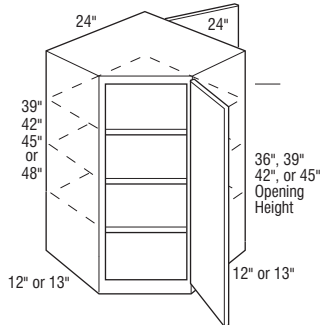

DW*PRR shown

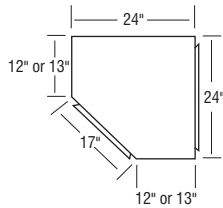

DW*PRR shown

	Cubic Feet	1	2	3	4	5	6	7
DW302424PLL	12.3	2004	2106	2184	2303	2416	2642	2868
DW302424PRR	12.3	2004	2106	2184	2303	2416	2642	2868
DW302424PLR	12.3	2004	2106	2184	2303	2416	2642	2868
DW302424PRL	12.3	2004	2106	2184	2303	2416	2642	2868

• Reduced Heights available in 1/4" increments. See page G-40 for details.

DW332424PLL	13.5	2367	2481	2574	2713	2852	3116	3380
DW332424PRR	13.5	2367	2481	2574	2713	2852	3116	3380
DW332424PLR	13.5	2367	2481	2574	2713	2852	3116	3380
DW332424PRL	13.5	2367	2481	2574	2713	2852	3116	3380
DW362424PLL	14.7	2511	2629	2722	2866	3029	3302	3575
DW362424PRR	14.7	2511	2629	2722	2866	3029	3302	3575
DW362424PLR	14.7	2511	2629	2722	2866	3029	3302	3575
DW362424PRL	14.7	2511	2629	2722	2866	3029	3302	3575

• Two adjustable shelves.

DW392424PLL	15.8	2759	2893	2995	3157	3328	3634	3940
DW392424PRR	15.8	2759	2893	2995	3157	3328	3634	3940
DW392424PLR	15.8	2759	2893	2995	3157	3328	3634	3940
DW392424PRL	15.8	2759	2893	2995	3157	3328	3634	3940
DW422424PLL	17.0	2946	3090	3207	3383	3552	3886	4220
DW422424PRR	17.0	2946	3090	3207	3383	3552	3886	4220
DW422424PLR	17.0	2946	3090	3207	3383	3552	3886	4220
DW422424PRL	17.0	2946	3090	3207	3383	3552	3886	4220
DW452424PLL	18.2	3536	3708	3844	4057	4259	4666	5073
DW452424PRR	18.2	3536	3708	3844	4057	4259	4666	5073
DW452424PLR	18.2	3536	3708	3844	4057	4259	4666	5073
DW452424PRL	18.2	3536	3708	3844	4057	4259	4666	5073
DW482424PLL	19.4	3772	3956	4104	4323	4547	4975	5403
DW482424PRR	19.4	3772	3956	4104	4323	4547	4975	5403
DW482424PLR	19.4	3772	3956	4104	4323	4547	4975	5403
DW482424PRL	19.4	3772	3956	4104	4323	4547	4975	5403

• Three adjustable shelves.

Notes below apply to all products in section above:

- First letter is hinging of front door. Second letter is side of cabinet the Peninsula will be on and the hinging of that door.
- Peninsula one side only.
- All Full Overlay doors have a 3/4" overlay hinge standard.
- EXL or EXR not required on opposing cabinets.
- Inset and Beaded Inset Door Styles are a standard 13" deep.

Door & Drawer Options

AF	AOMD	CC	CG	GAMD	HC	IFHG	MC	MD	MFO	PRMD	SHMD	SPLITDR	SPLITDRWS	TCG ¹	TCP ¹
✓	✓	✓	✓	✓	✓	✓	✓	✓	✓	✓	✓	✓	✓	✓	✓

End Panel Options

AUTH	CSFPE	EXBK	EXDN ²	FFD	FL/FR	FPE	INTGE	IPE
✓	✓	✓	✓	✓	✓	✓	✓	✓

Custom Modification Options

ADD_SHLF	ADDTK	ADRW	BVR	CBO	CCO	CFNTD	CFRMO	CLIP	CND	CSDGBK	EX	EX_OL	FALL	FBFL	FLUT ³	FTK	ID	IH
✓	✓	✓	✓	✓	✓	✓	✓	✓	✓	✓	✓	✓	✓	✓	✓	✓	✓	✓

INVERM	IW	LIGHT	MIP	OBRB	PFINBTMB	RD	RECTK ⁴	RH ⁵	ROSFLUT	RT	RW	STW	TD	TKP	TVR	WS	WTR
✓	✓	✓	✓	✓	✓	✓	✓	✓	✓	✓	✓	✓	✓	✓	✓	✓	✓

¹ Not available on 30" or 33" high.

² Not available on EXDNLRB.

³ Not available with 6" fluting.

⁴ Not available on 48" high.

⁵ Only available on 30" high.

Wall Peninsula Cabinets

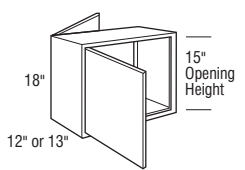
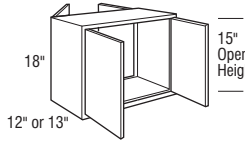
		Cubic Feet	1	2	3	4	5	6	7
WALL PENINSULA, 18" HIGH	W918P L or R	1.7	1115	1170	1212	1278	1346	1469	1592
	W1218P L or R	2.2	1163	1218	1261	1330	1401	1529	1657
	W1518P L or R	2.7	1186	1244	1287	1357	1429	1561	1693
	W1818P L or R	3.2	1220	1281	1324	1399	1470	1608	1746
	W2118P L or R	3.7	1257	1318	1367	1441	1516	1656	1796
	W2418P L or R	4.2	1281	1341	1391	1463	1546	1690	1834
	W2418P	4.2	1586	1662	1719	1811	1926	2099	2272
	W2718P	4.7	1902	1997	2068	2185	2303	2512	2721
	W3018P	5.2	1968	2062	2132	2252	2374	2593	2812
	W3318P	5.6	2031	2129	2207	2326	2441	2672	2903
	W3618P	6.1	2106	2207	2287	2415	2537	2781	3025
	W3918P	6.6	2159	2265	2342	2473	2602	2843	3084
	W4218P	7.1	2219	2326	2412	2540	2672	2914	3156
	W4518P	7.6	2355	2468	2556	2695	2836	3099	3362
	W4818P	8.1	2417	2532	2624	2765	2924	3195	3466

Notes below apply to all products in section above:

- Specify location of modification for front or peninsula side.
- Inset and Beaded Inset Door Styles are a standard 13" deep.
- Full Overlay Styles:
 - Increased Depths available in 1/4" increments from 12 1/4" to 30".
 - Reduced Depths available in 1/4" increments from 6" to 11 3/4".
- Inset and Beaded Inset Styles:
 - Increased Depths available in 1/4" increments from 13 1/4" to 30".
 - Reduced Depths available in 1/4" increments from 6" to 12 3/4".
- Exceptions may apply when using IW with Wide Stiles. Please reference these sections in Section G for more details.

Door & Drawer Options

AF	AOMD	CC	CG	GAMD ¹	HC	IFHG	MC	MD ¹	MFO	PRMD ³	SHMD	SPLITDR ²	SPLITDRWS	TCG	TCP
✓			✓	✓		✓		✓	✓	✓		✓			

End Panel Options

AUTH	CSFPE	EXBK	EXDN ⁴	FFD	FL/FR	FPE	INTGE	IPE
✓	✓	✓	✓	✓	✓	✓	✓	✓

Custom Modification Options

ADD	SHLF	ADTK	ADRW	BVR	CBO	CCO	CFNTO	CFRMO	CLIP ⁵	CND	CSDGBK	EX	EX_OL	FALL	FBFL	FLUT ⁶	FTK ⁸	ID	IH
				✓	✓	✓			✓	✓		✓	✓			✓	✓	✓	✓

INVFRM	IW ⁹	LIGHT	MIP	OBRB	PFINBTMB	RD	RECTK	RH	ROSFLUT ⁷	RT	RW	STW	TD	TKP	TVR ¹⁰	WS	WTR
	✓	✓	✓	✓	✓	✓	✓	✓	✓	✓	✓	✓	✓	✓	✓	✓	✓

¹ Not available on 9" wide.
² Not available on 9" or 24" (2 doors) wide.
³ Only available on 24" (2 doors)-39" wide.
⁴ Not available with EXDNLRB.
⁵ Not available on 9" or 24" (2 doors) wide.
⁶ Not available on 9" or 24" (2 doors) wide and fluting both not available on 27"-36", 42" or 48" wide. Not available with 6" fluting.
⁷ Not available on 9" and 24" (2 doors) wide except on fluting both peninsula. Fluting both 3" not available on 27"-36", 42" or 48" wide except on fluting both peninsula.
⁸ FTKAV and style B-L not available on 9" or 12" wide.
⁹ Not available on 24" (1 door) or 48" wide.
¹⁰ Not available on 45" or 48" wide and TVRAV and style B-L not available on 9"-15".

IH/RH availability charts starting on page G•40.
 IW/RW availability charts starting on page G•46.

Wall Peninsula Cabinets

WALL PENINSULA, 24" HIGH

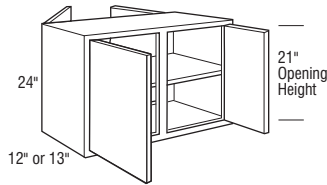
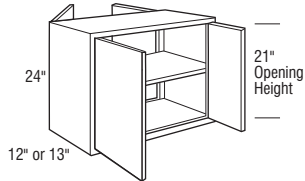
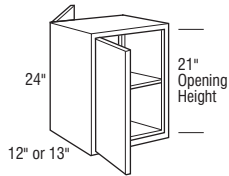

	Cubic Feet	1	2	3	4	5	6	7
W924P L or R	2.2	1213	1277	1316	1389	1469	1608	1747
W1224P L or R	2.9	1292	1353	1401	1474	1565	1710	1855
W1524P L or R	3.5	1305	1367	1416	1500	1565	1712	1859
W1824P L or R	4.2	1348	1416	1463	1540	1631	1780	1929
W2124P L or R	4.8	1393	1460	1512	1597	1679	1838	1997
W2424P L or R	5.5	1448	1519	1572	1656	1749	1914	2079
W2424P	5.5	1947	2047	2117	2225	2363	2577	2791
W2724P	6.1	2051	2149	2225	2340	2455	2681	2907
W3024P	6.7	2123	2225	2303	2423	2559	2795	3031
W3324P	7.4	2188	2296	2377	2512	2649	2897	3145
W3624P	8.0	2276	2387	2473	2615	2747	2999	3251
W3924P	8.7	2334	2455	2545	2679	2834	3093	3352
W4224P	9.3	2410	2524	2622	2764	2914	3186	3458
W4524P	9.9	2538	2665	2759	2904	3079	3363	3647
W4824P	10.6	2656	2786	2885	3046	3203	3508	3813

Notes below apply to all products in section above:

- One adjustable shelf.
- Specify location of modification for front or peninsula side.
- Inset and Beaded Inset Door Styles are a standard 13" deep.
- Full Overlay Styles:
 - Increased Depths available in 1/4" increments from 12 1/4" to 30".
 - Reduced Depths available in 1/4" increments from 6" to 11 3/4".
- Inset and Beaded Inset Styles:
 - Increased Depths available in 1/4" increments from 13 1/4" to 30".
 - Reduced Depths available in 1/4" increments from 6" to 12 3/4".
- Exceptions may apply when using IW with Wide Stiles. Please reference these sections in Section 6 for more details.

Door & Drawer Options

AF	AOMD	CC	CG	GAMD ¹	HC	IFHG	MC	MD ¹	MFO	PRMD ²	SHMD	SPLITDR ³	SPLITDRWS	TCG	TCP
✓			✓	✓	✓	✓	✓	✓	✓	✓	✓	✓	✓		

End Panel Options

AUTH	CSFPE	EXBK ⁴	EXDN ⁵	FFD	FL/FR	FPE	INTGE	IPE
✓	✓	✓	✓		✓	✓	✓	✓

Custom Modification Options

ADD_SHLF	ADDTK	ADRW	BVR	CBO	CCO	CFNT0 ⁶	CFRMO ⁶	CLIP ²	CND	CSDGBK	EX	EX_OL	F.ALL	FBFL	FLUT ⁷	FTK ⁸	ID	IH
			✓	✓	✓	✓	✓	✓	✓	✓	✓	✓	✓	✓	✓	✓	✓	✓
INVERM	IW ⁹	LIGHT	MIP	OBRB	PFINBTMB	RD	RECTK	RH ¹⁰	ROSFLUT ¹¹	RT	RW	STW	TD	TKP	TVR ¹²	WS	WTR	
✓	✓		✓	✓	✓	✓	✓	✓	✓	✓	✓	✓	✓	✓	✓	✓	✓	

¹ Not available on 9" wide.

² Not available on 9", 12" or 24" (2 doors) wide.

³ Only available on 24" (2 doors)-39" wide.

⁴ Not available with end extended back left.

⁵ Not available on EXDNLRB.

⁶ Only available on 9" wide.

⁷ Not available on 24" (2 doors) wide and fluting both not available on 27"-48" wide. Not available with 6" fluting.

⁸ FTKAV and style B-L not available on 9" or 12" wide.

⁹ Not available on 24" (1 door) or 48" wide.

¹⁰ Not available on 36"-48" wide.

¹¹ Not available on 24" (2 doors) wide and fluting both not available on 27"-48" wide except on fluting both peninsula.

¹² Not available on 42"-48" wide and TVRAV and style B-L not available on 9" or 12" wide.

Wall Peninsula Cabinets

WALL PENINSULA, 30" HIGH

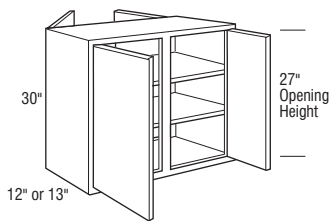
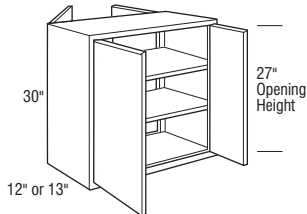
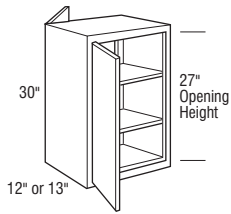

	Cubic Feet	1	2	3	4	5	6	7
W930P L or R	2.8	1251	1311	1357	1432	1507	1646	1785
W1230P L or R	3.6	1302	1367	1415	1491	1568	1715	1862
W1530P L or R	4.4	1341	1406	1447	1527	1624	1773	1922
W1830P L or R	5.2	1393	1460	1512	1597	1679	1838	1997
W2130P L or R	5.9	1450	1522	1576	1658	1755	1923	2091
W2430P L or R	6.7	1500	1568	1628	1715	1806	1970	2134
W2430P	6.7	2102	2208	2282	2404	2549	2786	3023
W2730P	7.5	2187	2292	2374	2511	2646	2891	3136
W3030P	1.2	2273	2382	2470	2607	2741	2997	3253
W3330P	9.1	2361	2470	2566	2704	2847	3111	3375
W3630P	9.9	2441	2564	2652	2797	2948	3227	3506
W3930P	10.7	2523	2649	2736	2885	3052	3331	3610
W4230P	11.5	2603	2727	2818	2977	3146	3438	3730
W4530P	12.3	2800	2936	3039	3207	3377	3691	4005
W4830P	13.1	2858	2997	3106	3276	3444	3762	4080

Notes below apply to all products in section above:

- Two adjustable shelves.
- Specify location of modification for front or peninsula side.
- Inset and Beaded Inset Door Styles are a standard 13" deep.
- Full Overlay Styles:
 - Increased Depths available in 1/4" increments from 12 1/4" to 30".
 - Reduced Depths available in 1/4" increments from 6" to 11 3/4".
- Inset and Beaded Inset Styles:
 - Increased Depths available in 1/4" increments from 13 1/4" to 30".
 - Reduced Depths available in 1/4" increments from 6" to 12 3/4".
- Exceptions may apply when using IW with Wide Shles. Please reference these sections in Section G for more details.

Door & Drawer Options

AF	AOMD	CC	CG	GAMD ¹	HC ¹	IFHG	MC ¹	MD ¹	MFO	PRMD ²	SHMD	SPLITDR ³	SPLITDRWS	TCG	TCP
✓	✓	✓	✓	✓	✓	✓	✓	✓	✓	✓	✓	✓	✓	✓	✓

End Panel Options

AUTH	CSFPE	EXBK ⁴	EXDN ⁵	FFD	FL/FR	FPE	INTGE	IPE
✓	✓	✓	✓	✓	✓	✓	✓	✓

Custom Modification Options

ADD_SHLF	ADDTK	ADRW	BVR	CBO	CCO	CFNT0	CFRMO	CLIP ²	CND	CSDGBK	EX	EX_OL	FALL	FBFL	FLUT ⁶	FTK ⁷	ID	IH
✓	✓	✓	✓	✓	✓	✓	✓	✓	✓	✓	✓	✓	✓	✓	✓	✓	✓	✓
INVERM	IW ⁸	LIGHT	MIP	OBRB	PFINBTMB	RD	RECTK	RH	ROSLUT ⁹	RT	RW	STW	TD	TKP	TVR ¹⁰	WS	WTR	
✓	✓	✓	✓	✓	✓	✓	✓	✓	✓	✓	✓	✓	✓	✓	✓	✓	✓	✓

¹ Not available on 9" wide.

² Not available on 9" or 24" (2 doors) wide.

³ Only available on 24" (2 doors)-39" wide.

⁴ Not available on 9" or 12" wide and not available with end extended back left.

⁵ Not available on EXDNLRB.

⁶ Not available on 9" or 24" (2 doors) wide and fluting both not available on 27"-48" wide. Not available with 6" fluting.

⁷ FTKAV and style B-L not available on 9" or 12" wide.

⁸ Not available on 24" (1 door) or 48" wide.

⁹ Not available on 9" or 24" (2 doors) wide and fluting both not available on 27"-48" wide except with fluting both peninsula.

¹⁰ Not available on 42"-48" wide and TVRAV and style B-L not available on 9" or 12" wide.

IH/RH availability charts starting on page G-40.
IW/RW availability charts starting on page G-46.

Wall Peninsula Cabinets

WALL PENINSULA, 36" HIGH

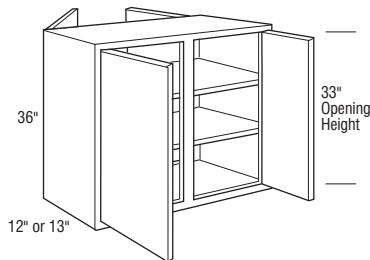
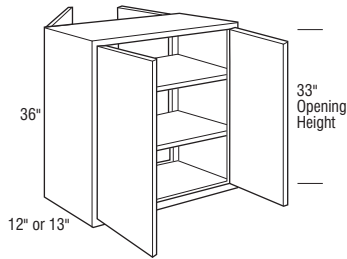
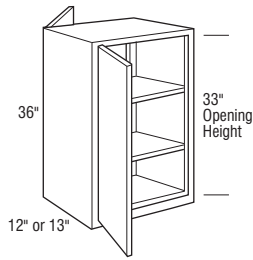

	Cubic Feet	1	2	3	4	5	6	7
W936P L or R	3.3	1315	1379	1429	1507	1583	1733	1883
W1236P L or R	4.2	1381	1448	1501	1581	1667	1819	1971
W1536P L or R	5.2	1450	1522	1576	1658	1744	1899	2054
W1836P L or R	6.1	1520	1592	1651	1738	1815	1979	2143
W2136P L or R	7.1	1580	1656	1719	1811	1897	2074	2251
W2436P L or R	8.0	1635	1712	1773	1869	1947	2129	2311
W2436P	8.0	2296	2417	2482	2624	2753	3006	3259
W2736P	9.0	2382	2506	2578	2722	2852	3120	3388
W3036P	9.9	2473	2594	2685	2837	2961	3234	3507
W3336P	10.9	2566	2689	2789	2943	3068	3357	3646
W3636P	11.8	2652	2781	2882	3039	3174	3465	3756
W3936P	12.7	2722	2855	2957	3117	3281	3587	3893
W4236P	13.7	2804	2940	3043	3211	3379	3693	4007
W4536P	14.6	3003	3148	3261	3440	3620	3956	4292
W4836P	15.6	3068	3218	3331	3517	3699	4044	4389

Notes below apply to all products in section above:

- Two adjustable shelves.
- Specify location of modification for front or peninsula side.
- Inset and Beaded Inset Door Styles are a standard 13" deep.
- Full Overlay Styles:
 - Increased Depths available in 1/4" increments from 12 1/4" to 30".
 - Reduced Depths available in 1/4" increments from 6" to 11 3/4".
- Inset and Beaded Inset Styles:
 - Increased Depths available in 1/4" increments from 13 1/4" to 30".
 - Reduced Depths available in 1/4" increments from 6" to 12 3/4".
- Exceptions may apply when using IW with Wide Stiles. Please reference these sections in Section 6 for more details.

Door & Drawer Options

AF	AOMD	CC	CG	GAMD ¹	HC ¹	IFHG	MC ¹	MD ¹	MFO	PRMD ²	SHMD	SPLITDR ³	SPLITDRWS	TCG ⁴	TCP ⁴
✓	✓	✓	✓	✓	✓	✓	✓	✓	✓	✓	✓	✓	✓	✓	✓

End Panel Options

AUTH	CSFPE	EXBK ⁵	EXDN ⁶	FFD	FL/FR	FPE	INTGE	IPE
✓	✓	✓	✓	✓	✓	✓	✓	✓

Custom Modification Options

ADD_SHLF	ADDTK	ADRW	BVR	CBO	CCO	CFNTO	CFRMO	CLIP ²	CND	CSDGBK	EX	EX_OL	FALL	FBFL	FLUT ⁷	FTK ⁸	ID	IH
✓	✓	✓	✓	✓	✓	✓	✓	✓	✓	✓	✓	✓	✓	✓	✓	✓	✓	✓
INVERM	IW ⁹	LIGHT	MIP	OBRB	PFINBTMB	RD	RECTK	RH	ROSFLOT ¹⁰	RT	RW	STW	TD	TRP	TVR ¹¹	WS	WTR	
✓	✓	✓	✓	✓	✓	✓	✓	✓	✓	✓	✓	✓	✓	✓	✓	✓	✓	

¹ Not available on 9" wide.

² Not available on 9" or 24" (2 doors) wide.

³ Only available on 24" (2 doors) - 39" wide.

⁴ Not available on 9" or 12" wide.

⁵ Not available on 9", 12" or 39-48" wide and not available with end extended back left.

⁶ Not available on EXDNLRB.

⁷ Not available on 9" or 24" (2 doors) wide and fluting both not available on 27"-36" wide. Not available with 6" fluting.

⁸ FTKAV and style B-L not available on 9" or 12" wide.

⁹ Not available on 24" (1 door) or 48" wide.

¹⁰ Not available on 9" or 24" (2 doors) wide and fluting both not available on 27"-36" wide except with fluting both peninsula.

¹¹ TVRAV and style B-L not available on 9" or 12" wide.

Angled End Wall Cabinets

ANGLED END WALL CABINET SINGLE DOOR - 22 1/2° ANGLE

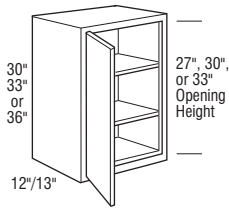

LL Shown

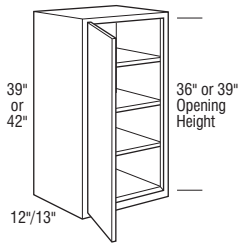

	Cubic Feet	1	2	3	4	5	6	7	
AEW2430LL	6.7	1127	1187	1220	1290	1367	1491	1615	
AEW2430RR	6.7	1127	1187	1220	1290	1367	1491	1615	
AEW2430LR	6.7	1127	1187	1220	1290	1367	1491	1615	
AEW2430RL	6.7	1127	1187	1220	1290	1367	1491	1615	
AEW2433LL	7.4	1351	1417	1466	1546	1637	1786	1935	
AEW2433RR	7.4	1351	1417	1466	1546	1637	1786	1935	
AEW2433LR	7.4	1351	1417	1466	1546	1637	1786	1935	
AEW2433RL	7.4	1351	1417	1466	1546	1637	1786	1935	
AEW2436LL	8.0	1436	1506	1560	1650	1746	1899	2052	
AEW2436RR	8.0	1436	1506	1560	1650	1746	1899	2052	
AEW2436LR	8.0	1436	1506	1560	1650	1746	1899	2052	
AEW2436RL	8.0	1436	1506	1560	1650	1746	1899	2052	
• Two adjustable shelves.									
AEW2439LL	8.7	1448	1519	1578	1661	1769	1926	2083	
AEW2439RR	8.7	1448	1519	1578	1661	1769	1926	2083	
AEW2439LR	8.7	1448	1519	1578	1661	1769	1926	2083	
AEW2439RL	8.7	1448	1519	1578	1661	1769	1926	2083	
AEW2442LL	9.3	1567	1644	1701	1794	1899	2074	2249	
AEW2442RR	9.3	1567	1644	1701	1794	1899	2074	2249	
AEW2442LR	9.3	1567	1644	1701	1794	1899	2074	2249	
AEW2442RL	9.3	1567	1644	1701	1794	1899	2074	2249	

- Three adjustable shelves.

Notes below apply to all products in section above:

- First letter denotes side of angle. Second letter denotes hinging of door.
- For use at the end of a run of wall cabinets.
- Front frame size is 5" (for 22 1/2°) less than overall width.
- Angle available on one side only.
- For AEW angled end, must specify end treatment of Finished End or Authentic End.
- Integral Ends, and Flush Panel Ends not available on Angled End.
- Increased Depths available in 3" increments to 15".
- Reduced Depths available in 3" increments to 9".

AEW-Angled End Wall Cabinets

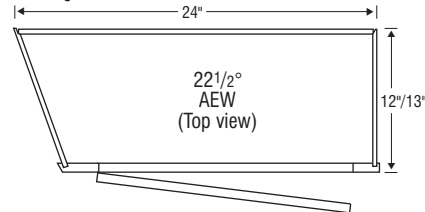

Door & Drawer Options

AF	AOMD	CC	CG	GAMD	HC	IFHG	MC	MD	MFO	PRMD	SHMD	SPLITDR	SPLITDRWS	TCG ¹	TCP ¹
✓			✓	✓	✓	✓	✓	✓	✓	✓	✓	✓	✓	✓	✓

End Panel Options

AUTH ²	CSFPE	EXBK	EXDN	FFD	FL/FR	FPE	INTGE	IPE
✓	✓	✓	✓		✓	✓	✓	✓

Custom Modification Options

ADD_SHLF	ADDTK	ADRW	BVR	CBO	CCO	CFNTO	CFRMO	CLIP	CND	CSDGBK	EX ³	EX_OL ⁴	F.ALL	FBFL	FLUT ⁵	FTK	ID	IH
	✓		✓	✓	✓	✓	✓	✓	✓	✓	✓	✓	✓	✓	✓	✓	✓	✓
INVERM	IW	LIGHT	MIP	OBRB	PFINBTMB	RD	RECTK	RH	ROSFLUT ⁶	RT	RW	STW	TD	TKP	TVR	WS	WTR	
	✓		✓	✓	✓	✓	✓	✓	✓	✓	✓	✓	✓	✓	✓	✓	✓	

¹ Not available on 30" or 33" high.

² Not available with authentic flush ends both.

³ Extended stile left not available on 36" or 39" wide.

⁴ Extended stile left not available on 36" or 39" wide. Not available with extended stile both.

⁵ Not available with fluting both or 6" fluting.

⁶ Not available with fluting both.

IH/RH availability charts starting on page G•40.
IW/RW availability charts starting on page G•46.

ANGLED END WALL CABINET SINGLE DOOR with FACE FRAME and DOOR on END – 22 1/2° ANGLE

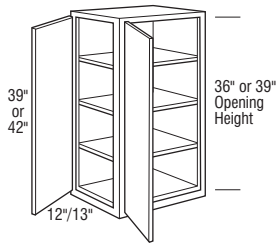
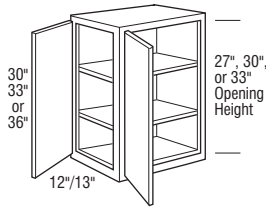

	Cubic Feet	1	2	3	4	5	6	7
AEWFFD2430LL	6.7	1532	1583	1628	1699	1771	1896	2021
AEWFFD2430RR	6.7	1532	1583	1628	1699	1771	1896	2021
AEWFFD2430LR	6.7	1532	1583	1628	1699	1771	1896	2021
AEWFFD2430RL	6.7	1532	1583	1628	1699	1771	1896	2021
AEWFFD2433LL	7.4	1759	1823	1872	1949	2037	2184	2331
AEWFFD2433RR	7.4	1759	1823	1872	1949	2037	2184	2331
AEWFFD2433LR	7.4	1759	1823	1872	1949	2037	2184	2331
AEWFFD2433RL	7.4	1759	1823	1872	1949	2037	2184	2331
AEWFFD2436LL	8.0	1838	1908	1961	2051	2149	2309	2469
AEWFFD2436RR	8.0	1838	1908	1961	2051	2149	2309	2469
AEWFFD2436LR	8.0	1838	1908	1961	2051	2149	2309	2469
AEWFFD2436RL	8.0	1838	1908	1961	2051	2149	2309	2469

• Two adjustable shelves.

AEWFFD2439LL	8.7	1853	1920	1984	2064	2172	2329	2486
AEWFFD2439RR	8.7	1853	1920	1984	2064	2172	2329	2486
AEWFFD2439LR	8.7	1853	1920	1984	2064	2172	2329	2486
AEWFFD2439RL	8.7	1853	1920	1984	2064	2172	2329	2486
AEWFFD2442LL	9.3	1990	2089	2161	2278	2416	2640	2864
AEWFFD2442RR	9.3	1990	2089	2161	2278	2416	2640	2864
AEWFFD2442LR	9.3	1990	2089	2161	2278	2416	2640	2864
AEWFFD2442RL	9.3	1990	2089	2161	2278	2416	2640	2864

• Three adjustable shelves.

Notes below apply to all products in section above:

- First letter denotes side of angle. Second letter denotes hinging of door.
- FFD door will be hinged same side as angle unless otherwise specified.
- For use at the end of a run of wall cabinets.
- Front frame size is 5" (for 22 1/2°) less than overall width.
- Angle available on one side only.
- Integral Ends, and Flush Panel Ends not available on Angled End.
- Increased Depths available in 3" increments to 15".
- Reduced Depths available in 3" increments to 9".
- When Inset or Beaded Inset is specified, the FFD door will be hinged on the back side.

AEW-Angled End Wall Cabinets with Frame

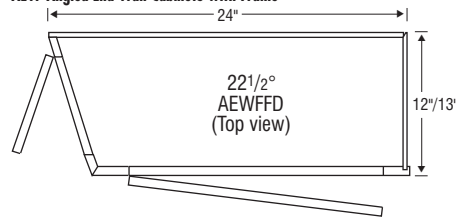

Door & Drawer Options

AF	AOMD	CC	CG	GAMD	HC	IFHG	MC	MD	MFO	PRMD	SHMD	SPLITDR	SPLITDRWS	TCG ¹	TCP ¹
✓		✓	✓			✓	✓	✓	✓	✓	✓			✓	✓

End Panel Options

AUTH ²	CSFPE	EXBK	EXDN	FFD	FL/FR	FPE	INTGE	IPE
✓	✓				✓	✓	✓	✓

Custom Modification Options

ADD	SHLF	ADDTK	ADRW	BVR	CBO	CCO	CFNTO	CFRMO	CLIP	CND	CSDGBK	EX	EX	OL ³	FALL	FBFL	FLUT ⁴	FTK	ID	IH
✓		✓							✓	✓	✓	✓	✓	✓	✓	✓	✓	✓	✓	✓

INVFRM	IW	LIGHT	MIP	OBRB	PFINBTMB	RD	RECTK	RH	ROSLUT ⁵	RT	RW	STW	TD	TKP	TVR	WS	WTR
			✓	✓	✓	✓	✓	✓	✓					✓	✓	✓	✓

¹ Not available with 30" or 33" high.

² Not available with authentic flush ends both.

³ Not available with extended stile both.

⁴ Not available with fluting both or 6" fluting.

⁵ Not available with fluting both.

Angled End Wall Cabinets

ANGLED END WALL CABINET DOUBLE DOOR – 22 1/2° ANGLE

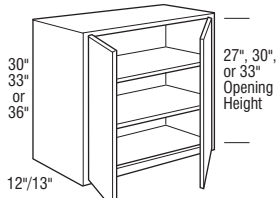

Left Angle Shown

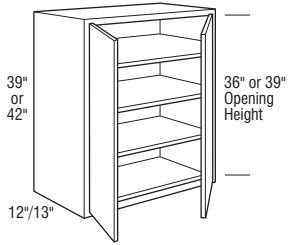

	Cubic Feet	1	2	3	4	5	6	7
AEW3630 L or R	9.9	1635	1712	1773	1869	1968	2149	2330
AEW3633 L or R	10.9	1829	1918	1984	2090	2203	2406	2609
AEW3636 L or R	11.8	1922	2014	2095	2207	2320	2530	2740

- Two adjustable shelves.

AEW3639 L or R	12.7	1944	2035	2117	2225	2341	2558	2775
AEW3642 L or R	13.7	1952	2051	2128	2240	2363	2581	2799

- Three adjustable shelves.

Notes below apply to all products in section above:

- Must specify L or R to designate a left or right angle.
- For use at the end of a run of wall cabinets.
- Front frame size is 5" (for 22 1/2°) less than overall width.
- Angle available on one side only.
- For AEW angled end, must specify end treatment of Finished End or Authentic End.
- Integral Ends, and Flush Panel Ends not available on Angled End.
- Increased Depths available in 3" increments to 15".
- Reduced Depths available in 3" increments to 9".

AEW-Angled End Wall Cabinets

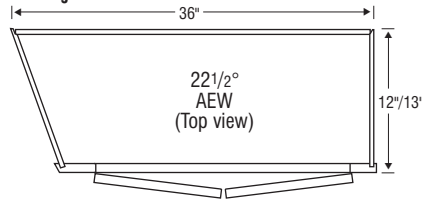

Door & Drawer Options

AF	AOMD	CC	CG	GAMD	HC	IFHG	MC	MD	MFO	PRMD	SHMD	SPLITDR	SPLITDRWS	TCG ¹	TCP ¹
✓			✓	✓				✓	✓	✓	✓	✓	✓	✓	✓

End Panel Options

AUTH ²	CSFPE	EXBK	EXDN	FFD	FL/FR	FPE	INTGE	IPE
✓	✓	✓	✓		✓	✓	✓	✓

Custom Modification Options

ADD	SHLF	ADTK	ADRW	BVR	CBO	CCO	CFNTO	CFRMO	CLIP	CND	CSDGBK	EX	EX_OL ³	FALL	FBFL	FLUT ⁴	FTK	ID	IH
✓	✓	✓	✓	✓	✓	✓	✓	✓	✓	✓	✓	✓	✓	✓	✓	✓	✓	✓	✓

INVFRM	IW	LIGHT	MIP	OBRB	PFINBTMB	RD	RECTK	RH	ROSLUT ⁵	RT	RW	STW	TD	TKP	TVR	WS	WTR
	✓		✓	✓	✓	✓	✓	✓	✓	✓	✓	✓	✓	✓	✓	✓	✓

¹ Not available on 30" or 33" high.

² Not available with authentic flush ends both.

³ Not available with extended stile both.

⁴ Not available with fluting both or 6" fluting.

⁵ Not available with fluting both.

IH/RH availability charts starting on page G•40.
IW/RW availability charts starting on page G•46.

ANGLED END WALL CABINET DOUBLE DOOR with FACE FRAME and DOOR on END – 22 1/2° ANGLE

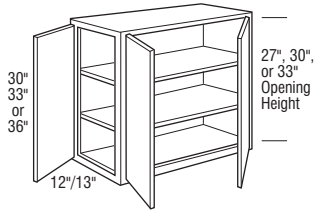

Left Angle Shown

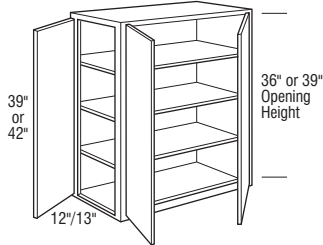

Cubic Feet	1	2	3	4	5	6	7	
AEWFFD3630 L or R	9.9	2038	2118	2177	2272	2372	2554	2736
AEWFFD3633 L or R	10.9	2241	2327	2396	2500	2610	2808	3006
AEWFFD3636 L or R	11.8	2326	2420	2501	2614	2724	2936	3148

- Two adjustable shelves.

AEWFFD3639 L or R	12.7	2361	2455	2530	2645	2764	2989	3214
AEWFFD3642 L or R	13.7	2481	2602	2692	2839	3008	3286	3564

- Three adjustable shelves.

Notes below apply to all products in section above:

- Must specify L or R to designate a left or right angle.
- FFD door will be hinged same side as angle unless otherwise specified.
- For use at the end of a run of wall cabinets.
- Front frame size is 5" (for 22 1/2°) less than overall width.
- Angle available on one side only.
- Integral Ends, and Flush Panel Ends not available on Angled End.
- Increased Depths available in 3" increments to 15".
- Reduced Depths available in 3" increments to 9".
- When Inset or Beaded Inset is specified, the FFD door will be hinged on the back side.

AEW-Angled End Wall Cabinets with Frame

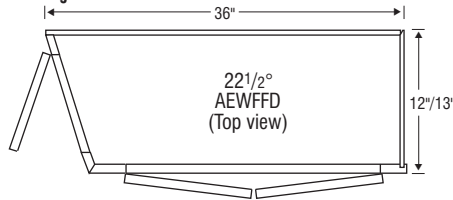

Door & Drawer Options

AF	AOMD	CC	CG	GAMD	HC	IFHG	MC	MD	MFO	PRMD	SHMD	SPLITDR	SPLITDRWS	TCG ¹	TCP ¹
✓			✓	✓		✓		✓	✓	✓	✓	✓		✓	✓

End Panel Options

AUTH ²	CSFPE	EXBK	EXDN	FFD	FL/FR	FPE	INTGE	IPE
✓	✓	✓		✓	✓	✓	✓	✓

Custom Modification Options

ADD_SHLF	ADDTK	ADRW	BVR	CBO	CCO	CFNTO	CFRMO	CLIP	CND	CSDGBK	EX	EX_OL ³	FALL	FBFL	FLUT ⁴	FTK	ID	IH
	✓			✓	✓	✓	✓		✓	✓	✓	✓	✓		✓	✓	✓	✓

INVFRM	IW	LIGHT	MIP	OBRB	PFINBTMB	RD	RECTK	RH	ROSLUT ⁵	RT	RW	STW	TD	TKP	TVR	WS	WTR
			✓	✓	✓	✓	✓	✓	✓					✓	✓	✓	✓

¹ Not available on 30" or 33" high.

² Not available with authentic flush ends both.

³ Extended stile left not available on 42" high. Not available with extended stile both.

⁴ Not available with fluting both or 6" fluting.

⁵ Not available with fluting both.

Angled End Wall Cabinets

ANGLED END WALL CABINET SINGLE DOOR - 45° ANGLE

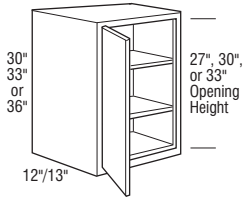

LL Shown

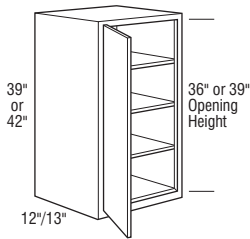

	Cubic Feet	1	2	3	4	5	6	7
AEW2430-45LL	6.7	1127	1187	1220	1290	1367	1491	1615
AEW2430-45RR	6.7	1127	1187	1220	1290	1367	1491	1615
AEW2430-45LR	6.7	1127	1187	1220	1290	1367	1491	1615
AEW2430-45RL	6.7	1127	1187	1220	1290	1367	1491	1615
AEW2433-45LL	7.4	1351	1417	1466	1546	1637	1786	1935
AEW2433-45RR	7.4	1351	1417	1466	1546	1637	1786	1935
AEW2433-45LR	7.4	1351	1417	1466	1546	1637	1786	1935
AEW2433-45RL	7.4	1351	1417	1466	1546	1637	1786	1935
AEW2436-45LL	8.0	1436	1506	1560	1650	1746	1899	2052
AEW2436-45RR	8.0	1436	1506	1560	1650	1746	1899	2052
AEW2436-45LR	8.0	1436	1506	1560	1650	1746	1899	2052
AEW2436-45RL	8.0	1436	1506	1560	1650	1746	1899	2052
• Two adjustable shelves.								
AEW2439-45LL	8.7	1448	1519	1578	1661	1769	1926	2083
AEW2439-45RR	8.7	1448	1519	1578	1661	1769	1926	2083
AEW2439-45LR	8.7	1448	1519	1578	1661	1769	1926	2083
AEW2439-45RL	8.7	1448	1519	1578	1661	1769	1926	2083
AEW2442-45LL	9.3	1567	1644	1701	1794	1899	2074	2249
AEW2442-45RR	9.3	1567	1644	1701	1794	1899	2074	2249
AEW2442-45LR	9.3	1567	1644	1701	1794	1899	2074	2249
AEW2442-45RL	9.3	1567	1644	1701	1794	1899	2074	2249

- Three adjustable shelves.

Notes below apply to all products in section above:

- First letter denotes side of angle. Second letter denotes hinging of door.
- For use at the end of a run of wall cabinets.
- Front frame size is 12" (for 45°) less than overall width.
- Angle available on one side only.
- For AEW angled end, must specify end treatment of Finished End or Authentic End.
- Integral Ends, and Flush Panel Ends not available on Angled End.
- Increased Depths available in 3" increments to 15".
- Reduced Depths available in 3" increments to 9".

AEW-Angled End Wall Cabinets

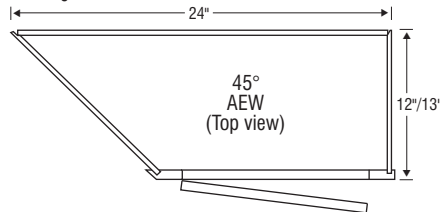

Door & Drawer Options

AF	AOMD	CC	CG	GAMD	HC	IFHG	MC	MD	MFO	PRMD	SHMD	SPLITDR	SPLITDRWS	TCG ¹	TCP ¹
✓		✓	✓	✓		✓		✓	✓		✓			✓	✓

End Panel Options

AUTH ²	CSFPE	EXBK	EXDN	FFD	FL/FR	FPE	INTGE	IPE
✓	✓	✓	✓	✓	✓	✓	✓	✓

Custom Modification Options

ADD	SHLF	ADDTK	ADRW	BVR	CBO	CCO	CFNTO	CFRMO	CLIP	CND	CSDGBK	EX	EX_OL ³	FALL	FBFL	FLUT ⁴	FTK	ID	IH	
	✓			✓	✓	✓	✓	✓		✓	✓	✓	✓	✓	✓	✓	✓	✓	✓	✓

INVRM	IW	LIGHT	MIP	OBRB	PFINBTMB	RD	RECTK	RH	ROSFLUT ⁵	RT	RW	STW	TD	TKP	TVR	WS	WTR
			✓	✓	✓	✓	✓	✓	✓					✓	✓	✓	✓

¹ Not available on 30" or 33" high.

² Not available with authentic flush ends both.

³ Not available with extended stiles both.

⁴ Not available with fluting both or 6" fluting.

⁵ Not available with fluting both.

IH/RH availability charts starting on page G•40.
IW/RW availability charts starting on page G•46.

ANGLED END WALL CABINET SINGLE DOOR with FACE FRAME and DOOR on END – 45° ANGLE

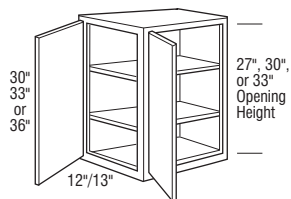

LL Shown

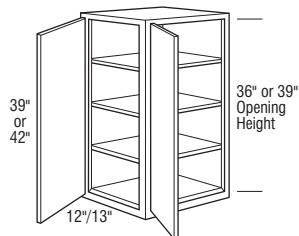

	Cubic Feet	1	2	3	4	5	6	7
AEWFFD2430-45LL	6.7	1532	1583	1628	1699	1771	1896	2021
AEWFFD2430-45RR	6.7	1532	1583	1628	1699	1771	1896	2021
AEWFFD2430-45LR	6.7	1532	1583	1628	1699	1771	1896	2021
AEWFFD2430-45RL	6.7	1532	1583	1628	1699	1771	1896	2021
AEWFFD2433-45LL	7.4	1759	1823	1872	1949	2037	2184	2331
AEWFFD2433-45RR	7.4	1759	1823	1872	1949	2037	2184	2331
AEWFFD2433-45LR	7.4	1759	1823	1872	1949	2037	2184	2331
AEWFFD2433-45RL	7.4	1759	1823	1872	1949	2037	2184	2331
AEWFFD2436-45LL	8.0	1838	1908	1961	2051	2149	2309	2469
AEWFFD2436-45RR	8.0	1838	1908	1961	2051	2149	2309	2469
AEWFFD2436-45LR	8.0	1838	1908	1961	2051	2149	2309	2469
AEWFFD2436-45RL	8.0	1838	1908	1961	2051	2149	2309	2469

• Two adjustable shelves.

AEWFFD2439-45LL	6.7	1853	1920	1984	2064	2172	2329	2486
AEWFFD2439-45RR	6.7	1853	1920	1984	2064	2172	2329	2486
AEWFFD2439-45LR	6.7	1853	1920	1984	2064	2172	2329	2486
AEWFFD2439-45RL	6.7	1853	1920	1984	2064	2172	2329	2486
AEWFFD2442-45LL	9.3	1990	2089	2161	2278	2416	2640	2864
AEWFFD2442-45RR	9.3	1990	2089	2161	2278	2416	2640	2864
AEWFFD2442-45LR	9.3	1990	2089	2161	2278	2416	2640	2864
AEWFFD2442-45RL	9.3	1990	2089	2161	2278	2416	2640	2864

• Three adjustable shelves.

Notes below apply to all products in section above:

- First letter denotes side of angle. Second letter denotes hinging of door.
- FFD door will be hinged same side as angle unless otherwise specified.
- For use at the end of a run of wall cabinets.
- Front frame size is 12" (for 45°) less than overall width.
- Angle available on one side only.
- Integral Ends, and Flush Panel Ends not available on Angled End.
- Increased Depths available in 3" increments to 15".
- Reduced Depths available in 3" increments to 9".
- When Inset or Beaded Inset is specified, the doors must both be hinged opposite of the angled end unless used in conjunction with a finial hinge.

AEW-Angled End Wall Cabinets with Frame

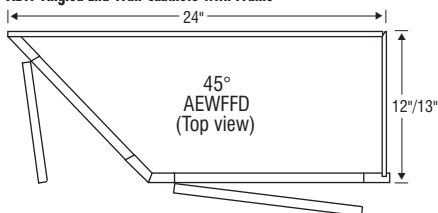

Door & Drawer Options

AF	AOMD	CC	CG	GAMD	HC	IFHG	MC	MD	MFO	PRMD	SHMD	SPLITDR	SPLITDRWS	TCG ¹	TCP ¹
✓	✓	✓	✓	✓	✓	✓	✓	✓	✓	✓	✓	✓	✓	✓	✓

End Panel Options

AUTH ²	CSFPE	EXBK	EXDN	FFD	FL/FR	FPE	INTGE	IPE
✓	✓	✓	✓	✓	✓	✓	✓	✓

Custom Modification Options

ADD	SHLF	ADDTK	ADRW	BVR	CBO	CCO	CFNTO	CFRMO	CLIP	CND	CSDGBK	EX	EX	OL ³	FALL	FBFL	FLUT ⁴	FTK	ID	IH
✓	✓	✓	✓	✓	✓	✓	✓	✓	✓	✓	✓	✓	✓	✓	✓	✓	✓	✓	✓	✓

INVFRM	IW	LIGHT	MIP	OBRB	PFINBTMB	RD	RECTK	RH	ROSLUT ⁵	RT	RW	STW	TD	TKP	TVR	WS	WTR
✓	✓	✓	✓	✓	✓	✓	✓	✓	✓	✓	✓	✓	✓	✓	✓	✓	✓

¹ Not available on 30" or 33" high.

² Not available with authentic flush ends both.

³ Not available with extended stiles both.

⁴ Not available with fluting both or 6" fluting.

⁵ Not available with fluting both.

Angled End Wall Cabinets

ANGLED END WALL CABINET DOUBLE DOOR – 45° ANGLE

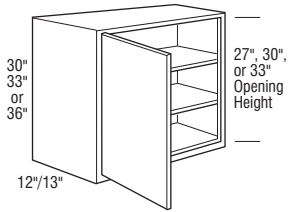

LL Shown

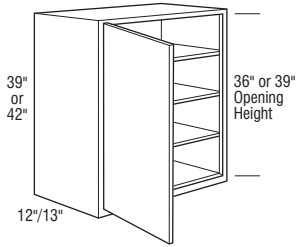

	Cubic Feet	1	2	3	4	5	6	7
AEW3630-45LL	9.9	1635	1712	1773	1869	1968	2149	2330
AEW3630-45RR	9.9	1635	1712	1773	1869	1968	2149	2330
AEW3630-45LR	9.9	1635	1712	1773	1869	1968	2149	2330
AEW3630-45RL	9.9	1635	1712	1773	1869	1968	2149	2330
AEW3633-45LL	10.9	1829	1918	1984	2090	2203	2406	2609
AEW3633-45RR	10.9	1829	1918	1984	2090	2203	2406	2609
AEW3633-45LR	10.9	1829	1918	1984	2090	2203	2406	2609
AEW3633-45RL	10.9	1829	1918	1984	2090	2203	2406	2609
AEW3636-45LL	11.8	1922	2014	2095	2207	2320	2530	2740
AEW3636-45RR	11.8	1922	2014	2095	2207	2320	2530	2740
AEW3636-45LR	11.8	1922	2014	2095	2207	2320	2530	2740
AEW3636-45RL	11.8	1922	2014	2095	2207	2320	2530	2740

• Two adjustable shelves.

AEW3639-45LL	12.7	1944	2035	2117	2225	2341	2558	2775
AEW3639-45RR	12.7	1944	2035	2117	2225	2341	2558	2775
AEW3639-45LR	12.7	1944	2035	2117	2225	2341	2558	2775
AEW3639-45RL	12.7	1944	2035	2117	2225	2341	2558	2775
AEW3642-45LL	13.7	1952	2051	2128	2240	2363	2581	2799
AEW3642-45RR	13.7	1952	2051	2128	2240	2363	2581	2799
AEW3642-45LR	13.7	1952	2051	2128	2240	2363	2581	2799
AEW3642-45RL	13.7	1952	2051	2128	2240	2363	2581	2799

• Three adjustable shelves.

Notes below apply to all products in section above:

- First letter denotes side of angle. Second letter denotes hinging of door.
- For use at the end of a run of wall cabinets.
- Front frame size is 12" (for 45°) less than overall width.
- Angle available on one side only.
- For AEW angled end, must specify end treatment of Finished End or Authentic End.
- Integral Ends, and Flush Panel Ends not available on Angled End.
- Increased Depths available in 3" increments to 15".
- Reduced Depths available in 3" increments to 9".

AEW-Angled End Wall Cabinets

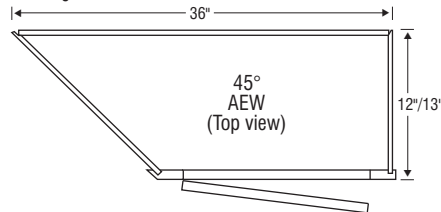

Door & Drawer Options

AF	AOMD	CC	CG	GAMD	HC	IFHG	MC	MD	MFO	PRMD ¹	SHMD	SPLITDR	SPLITDRWS	TCG ³	TCP ³
✓		✓	✓	✓		✓		✓	✓	✓	✓	✓	✓	✓	✓

End Panel Options

AUTH ²	CSFPE	EXBK	EXDN	FFD	FL/FR	FPE	INTGE	IPE
✓	✓	✓	✓	✓	✓	✓	✓	✓

Custom Modification Options

ADD	SHLF	ADDTK	ADRW	BVR	CBO	CCO	CFNTO	CFRMO	CLIP	CND	CSDGBK	EX	EX_OL ⁴	FALL	FBFL	FLUT ⁵	FTK	ID	IH	
	✓			✓	✓	✓	✓	✓	✓	✓	✓	✓	✓	✓	✓	✓	✓	✓	✓	✓

INVRM	IW	LIGHT	MIP	OBRB	PFINBTMB	RD	RECTK	RH	ROSFLUT ⁶	RT	RW	STW	TD	TKP	TVR	WS	WTR
			✓	✓	✓	✓	✓	✓	✓	✓	✓	✓	✓	✓	✓	✓	✓

¹ Not available on 33" or 39" high.

² Not available with authentic flush ends both.

³ Not available on 30" or 33" high.

⁴ Not available with extended stiles both.

⁵ Not available with fluting both or 6" fluting.

⁶ Not available with fluting both.

IH/RH availability charts starting on page G•40.
IW/RW availability charts starting on page G•46.

ANGLED END WALL CABINET DOUBLE DOOR with FACE FRAME and DOOR on END – 45° ANGLE

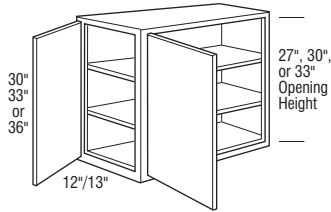

LL Shown

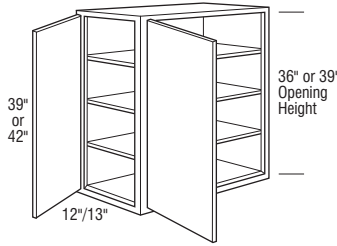

	Cubic Feet	1	2	3	4	5	6	7
AEWFFD3630-45LL	9.9	2038	2118	2177	2272	2372	2554	2736
AEWFFD3630-45RR	9.9	2038	2118	2177	2272	2372	2554	2736
AEWFFD3630-45LR	9.9	2038	2118	2177	2272	2372	2554	2736
AEWFFD3630-45RL	9.9	2038	2118	2177	2272	2372	2554	2736
AEWFFD3633-45LL	10.9	2241	2327	2396	2500	2610	2808	3006
AEWFFD3633-45RR	10.9	2241	2327	2396	2500	2610	2808	3006
AEWFFD3633-45LR	10.9	2241	2327	2396	2500	2610	2808	3006
AEWFFD3633-45RL	10.9	2241	2327	2396	2500	2610	2808	3006
AEWFFD3636-45LL	11.8	2326	2420	2501	2614	2724	2936	3148
AEWFFD3636-45RR	11.8	2326	2420	2501	2614	2724	2936	3148
AEWFFD3636-45LR	11.8	2326	2420	2501	2614	2724	2936	3148
AEWFFD3636-45RL	11.8	2326	2420	2501	2614	2724	2936	3148
• Two adjustable shelves.								
AEWFFD3639-45LL	12.7	2361	2455	2530	2645	2764	2989	3214
AEWFFD3639-45RR	12.7	2361	2455	2530	2645	2764	2989	3214
AEWFFD3639-45LR	12.7	2361	2455	2530	2645	2764	2989	3214
AEWFFD3639-45RL	12.7	2361	2455	2530	2645	2764	2989	3214
AEWFFD3642-45LL	13.7	2481	2602	2692	2839	3008	3286	3564
AEWFFD3642-45RR	13.7	2481	2602	2692	2839	3008	3286	3564
AEWFFD3642-45LR	13.7	2481	2602	2692	2839	3008	3286	3564
AEWFFD3642-45RL	13.7	2481	2602	2692	2839	3008	3286	3564

• Three adjustable shelves.

Notes below apply to all products in section above:

- First letter denotes side of angle. Second letter denotes hinging of door.
- FFD door will be hinged same side as angle unless otherwise specified.
- For use at the end of a run of wall cabinets.
- Front frame size is 12" (for 45°) less than overall width.
- Angle available on one side only.
- Integral Ends, and Flush Panel Ends not available on Angled End.
- Increased Depths available in 3" increments to 15".
- Reduced Depths available in 3" increments to 9".
- When Inset or Beaded Inset is specified, the doors must both be hinged opposite of the angled end unless used in conjunction with a finial hinge.

AEW-Angled End Wall Cabinets with Frame

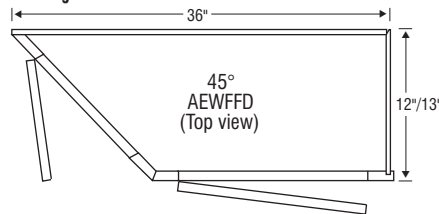

Door & Drawer Options

AF	AOMD	CC	GAMD	HC	IFHG	MC	MD	MFO	PRMD	SHMD	SPLITDR	SPLITDRWS	TCG ¹	TCP ¹
✓	✓	✓	✓	✓	✓	✓	✓	✓	✓	✓	✓	✓	✓	✓

End Panel Options

AUTH ²	CSFPE	EXBK	EXDN	FFD	FL/FR	FPE	INTGE	IPE
✓	✓	✓	✓	✓	✓	✓	✓	✓

Custom Modification Options

ADD	SHLF	ADDTK ³	ADRW	BVR	CBO	CCO	CFNTO	CFRMO	CLIP	CND	CSDGBK	EX	EX_OL ⁴	FALL	FBFL	FLUT ⁵	FTK	ID	IH
✓	✓	✓	✓	✓	✓	✓	✓	✓	✓	✓	✓	✓	✓	✓	✓	✓	✓	✓	✓

INVERM	IW	LIGHT	MIP	OBRB	PFINBTMB	RD	RECTK ⁶	RH	ROSFLUT ⁷	RT	RW	STW	TD	TKP ³	TVR	WS ⁸	WTR
✓	✓	✓	✓	✓	✓	✓	✓	✓	✓	✓	✓	✓	✓	✓	✓	✓	✓

¹ Not available on 30" or 33" high.

² Not available with authentic flush ends both.

³ Not available on 33" high.

⁴ Not available with extended stiles both.

⁵ Not available with fluting both or 6" fluting.

⁶ Recessed all ends not available on 33" high.

⁷ Not available with fluting both.

⁸ Only available on 33" high.

Wall End Cabinets

WALL END CABINET DOUBLE DOOR, 30", 33", 36", 39", 42", 45", or 48" HIGH

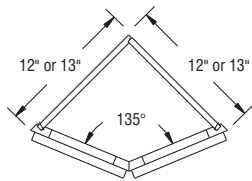
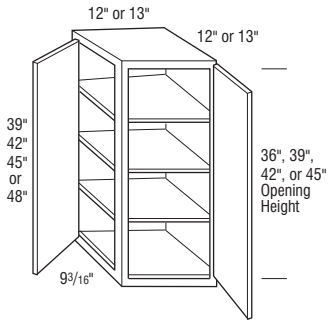
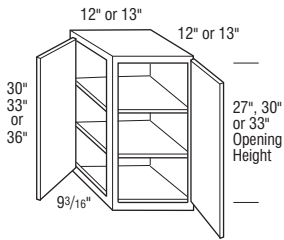

Top View

	Cubic Feet	1	2	3	4	5	6	7
WEC1230D	3.6	1680	1765	1822	1926	2021	2207	2393
WEC1233D	3.9	1768	1853	1914	2026	2123	2315	2507
WEC1236D	4.2	1807	1894	1960	2068	2172	2374	2576
WEC1239D	4.6	1862	1952	2020	2131	2239	2447	2655
WEC1242D	4.9	1860	1949	2015	2129	2272	2481	2690
WEC1245D	5.0	1875	1961	2029	2145	2284	2497	2710
WEC1248D	5.3	1888	1977	2045	2159	2300	2511	2722

• Reduced Heights available in 1/4" increments. See page G•40 for details.

• Two adjustable shelves.

• Three adjustable shelves

Notes below apply to all products in section above:

- Decorative Glass Door designs limited on this unit. See page H•18 for details.
- One 12" end/back may be ordered as finished.
- Finished End modification available on one side only. See page G•8 for details.
- Increased Depths available in 3" increments from 15" to 24".
- When used in conjunction with Inset or Beaded Inset, the hinge location will be changed on both doors to the center mullion.

Door & Drawer Options

AF	AQMD	CC	CG	GAMD	HC ¹	IFHG	MC ¹	MD	MFO	PRMD	SHMD	SPLITDR	SPLITDRWS	TCG ²	TCP ²
✓		✓		✓	✓	✓	✓	✓	✓		✓			✓	✓

End Panel Options

AUTH ³	CSFPE	EXBK ⁴	EXDN ⁵	FFD	FL/FR	FPE	INTGE	IPE
✓		✓	✓					

Custom Modification Options

ADD	SHLF	ADDTK	ADRW	BVR	CBO	CCO	CFNTO	CFRMO	CLIP	CND	CSDGBK	EX	EX_OL	F.ALL	FBFL	FLUT	FTK	ID	IH	
				✓	✓	✓	✓	✓	✓	✓	✓							✓	✓	✓

INVERM	IW	LIGHT	MIP	OBRB	PFINBTMB	RD	RECTK	RH ⁶	ROSFLUT	RT	RW	STW	TD	TKP	TVR ⁷	WS	WTR
				✓	✓	✓		✓							✓	✓	✓

¹ Only available on 36"-42" high.

² Not available on 30" or 33" high.

³ Not available with authentic flush ends both.

⁴ Not available on end extended back left.

⁵ Not available on EXDNLRB.

⁶ Only available on 30" high.

⁷ Only available on TVRVV.

IH/RH availability charts starting on page G•40.
IW/RW availability charts starting on page G•46.

WALL END CABINET SINGLE DOOR, 30", 33", 36", 39", 42", 45", or 48" HIGH

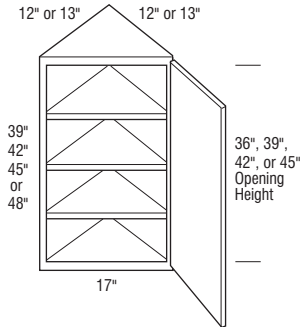
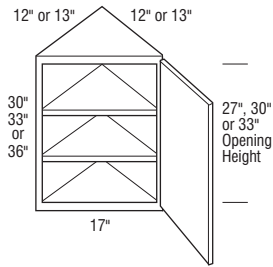

Cubic Feet	1	2	3	4	5	6	7	
WEC1230 L or R	3.6	1560	1636	1699	1785	1872	2051	2230
WEC1233 L or R	3.9	1653	1733	1796	1892	1984	2175	2366
WEC1236 L or R	4.2	1680	1765	1822	1926	2021	2207	2393
WEC1239 L or R	4.6	1688	1773	1828	1936	2033	2218	2403
WEC1242 L or R	4.9	1710	1789	1853	1954	2051	2245	2439
WEC1245 L or R	5.0	1725	1808	1870	1971	2068	2262	2456
WEC1248 L or R	5.3	1744	1824	1886	1987	2085	2278	2471

• Reduced Heights available in 1/4" increments. See page G•40 for details.

• Two adjustable shelves.

• Three adjustable shelves

Notes below apply to all products in section above:

- One 12" end/back may be ordered as finished.
- Finished End modification available on one side only. See page G•8 for details.
- Increased Depths available in 3" increments from 15" to 24".
- Only available in Inset and Beaded Inset when used in conjunction with a finial hinge.

Door & Drawer Options

AF	AOMD	CC	CG	GAMD	HC ¹	IFHG	MC ¹	MD	MFO	PRMD	SHMD	SPLITDR	SPLITDRWS	TCG ²	TCP ²
✓			✓	✓	✓	✓	✓	✓	✓	✓	✓			✓	✓

End Panel Options

AUTH	CSFPE	EXBK ³	EXDN ⁴	FFD	FL/FR	FPE	INTGE	IPE
		✓	✓		✓			

Custom Modification Options

ADD_SHLF	ADDTK	ADRW	BVR	CBO	CCO	CFNTO	CFRMO	CLIP	CND	CSDGBK	EX	EX_OL	FALL	FBFL	FLUT	FTK	ID	IH
			✓	✓	✓	✓	✓		✓	✓						✓	✓	✓
INVERM	IW	LIGHT	MIP	OBRB	PFINBTMB	RD	RECTK	RH ⁵	ROSLUT	RT	RW	STW	TD	TKP	TVR	WS	WTR	
	✓	✓	✓	✓	✓	✓	✓	✓							✓	✓	✓	

¹ Only available on 36"-42" high.

² Not available on 30" or 33" high.

³ Not available on end extended back left.

⁴ Not available on EXDNLRB.

⁵ Only available on 30" high.

135° Corner Wall Cabinets

135° CORNER OUTSIDE WALL, 30", 33", 36", 39", or 42" HIGH

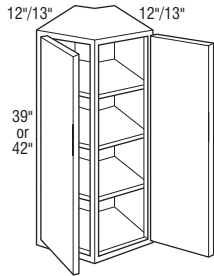
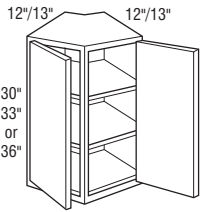

	Cubic Feet	1	2	3	4	5	6	7
W630COA	7.7	1939	1972	2080	2209	2298	2505	2712
W930COA	11.5	2132	2169	2287	2428	2528	2754	2980
W1230COA	15.0	2326	2366	2495	2651	2758	3004	3250
W633COA	8.4	2132	2169	2287	2428	2528	2754	2980
W933COA	12.6	2326	2366	2495	2651	2758	3004	3250
W1233COA	16.4	2521	2562	2704	2870	2988	3255	3522
W636COA	9.1	2326	2366	2495	2651	2758	3004	3250
W936COA	13.6	2521	2562	2704	2870	2988	3255	3522
W1236COA	17.7	2715	2761	2913	3091	3218	3504	3790
W639COA	9.8	2521	2562	2704	2870	2988	3255	3522
W939COA	14.7	2715	2761	2913	3091	3218	3504	3790
W1239COA	19.1	2909	2957	3120	3313	3448	3754	4060
W642COA	10.5	2715	2761	2913	3091	3218	3504	3790
W942COA	15.7	2909	2957	3120	3313	3448	3754	4060
W1242COA	20.5	3103	3154	3328	3533	3677	4004	4331

Notes below apply to all products in section above:

- Doors are hinged on outside of frame.
- Adjustable shelf cannot be removed from cabinet.
- No leg changes allowed.
- Reduced depths available in 3" increments to 9".
- Increased depths available in 13" deep, 15" deep, 18" deep, 21" deep, and 24" deep.

Model	A Dimension	B Dimension
W6(*)COA	6"	10 31/32"
W9(*)COA	9"	13 31/32"
W12(*)COA	12"	16 31/32"

A indicates back width of cabinet and wall space

B indicates face frame width

(*) indicates height of cabinet

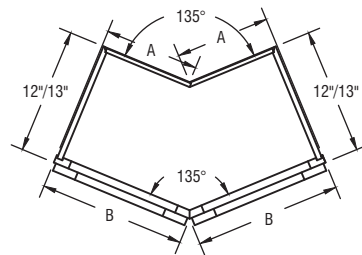

Top View

Door & Drawer Options

AF	AOMD	CC	CG	GAMD	HC	IFHG	MC	MD	MFO	PRMD	SHMD	SPLITDR	SPLITDRWS	TCG	TCP

End Panel Options

AUTH	CSFPE	EXBK	EXDN	FFD	FL/FR	FPE	INTGE	IPE

Custom Modification Options

ADD	SHLF	ADTK	ADRW	BVR	CBO	CCO	CFNTO	CFRMO	CLIP	CND	CSDGBK	EX	EX_OL ¹	FALL	FBFL	FLUT	FTK	ID	IH

INVFRM	IW	LIGHT	MIP	OBRB	PFINBTMB	RD	RECTK	RH	ROSFLUT	RT	RW	STW	TD	TKP	TVR	WS	WTR

¹ Not available with extended stiles both.

IH/RH availability charts starting on page G•40.
IW/RW availability charts starting on page G•46.

135° Corner Wall Cabinets

135° CORNER INSIDE WALL, 30", 33", 36", 39", or 42" HIGH

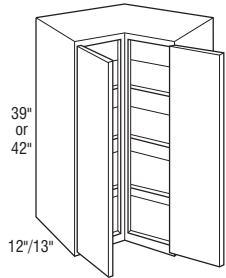
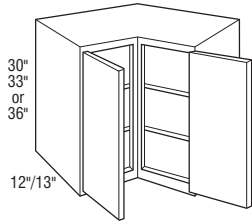

	Cubic Feet	1	2	3	4	5	6	7
W2130CIA	19.6	2521	2562	2704	2870	2988	3255	3522
W2430CIA	23.9	2715	2761	2913	3091	3218	3504	3790
W2730CIA	28.7	2909	2957	3120	3313	3448	3754	4060
W2133CIA	21.4	2715	2761	2913	3091	3218	3504	3790
W2433CIA	26.1	2909	2957	3120	3313	3448	3754	4060
W2733CIA	31.3	3103	3154	3328	3533	3677	4004	4331
W2136CIA	23.2	2909	2957	3120	3313	3448	3754	4060
W2436CIA	28.3	3103	3154	3328	3533	3677	4004	4331
W2736CIA	34.0	3296	3351	3536	3754	3907	4256	4605
W2139CIA	25.0	3103	3154	3328	3533	3677	4004	4331
W2439CIA	30.5	3296	3351	3536	3754	3907	4256	4605
W2739CIA	36.6	3490	3548	3743	3975	4137	4506	4875
W2142CIA	26.8	3296	3351	3536	3754	3907	4256	4605
W2442CIA	32.7	3490	3548	3743	3975	4137	4506	4875
W2742CIA	39.2	3684	3746	3951	4196	4368	4757	5146

Notes below apply to all products in section above:

- Doors are hinged on outside of frame.
- Adjustable shelf cannot be removed from cabinet.
- No leg changes allowed.
- Reduced depths available in 3" increments to 9".
- Increased depths available in 13" deep, 15" deep, 18" deep, 21" deep, and 24" deep.

Model	A Dimension	B Dimension
W21(*)CIA	21"	16 1/16"
W24(*)CIA	24"	19 1/16"
W27(*)CIA	27"	22 1/16"

A indicates back width of cabinet and wall space
 B indicates face frame width
 (*) indicates height of cabinet

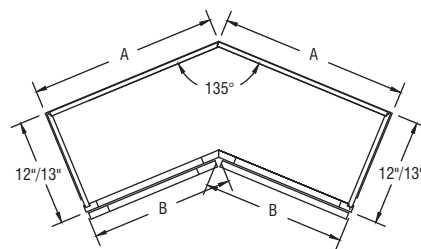

Top View

Door & Drawer Options

AF	AOMD	CC	CG	GAMD	HC	IFHG	MC	MD	MFO	PRMD	SHMD	SPLITDR	SPLITDRWS	TCG	TCP

End Panel Options

AUTH	CSFPE	EXBK	EXDN	FFD	FL/FR	FPE	INTGE	IPE

Custom Modification Options

ADD_SHLF	ADDTK	ADRW	BVR	CBO	CCO	CFNTO	CFRMO	CLIP	CND	CSDGBK	EX	EX_OL ¹	F.ALL	FBFL	FLUT ²	FTK	ID	IH

INVRM	IW	LIGHT	MIP	OBRB	PFINBTMB	RD	RECTK	RH	ROSLUT	RT	RW	STW	TD	TKP	TVR	WS	WTR

¹ Not available with extended stiles both.

² Not available with 6" fluting.

Wall Message Center

WALL MESSAGE CENTER, 3" WIDE, 30", 33", or 36" HIGH, 12" DEEP L O G I X

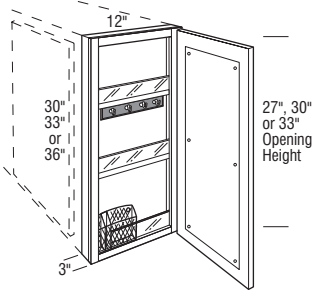

	Cubic Feet	1	2	3	4	5	6	7
WMC1230 L or R	1.4	1397	1464	1516	1598	1690	1849	2008
WMC1233 L or R	1.5	1560	1635	1690	1784	1888	2063	2238
WMC1236 L or R	1.6	1646	1725	1785	1882	1994	2179	2364

- Finished Flush Panel Ends standard.
- Two fixed shelves.
- Includes magnetic whiteboard on back of door, key hooks, pencil holder, and fixed plexi-glass fronted shelves.
- Door will open 90° without decorative hardware.
- Cabinet recommended to be hinged on wall side.
- For proper installation, adjacent cabinet must have flush ends or 3/32" skin applied.
- Embellishments or overlay fillers can be used on side of cabinet to add a decorative touch.
- Some modifications will require a Special Increased Depth option to be selected.
- Increased Depths available in 1/4" increments from 3 1/4" to 30".
- Not available on Inset and Beaded Inset styles.

Door & Drawer Options

AF	AOMD	CC	CG	GAMD	HC	IFHG	MC	MD	MFO	PRMD	SHMD	SPLITDR	SPLITDRWS	TCG	TCP

End Panel Options

AUTH ¹	CSFPE	EXBK	EXDN	FFD	FL/FR	FPE	INTGE	IPE
✓	✓	✓	✓	✓	✓	✓	✓	✓

Custom Modification Options

ADD_SHLF	ADDTK	ADRW	BVR	CBO	CCO	CFNTO	CFRMO	CLIP	CND	CSDGBK	EX	EX_OL	F.ALL	FBFL	FLUT ²	FTK ³	ID	IH

INVFRM	IW	LIGHT	MIP	OBRB	PFINBTMB	RD	RECTK	RH	ROSLUT	RT	RW	STW	TD	TKP	TVR	WS	WTR

¹ Not available with authentic flush ends both.

² Not available with 6" fluting.

³ Not available with FTKAV and style B-L.

WALL MESSAGE CENTER, 3" WIDE, 39" or 42" HIGH, 12" DEEP L O G I X

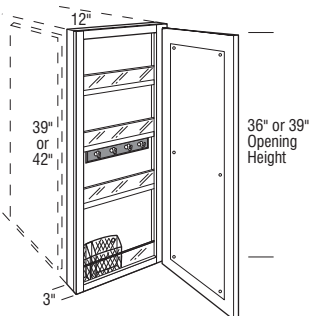

	1.7	1732	1816	1878	1983	2097	2291	2485
WMC1239 L or R								
WMC1242 L or R	1.9	1775	1859	1924	2030	2150	2348	2546

- Finished Flush Ends standard.
- Three fixed shelves.
- Includes magnetic whiteboard on back of door, key hooks, pencil holder, and fixed plexi-glass fronted shelves.
- Door will open 90° without decorative hardware.
- Cabinet recommended to be hinged on wall side.
- For proper installation, adjacent cabinet must have flush ends or 3/32" skin applied.
- Embellishments or overlay fillers can be used on side of cabinet to add a decorative touch.
- Some modifications will require a Special Increased Depth option to be selected.
- Increased Depths available in 1/4" increments from 3 1/4" to 30".
- Not available on Inset and Beaded Inset styles.

Door & Drawer Options

AF	AOMD	CC	CG	GAMD	HC	IFHG	MC	MD	MFO	PRMD	SHMD	SPLITDR	SPLITDRWS	TCG	TCP

End Panel Options

AUTH ¹	CSFPE	EXBK	EXDN	FFD	FL/FR	FPE	INTGE	IPE
✓	✓	✓	✓	✓	✓	✓	✓	✓

Custom Modification Options

ADD_SHLF	ADDTK	ADRW	BVR	CBO	CCO	CFNTO	CFRMO	CLIP	CND	CSDGBK	EX	EX_OL	F.ALL	FBFL	FLUT ²	FTK ³	ID	IH

INVFRM	IW	LIGHT	MIP	OBRB	PFINBTMB	RD	RECTK	RH	ROSLUT ⁴	RT	RW	STW	TD	TKP	TVR	WS	WTR

¹ Not available with authentic flush ends both.

² Not available on 42" high or with 6" fluting.

³ Not available with FTKAV and style B-L.

⁴ Not available on 42" high.

IH/RH availability charts starting on page G-40.
IW/RW availability charts starting on page G-46.

Wall Organizer & Floating Shelves

WALL ORGANIZER, 30", 33", or 36" WIDE, 9" HIGH

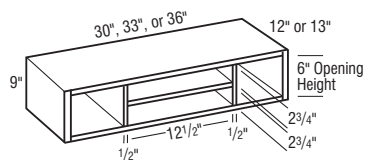

	Cubic Feet	1	2	3	4	5	6	7
WORG30	2.8	417	417	417	417	417	417	417
WORG33	3.0	438	438	438	438	438	438	438
WORG36	3.3	455	455	455	455	455	455	455

- Matching Interior standard.
- Inset and Beaded Inset Door Styles are a standard 13" deep.
- Increased Depths available in 3" increments from 15" to 24".
- Reduced Depths available in 3" increments from 6" to 9".

Door & Drawer Options

AF	AOMD	CC	CG	GAMD	HC	IFHG	MC	MD	MFO	PRMD	SHMD	SPLITDR	SPLITDRWS	TCG	TCP
----	------	----	----	------	----	------	----	----	-----	------	------	---------	-----------	-----	-----

End Panel Options

AUTH	CSFPE	EXBK	EXDN	FFD	FL/FR	FPE	INTGE	IPE
	✓	✓	✓				✓	

Custom Modification Options

ADD_SHLF	ADDTK	ADRW	BVR	CBO	CCO	CFNTD	CFRMO	CLIP	CND	CSDGBK	EX	EX_OL ¹	FALL	FBFL	FLUT ²	FTK	ID	IH
			✓				✓			✓	✓	✓			✓			✓

INVERM	IW	LIGHT	MIP	OBRB	PFINBTMB	RD	RECTK	RH	ROSLUT	RT	RW	STW	TD	TKP	TVR	WS	WTR
						✓			✓							✓	✓

¹ Not available with extended stiles both.

² Not available with 6" fluting.

FLOATING SHELF, 2 1/2" HIGH, 10" DEEP

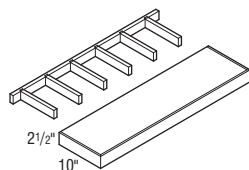

FS24	0.8	659	659	659	659	659	659	659
FS30	1.0	748	748	748	748	748	748	748
FS36	1.2	839	839	839	839	839	839	839
FS42	1.4	929	929	929	929	929	929	929
FS48	1.6	1017	1017	1017	1017	1017	1017	1017
FS54	1.8	1108	1108	1108	1108	1108	1108	1108
FS60	2.0	1198	1198	1198	1198	1198	1198	1198

- Shelf is finished on all sides except the back edges.
- Installation instructions included.
- Weight capacity is 15 lbs. per linear foot of width.
- Edge will be a #12 profile.
- Increased Depths available in 1/4" increments from 10 1/4" to 12".
- Reduced Depths available in 1/4" increments from 6" to 9 3/4".

Door & Drawer Options

AF	AOMD	CC	CG	GAMD	HC	IFHG	MC	MD	MFO	PRMD	SHMD	SPLITDR	SPLITDRWS	TCG	TCP
----	------	----	----	------	----	------	----	----	-----	------	------	---------	-----------	-----	-----

End Panel Options

AUTH	CSFPE	EXBK	EXDN	FFD	FL/FR	FPE	INTGE	IPE

Custom Modification Options

ADD_SHLF	ADDTK	ADRW	BVR	CBO	CCO	CFNTD	CFRMO	CLIP	CND	CSDGBK	EX	EX_OL	FALL	FBFL	FLUT	FTK	ID	IH
																		✓

INVERM	IW ¹	LIGHT	MIP	OBRB	PFINBTMB	RD	RECTK	RH	ROSLUT	RT	RW	STW	TD	TKP	TVR	WS	WTR	
	✓					✓												

¹ Not available on 60" wide.

Wall Organizer and Bookshelf & Wall Cabinet with Wine Rack

WALL ORGANIZER and BOOKSHELF, 36" HIGH L O G I X

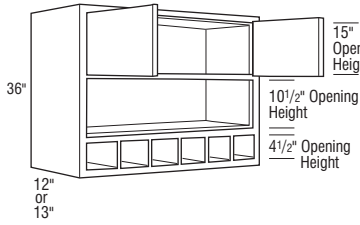

	Cubic Feet	1	2	3	4	5	6	7
WOB52436 (4 openings)	8.0	1881	1930	2000	2111	2224	2431	2638
WOB53036 (5 openings)	9.9	1958	2056	2128	2240	2363	2581	2799
WOB53636 (6 openings)	11.8	2156	2265	2340	2473	2607	2850	3093

- Matching Interior standard.
- Change of configuration in organizer section not available.
- Inset and Beaded Inset Door Styles are a standard 13" deep.
- Full Overlay Styles:
 - Increased Depths available in 1/4" increments from 12 1/4" to 30".
 - Reduced Depths available in 1/4" increments from 6" to 11 3/4".
- Inset and Beaded Inset Styles:
 - Increased Depths available in 1/4" increments from 13 1/4" to 30".
 - Reduced Depths available in 1/4" increments from 6" to 12 3/4".
- Increased Heights modification will increase the height of the upper cabinet section. The bottom section will retain its original height.

Door & Drawer Options

AF	AOMD	CC	CG	GAMD	HC	IFHG	MC	MD	MFO	PRMD ¹	SHMD	SPLITDR	SPLITDRWS	TCG	TCP
✓			✓	✓		✓		✓	✓	✓		✓			

End Panel Options

AUTH	CSFPE	EXBK	EXDN	FFD	FL/FR	FPE	INTGE	IPE
✓	✓	✓	✓		✓	✓		

Custom Modification Options

ADD	SHLF	ADTK	ADRW	BVR	CBO	CCO	CFNTO	CFRMO	CLIP	CND	CSDGBK	EX	EX_OL	F.ALL	FBFL	FLUT ²	FTK	ID	IH
✓			✓	✓	✓	✓	✓	✓		✓	✓	✓	✓	✓		✓	✓	✓	✓

INVFRM	IW	LIGHT	MIP	OBRB	PFINBTMB	RD	RECTK	RH	ROSLUT	RT	RW ¹	STW	TD	TKP	TVR	WS	WTR
	✓			✓	✓	✓			✓	✓	✓	✓	✓	✓	✓	✓	✓

- ¹ Not available on 24" wide.
² Not available with 6" fluting.
³ Not available on 24" or 36" wide.

WALL CABINET with WINE RACK, 30" HIGH L O G I X

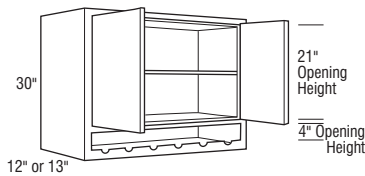

	Cubic Feet	1	2	3	4	5	6	7
WWR2430 (4 openings)	6.7	1807	1894	1949	2059	2150	2350	2550
WWR3030 (5 openings)	8.3	1846	1935	2004	2116	2195	2398	2601
WWR3630 (6 openings)	9.9	1984	2075	2145	2266	2406	2629	2852

- Matching Interior and Flush Bottom standard.
- One adjustable and one fixed shelf.
- Reveal under these models is less than the standard wall cabinet reveal. This may interfere with installation of cabinets/accessories to the bottom of the cabinet.
- Inset and Beaded Inset Door Styles are a standard 13" deep.
- Full Overlay Styles:
 - Increased Depths available in 1/4" increments from 12 1/4" to 30".
 - Reduced Depths available in 1/4" increments from 6" to 11 3/4".
- Inset and Beaded Inset Styles:
 - Increased Depths available in 1/4" increments from 13 1/4" to 30".
 - Reduced Depths available in 1/4" increments from 6" to 12 3/4".
- Increased Heights modification will increase the height of the upper cabinet section. The bottom section will retain its original height.

Door & Drawer Options

AF	AOMD	CC	CG	GAMD	HC	IFHG	MC	MD	MFO	PRMD ¹	SHMD	SPLITDR	SPLITDRWS	TCG	TCP
✓			✓	✓		✓		✓	✓	✓		✓			

End Panel Options

AUTH	CSFPE	EXBK	EXDN	FFD	FL/FR	FPE	INTGE	IPE
✓	✓	✓	✓		✓	✓		

Custom Modification Options

ADD	SHLF	ADTK	ADRW	BVR	CBO	CCO	CFNTO	CFRMO	CLIP	CND	CSDGBK	EX	EX_OL	F.ALL	FBFL	FLUT ²	FTK	ID	IH
✓			✓	✓	✓	✓	✓	✓		✓	✓	✓	✓	✓		✓	✓	✓	✓

INVFRM	IW	LIGHT	MIP	OBRB	PFINBTMB	RD	RECTK	RH	ROSLUT ³	RT	RW	STW	TD	TKP	TVR	WS	WTR
	✓			✓	✓	✓			✓	✓	✓	✓	✓	✓	✓	✓	✓

- ¹ Not available on 24" wide.
² Not available with fluting both or 6" fluting.
³ Not available with fluting both.

IH/RH availability charts starting on page G•40.
 IW/RW availability charts starting on page G•46.

WALL WINE RACK, 15", 18", 30", or 36" HIGH

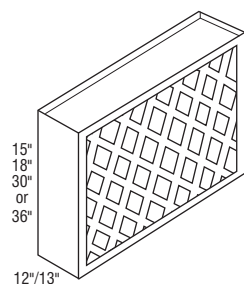

	Cubic Feet	1	2	3	4	5	6	7
WNR3015	4.4	910	910	910	910	910	910	910
WNR3315	4.8	1000	1000	1000	1000	1000	1000	1000
WNR3615	5.2	1091	1091	1091	1091	1091	1091	1091
WNR3018	5.2	1091	1091	1091	1091	1091	1091	1091
WNR3318	5.6	1202	1202	1202	1202	1202	1202	1202
WNR3618	6.1	1310	1310	1310	1310	1310	1310	1310
WNR1530	4.4	1036	1036	1036	1036	1036	1036	1036
WNR1830	5.2	1091	1091	1091	1091	1091	1091	1091
WNR2130	5.9	1273	1273	1273	1273	1273	1273	1273
WNR2430	6.7	1454	1454	1454	1454	1454	1454	1454
WNR3630	9.9	2181	2181	2181	2181	2181	2181	2181
WNR1836	6.1	1310	1310	1310	1310	1310	1310	1310
WNR2436	8.0	1746	1746	1746	1746	1746	1746	1746

- Matching Interior standard.
- Size of openings is 4"W x 4"H; number of openings varies with size of unit.
- Inset and Beaded Inset Door Styles are a standard 13" deep.
- If ordered with Hewn Technique, will not feature sand-through characteristics.

Model	Sections
WNR3015	10
WNR3315	14
WNR3615	14
WNR3018	10
WNR3318	14
WNR3618	14
WNR1530	10
WNR1830	10
WNR2130	18
WNR2430	18
WNR3630	32
WNR1836	14
WNR2436	22

Door & Drawer Options

AF	AOMD	CC	CG	GAMD	HC	IFHG	MC	MD	MFO	PRMD	SHMD	SPLITDR	SPLITDRWS	TCG	TCP
----	------	----	----	------	----	------	----	----	-----	------	------	---------	-----------	-----	-----

End Panel Options

AUTH	CSFPE	EXBK	EXDN	FFD	FL/FR	FPE	INTGE	IPE
✓	✓	✓	✓	✓	✓	✓	✓	✓

Custom Modification Options

ADD_SHLF	ADDTK	ADRW	BVR	CBO	CCO	CFNTO	CFRMO	CLIP	CND	CSDGBK	EX	EX_OL	FALL	FBFL	FLUT ¹	FTK	ID	IH
	✓	✓								✓	✓	✓			✓	✓		
INVFRM	IW	LIGHT	MIP	OBRB	PFINBTMB	RD	RECTK	RH	ROSLUT	RT	RW	STW	TD	TKP	TVR	WS	WTR	
				✓		✓			✓							✓	✓	

¹ Not available with 6" fluting.

Wall Wine Storage Cabinets

	Cubic Feet	1	2	3	4	5	6	7
WALL WINE STORAGE CABINET, 12", 15", 18", 21", or 24" HIGH	WSC121212 L or R	1.5	905	905	905	905	905	905
	WSC151512 L or R	2.2	980	980	980	980	980	980
• Specify L or R angle.								
	WSC121212	1.5	945	945	945	945	945	945
	WSC151512	2.2	1020	1020	1020	1020	1020	1020
	WSC181812	3.1	1039	1039	1039	1039	1039	1039
	WSC212112	4.2	1139	1139	1139	1139	1139	1139
	WSC242412	5.3	1210	1210	1210	1210	1210	1210
WSC181818								
		4.3	1185	1185	1185	1185	1185	1185

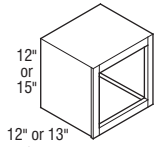

(Left Shown)

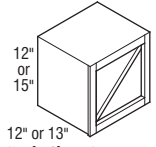

(Right Shown)

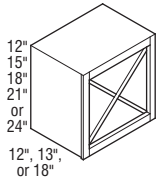

Notes below apply to all products in section above:

- Matching Interior standard.
- Wine bottle quantities based on a wine bottle diameter of 3 1/2".
- Inset and Beaded Inset Door Styles are a standard 13" deep.
- "X" shelf configuration cannot be removed.
- If ordered with Heirloom Technique, will not feature sand-through characteristics.
- Full Overlay Styles:
 - Increased Depths available in 1/4" increments from 12 1/4" to 18".
- Inset and Beaded Inset Styles:
 - Increased Depths available in 1/4" increments from 13 1/4" to 18".
 - Reduced Depths available in 1/4" increments from 12" to 12 3/4".

Model	# Openings	# Wine Bottles
WSC121212 L or R	2	4
WSC151512 L or R	2	9
WSC121212	4	4
WSC151512	4	6
WSC181812	4	12
WSC212112	4	16
WSC242412	4	24
WSC181818	4	12

Door & Drawer Options

AF	AOMD	CC	CG	GAMD	HC	IFHG	MC	MD	MFO	PRMD	SHMD	SPLITDR	SPLITDRWS	TCG	TCP
----	------	----	----	------	----	------	----	----	-----	------	------	---------	-----------	-----	-----

End Panel Options

AUTH	CSFPE	EXBK	EXDN	FFD	FL/FR	FPE	INTGE	IPE
✓	✓	✓	✓	✓	✓	✓		

Custom Modification Options

ADD	SHLF	ADDTK	ADRW	BVR	CBO	CCO	CFNTO	CFRMO	CLIP	CND	CSDGBK	EX	EX_OL	F.ALL	FBFL	FLUT ¹	FTK	ID ²	IH
				✓							✓	✓	✓			✓	✓	✓	
INVRM	IW	LIGHT	MIP	OBRB	PFINBTAB	RD	RECTK	RH	ROSLUT ³	RT	RW	STW	TD	TKP	TVR	WS	WTR		
				✓	✓				✓							✓	✓		

¹ Not available with fluting both or 6" fluting.

² Not available on 18" deep.

³ Not available with fluting both.

IH/RH availability charts starting on page G•40.
IW/RW availability charts starting on page G•46.

WALL CHINA DISPLAY, 15" HIGH

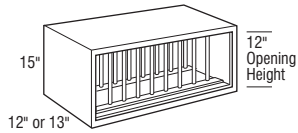

Model	# of Plates
WCD2415	8
WCD3015	10
WCD3615	12

	Cubic Feet	1	2	3	4	5	6	7
WCD2415	3.5	1653	1653	1653	1653	1653	1653	1653
WCD3015	4.4	1785	1785	1785	1785	1785	1785	1785
WCD3615	5.2	1901	1901	1901	1901	1901	1901	1901

- Matching Interior standard.
- Not available built as one unit with other wall cabinets.
- Inset and Beaded Inset Door Styles are a standard 13" deep.
- Full Overlay Styles:
 - Increased Depths available in 1/4" increments from 12 1/4" to 30".
 - Reduced Depths available in 1/4" increments from 6" to 11 3/4".
- Inset and Beaded Inset Styles:
 - Increased Depths available in 1/4" increments from 13 1/4" to 30".
 - Reduced Depths available in 1/4" increments from 6" to 12 3/4".

Door & Drawer Options

AF	AOMD	CC	CG	GAMD	HC	IFHG	MC	MD	MFO	PRMD	SHMD	SPLITDR	SPLITDRWS	TCG	TCP
----	------	----	----	------	----	------	----	----	-----	------	------	---------	-----------	-----	-----

End Panel Options

AUTH	CSFPE	EXBK	EXDN	FFD	FL/FR	FPE	INTGE	IPE
✓	✓	✓	✓	✓	✓	✓	✓	✓

Custom Modification Options

ADD	SHLF	ADDTK	ADRW	BVR	CBO	CCO	CFNTO	CFRMO	CLIP	CND	CSDGBK	EX	EX_OL	FALL	FBFL	FLUT ¹	FTK	ID	IH
			✓	✓							✓	✓	✓			✓	✓	✓	✓
INVERM	IW	LIGHT	MIP	OBRB	PFINBTMB	RD	RECTK	RH	ROSELUT	RT	RW ²	STW	TD	TKP	TVR	WS	WTR		
				✓	✓	✓			✓		✓					✓	✓		

¹ Not available with 6" fluting.

² Not available on 24" wide.

Wine Cubes

WINE CUBE HORIZONTAL, 6" HIGH

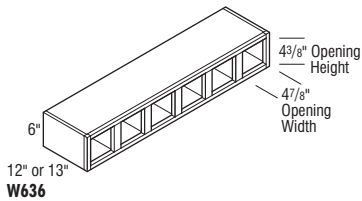

	Cubic Feet	1	2	3	4	5	6	7
W618 (3 openings)	1.2	523	523	523	523	523	523	523
W624 (4 openings)	1.6	606	606	606	606	606	606	606
W630 (5 openings)	1.9	695	695	695	695	695	695	695
W636 (6 openings)	2.3	777	777	777	777	777	777	777
W642 (7 openings)	2.7	869	869	869	869	869	869	869

- Available as separate unit only.
- Inset Door Styles are standard 13" deep. Beaded Inset not available.
- Increased Depths available in 1/4" increments from 12 1/4" to 24".
- Matching Interior, Finished Ends, and Flush Panel Ends are standard.

Door & Drawer Options

AF	AOMD	CC	CG	GAMD	HC	IFHG	MC	MD	MFO	PRMD	SHMD	SPLITDR	SPLITDRWS	TCG	TCP
----	------	----	----	------	----	------	----	----	-----	------	------	---------	-----------	-----	-----

End Panel Options

AUTH	CSFPE	EXBK	EXDN	FFD	FL/FR	FPE	INTGE	IPE
------	-------	------	------	-----	-------	-----	-------	-----

Custom Modification Options

ADD	SHLF	ADTK	ADRW	BVR	CBO	CCO	CFNTO	CFRMO	CLIP	CND	CSDGBK	EX	EX_OL	F.ALL	FBFL	FLUT	FTK	ID	IH
-----	------	------	------	-----	-----	-----	-------	-------	------	-----	--------	----	-------	-------	------	------	-----	----	----

INVFRM	IW	LIGHT	MIP	OBRB	PFINBTMB	RD	RECTK	RH	ROSLUT	RT	RW	STW	TD	TKP	TVR	WS	WTR
--------	----	-------	-----	------	----------	----	-------	----	--------	----	----	-----	----	-----	-----	----	-----

WINE CUBE VERTICAL, 6" WIDE

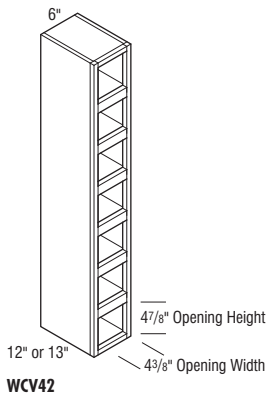

	Cubic Feet	1	2	3	4	5	6	7
WCV18 (3 openings)	1.2	523	523	523	523	523	523	523
WCV24 (4 openings)	1.6	606	606	606	606	606	606	606
WCV30 (5 openings)	1.9	695	695	695	695	695	695	695
WCV36 (6 openings)	2.3	777	777	777	777	777	777	777
WCV42 (7 openings)	2.7	869	869	869	869	869	869	869

Notes below apply to all products in section above:

- Available as separate unit only.
- Inset Door Styles are standard 13" deep. Beaded Inset not available.
- Matching Interior standard.
- Finished or Flush Panel Ends must be specified if required.

Door & Drawer Options

AF	AOMD	CC	CG	GAMD	HC	IFHG	MC	MD	MFO	PRMD	SHMD	SPLITDR	SPLITDRWS	TCG	TCP
----	------	----	----	------	----	------	----	----	-----	------	------	---------	-----------	-----	-----

End Panel Options

AUTH	CSFPE	EXBK	EXDN	FFD	FL/FR	FPE	INTGE	IPE
------	-------	------	------	-----	-------	-----	-------	-----

Custom Modification Options

ADD	SHLF	ADTK	ADRW	BVR	CBO	CCO	CFNTO	CFRMO	CLIP	CND	CSDGBK	EX	EX_OL	F.ALL	FBFL	FLUT	FTK	ID	IH
-----	------	------	------	-----	-----	-----	-------	-------	------	-----	--------	----	-------	-------	------	------	-----	----	----

INVFRM	IW	LIGHT	MIP	OBRB	PFINBTMB	RD	RECTK	RH	ROSLUT	RT	RW	STW	TD	TKP	TVR	WS	WTR
--------	----	-------	-----	------	----------	----	-------	----	--------	----	----	-----	----	-----	-----	----	-----

IH/RH availability charts starting on page G-40.
IW/RW availability charts starting on page G-46.

WALL SPICE DRAWER HORIZONTAL, 6" HIGH

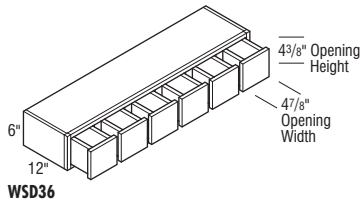

	Cubic Feet	1	2	3	4	5	6	7
WSD18 (3 drawers)	1.2	880	880	880	880	880	880	880
WSD24 (4 drawers)	1.6	1086	1086	1086	1086	1086	1086	1086
WSD30 (5 drawers)	1.9	1299	1299	1299	1299	1299	1299	1299
WSD36 (6 drawers)	2.3	1506	1506	1506	1506	1506	1506	1506
WSD42 (7 drawers)	2.7	1712	1712	1712	1712	1712	1712	1712

- Matching Interior, Finished Ends, and Flush Panel Ends are standard.
- Not available on Inset and Beaded Inset styles.

Door & Drawer Options

AF	AOMD	CC	CG	GAMD	HC	IFHG	MC	MD	MFO	PRMD	SHMD	SPLITDR	SPLITDRWS	TCG	TCP
----	------	----	----	------	----	------	----	----	-----	------	------	---------	-----------	-----	-----

End Panel Options

AUTH	CSFPE	EXBK ¹	EXDN	FFD	FL/FR	FPE	INTGE	IPE
------	-------	-------------------	------	-----	-------	-----	-------	-----

Custom Modification Options

ADD_SHLF	ADDTK	ADRW	BVR	CBO	CCO	CFNTO	CFRMO	CLIP	CND	CSDGBK	EX	EX_OL	FALL	FBFL	FLUT	FTK	ID	IH
----------	-------	------	-----	-----	-----	-------	-------	------	-----	--------	----	-------	------	------	------	-----	----	----

INVERM	IW	LIGHT	MIP	OBRB	PFINBTMB	RD	RECTK	RH	ROSLUT	RT	RW ²	STW	TD	TKP	TVR	WS	WTR
--------	----	-------	-----	------	----------	----	-------	----	--------	----	-----------------	-----	----	-----	-----	----	-----

¹ Not available on end extended back left.

² Only available on 18" wide.

WALL SPICE DRAWER VERTICAL, 6" WIDE

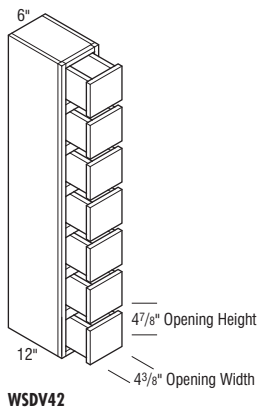

	Cubic Feet	1	2	3	4	5	6	7
WSDV18 (3 drawers)	1.2	880	880	880	880	880	880	880
WSDV24 (4 drawers)	1.6	1086	1086	1086	1086	1086	1086	1086
WSDV30 (5 drawers)	1.9	1299	1299	1299	1299	1299	1299	1299
WSDV36 (6 drawers)	2.3	1506	1506	1506	1506	1506	1506	1506
WSDV42 (7 drawers)	2.7	1712	1712	1712	1712	1712	1712	1712

- Reduced Heights available in 6" increments to 12".

Notes below apply to all products in section above:

- Not available on Inset and Beaded Inset styles.
- Matching Interior standard.
- Finished or Flush Panel Ends must be specified if required.

Door & Drawer Options

AF	AOMD	CC	CG	GAMD	HC	IFHG	MC	MD	MFO	PRMD	SHMD	SPLITDR	SPLITDRWS	TCG	TCP
----	------	----	----	------	----	------	----	----	-----	------	------	---------	-----------	-----	-----

End Panel Options

AUTH	CSFPE	EXBK ¹	EXDN	FFD	FL/FR	FPE	INTGE	IPE
------	-------	-------------------	------	-----	-------	-----	-------	-----

Custom Modification Options

ADD_SHLF	ADDTK	ADRW	BVR	CBO	CCO	CFNTO	CFRMO	CLIP	CND	CSDGBK	EX	EX_OL	FALL	FBFL	FLUT	FTK	ID	IH
----------	-------	------	-----	-----	-----	-------	-------	------	-----	--------	----	-------	------	------	------	-----	----	----

INVERM	IW	LIGHT	MIP	OBRB	PFINBTMB	RD	RECTK	RH	ROSLUT	RT	RW	STW	TD	TKP	TVR	WS	WTR
--------	----	-------	-----	------	----------	----	-------	----	--------	----	----	-----	----	-----	-----	----	-----

¹ Not available on end extended back left.

Wall Quarter Round End Shelves

WALL QUARTER ROUND END SHELF, 30", 33", 36", 39", 42", 45", or 48" HIGH

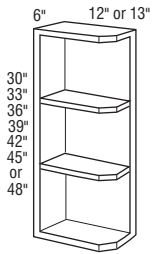

WQRES630RT
(Left angle shown)

	Cubic Feet	1	2	3	4	5	6	7	
WQRES630RT	2.0	865	865	865	865	865	865	865	
<ul style="list-style-type: none"> • Four fixed shelves including top/bottom. • Reduced Heights available in 1/4" increments from 18" to 29 3/4". • Increased Heights available in 1/4" increments from 30 1/4" to 32 3/4". 									
WQRES633RT	2.2	913	913	913	913	913	913	913	
<ul style="list-style-type: none"> • Four fixed shelves including top/bottom. • Increased Heights available in 1/4" increments from 33 1/4" to 35 3/4". 									
WQRES636RT	2.4	962	962	962	962	962	962	962	
<ul style="list-style-type: none"> • Four fixed shelves including top/bottom. • Increased Heights available in 1/4" increments from 36 1/4" to 38 3/4". 									
WQRES639RT	2.6	1011	1011	1011	1011	1011	1011	1011	
<ul style="list-style-type: none"> • Four fixed shelves including top/bottom. • Increased Heights available in 1/4" increments from 39 1/4" to 44 3/4". 									
WQRES642RT	2.7	1060	1060	1060	1060	1060	1060	1060	
<ul style="list-style-type: none"> • Five fixed shelves including top/bottom. • Increased Heights available in 1/4" increments from 42 1/4" to 47 3/4". 									
WQRES645RT	3.0	1108	1108	1108	1108	1108	1108	1108	
<ul style="list-style-type: none"> • Five fixed shelves including top/bottom. • Increased Heights available in 1/4" increments from 45 1/4" to 47 3/4". 									
WQRES648RT	3.2	1158	1158	1158	1158	1158	1158	1158	
<ul style="list-style-type: none"> • Five fixed shelves including top/bottom. 									

Notes below apply to all products in section above:

- 3/4" thick back and side.
- Inset and Beaded Inset Door Styles are a standard 13" deep.
- Increased Depths available in 1/4" increments to 18".
- Reduced Depths available in 1/4" increments to 9".

Door & Drawer Options

AF	AOMD	CC	CG	GAMD	HC	IFHG	MC	MD	MFO	PRMD	SHMD	SPLITDR	SPLITDRWS	TCG	TCP
----	------	----	----	------	----	------	----	----	-----	------	------	---------	-----------	-----	-----

End Panel Options

AUTH	CSFPE	EXBK	EXDN	FFD	FL/FR	FPE	INTGE	IPE
------	-------	------	------	-----	-------	-----	-------	-----

Custom Modification Options

ADD_SHLF	ADDTK	ADRW	BVR	CBO	CCO	CFNTO	CFRMO	CLIP	CND	CSDGBK	EX	EX_OL	F.ALL	FBFL	FLUT	FTK	ID	IH ¹
INVRM	IW	LIGHT	MIP	OBRB	PFINBTMB	RD	RECTK	RH ²	ROSFLUT	RT	RW	STW	TD	TKP	TVR	WS	WTR	

¹ Not available on 48" high.

² Only available on 30" high.

IH/RH availability charts starting on page G-40.
IW/RW availability charts starting on page G-46.

Wall Quarter Round End Shelves

WALL QUARTER ROUND END SHELF, SQUARE TOP and CLIPPED BOTTOM SHELVES, 30", 33", 36", 39", 42", 45", or 48" HIGH

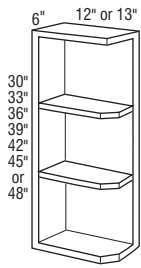

	Cubic Feet	1	2	3	4	5	6	7
WQRES630ST L or R	2.0	910	910	910	910	910	910	910
WQRES633ST L or R	2.2	960	960	960	960	960	960	960
WQRES636ST L or R	2.4	1008	1008	1008	1008	1008	1008	1008
WQRES639ST L or R	2.6	1057	1057	1057	1057	1057	1057	1057
WQRES642ST L or R	2.7	1105	1105	1105	1105	1105	1105	1105
WQRES645ST L or R	3.0	1153	1153	1153	1153	1153	1153	1153
WQRES648ST L or R	3.2	1202	1202	1202	1202	1202	1202	1202

- L or R denotes square top placement.
- 30", 33", and 36" high have four fixed shelves including top/bottom.
- 39", 42", 45", and 48" high have five fixed shelves including top/bottom.
- 3/4" thick back and side.
- Solid-wood construction.

Door & Drawer Options

AF	AOMD	CC	CG	GAMD	HC	IFHG	MC	MD	MFO	PRMD	SHMD	SPLITDR	SPLITDRWS	TCG	TCP
----	------	----	----	------	----	------	----	----	-----	------	------	---------	-----------	-----	-----

End Panel Options

AUTH	CSFPE	EXBK	EXDN	FFD	FL/FR	FPE	INTGE	IPE
------	-------	------	------	-----	-------	-----	-------	-----

Custom Modification Options

ADD_SHLF	ADDTK	ADRW	BVR	CBO	CCO	CFNTO	CFRMO	CLIP	CND	CSDGBK	EX	EX_OL	FALL	FBFL	FLUT	FTK	ID	IH ¹
----------	-------	------	-----	-----	-----	-------	-------	------	-----	--------	----	-------	------	------	------	-----	----	-----------------

INVERM	IW	LIGHT	MIP	OBRB	PFINBTMB	RD	RECTK	RH ²	ROSLUT	RT	RW	STW	TD	TKP	TVR	WS	WTR
--------	----	-------	-----	------	----------	----	-------	-----------------	--------	----	----	-----	----	-----	-----	----	-----

¹ Not available on 48" high.

² Only available on 30" high.

WALL QUARTER ROUND END SHELF, SQUARE SHELVES, 30", 33", 36", 39", 42", 45", or 48" HIGH

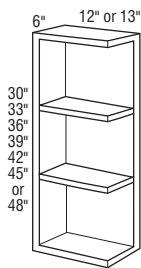

WQRES630STSB	2.0	910	910	910	910	910	910	910
WQRES633STSB	2.2	960	960	960	960	960	960	960
WQRES636STSB	2.4	1008	1008	1008	1008	1008	1008	1008
WQRES639STSB	2.6	1057	1057	1057	1057	1057	1057	1057
WQRES642STSB	2.7	1105	1105	1105	1105	1105	1105	1105
WQRES645STSB	3.0	1153	1153	1153	1153	1153	1153	1153
WQRES648STSB	3.2	1202	1202	1202	1202	1202	1202	1202

- 30", 33", and 36" high have four fixed shelves including top/bottom.
- 39", 42", 45", and 48" high have five fixed shelves including top/bottom.
- 3/4" thick back and side.
- Solid-wood construction.
- All shelves are square.

Door & Drawer Options

AF	AOMD	CC	CG	GAMD	HC	IFHG	MC	MD	MFO	PRMD	SHMD	SPLITDR	SPLITDRWS	TCG	TCP
----	------	----	----	------	----	------	----	----	-----	------	------	---------	-----------	-----	-----

End Panel Options

AUTH	CSFPE	EXBK	EXDN	FFD	FL/FR	FPE	INTGE	IPE
------	-------	------	------	-----	-------	-----	-------	-----

Custom Modification Options

ADD_SHLF	ADDTK	ADRW	BVR	CBO	CCO	CFNTO	CFRMO	CLIP	CND	CSDGBK	EX	EX_OL	FALL	FBFL	FLUT	FTK	ID	IH ¹
----------	-------	------	-----	-----	-----	-------	-------	------	-----	--------	----	-------	------	------	------	-----	----	-----------------

INVERM	IW	LIGHT	MIP	OBRB	PFINBTMB	RD	RECTK	RH ²	ROSLUT	RT	RW	STW	TD	TKP	TVR	WS	WTR
--------	----	-------	-----	------	----------	----	-------	-----------------	--------	----	----	-----	----	-----	-----	----	-----

¹ Not available on 48" high.

² Only available on 30" high.

Wall Quarter Round End Shelves

WALL QUARTER ROUND END SHELF, 12" RADIUS, CLIPPED SHELVES, 30", 33", 36", 39", 42", 45", or 48" HIGH

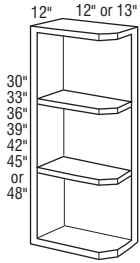

	Cubic Feet	1	2	3	4	5	6	7
WQRES1230RT	2.0	996	996	996	996	996	996	996
WQRES1233RT	2.2	996	996	996	996	996	996	996
WQRES1236RT	2.4	1094	1094	1094	1094	1094	1094	1094
WQRES1239RT	2.6	1094	1094	1094	1094	1094	1094	1094
WQRES1242RT	2.7	1191	1191	1191	1191	1191	1191	1191
WQRES1245RT	3.0	1239	1239	1239	1239	1239	1239	1239
WQRES1248RT	3.2	1288	1288	1288	1288	1288	1288	1288

- 30", 33", and 36" high have four fixed shelves including top/bottom.
- 39", 42", 45", and 48" high have five fixed shelves including top/bottom.
- 3/4" thick back and side.
- Solid-wood construction.

Door & Drawer Options

AF	AOMD	CC	CG	GAMD	HC	IFHG	MC	MD	MFO	PRMD	SHMD	SPLITDR	SPLITDRWS	TCG	TCP
----	------	----	----	------	----	------	----	----	-----	------	------	---------	-----------	-----	-----

End Panel Options

AUTH	CSFPE	EXBK	EXDN	FFD	FL/FR	FPE	INTGE	IPE
------	-------	------	------	-----	-------	-----	-------	-----

Custom Modification Options

ADD_SHLF	ADDTK	ADRW	BVR	CBO	CCO	CFNTO	CFRMO	CLIP	CND	CSDGBK	EX	EX_OL	F.ALL	FBFL	FLUT	FTK	ID	IH ¹
----------	-------	------	-----	-----	-----	-------	-------	------	-----	--------	----	-------	-------	------	------	-----	----	-----------------

INVFRM	IW	LIGHT	MIP	OBRB	PFINBTMB	RD	RECTK	RH ²	ROSLUT	RT	RW	RTW	TD	TKP	TVR	WS	WTR
--------	----	-------	-----	------	----------	----	-------	-----------------	--------	----	----	-----	----	-----	-----	----	-----

¹ Not available on 48" high.

² Only available on 30" high.

WALL QUARTER ROUND END SHELF, 12" RADIUS, SQUARE TOP and CLIPPED BOTTOM SHELVES, 30", 33", 36", 39", 42", 45", or 48" HIGH

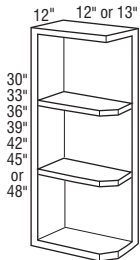

WQRES1230ST L or R	2.0	1042	1042	1042	1042	1042	1042	1042
WQRES1233ST L or R	2.2	1090	1090	1090	1090	1090	1090	1090
WQRES1236ST L or R	2.4	1138	1138	1138	1138	1138	1138	1138
WQRES1239ST L or R	2.6	1187	1187	1187	1187	1187	1187	1187
WQRES1242ST L or R	2.7	1235	1235	1235	1235	1235	1235	1235
WQRES1245ST L or R	3.0	1284	1284	1284	1284	1284	1284	1284
WQRES1248ST L or R	3.2	1334	1334	1334	1334	1334	1334	1334

- L or R denotes square top placement.
- 30", 33", and 36" high have four fixed shelves including top/bottom.
- 39", 42", 45", and 48" high have five fixed shelves including top/bottom.
- 3/4" thick back and side.
- Solid-wood construction.

Door & Drawer Options

AF	AOMD	CC	CG	GAMD	HC	IFHG	MC	MD	MFO	PRMD	SHMD	SPLITDR	SPLITDRWS	TCG	TCP
----	------	----	----	------	----	------	----	----	-----	------	------	---------	-----------	-----	-----

End Panel Options

AUTH	CSFPE	EXBK	EXDN	FFD	FL/FR	FPE	INTGE	IPE
------	-------	------	------	-----	-------	-----	-------	-----

Custom Modification Options

ADD_SHLF	ADDTK	ADRW	BVR	CBO	CCO	CFNTO	CFRMO	CLIP	CND	CSDGBK	EX	EX_OL	F.ALL	FBFL	FLUT	FTK	ID	IH ¹
----------	-------	------	-----	-----	-----	-------	-------	------	-----	--------	----	-------	-------	------	------	-----	----	-----------------

INVFRM	IW	LIGHT	MIP	OBRB	PFINBTMB	RD	RECTK	RH ²	ROSLUT	RT	RW	STW	TD	TKP	TVR	WS	WTR
--------	----	-------	-----	------	----------	----	-------	-----------------	--------	----	----	-----	----	-----	-----	----	-----

¹ Not available on 48" high.

² Only available on 30" high.

IH/RH availability charts starting on page G•40.
IW/RW availability charts starting on page G•46.

Wall Quarter Round End Shelves & Wall Spice Pull-out Cabinets

WALL QUARTER ROUND END SHELF, 12", SQUARE SHELVES, 30", 33", 36", 39", 42", 45", or 48" HIGH

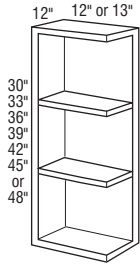

	Cubic Feet	1	2	3	4	5	6	7
WQRES1230STSB	2.0	1042	1042	1042	1042	1042	1042	1042
WQRES1233STSB	2.2	1090	1090	1090	1090	1090	1090	1090
WQRES1236STSB	2.4	1138	1138	1138	1138	1138	1138	1138
WQRES1239STSB	2.6	1187	1187	1187	1187	1187	1187	1187
WQRES1242STSB	2.7	1235	1235	1235	1235	1235	1235	1235
WQRES1245STSB	3.0	1284	1284	1284	1284	1284	1284	1284
WQRES1248STSB	3.2	1334	1334	1334	1334	1334	1334	1334

- 30", 33", and 36" high have four fixed shelves including top/bottom.
- 39", 42", 45", and 48" high have five fixed shelves including top/bottom.
- 3/4" thick back and side.
- Solid-wood construction.

Door & Drawer Options

AF	AOMD	CC	CG	GAMD	HC	IFHG	MC	MD	MFO	PRMD	SHMD	SPLITDR	SPLITDRWS	TCG	TCP
----	------	----	----	------	----	------	----	----	-----	------	------	---------	-----------	-----	-----

End Panel Options

AUTH	CSFPE	EXBK	EXDN	FFD	FL/FR	FPE	INTGE	IPE
------	-------	------	------	-----	-------	-----	-------	-----

Custom Modification Options

ADD_SHLF	ADDTK	ADRW	BVR	CBO	CCO	CFNT0	CFRMO	CLIP	CND	CSDGBK	EX	EX_OL	FALL	FBFL	FLUT	FTK	ID	IH ¹
----------	-------	------	-----	-----	-----	-------	-------	------	-----	--------	----	-------	------	------	------	-----	----	-----------------

INVFRM	IW	LIGHT	MIP	OBRB	PFINBTMB	RD	RECTK	RH ²	ROSLUT	RT	RW	RTW	TD	TKP	TVR	WS	WTR
--------	----	-------	-----	------	----------	----	-------	-----------------	--------	----	----	-----	----	-----	-----	----	-----

¹ Not available on 48" high.

² Only available on 30" high.

WALL SPICE PULL-OUT CABINET, 30", 33", 36", 39", or 42" HIGH

L O G I X

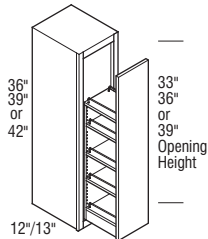
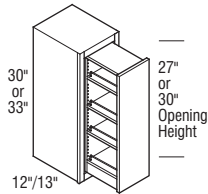

WSP930	2.8	1401	1469	1520	1605	1700	1855	2010
WSP1230	3.6	1485	1556	1610	1700	1801	1963	2125
WSP933	3.0	1598	1674	1733	1826	1935	2116	2297
WSP1233	3.9	1726	1810	1875	1977	2094	2283	2472

WSP936	3.3	1687	1771	1832	1930	2047	2236	2425
WSP1236	4.2	1810	1896	1963	2070	2192	2396	2600
WSP939	3.6	1806	1892	1958	2064	2187	2388	2589
WSP1239	4.6	1914	2005	2075	2187	2319	2530	2741
WSP942	3.8	1920	2013	2081	2195	2327	2542	2757
WSP1242	4.9	2043	2138	2216	2334	2473	2703	2933

Notes below apply to all products in section above:

- Includes adjustable shelves.
- Pull-out features Smart Stop.

Door & Drawer Options

AF	AOMD	CC	CG	GAMD	HC	IFHG	MC	MD	MFO	PRMD	SHMD	SPLITDR	SPLITDRWS	TCG	TCP
----	------	----	----	------	----	------	----	----	-----	------	------	---------	-----------	-----	-----

End Panel Options

AUTH	CSFPE	EXBK	EXDN	FFD	FL/FR	FPE	INTGE	IPE
------	-------	------	------	-----	-------	-----	-------	-----

Custom Modification Options

ADD_SHLF	ADDTK	ADRW	BVR	CBO ¹	CCO ²	CFNT0	CFRMO	CLIP	CND	CSDGBK	EX	EX_OL	FALL	FBFL	FLUT ³	FTK ⁴	ID	IH
----------	-------	------	-----	------------------	------------------	-------	-------	------	-----	--------	----	-------	------	------	-------------------	------------------	----	----

INVFRM	IW	LIGHT	MIP	OBRB	PFINBTMB	RD	RECTK	RH	ROSLUT ⁵	RT	RW	STW	TD	TKP	TVR	WS	WTR
--------	----	-------	-----	------	----------	----	-------	----	---------------------	----	----	-----	----	-----	-----	----	-----

¹ Not available on 33" or 39" high.

² Not available on 30", 36" or 42" high.

³ Not available on 30", 36" or 42" high and not available with fluting both or 6" fluting.

⁴ Not available on FTKAV and style B-L.

⁵ Not available on 30", 36" or 42" high and not available with fluting both.

Wall Spice Rack Cabinets

WALL SPICE RACK CABINET, 30", 33", 36", 39", or 42" HIGH

L O G I X

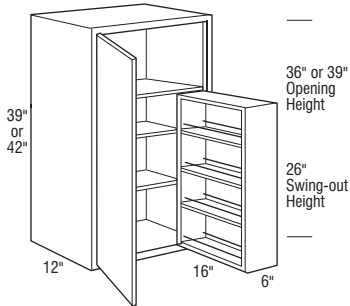
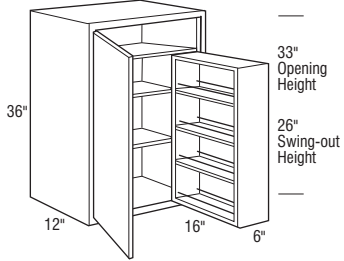
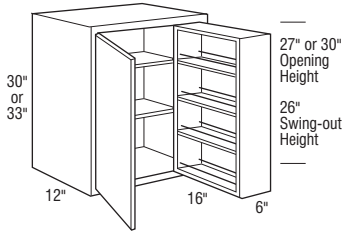

	Cubic Feet	1	2	3	4	5	6	7
WSRC2130 L or R	5.9	1853	1944	2011	2121	2245	2453	2661
WSRC2133 L or R	6.5	1915	2009	2078	2188	2320	2532	2744
WSRC2136 L or R	7.1	1976	2070	2142	2261	2394	2614	2834
WSRC2139 L or R	7.6	2043	2138	2216	2334	2475	2703	2931
WSRC2142 L or R	8.2	2107	2209	2283	2411	2554	2790	3026

• Two 4 1/4" deep shelves are included behind swing-out spice rack.

• Two 4 1/4" deep shelves are included behind swing-out spice rack; one fixed shelf above swing-out.

Notes below apply to all products in section above:

- Hinged opposite cabinet door.
- Two 4 1/4" deep shelves are included behind swing-out spice rack; one fixed shelf above swing-out.
- Increased Depths available in 1/4" increments from 12 1/4" to 30".
- Not available on Inset and Beaded Inset styles.

Door & Drawer Options

AF	AOMD	CC	CG	GAMD	HC	IFHG	MC	MD	MFO	PRMD	SHMD	SPLITDR	SPLITDRWS	TCG ¹	TCP ¹
			✓	✓	✓	✓	✓	✓	✓	✓				✓	✓

End Panel Options

AUTH	CSFPE	EXBK	EXDN	FFD	FL/FR	FPE	INTGE	IPE
✓	✓	✓	✓	✓	✓	✓	✓	✓

Custom Modification Options

ADD	SHLF	ADTK	ADRW	BVR	CBO	CCO	CFNTO	CFRMO	CLIP	CND ²	CSDGBK	EX	EX_OL	FALL	FBFL	FLUT ³	FTK	ID	IH
✓				✓	✓	✓	✓			✓	✓	✓	✓			✓	✓	✓	✓

INVERM	IW	LIGHT	MIP	OBRB	PFINBTMB	RD ⁴	RECTK	RH	ROSFLUT ⁵	RT	RW	STW	TD	TKP	TVR	WS	WTR
	✓		✓	✓	✓	✓	✓		✓							✓	✓

¹ Not available on 30" or 33" high.

² Not available on 36" or 42" high.

³ Not available with fluting both or 6" fluting.

⁴ Not available on 33" or 39" high.

⁵ Not available with fluting both.

IH/RH availability charts starting on page G•40.
IW/RW availability charts starting on page G•46.

WALL BOX COLUMN PULL-OUT, PLAIN, 30", 33", 36", 39", or 42" HIGH, 12" DEEP

L G I X

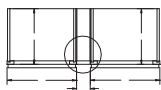
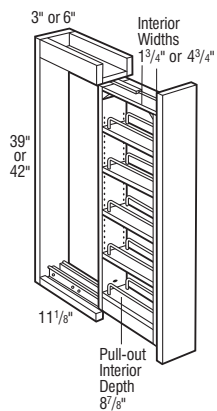
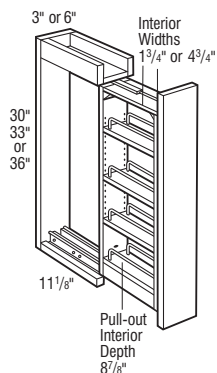

Top View Installation



Top View

	Cubic Feet	1	2	3	4	5	6	7
WBCPO330	1.2	994	994	994	994	994	994	994
WBCPO630	2.0	1297	1297	1297	1297	1297	1297	1297
WBCPO333	1.4	1358	1412	1451	1518	1580	1699	1818
WBCPO633	2.2	1371	1426	1466	1533	1597	1717	1837
WBCPO336	1.5	1378	1433	1474	1541	1605	1726	1847
WBCPO636	2.4	1450	1508	1551	1623	1691	1821	1951

WBCPO339	1.6	1572	1636	1684	1763	1838	1981	2124
WBCPO639	2.6	1606	1672	1721	1803	1880	2026	2172
WBCPO342	1.7	1634	1701	1751	1835	1913	2063	2213
WBCPO642	2.8	1662	1731	1782	1867	1947	2100	2253

- Includes adjustable shelves.
- Standard face application includes filler with overlay.
- Finger pull routed on bottom edge of wall unit. Hardware optional.
- Bottom of unit is always Natural Maple.
- Pull-out features Smart Stop.
- Not available on Inset and Beaded Inset styles.

Door & Drawer Options

AF	AOMD	CC	CG	GAMD	HC	IFHG	MC	MD	MFO	PRMD	SHMD	SPLITDR	SPLITDRWS	TCG	TCP
									✓						

End Panel Options

AUTH	CSFPE	EXBK	EXDN	FFD	FL/FR	FPE	INTGE	IPE

Custom Modification Options

ADD_SHLF	ADDTK	ADRW	BVR	CBO	CCO	CFNTO	CFRMO	CLIP	CND	CSDGBK	EX	EX_OL	FALL	FBFL	FLUT	FTK	ID	IH
																✓		

INVERM	IW	LIGHT	MIP	OBRB	PFINBTMB	RD	RECTK	RH	ROSELUT	RT	RW	RTW	TD	TKP	TVR	WS	WTR
			✓						✓								

Wall Box Column Pull-outs

WALL BOX COLUMN PULL-OUT, OVERLAY, 30", 33", 36", 39", or 42" HIGH, 12" DEEP

L G I X

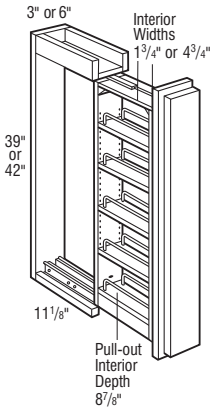
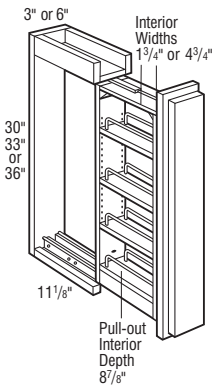

	Cubic Feet	1	2	3	4	5	6	7
WBCPO3300L	1.2	994	994	994	994	994	994	994
WBCPO6300L	2.0	1297	1297	1297	1297	1297	1297	1297
WBCPO3330L	1.4	1083	1137	1176	1243	1305	1424	1543
WBCPO6330L	2.2	1096	1151	1191	1258	1322	1442	1562
WBCPO3360L	1.5	1103	1158	1199	1266	1330	1451	1572
WBCPO6360L	2.4	1175	1233	1276	1348	1416	1546	1676

WBCPO3390L	1.6	1297	1361	1409	1488	1563	1706	1849
WBCPO6390L	2.6	1331	1397	1446	1528	1605	1751	1897
WBCPO3420L	1.7	1359	1426	1476	1560	1638	1788	1938
WBCPO6420L	2.8	1387	1456	1507	1592	1672	1825	1978

- Overlay standard.
- Edge profile will match door profile selected (#10, #12, #14, #17, #27).
- Finger pull routed on bottom edge of wall unit. Hardware optional.
- Pull-out features Smart Stop.
- Available on end of run.
- Three adjustable shelves.
- Fluting modification available when the No Overlay modification is selected.
- Bottom of unit is always Natural Maple.
- Not available on Inset and Beaded Inset styles.

Door & Drawer Options

AF	AOMD	CC	CG	GAMD	HC	IFHG	MC	MD	MFO	PRMD	SHMD	SPLITDR	SPLITDRWS	TCG	TCP
															✓

End Panel Options

AUTH	CSFPE	EXBK ¹	EXDN	FFD	FL/FR	FPE	INTGE	IPE
		✓						

Custom Modification Options

ADD_SHLF	ADDTK	ADRW	BVR	CBO	CCO	CFNTO	CFRMO	CLIP	CND	CSDGBK	EX	EX_OL	F.ALL	FBFL	FLUT	FTK	ID	IH	
																			✓

INVERM	IW	LIGHT	MIP	OBRB	PFINBTMB	RD	RECTK	RH	ROSLUT	RT	RW	STW	TD	TKP	TVR	WS	WTR	
										✓								✓

¹ Not available with end extended back left.

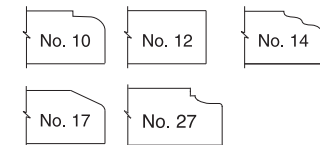
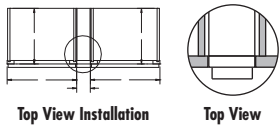

IH/RH availability charts starting on page G-40.
IW/RW availability charts starting on page G-46.

WALL BOX COLUMN PULL-OUT with K-CUP*, 30" HIGH, 12" DEEP

L O G I X

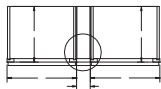
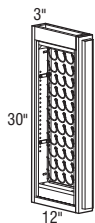

Top View Installation



Top View



No. 10



No. 12



No. 14



No. 17

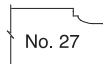

No. 27

WBPCOKCUP330

Cubic Feet	1	2	3	4	5	6	7
1.2	1085	1085	1085	1085	1085	1085	1085

- Holds 44 K-Cups.
- The K-Cup pull-out is compatible with K-Cup pods only.
- Overlay standard.
- Edge profile will match door profile selected (#10, #12, #14, #17, #27).
- Finger pull routed on bottom edge of wall unit. Hardware optional.
- Wire rack comes factory installed on the left side and can be reversed in the field.
- Smart Stop feature not available on pull-out.
- Available on end of run.
- Fluting modification available when the No Overlay modification is selected.
- Bottom of unit is always Natural Maple.
- Not available on Inset and Beaded Inset styles.

*K-Cup is a registered trademark of Keurig Green Mountain, Inc.

Door & Drawer Options

AF	AOMD	CC	CG	GAMD	HC	IFHG	MC	MD	MFO	PRMD	SHMD	SPLITDR	SPLITDRWS	TCG	TCP
----	------	----	----	------	----	------	----	----	-----	------	------	---------	-----------	-----	-----

End Panel Options

AUTH	CSFPE	EXBK	EXDN	FFD	FL/FR	FPE	INTGE	IPE
------	-------	------	------	-----	-------	-----	-------	-----

Custom Modification Options

ADD_SHLF	ADDTK	ADRW	BVR	CBO	CCO	CFNTO	CFRMO	CLIP	CND	CSDGBK	EX	EX_OL	FALL	FBFL	FLUT	FTK	ID	IH
----------	-------	------	-----	-----	-----	-------	-------	------	-----	--------	----	-------	------	------	------	-----	----	----

INVFRM	IW	LIGHT	MIP	OBRB	PFINBTMB	RD	RECTK	RH	ROSLUT	RT	RW	STW	TD	TKP	TVR	WS	WTR
--------	----	-------	-----	------	----------	----	-------	----	--------	----	----	-----	----	-----	-----	----	-----

Notes









How to Use Your Diamond Edge Price List

Your Diamond Edge price guide contains charts with prices for each cabinetry product, arranged according to an alphabetical code. Use the chart below to determine the price code for your preferred cabinetry style.

Then refer to the various sections of this binder to find the types and sizes of cabinets required. Read across each chart to the column that corresponds to your style's price code to determine the price for each unit.

For example, if you want a range hood in the Karis Cherry style, you would

- Find the price code for Karis Cherry ("3" in the chart below)
- Refer to the "Wood Hoods and Hearths" section of this binder
- Locate product code WHA36 (WHA=Wall Hood Arched, 36=width in inches)
- Read across the chart in the same row to column 3 to find the price for this model in Karis Cherry

Door Styles	Alder	Cherry	Maple	MDF	Quartersawn Oak	Rustic Alder	Walnut
Brooks	3	5	3		5	3	6
Brooks Beaded Inset	3+15%	5+15%	3+15%		5+15%	3+15%	6+15%
Brooks Inset	3+15%	5+15%	3+15%		5+15%	3+15%	6+15%
Caldera 	3	5	3		5	3	6
Daxton	2	4	2		4	2	6
Daxton Beaded Inset	2+15%	4+15%	2+15%		4+15%	2+15%	6+15%
Daxton Inset	2+15%	4+15%	2+15%		4+15%	2+15%	6+15%
Gunther	1	3	1		3	1	5
Gunther Beaded Inset	1+15%	3+15%	1+15%		3+15%	1+15%	5+15%
Gunther Inset	1+15%	3+15%	1+15%		3+15%	1+15%	5+15%
Karis	1	3	1		3	1	5
Karis Beaded Inset	1+15%	3+15%	1+15%		3+15%	1+15%	5+15%
Karis Inset	1+15%	3+15%	1+15%		3+15%	1+15%	5+15%
Langley	5	6	5		6	5	7
Langley Beaded Inset	5+15%	6+15%	5+15%		6+15%	5+15%	7+15%
Langley Inset	5+15%	6+15%	5+15%		6+15%	5+15%	7+15%
Montgomery 	1	3	1		3	1	5
Montgomery Beaded Inset 	1+15%	3+15%	1+15%		3+15%	1+15%	5+15%
Montgomery Inset 	1+15%	3+15%	1+15%		3+15%	1+15%	5+15%
Shona	1	3	1		3	1	5
Shona Beaded Inset	1+15%	3+15%	1+15%		3+15%	1+15%	5+15%
Shona Inset	1+15%	3+15%	1+15%		3+15%	1+15%	5+15%
Sumner 	3	5	3		5	3	6
Tackett	2	4	2		4	2	6
Tackett Beaded Inset	2+15%	4+15%	2+15%		4+15%	2+15%	6+15%
Tackett Inset	2+15%	4+15%	2+15%		4+15%	2+15%	6+15%
Trystan 	4	6	4	1	6		7
Trystan Beaded Inset 				1+15%			
Trystan Inset 				1+15%			
Vesta	2	4	2		4	2	6
Vesta Beaded Inset	2+15%	4+15%	2+15%		4+15%	2+15%	6+15%
Vesta Inset	2+15%	4+15%	2+15%		4+15%	2+15%	6+15%
Wells 	4	6	4		6	4	7

Diamond Edge Modification Option Descriptions

Your Diamond Edge price guide contains charts with modification option codes for each applicable cabinetry product. Reference the listing below to identify the modification description.

Door & Drawer Options

Option	Description
AF	Aluminum Door
CC	Craftsman Door
CG	Cut-for-glass
GAMD	Gallery Mullion Door
IFHG	Inset Finial Hinges
MD	Mullion Door
MFO	Modified Full Overlay
PRMD	Prairie Mullion Door
SHMD	Shaker Mullion Door

End Panel Options

Option	Description
AUTH	Authentic Flush End
CSFPE	Car Siding Flush Panel End
EXBK	End Extended Back
EXDN	Wall End and Back Extended Down
FPE	Flush Panel End
INTGE	Integral End
IPE	Inset Panel Ends

Custom Modification Options

Option	Description
ADD_SHLF	Add Shelf
ADDTK	Add Toekick
ADRW	Add Drawer Below Wall Unit
BVR	Bottom Valance Rail
CBO	Cabinet Box Only
CCO	Cabinet Case Only
CFNTO	Cabinet Front Only
CFRMO	Cabinet Frame Only
CND	Cabinet No Door
CSDGBK	Car Siding Back
EX	Extended Stile
EX_OL	Extended Stile with Overlay
FLUT	Fluting
FTK	Flush Toekick
ID	Increased Depth
IW	Increased Width
MIP	Matching Interior
OBRB	Open Bottom Rail Base
PFINBTMB	Finished Bottom
RD	Reduced Depth
RECTK	Recessed Toekick
ROSLUT	Rose Fluting
RW	Reduced Width
TKP	Toekick Pedestal
WS	Wide Stiles
WTR	Wide Top Rail

CLASSIC WOOD HOOD ARCH, 36", 42", or 48" WIDE, 24 7/8" HIGH

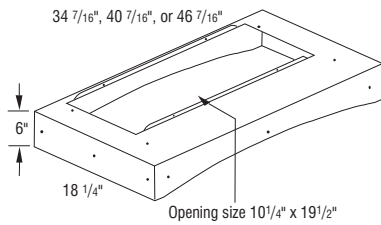
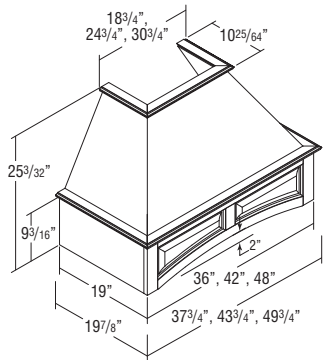

Cubic Feet	1	2	3	4	5	6	7
WHA36	14.0	2590	2590	2590	2590	2590	2590
WHA42	16.0	2936	2936	2936	2936	2936	2936
WHA48	18.0	3182	3182	3182	3182	3182	3182

- Freestanding unit. (Must be properly secured to wall and cannot be attached to adjacent cabinets.)
- Silver Metallic liner included. Assembly required.
- Arched raised panel valance front.
- Exhaust system not included.
- Installation instructions and hardware included.
- Alder substituted for Rustic Alder.
- Compatible with all blowers offered by Diamond Edge.
- Chimney available (WHC).
- Check your local building code for installation heights above the range.
- Range hoods are ordered on an "as required" basis. No changes or cancellations will be accepted after 24 hours from acknowledgment of order.

Modifications
Are Not
Available

NEW WOOD HOOD ARCH FLAT PANEL, 30", 36", 42", or 48" WIDE

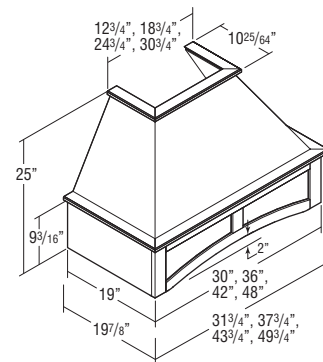

WHAFP30	23.3	4063	4063	4063	4063	4063	4063
WHAFP36	30.6	4198	4198	4198	4198	4198	4198
WHAFP42	30.6	4333	4333	4333	4333	4333	4333
WHAFP48	35.0	4469	4469	4469	4469	4469	4469

- Freestanding unit. (Must be properly secured to wall and cannot be attached to adjacent cabinets.)
- Silver Metallic liner included. Assembly required.
- Arched flat panel valance front.
- Exhaust system not included.
- Installation instructions and hardware included.
- Alder substituted for Rustic Alder.
- Compatible with all blowers offered by Diamond Edge.
- Chimney available (WHC).
- Check your local building code for installation heights above the range.
- Liner opening size: 10 1/4" deep x 19 1/2" wide.
- Range hoods are ordered on an "as required" basis. No changes or cancellations will be accepted after 24 hours from acknowledgment of order.

Modifications
Are Not
Available

Wood Hoods

CLASSIC WOOD HOOD SQUARE, 30", 36", 42", or 48" WIDE, 22 7/8" HIGH

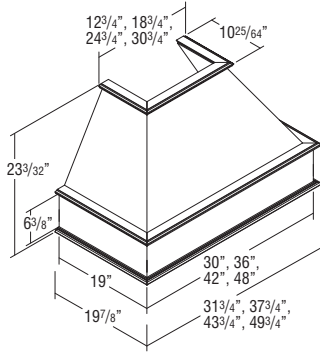

	Cubic Feet	1	2	3	4	5	6	7
WHS30	23.3	1990	1990	1990	1990	1990	1990	1990
WHS36	30.6	1990	1990	1990	1990	1990	1990	1990
WHS42	30.6	2339	2339	2339	2339	2339	2339	2339
WHS48	35.0	2642	2642	2642	2642	2642	2642	2642

- Freestanding unit. (Must be properly secured to wall and cannot be attached to adjacent cabinets.)
- Silver Metallic liner included. Assembly required.
- Exhaust system not included.
- Installation instructions and hardware included.
- Alder substituted for Rustic Alder.
- Compatible with all blowers offered by Diamond Edge.
- Chimney available (WHC).
- Check your local building code for installation heights above the range.
- Range hoods are ordered on an "as required" basis. No changes or cancellations will be accepted after 24 hours from acknowledgment of order.

Modifications
Are Not
Available

28 7/16", 34 7/16", 40 7/16", or 46 7/16"

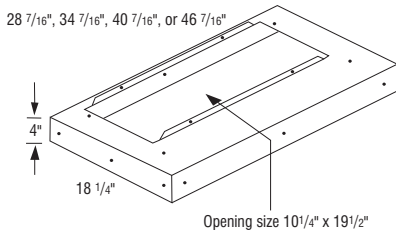

WOOD HOOD SQUARE FLAT PANEL, 30", 36", 42", or 48" WIDE

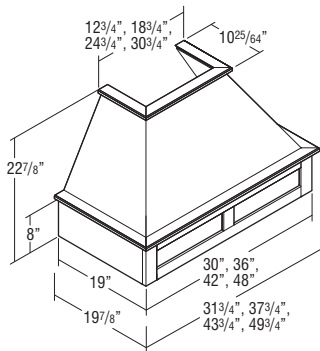

WHSFP30	23.3	4063	4063	4063	4063	4063	4063	4063
WHSFP36	30.6	4198	4198	4198	4198	4198	4198	4198
WHSFP42	30.6	4333	4333	4333	4333	4333	4333	4333
WHSFP48	35.0	4469	4469	4469	4469	4469	4469	4469

- Freestanding unit. (Must be properly secured to wall and cannot be attached to adjacent cabinets.)
- Silver Metallic liner included. Assembly required.
- Square flat panel valance front.
- Exhaust system not included.
- Installation instructions and hardware included.
- Alder substituted for Rustic Alder.
- Compatible with all blowers offered by Diamond Edge.
- Chimney available (WHC).
- Check your local building code for installation heights above the range.
- Liner opening size: 10 1/4" deep x 19 1/2" wide.
- Range hoods are ordered on an "as required" basis. No changes or cancellations will be accepted after 24 hours from acknowledgment of order.

Modifications
Are Not
Available

CLASSIC WOOD HOOD CHIMNEY, 23 1/2" HIGH

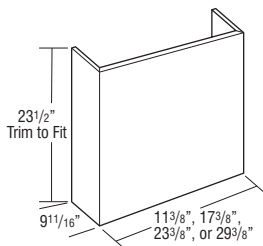

WHC30	1.5	499	499	499	499	499	499	499
WHC36	3.0	499	499	499	499	499	499	499
WHC42	4.0	599	599	599	599	599	599	599
WHC48	5.0	698	698	698	698	698	698	698

- Height trimmable up to 23".
- If trimmed, moulding is recommended to conceal any cut marks.
- Optional accessory for WHA*, WHAFP*, WHS*, and WHSFP* wood hoods.
- 3/4" plywood.
- Alder substituted for Rustic Alder.
- Chimneys are ordered on an "as required" basis. No changes or cancellations will be accepted after 24 hours from acknowledgment of order.

Modifications
Are Not
Available

IH/RH availability charts starting on page G-40.
IW/RW availability charts starting on page G-46.

WOOD HOOD CANOPY ARCHED, 30", 36", WHCA30 or 42" WIDE, 24", 30", or 36" HIGH

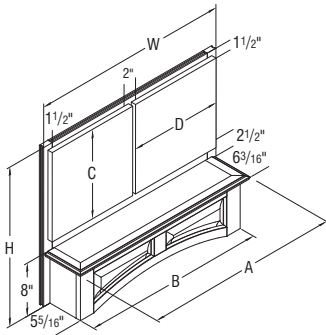

	Cubic Feet	1	2	3	4	5	6	7
WHCA30	4.0	3248	3248	3248	3248	3248	3248	3248
WHCA36	4.8	3543	3543	3543	3543	3543	3543	3543
WHCA42	5.6	3873	3873	3873	3873	3873	3873	3873
JWHCA3030	5.0	3414	3414	3414	3414	3414	3414	3414
JWHCA3630	5.9	3875	3875	3875	3875	3875	3875	3875
JWHCA4230	6.9	4140	4140	4140	4140	4140	4140	4140
WHCA3036	5.9	3390	3390	3390	3390	3390	3390	3390
WHCA3636	7.1	3663	3663	3663	3663	3663	3663	3663
WHCA4236	8.2	4432	4432	4432	4432	4432	4432	4432

- Area above mantel will match selected door style.
- Range hoods are ordered on an "as required" basis. No changes or cancellations will be accepted after 24 hours from acknowledgment of order.
- Install wood hood between 2 adjacent cabinets.
- Exhaust system not included.
- Compatible with all blowers offered by Diamond Edge.
- Installation instructions and hardware included.
- Liner opening size: 10 1/4" deep x 19 1/2" wide.
- Alder substituted for Rustic Alder.
- Square silver metallic liner included. Assembly required.
- Beaded Inset is not available.
- Modifications available on applied doors only, including: Non Beaded Inset, Inset Finial Hinges, Modified Full Overlay, Mullion Doors, and Prairie Mullion Doors.

	Width (W)	Height (H)	Max. Width (A)	Min. Width (B)	Opening Height (C)	Opening Width (D)
WHCA30	30"	24"	29 9/16"	27 13/16"	12"	12 1/2"
WHCA36	36"	24"	35 9/16"	33 13/16"	12"	15 1/2"
WHCA42	42"	24"	41 9/16"	39 13/16"	12"	18 1/2"
JWHCA3030	30"	30"	29 9/16"	27 13/16"	18"	12 1/2"
JWHCA3630	36"	30"	35 9/16"	33 13/16"	18"	15 1/2"
JWHCA4230	42"	30"	41 9/16"	39 13/16"	18"	18 1/2"
WHCA3036	30"	36"	29 9/16"	27 13/16"	24"	12 1/2"
WHCA3636	36"	36"	35 9/16"	33 13/16"	24"	15 1/2"
WHCA4236	42"	36"	41 9/16"	39 13/16"	24"	18 1/2"

Door & Drawer Options

AF	CC	CG	GAMD	IFHG	MD	MFO	PRMD	SHMD
<input checked="" type="checkbox"/>	<input checked="" type="checkbox"/>	<input checked="" type="checkbox"/>	<input checked="" type="checkbox"/>	<input checked="" type="checkbox"/>	<input checked="" type="checkbox"/>	<input checked="" type="checkbox"/>	<input checked="" type="checkbox"/>	<input checked="" type="checkbox"/>

End Panel Options

AUTH	CSFPE	EXBK	EXDN	FPE	INTGE	IPE
<input type="checkbox"/>	<input type="checkbox"/>	<input type="checkbox"/>	<input type="checkbox"/>	<input type="checkbox"/>	<input type="checkbox"/>	<input type="checkbox"/>

Custom Modification Options

ADD_SHLF	ADDTK	ADRW	BVR	CBO	CCO	CFNTO	CFRMO	CND	CSDGBK	EX	EX_OL	FLUT	FTK	ID	IW	MIP	OBRB	PFINBTMB
<input type="checkbox"/>	<input type="checkbox"/>	<input type="checkbox"/>	<input type="checkbox"/>	<input type="checkbox"/>	<input type="checkbox"/>	<input type="checkbox"/>	<input type="checkbox"/>	<input checked="" type="checkbox"/>	<input type="checkbox"/>	<input type="checkbox"/>	<input type="checkbox"/>	<input type="checkbox"/>	<input type="checkbox"/>	<input type="checkbox"/>	<input type="checkbox"/>	<input type="checkbox"/>	<input type="checkbox"/>	<input type="checkbox"/>

RD	RECTK	ROSLUT	RW	TKP	WS	WTR
<input type="checkbox"/>	<input type="checkbox"/>	<input type="checkbox"/>	<input type="checkbox"/>	<input type="checkbox"/>	<input type="checkbox"/>	<input type="checkbox"/>

Wood Hoods

WOOD HOOD CANOPY SQUARE, 30", 36", or 42" WIDE, 24", 30", or 36" HIGH

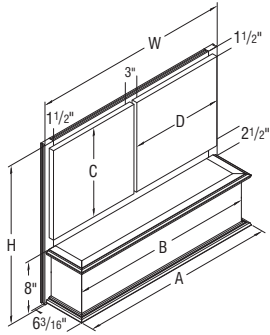

	Cubic Feet	1	2	3	4	5	6	7
WHCS30	4.0	2839	2839	2839	2839	2839	2839	2839
WHCS36	4.8	3134	3134	3134	3134	3134	3134	3134
WHCS42	5.6	3444	3444	3444	3444	3444	3444	3444
JWHCS3030	5.0	2890	2890	2890	2890	2890	2890	2890
JWHCS3630	5.9	3281	3281	3281	3281	3281	3281	3281
JWHCS4230	6.9	3603	3603	3603	3603	3603	3603	3603
WHCS3036	5.9	3181	3181	3181	3181	3181	3181	3181
WHCS3636	7.1	3350	3350	3350	3350	3350	3350	3350
WHCS4236	8.2	3748	3748	3748	3748	3748	3748	3748

- Area above mantel will match selected door style.
- Range hoods are ordered on an "as required" basis. No changes or cancellations will be accepted after 24 hours from acknowledgment of order.
- Install wood hood between 2 adjacent cabinets.
- Exhaust system not included.
- Compatible with all blowers offered by Diamond Edge.
- Installation instructions and hardware included.
- Liner opening size: 10 1/4" deep x 19 1/2" wide.
- Alder substituted for Rustic Alder.
- Square silver metallic liner included. Assembly required.
- Beaded Inset is not available.
- Modifications available on applied doors only, including: Inset Finial Hinges, Modified Full Overlay, Mullion Doors, and Prairie Mullion Doors.

	Width (W)	Height (H)	Max. Width (A)	Min. Width (B)	Opening Height (C)	Opening Width (D)
WHCS30	30"	24"	29 9/16"	27 13/16"	12"	12 1/2"
WHCS36	36"	24"	35 9/16"	33 13/16"	12"	15 1/2"
WHCS42	42"	24"	41 9/16"	39 13/16"	12"	18 1/2"
JWHCS3030	30"	30"	29 9/16"	27 13/16"	18"	12 1/2"
JWHCS3630	36"	30"	35 9/16"	33 13/16"	18"	15 1/2"
JWHCS4230	42"	30"	41 9/16"	39 13/16"	18"	18 1/2"
WHCS3036	30"	36"	29 9/16"	27 13/16"	24"	12 1/2"
WHCS3636	36"	36"	35 9/16"	33 13/16"	24"	15 1/2"
WHCS4236	42"	36"	41 9/16"	39 13/16"	24"	18 1/2"

Door & Drawer Options

AF	CC	CG	GAMD	IFHG	MD	MFO	PRMD	SHMD
	✓	✓	✓	✓	✓	✓	✓	✓

End Panel Options

AUTH	CSFPE	EXBK	EXDN	FPE	INTGE	IPE

Custom Modification Options

ADD	SHLF	ADDTK	ADRW	BVR	CBO	CCO	CFNTD	CFRMO	CND	CSDGBK	EX	EX_OL	FLUT	FTK	ID	IW	MIP	OBRB	PFINBTMB
									✓										

RD	RECTK	ROSLUT	RW	TKP	WS	WTR

IH/RH availability charts starting on page G•40.
IW/RW availability charts starting on page G•46.



WOOD HOOD STRAIGHT BATTEN - PROFILED, 30" or 36" WIDE, 24" HIGH

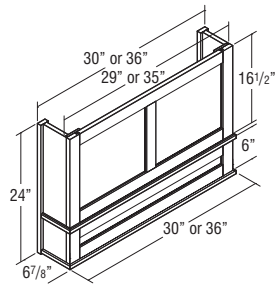

WHSBATTEN3024

Cubic Feet	1	2	3	4	5	6	7
8.6	2885	2885	2885	2885	2885	2885	2885
10.2	3250	3250	3250	3250	3250	3250	3250

WHSBATTEN3624

- Install wood hood between 2 adjacent cabinets.
- Exhaust system not included.
- Compatible with all blowers offered by Diamond Edge.
- Check your local building code for installation heights above the range.
- Square silver metallic liner included. Assembly required.
- Installation instructions and hardware included.
- Liner opening size: 10 1/4" deep x 19 1/2" wide.
- Fronts will match the door style profile selected. Image shown with shaker profile.
- Grain runs vertical on center panels in upper section and horizontal on center panel in lower section.
- Alder substituted for Rustic Alder.
- Range hoods are ordered on an "as required" basis. No changes or cancellations will be accepted after 24 hours from acknowledgment of order.
- Not available with Slab door styles.
- Inset and Beaded Inset is not available.
- All doors are square.

Modifications
Are Not
Available



WOOD HOOD STRAIGHT BATTEN - PROFILED, 30", 36", or 42" WIDE, 36" HIGH

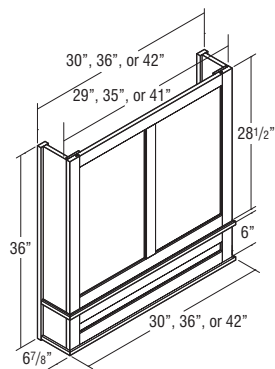

WHSBATTEN3036

Cubic Feet	1	2	3	4	5	6	7
8.6	3550	3550	3550	3550	3550	3550	3550
10.2	3976	3976	3976	3976	3976	3976	3976
11.8	4374	4374	4374	4374	4374	4374	4374

WHSBATTEN3636

WHSBATTEN4236

- Install wood hood between 2 adjacent cabinets.
- Exhaust system not included.
- Compatible with all blowers offered by Diamond Edge.
- Check your local building code for installation heights above the range.
- Square silver metallic liner included. Assembly required.
- Installation instructions and hardware included.
- Liner opening size: 10 1/4" deep x 19 1/2" wide.
- Fronts will match the door style profile selected. Image shown with shaker profile.
- Grain runs vertical on center panels in upper section and horizontal on center panel in lower section.
- Alder substituted for Rustic Alder.
- Range hoods are ordered on an "as required" basis. No changes or cancellations will be accepted after 24 hours from acknowledgment of order.
- Not available with Slab door styles.
- Inset and Beaded Inset is not available.
- All doors are square.

Modifications
Are Not
Available

Wood Hoods

WOOD HOOD NANTUCKET ARCH, 36", 42", or 48" WIDE, 24 7/8" HIGH

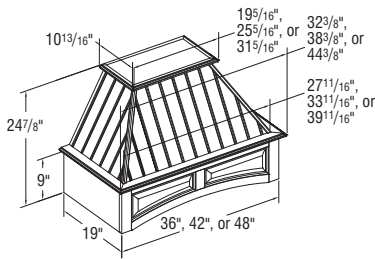

	Cubic Feet	1	2	3	4	5	6	7
WHNA36	12.3	5799	5799	5799	5799	5799	5799	5799
WHNA42	14.3	6162	6162	6162	6162	6162	6162	6162
WHNA48	16.2	6415	6415	6415	6415	6415	6415	6415

- Range hoods are ordered on an "as required" basis. No changes or cancellations will be accepted after 24 hours from acknowledgment of order.
- Exhaust system not included.
- Compatible with all blowers offered by Diamond Edge .
- Chimney available (WHNC).
- Beading spacing 3" on center.
- Arched raised panel valance front.
- Installation instructions and hardware included.
- Silver metallic liner included. Assembly required.
- Liner opening size: 10 1/4" deep x 19 1/2" wide.
- Alder substituted for Rustic Alder.
- Check your local building code for installation heights above the range.

Modifications
Are Not
Available

WOOD HOOD NANTUCKET STRAIGHT, 36", 42", or 48" WIDE, 22 7/8" HIGH

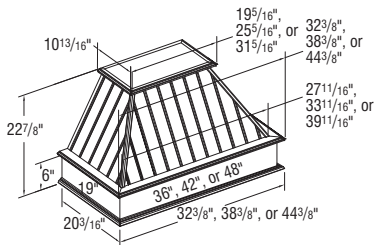

	Cubic Feet	1	2	3	4	5	6	7
WHNS36	12.3	5319	5319	5319	5319	5319	5319	5319
WHNS42	14.3	5485	5485	5485	5485	5485	5485	5485
WHNS48	16.2	5650	5650	5650	5650	5650	5650	5650

- Range hoods are ordered on an "as required" basis. No changes or cancellations will be accepted after 24 hours from acknowledgment of order.
- Exhaust system not included.
- Compatible with all blowers offered by Diamond Edge .
- Chimney available (WHNC).
- Beading spacing 3" on center.
- Installation instructions and hardware included.
- Silver metallic liner included. Assembly required.
- Liner opening size: 10 1/4" deep x 19 1/2" wide.
- Alder substituted for Rustic Alder.
- Check your local building code for installation heights above the range.

Modifications
Are Not
Available

WOOD HOOD NANTUCKET CHIMNEY, 31" HIGH

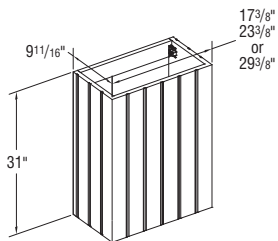

	Cubic Feet	1	2	3	4	5	6	7
WHNC36	4.3	1630	1630	1630	1630	1630	1630	1630
WHNC42	5.7	1781	1781	1781	1781	1781	1781	1781
WHNC48	7.1	1866	1866	1866	1866	1866	1866	1866

- Chimneys are ordered on an "as required" basis. No changes or cancellations will be accepted after 24 hours from acknowledgment of order.
- Optional accessory for Wood Hood Nantucket (WHNA & WHNS).
- Alder substituted for Rustic Alder.
- Height trimmable up to 23 1/2".
- 3/4" plywood.

Modifications
Are Not
Available

IH/RH availability charts starting on page G•40.
IW/RW availability charts starting on page G•46.

WOOD HOOD SHIPLAP STRAIGHT, 36", 42", or 48" WIDE, 42" HIGH

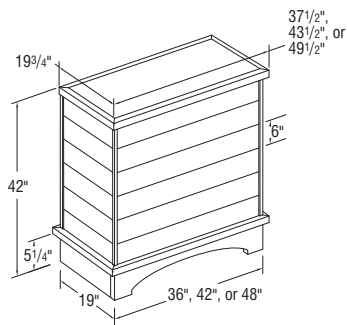

Cubic Feet	1	2	3	4	5	6	7
JWHSHPSTR36	22.0	3885	3885	3885	3885	3885	3885
JWHSHPSTR42	25.2	4112	4112	4112	4112	4112	4112
JWHSHPSTR48	28.4	4456	4456	4456	4456	4456	4456

- Freestanding unit. (Must be properly secured to wall and cannot be attached to adjacent cabinets).
- Range hoods are ordered on an "as required" basis. No changes or cancellations will be accepted after 24 hours from acknowledgment of order.
- Exhaust system not included.
- Square silver metallic liner included. Assembly required.
- Compatible with all blowers offered by Diamond Edge.
- Liner opening size: 10 1/4" deep x 19 1/2" wide.
- Alder substituted for Rustic Alder.
- Wood hood corner moulding shipped unattached.
- Constructed of 3/4" thick grooved plywood creating a shiplap appearance.
- Trimmable. If trimmed, moulding is recommended to conceal any cut marks.
- Installation instructions and hardware included.
- Check local building code and appliance installation specifications for clearance requirements and installation heights above the range.

Modifications
Are Not
Available

WOOD HOOD SHIPLAP STRAIGHT with CORBELS, 36", 42", or 48" WIDE, 42" HIGH

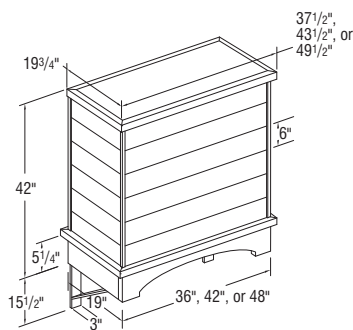

JWHSHPSTRCB36	22.0	4767	4767	4767	4767	4767	4767
JWHSHPSTRCB42	25.2	4993	4993	4993	4993	4993	4993
JWHSHPSTRCB48	28.4	5338	5338	5338	5338	5338	5338

- Freestanding unit. (Must be properly secured to wall and cannot be attached to adjacent cabinets).
- Includes a pair of decorative corbels.
- Range hoods are ordered on an "as required" basis. No changes or cancellations will be accepted after 24 hours from acknowledgment of order.
- Exhaust system not included.
- Square silver metallic liner included. Assembly required.
- Compatible with all blowers offered by Diamond Edge.
- Liner opening size: 10 1/4" deep x 19 1/2" wide.
- Alder substituted for Rustic Alder.
- Wood hood corner moulding shipped unattached.
- Constructed of 3/4" thick grooved plywood creating a shiplap appearance.
- Trimmable. If trimmed, moulding is recommended to conceal any cut marks.
- Installation instructions and hardware included.
- Check local building code and appliance installation specifications for clearance requirements (including corbels) and installation heights above the range.

Modifications
Are Not
Available

Wood Hoods

WOOD HOOD SHIPLAP TAPERED, 36", 42", or 48" WIDE, 31 1/4" HIGH

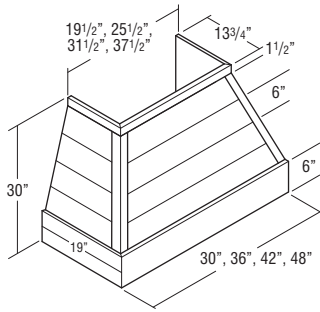

	Cubic Feet	1	2	3	4	5	6	7
JWHSIPT30	22.0	3751	3751	3751	3751	3751	3751	3751
JWHSIPT36	22.0	3885	3885	3885	3885	3885	3885	3885
JWHSIPT42	25.2	4112	4112	4112	4112	4112	4112	4112
JWHSIPT48	28.4	4456	4456	4456	4456	4456	4456	4456

- Freestanding unit. (Must be properly secured to wall and cannot be attached to adjacent cabinets).
- Range hoods are ordered on an "as required" basis. No changes or cancellations will be accepted after 24 hours from acknowledgment of order.
- Exhaust system not included.
- Square silver metallic liner included. Assembly required.
- Compatible with all blowers offered by Diamond Edge.
- Liner opening size: 10 1/4" deep x 19 1/2" wide.
- Alder substituted for Rustic Alder.
- Constructed of 3/4" thick grooved plywood creating a shiplap appearance.
- Installation instructions and hardware included.
- Check local building code and appliance installation specifications for clearance requirements and installation heights above the range.

Modifications
Are Not
Available

WOOD HOOD SHIPLAP TAPERED with CORBELS, 36", 42", or 48" WIDE, 31 1/4" HIGH

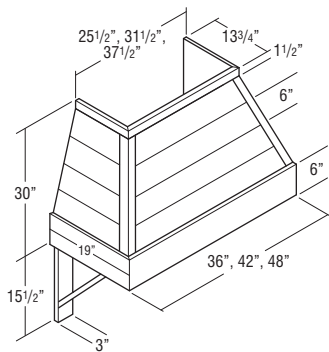

JWHSIPTCB36	22.0	4633	4633	4633	4633	4633	4633	4633
JWHSIPTCB42	25.2	4766	4766	4766	4766	4766	4766	4766
JWHSIPTCB48	28.4	4993	4993	4993	4993	4993	4993	4993

- Freestanding unit. (Must be properly secured to wall and cannot be attached to adjacent cabinets).
- Includes a pair of decorative corbels.
- Range hoods are ordered on an "as required" basis. No changes or cancellations will be accepted after 24 hours from acknowledgment of order.
- Exhaust system not included.
- Square silver metallic liner included. Assembly required.
- Compatible with all blowers offered by Diamond Edge.
- Liner opening size: 10 1/4" deep x 19 1/2" wide.
- Alder substituted for Rustic Alder.
- Constructed of 3/4" thick grooved plywood creating a shiplap appearance.
- Installation instructions and hardware included.
- Check local building code and appliance installation specifications for clearance requirements (including corbels) and installation heights above the range.

Modifications
Are Not
Available

WOOD HOOD SHIPLAP TAPERED CHIMNEY, 30", 36", 42", or 48" WIDE, 23 1/2" HIGH

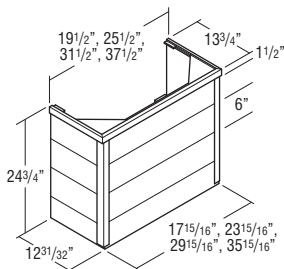

JWHSIPCH30	2.8	1620	1620	1620	1620	1620	1620	1620
JWHSIPCH36	2.8	1683	1683	1683	1683	1683	1683	1683
JWHSIPCH42	3.8	1909	1909	1909	1909	1909	1909	1909
JWHSIPCH48	4.7	2059	2059	2059	2059	2059	2059	2059

- Constructed of 3/4" thick grooved plywood creating a shiplap appearance.
- Trimmable. If trimmed, moulding is recommended to conceal any cut marks.
- Optional accessory for Wood Hood Shiplap Tapered (JWHSIPT and JWHSIPTCB SKUs) for an installed height of 54".
- Alder substituted for Rustic Alder.
- Wood hood corner moulding shipped unattached.
- Constructed of 3/4" thick grooved plywood creating a shiplap appearance.
- Trimmable. If trimmed, moulding is recommended to conceal any cut marks.
- No changes or cancellations will be accepted after 24 hours from acknowledgment of order.

Modifications
Are Not
Available

IH/RH availability charts starting on page G•40.
IW/RW availability charts starting on page G•46.

NEW **WOOD HOOD SIMPLE TAPERED,**
30", 36", 42", or 48" WIDE

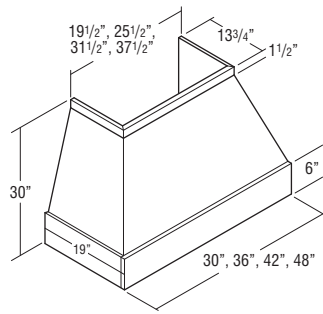

	Cubic Feet	1	2	3	4	5	6	7
WHSMT30	27.7	4333	4333	4333	4333	4333	4333	4333
WHSMT36	27.7	4731	4731	4731	4731	4731	4731	4731
WHSMT42	31.7	4731	4731	4731	4731	4731	4731	4731
WHSMT48	35.6	5253	5253	5253	5253	5253	5253	5253

- Freestanding unit. (Must be properly secured to wall and cannot be attached to adjacent cabinets.)
- Exhaust system not included.
- Square silver metallic liner included. Assembly required.
- Compatible with all blowers offered by Diamond Edge.
- Compatible with Simple Wood Hood Chimney (WHSMC_), which can be trimmed. See below.
- Installation instructions and hardware included.
- Liner opening size: 10 1/4" deep x 19 1/2" wide.
- Alder substituted for Rustic Alder.
- Check local building code and appliance installation specifications for clearance requirements and installation heights above the range.
- Range hoods are ordered on an "as required" basis. No changes or cancellations will be accepted after 24 hours from acknowledgment of order.

Modifications
Are Not
Available

NEW **WOOD HOOD SIMPLE TAPERED**
with CORBELS, 36", 42", or
48" WIDE

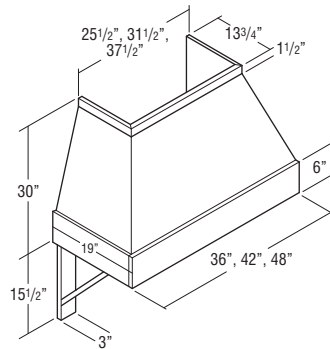

	Cubic Feet	1	2	3	4	5	6	7
WHSMTCB36	27.7	5037	5037	5037	5037	5037	5037	5037
WHSMTCB42	31.7	5334	5334	5334	5334	5334	5334	5334
WHSMTCB48	35.6	5559	5559	5559	5559	5559	5559	5559

- Includes a pair of decorative corbels.
- Freestanding unit. (Must be properly secured to wall and cannot be attached to adjacent cabinets.)
- Exhaust system not included.
- Square silver metallic liner included. Assembly required.
- Compatible with all blowers offered by Diamond Edge.
- Compatible with Simple Wood Hood Chimney (WHSMC_), which can be trimmed. See below.
- Installation instructions and hardware included.
- Liner opening size: 10 1/4" deep x 19 1/2" wide.
- Alder substituted for Rustic Alder.
- Check local building code and appliance installation specifications for clearance requirements and installation heights above the range.
- Range hoods are ordered on an "as required" basis. No changes or cancellations will be accepted after 24 hours from acknowledgment of order.

Modifications
Are Not
Available

NEW **WOOD HOOD SIMPLE CHIMNEY,**
30", 36", 42", or 48" WIDE

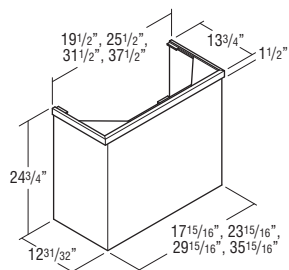

	Cubic Feet	1	2	3	4	5	6	7
WHSMC30	4.3	1625	1625	1625	1625	1625	1625	1625
WHSMC36	5.6	1896	1896	1896	1896	1896	1896	1896
WHSMC42	6.9	2031	2031	2031	2031	2031	2031	2031
WHSMC48	6.9	2167	2167	2167	2167	2167	2167	2167

- Trimmable. If trimmed, moulding is recommended to conceal any cut marks.
- Optional accessory for Simple Tapered Wood Hoods (WHSMT_ and WHSMTCB_) for an installed height of 54".
- Alder substituted for Rustic Alder.
- No changes or cancellations will be accepted after 24 hours from acknowledgment of order.

Modifications
Are Not
Available

Wood Hoods

WOOD HOOD ARTISAN STRAIGHT, 36", 42", or 48" WIDE, 46" HIGH

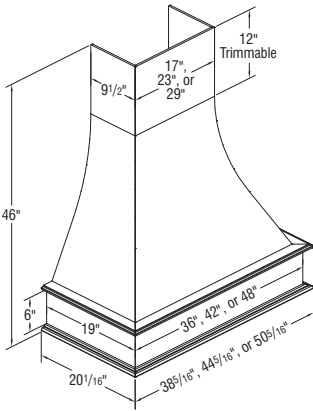

	Cubic Feet	1	2	3	4	5	6	7
WHAS36	23.3	7513	7513	7513	7513	7513	7513	7513
WHAS42	27.0	7944	7944	7944	7944	7944	7944	7944
WHAS48	30.7	8154	8154	8154	8154	8154	8154	8154

- Range hoods are ordered on an "as required" basis. No changes or cancellations will be accepted after 24 hours from acknowledgment of order.
- Exhaust system not included.
- Compatible with all blowers offered by Diamond Edge.
- Installation instructions and hardware included.
- Silver metallic liner included. Assembly required.
- Liner opening size: 10 1/4" deep x 19 1/2" wide.
- Chimney height trimmable up to 34".
- Alder substituted for Rustic Alder.
- Check your local building code for installation heights above the range.

Modifications
Are Not
Available

WOOD HOOD LINEAR, 30", 36", or 42" WIDE, 40 5/16" HIGH

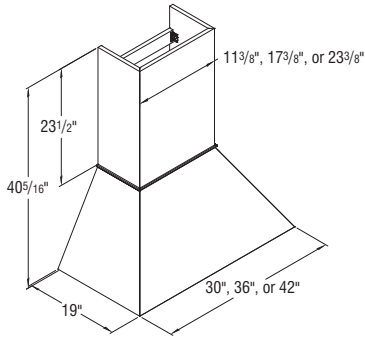

JWHL30	22.0	4238	4238	4238	4238	4238	4238	4238
JWHL36	22.0	4389	4389	4389	4389	4389	4389	4389
JWHL42	25.2	4600	4600	4600	4600	4600	4600	4600

- Range hoods are ordered on an "as required" basis. No changes or cancellations will be accepted after 24 hours from acknowledgment of order.
- Exhaust system not included.
- Compatible with all blowers offered by Diamond Edge.
- Installation instructions and hardware included.
- Silver metallic liner included. Assembly required.
- Liner opening size: 10 1/4" deep x 19 1/2" wide.
- Alder substituted for Rustic Alder.
- Check your local building code for installation heights above the range.

Modifications
Are Not
Available

TAPERED WOOD HOOD, 30" or 36" WIDE, 24" HIGH

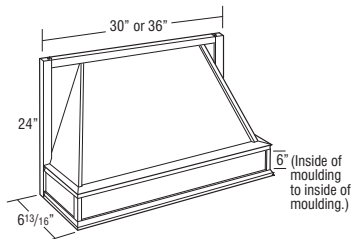

TWH30	4.7	1877	1877	1877	1877	1877	1877	1877
TWH36	5.6	1955	1955	1955	1955	1955	1955	1955

- Install TWH between adjoining cabinets.
- Exhaust system not included.
- Metal liner included.
- Wood hoods are designed for use with decorative overlays.
- Compatible with all blowers offered by Diamond Edge.
- Check your local building code for installation heights above the range.

Modifications
Are Not
Available

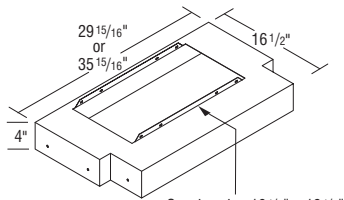

Metal Liner for TWH__ Range Hood

IH/RH availability charts starting on page G•40.
IW/RW availability charts starting on page G•46.

RANGE HOOD STAINLESS STEEL SQUARE, 30" or 36" WIDE

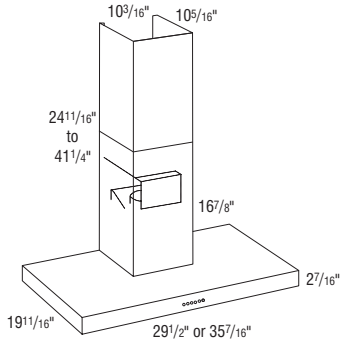

Cubic Feet	1	2	3	4	5	6	7
RHSS30	11.2	5576	5576	5576	5576	5576	5576
RHSS36	13.2	5870	5870	5870	5870	5870	5870

- Range hoods are ordered on an "as required" basis. No changes or cancellations will be accepted after 24 hours from acknowledgment of order.
- Compatible with all blowers offered by Diamond Edge.
- Fan included.
- Installation instructions and hardware included.
- Metal liner not required.
- Includes a 4-speed 600 CFM blower.
- Check your local building codes for installation heights above the range.
- Includes two 20 watt halogen lights.

Modifications
Are Not
Available

RANGE HOOD STAINLESS STEEL TAPERED, 30" or 36" WIDE

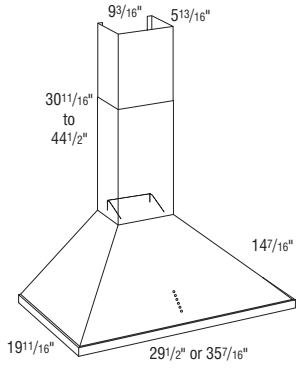

RHST30	11.2	5166	5166	5166	5166	5166	5166
RHST36	13.2	5446	5446	5446	5446	5446	5446

- Range hoods are ordered on an "as required" basis. No changes or cancellations will be accepted after 24 hours from acknowledgment of order.
- Compatible with all blowers offered by Diamond Edge.
- Fan included.
- Installation instructions and hardware included.
- Metal liner not required.
- Includes a 4-speed 600 CFM blower.
- Check your local building codes for installation heights above the range.
- Includes two 20 watt halogen lights.

Modifications
Are Not
Available

STAINLESS HOOD FILTER

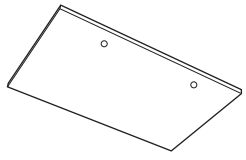

KF2	0.7	380	380	380	380	380	380
------------	-----	-----	-----	-----	-----	-----	-----

- Installation instructions and hardware included.
- For use with RHST and RHSS models.
- Hood Filters are ordered on an "as required" basis. No changes or cancellations will be accepted after 24 hours from acknowledgment of order.

Modifications
Are Not
Available

Range Hoods

	Cubic Feet	1	2	3	4	5	6	7
WOOD HOOD BLOWER, 1100 CFM	BLOWER1100	4.0	9239	9239	9239	9239	9239	9239

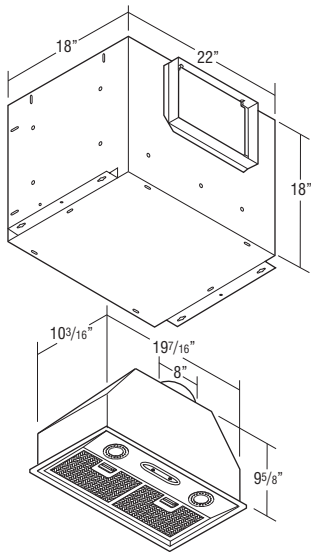

- 1100 CFM.
- Ventilator housing unit features stainless steel finish.
- Two 50 watt (120 volt) halogen lamps included.
- Satellite blower installs remotely in the interior of the home (i.e. unfinished attic area).
- Designed to work independently from internal blowers.
- Installation instructions, warranty, and repair information included.
- External ventilation required.
- Professional installation required.
- Compatible with all Wood Hoods and Hearths.
- Includes 2 inline transition 8"x12" to 10" round.
- Three speed control.
- Includes 2 removable dishwasher safe grease filters.
- Liner sold separately.
- Blowers will be shipped directly to the order destination from the blower manufacturing facility within standard lead times.

Modifications
Are Not
Available

WOOD HOOD BLOWER, 500 CFM

WOOD HOOD BLOWER, 500 CFM	BLOWER500	4.0	3782	3782	3782	3782	3782	3782
----------------------------------	------------------	-----	------	------	------	------	------	------

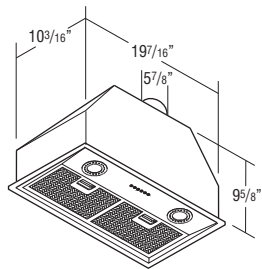

- 500 CFM.
- Two 20 watt (12 volt, G4 base) halogen lamps included.
- Installation instructions, warranty and repair information included.
- Compatible with all Wood Hoods and Hearths.
- Stainless steel finish.
- Three speed push button control.
- Includes two removable dishwasher safe grease filters.
- Liner sold separately.
- Blowers will be shipped directly to the order destination from the blower manufacturing facility within standard lead times.

Modifications
Are Not
Available

WOOD HOOD BLOWER, 390 CFM

WOOD HOOD BLOWER, 390 CFM	TWHBLOWER390	2.0	1687	1687	1687	1687	1687	1687
----------------------------------	---------------------	-----	------	------	------	------	------	------

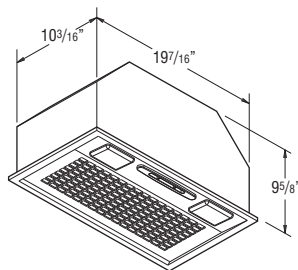

- 390 CFM.
- Range Hood Component Package has 3-speed centrifugal fan and lighted filter control.
- 6" diameter vent.
- 1 year warranty.
- Two 40 watt candelabra lights required, but not included.
- Vented unit. To use as a ventless unit, conversion kit (CONVERSION) must be ordered.
- Installation instructions, warranty and repair info included.
- Compatible with all Wood Hoods and Hearths.
- Sound rating is 6 sones.
- Uses 3.2 amps.
- Metallic gray exterior finish.
- Includes removable dishwasher safe grease filter.
- Liner sold separately.
- Blowers will be shipped directly to the order destination from the blower manufacturing facility within standard lead times.

Modifications
Are Not
Available

IH/RH availability charts starting on page G•40.
IW/RW availability charts starting on page G•46.

DUCTLESS CONVERSION KIT

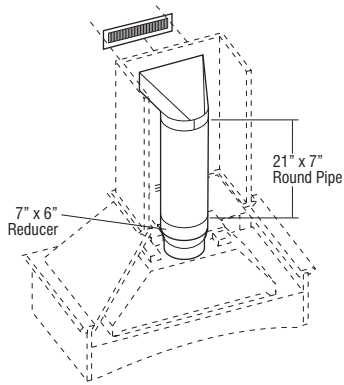

Cubic Feet	1	2	3	4	5	6	7
CONVERSION	2.0	263	263	263	263	263	263
FILTER500	2.8	260	260	260	260	260	260
FILTER250/390	2.8	58	58	58	58	58	58

- Kit includes: 1-21" x 7" round pipe, 1 adjustable collar, 1 White metal soffit grille, 1 adjustable boot, 1-7" x 6" reducer.
- Charcoal filter required (FILTER250/390 or FILTER500).
- Installation instructions included.
- For use with all blowers.

Modifications
Are Not
Available

Hearths

Hearth SKU Collection – 36" High, 21" Deep

Hearth, 66" Wide

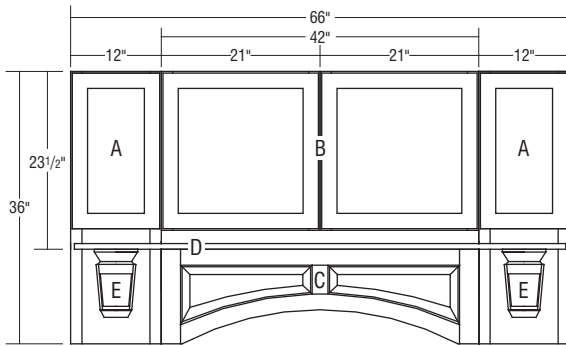

Parts Required	Page Number	Quantity	Size
(A) HP1236 L or R	K•22	2	12 x 36 x 21
(B) H36DF4223.5	K•24	1	42 x 23 1/2 x 1 1/2
(C) JRPV42	R•18	1	3/4 x 12 1/2 x 42
(D) HS66	K•25	1	3/4 x 4 1/2 x 65 1/2
(E) CORBELS	R•28	2	Refer to selection

Hearth, 72" Wide

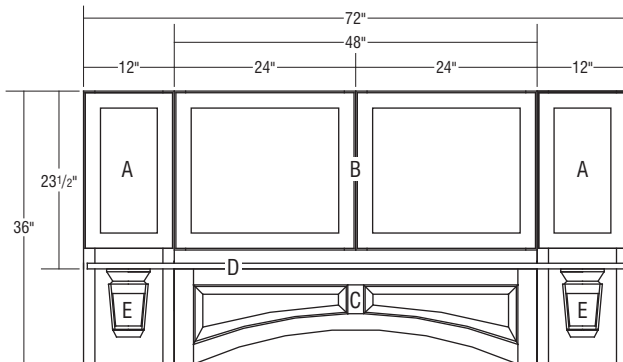

Parts Required	Page Number	Quantity	Size
(A) HP1236 L or R	K•22	2	12 x 36 x 21
(B) H36DF4823.5	K•24	1	48 x 23 1/2 x 1 1/2
(C) RPV48	R•18	1	3/4 x 12 1/2 x 48
(D) HS72	K•25	1	3/4 x 4 1/2 x 71 1/2
(E) CORBELS	R•28	2	Refer to selection

Hearth, 78" Wide

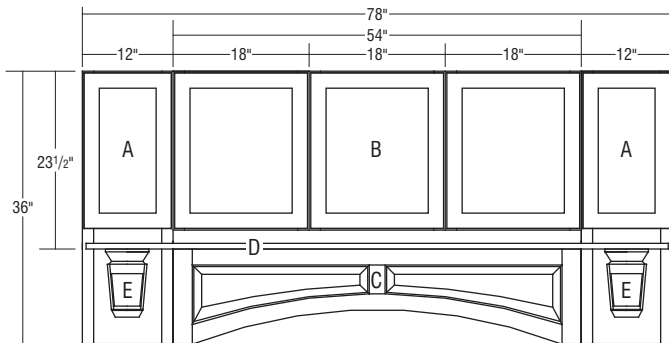

Parts Required	Page Number	Quantity	Size
(A) HP1236 L or R	K•22	2	12 x 36 x 21
(B) H36DF5423.5	K•24	1	54 x 23 1/2 x 1 1/2
(C) RPV54	R•18	1	3/4 x 12 1/2 x 54
(D) HS78	K•25	1	3/4 x 4 1/2 x 77 1/2
(E) CORBELS	R•28	2	Refer to selection

Hearth, 84" Wide

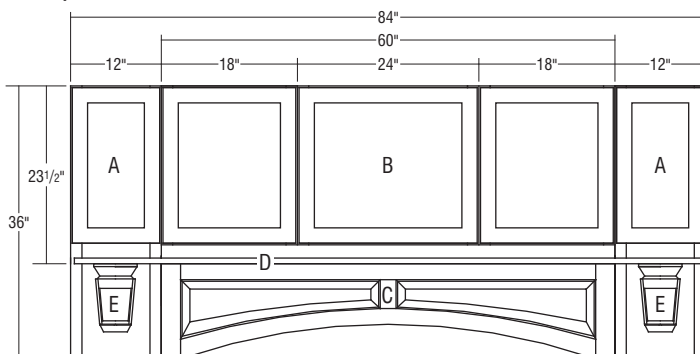

Parts Required	Page Number	Quantity	Size
(A) HP1236 L or R	K•22	2	12 x 36 x 21
(B) H36DF6023.5	K•24	1	60 x 23 1/2 x 1 1/2
(C) RPV60	R•18	1	3/4 x 12 1/2 x 54
(D) HS84	K•25	1	3/4 x 4 1/2 x 83 1/2
(E) CORBELS	R•28	2	Refer to selection

Diamond Edge recommends a clearance of 7" - 12" on each side of a gas burner to a combustible surface, 3" - 6" from non-combustible surfaces including the backsplash surface, and 30" from the vent. Diamond Edge also suggests you reference local codes before installation.

Hearth SKU Collection – 48" High, 21" Deep

Hearth, 66" Wide

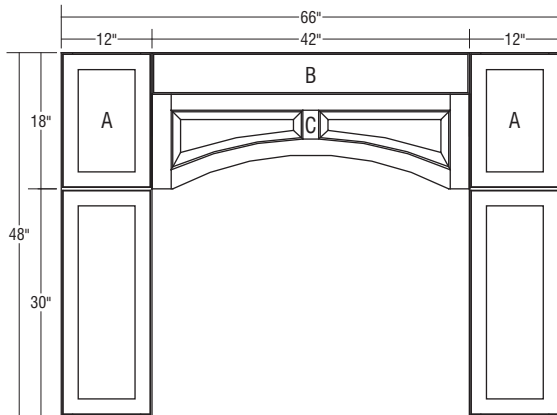

Parts Required	Page Number	Quantity	Size
(A) HP1248 L or R	K•22	2	12 x 48 x 21
(B) HOF42	K•26	1	1 1/2 x 5 1/2 x 42
(C) JRPV42	R•18	1	3/4 x 12 1/2 x 42

Hearth, 72" Wide

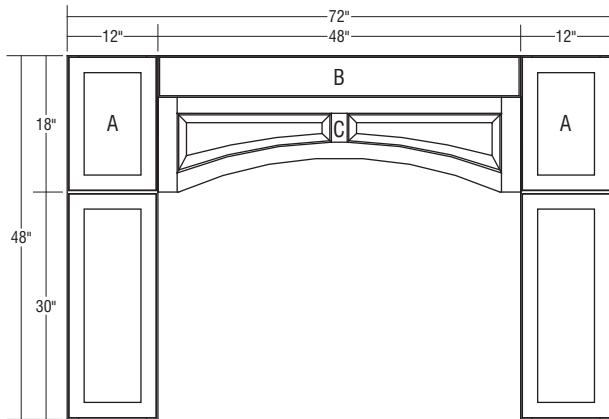

Parts Required	Page Number	Quantity	Size
(A) HP1248 L or R	K•22	2	12 x 48 x 21
(B) HOF48	K•26	1	1 1/2 x 5 1/2 x 48
(C) RPV48	R•18	1	3/4 x 12 1/2 x 48

Hearth, 78" Wide

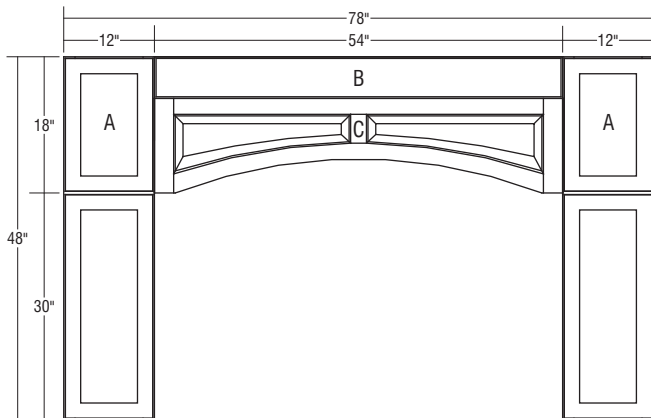

Parts Required	Page Number	Quantity	Size
(A) HP1248 L or R	K•22	2	12 x 48 x 21
(B) HOF54	K•26	1	1 1/2 x 5 1/2 x 54
(C) RPV54	R•18	1	3/4 x 12 1/2 x 54

Diamond Edge recommends a clearance of 7" - 12" on each side of a gas burner to a combustible surface, 3" - 6" from non-combustible surfaces including the backplash surface, and 30" from the vent. Diamond Edge also suggests you reference local codes before installation.

Hearths

Hearth, 84" Wide

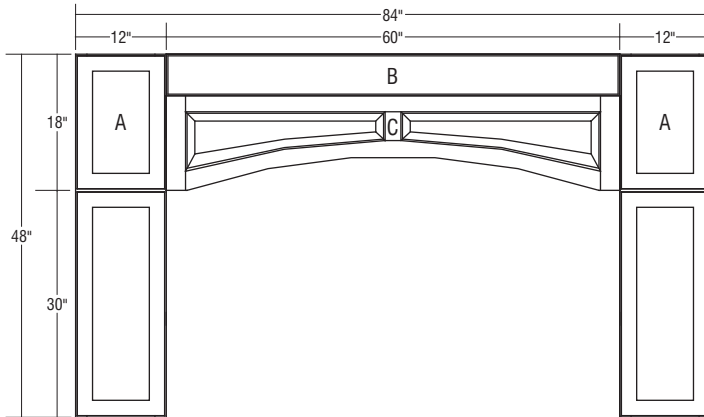

Parts Required	Page Number	Quantity	Size
(A) HP1248 L or R	K•22	2	12 x 48 x 21
(B) HOF60	K•26	1	1 1/2 x 5 1/2 x 60
(C) RPV60	R•18	1	3/4 x 12 1/2 x 60

Hearth SKU Collection – 54" High, 21" Deep

Hearth, 66" Wide

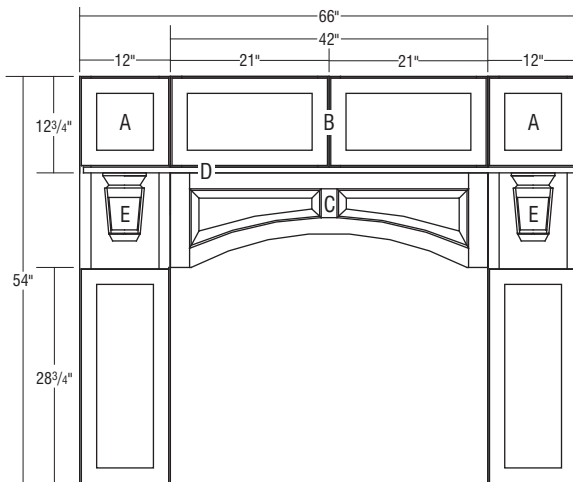

Parts Required	Page Number	Quantity	Size
(A) HP1254 L or R / HPP1254 L or R	K•22	2	12 x 54 x 21
(B) H54DF4212.75	K•24	1	42 x 12 3/4 x 1 1/2
(C) JRPV42	R•18	1	3/4 x 12 1/2 x 42
(D) HS66	K•25	1	3/4 x 4 1/2 x 65 1/2
(E) CORBELS	R•28	2	Refer to selection

Hearth, 72" Wide

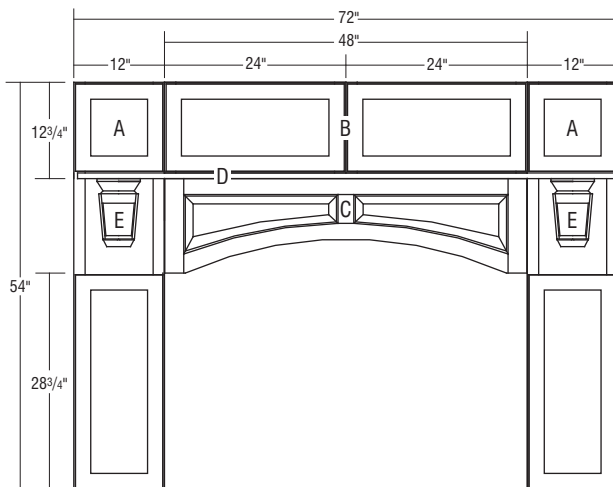

Parts Required	Page Number	Quantity	Size
(A) HP1254 L or R / HPP1254 L or R	K•22	2	12 x 54 x 21
(B) H54DF4812.75	K•24	1	48 x 12 3/4 x 1 1/2
(C) RPV48	R•18	1	3/4 x 12 1/2 x 48
(D) HS72	K•25	1	3/4 x 4 1/2 x 71 1/2
(E) CORBELS	R•28	2	Refer to selection

Diamond Edge recommends a clearance of 7" - 12" on each side of a gas burner to a combustible surface, 3" - 6" from non-combustible surfaces including the backsplash surface, and 30" from the vent. Diamond Edge also suggests you reference local codes before installation.

Hearth, 78" Wide

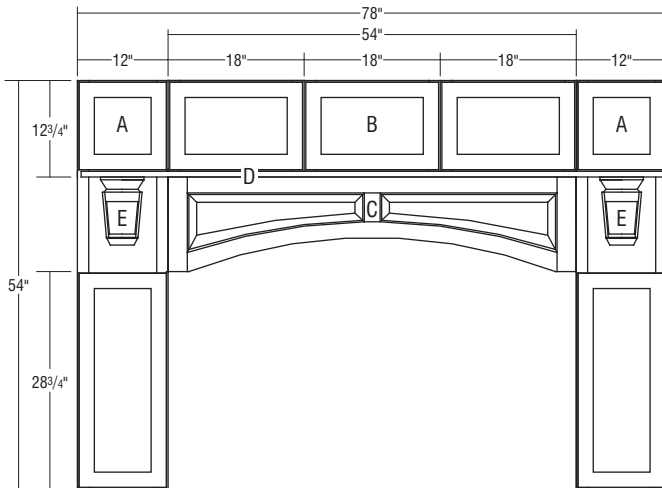

Parts Required	Page Number	Quantity	Size
(A) HP1254 L or R/ HPP1254 L or R	K●22	2	12 x 54 x 21
(B) H54DF5412.75	K●24	1	54 x 12 3/4 x 1 1/2
(C) RPV54	R●18	1	3/4 x 12 1/2 x 54
(D) HS78	K●25	1	3/4 x 4 1/2 x 77 1/2
(E) CORBELS	R●28	2	Refer to selection

Hearth, 84" Wide

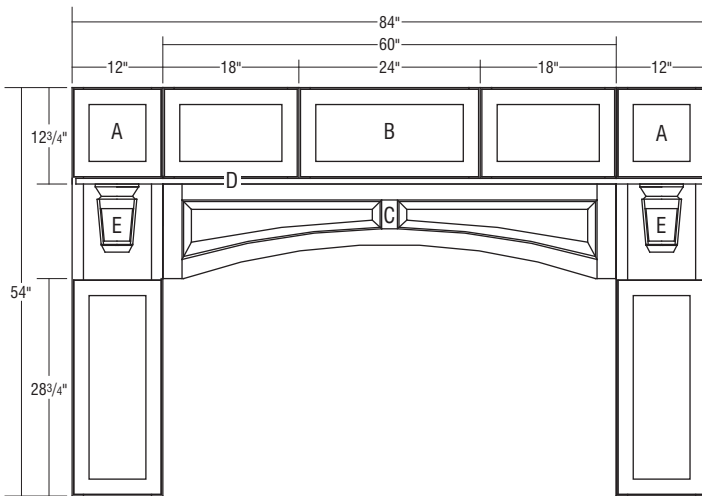

Parts Required	Page Number	Quantity	Size
(A) HP1254 L or R/ HPP1254 L or R	K●22	2	12 x 54 x 21
(B) H54DF6012.75	K●24	1	60 x 12 3/4 x 1 1/2
(C) RPV60	R●18	1	3/4 x 12 1/2 x 60
(D) HS84	K●25	1	3/4 x 4 1/2 x 83 1/2
(E) CORBELS	R●28	2	Refer to selection

Hearth SKU Collection – 60" High, 21" Deep

Hearth, 66" Wide

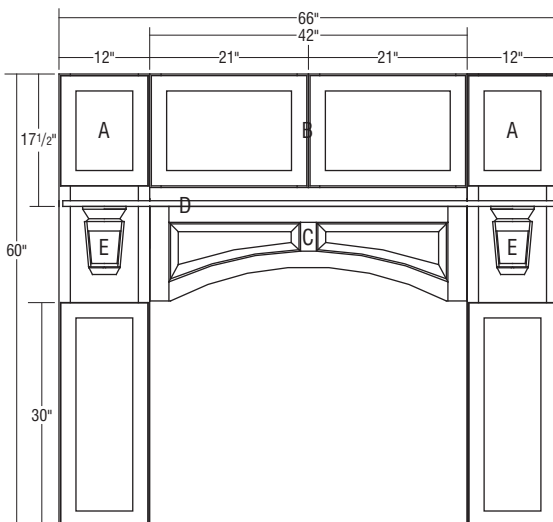

Parts Required	Page Number	Quantity	Size
(A) HP1260 L or R/ HPP1260 L or R	K●22	2	12 x 60 x 21
(B) H60DF4217.5	K●25	1	42 x 17 1/2 x 1 1/2
(C) JRPV42	R●18	1	3/4 x 12 1/2 x 42
(D) HS66	K●25	1	3/4 x 4 1/2 x 65 1/2
(E) CORBELS	R●28	2	Refer to selection

Diamond Edge recommends a clearance of 7" - 12" on each side of a gas burner to a combustible surface, 3" - 6" from non-combustible surfaces including the backsplash surface, and 30" from the vent. Diamond Edge also suggests you reference local codes before installation.

Hearths

Hearth, 72" Wide

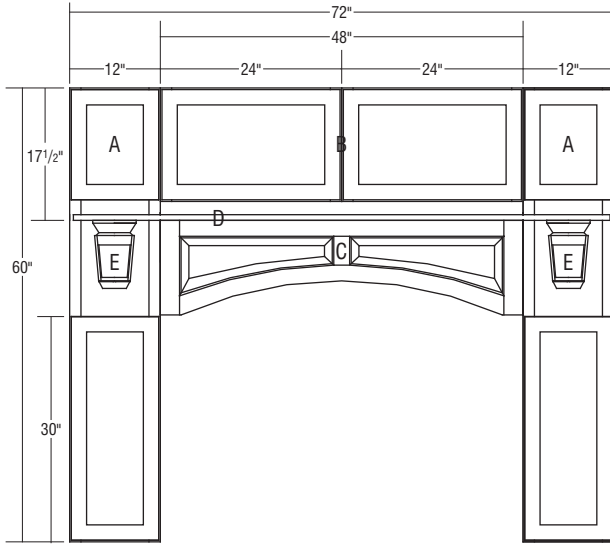

Parts Required	Page Number	Quantity	Size
(A) HP1260 L or R/ HPP1260 L or R	K•22	2	12 x 60 x 21
(B) H60DF4817.5	K•25	1	48 x 17 1/2 x 1 1/2
(C) RPV48	R•18	1	3/4 x 12 1/2 x 48
(D) HS72	K•25	1	3/4 x 4 1/2 x 71 1/2
(E) CORBELS	R•28	2	Refer to selection

Hearth, 78" Wide

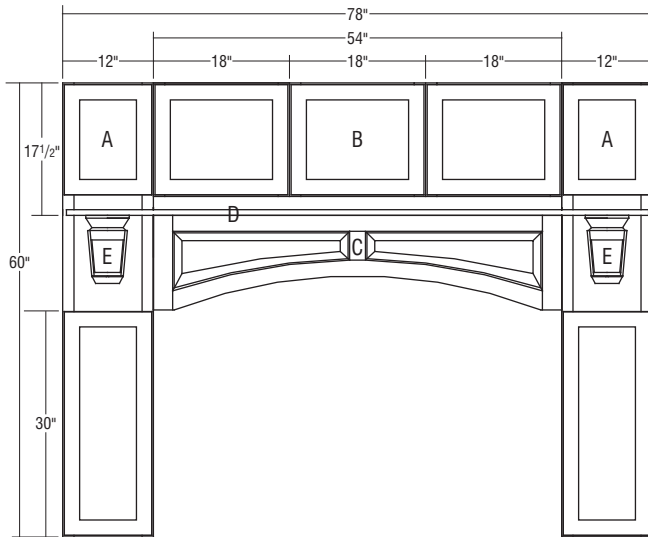

Parts Required	Page Number	Quantity	Size
(A) HP1260 L or R/ HPP1260 L or R	K•22	2	12 x 60 x 21
(B) H60DF5417.5	K•25	1	54 x 17 1/2 x 1 1/2
(C) RPV54	R•18	1	3/4 x 12 1/2 x 54
(D) HS78	K•25	1	3/4 x 4 1/2 x 77 1/2
(E) CORBELS	R•28	2	Refer to selection

Diamond Edge recommends a clearance of 7" - 12" on each side of a gas burner to a combustible surface, 3" - 6" from non-combustible surfaces including the backsplash surface, and 30" from the vent. Diamond Edge also suggests you reference local codes before installation.

Hearth, 84" Wide

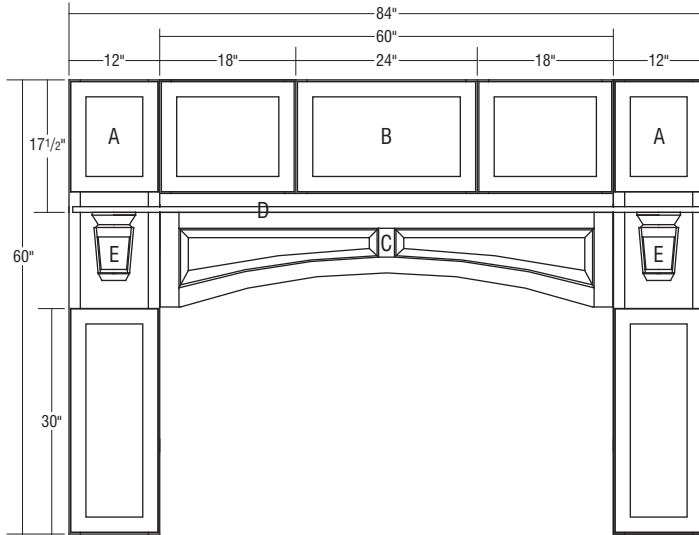

Parts Required	Page Number	Quantity	Size
(A) HP1260 L or R / HPP1260 L or R	K•22	2	12 x 60 x 21
(B) H60DF6017.5	K•25	1	60 x 17 1/2 x 1 1/2
(C) RPV60	R•18	1	3/4 x 12 1/2 x 60
(D) HS84	K•25	1	3/4 x 4 1/2 x 83 1/2
(E) CORBELS	R•28	2	Refer to selection

Diamond Edge recommends a clearance of 7" - 12" on each side of a gas burner to a combustible surface, 3" - 6" from non-combustible surfaces including the backplash surface, and 30" from the vent. Diamond Edge also suggests you reference local codes before installation.

Hearths

HEARTH PIER, 12" WIDE, 36", 48", 54", or 60" HIGH, 21" DEEP

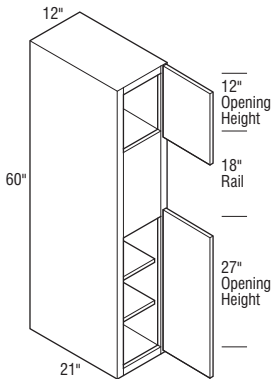
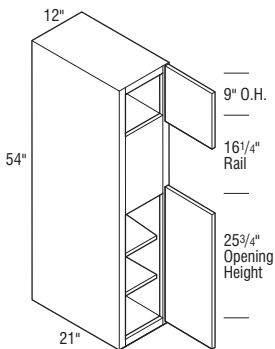
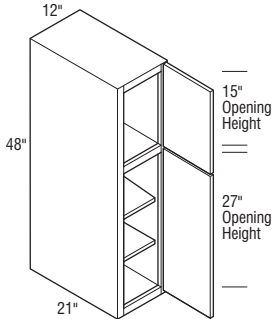
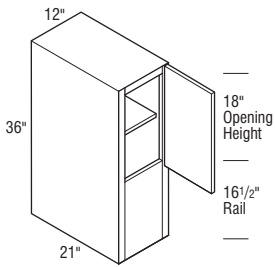

	Cubic Feet	1	2	3	4	5	6	7
HP1236 L or R (12 x 36 x 21)	6.9	1704	1785	1848	1949	2064	2255	2446

- Matching Interior standard.
- Cabinets constructed with:
Top, bottom, one adjustable shelf. No fixed floor under door opening.

HP1248 L or R (12 x 48 x 21)	9.1	1989	2088	2158	2268	2399	2615	2831
-------------------------------------	-----	------	------	------	------	------	------	------

- Cabinets constructed with:
Top, bottom, fixed floor between doors, and two adjustable shelves in bottom opening.

HP1254 L or R (12 x 54 x 21)	10.2	2192	2303	2377	2498	2645	2884	3123
-------------------------------------	------	------	------	------	------	------	------	------

- Cabinets constructed with:
Top, bottom, fixed floor under top door opening, and two adjustable shelves in bottom opening.

HP1260 L or R (12 x 60 x 21)	11.3	2303	2412	2487	2619	2774	3025	3276
-------------------------------------	------	------	------	------	------	------	------	------

- Cabinets constructed with:
Top, bottom, fixed floor under top door opening, and two adjustable shelves in bottom opening.

Notes below apply to all products in section above:

- Finished Ends standard.
- For opening sizes and cabinet dimensions, see page F•11.
- Increased Depths available in 1/4" increments from 21 1/4" to 30".
- Reduced Depths available in 1/4" increments from 6" to 20 3/4".
- Increased or Reduced Widths available in 3" increments. See pages G•48-G•49 for details.
- Not available with Art Glass.

Door & Drawer Options

AF	CC	CG	GAMD	IFHG	MD	MFO	PRMD	SHMD
✓	✓	✓	✓	✓	✓	✓	✓	✓

End Panel Options

AUTH ¹	CSFPE	EXBK	EXDN	FPE	INTGE	IPE
✓	✓	✓	✓	✓	✓	✓

Custom Modification Options

ADD	SHLF ²	ADDTK	ADRW ³	BVR	CBO	CCO	CFNTO	CFRMO	CND	CSDGBK	EX	EX_OL	FLUT ⁴	FTK ⁵	ID	IW	MIP ⁶	OBRB	PFINBTMB
✓	✓	✓	✓	✓	✓	✓	✓	✓	✓	✓	✓	✓	✓	✓	✓	✓	✓	✓	✓

RD	RECTK	ROSLUT	RW	TKP	WS	WTR
✓	✓	✓	✓	✓	✓	✓

- ¹ Not available on authentic flush ends both.
- ² Only available on 36" high.
- ³ Not available on 60" high.
- ⁴ Not available with 6" fluting.
- ⁵ Not available with FTKAV and style B-L.
- ⁶ Not available on 36" high.

IH/RH availability charts starting on page G•40.
IW/RW availability charts starting on page G•46.

HEARTH PIER PULL-OUT, 12" WIDE, 54" or 60" HIGH, 21" DEEP
L G I X

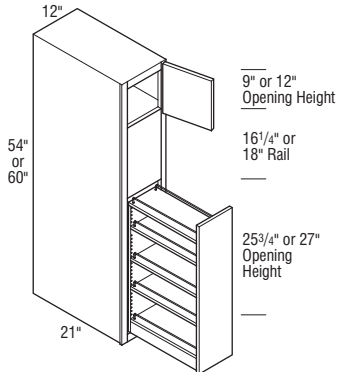

	Cubic Feet	1	2	3	4	5	6	7
HPP1254 L or R	10.2	2861	2970	3046	3166	3315	3552	3789
HPP1260 L or R	11.3	2970	3082	3160	3289	3444	3692	3940

- Finished Ends standard.
- Pull-out features three adjustable shelves with chrome rail sides.
- For opening sizes and cabinet dimensions, see page F●11.
- Not available with Art Glass.

Door & Drawer Options

AF	CC	CG	GAMD ¹	IFHG	MD	MFO	PRMD	SHMD
✓	✓	✓	✓	✓	✓	✓	✓	✓

End Panel Options

AUTH ²	CSFPE	EXBK	EXDN	FPE	INTGE	IPE
✓	✓	✓	✓	✓	✓	✓

Custom Modification Options

ADD_SHLF	ADDTK	ADRW ³	BVR	CBO	CCO	CFNTO	CFRMO	CND	CSDGBK	EX	EX_OL	FLUT ⁴	FTK ⁵	ID	IW	MIP	OBRB	PFINBTMB	
✓	✓	✓	✓	✓	✓	✓	✓	✓	✓	✓	✓	✓	✓	✓	✓	✓	✓	✓	✓

RD	RECTK	ROSLUT	RW	TKP	WS	WTR
✓	✓	✓	✓	✓	✓	✓

¹ Not available on 54" high.
² Not available with authentic flush ends both.
³ Not available on 60" high.
⁴ Not available with 6" fluting.
⁵ Not available with FTKAV and style B-L.

HEARTH MANTEL, 6" or 9" HIGH

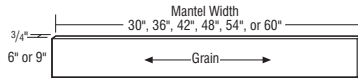

HM306	0.1	124	124	124	124	124	124	124	124
HM366	0.1	156	156	156	156	156	156	156	156
HM426	0.1	183	183	183	183	183	183	183	183
HM486	0.1	210	210	210	210	210	210	210	210
HM546	0.1	239	239	239	239	239	239	239	239
HM606	0.2	265	265	265	265	265	265	265	265
HM309	0.1	186	186	186	186	186	186	186	186
HM369	0.1	233	233	233	233	233	233	233	233
HM429	0.2	275	275	275	275	275	275	275	275
HM489	0.2	316	316	316	316	316	316	316	316
HM549	0.2	363	363	363	363	363	363	363	363
HM609	0.2	407	407	407	407	407	407	407	407

- Recommended for use with 48" high Hearths Piers and same width Arched Valance (see page R●18).

Modifications
Are Not
Available

Hearths

HEARTH DOOR FRONT CONFIGURATIONS, 12 3/4", 23 1/2" HIGH

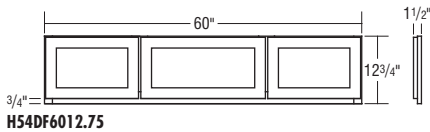
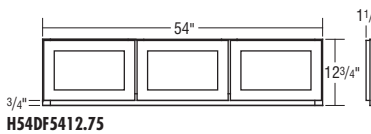
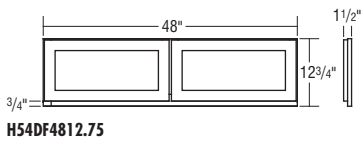
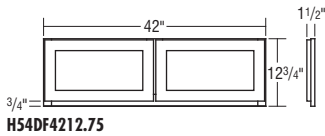
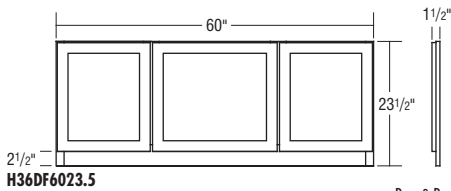
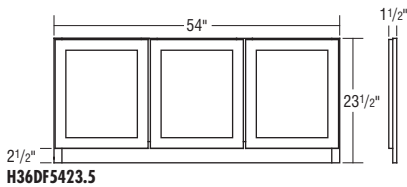
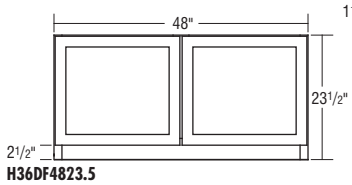
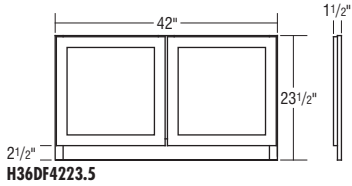

	Cubic Feet	1	2	3	4	5	6	7
H36DF4223.5	2.5	1262	1327	1370	1444	1532	1671	1810
H36DF4823.5	2.9	1397	1465	1517	1598	1690	1849	2008
H36DF5423.5	3.2	1583	1662	1721	1811	1920	2097	2274
H36DF6023.5	3.6	1810	1899	1968	2068	2195	2398	2601
H54DF4212.75	1.4	663	696	718	759	805	875	945
H54DF4812.75	1.6	773	811	840	880	936	1020	1104
H54DF5412.75	1.8	899	939	971	1021	1080	1188	1296
H54DF6012.75	2.0	1028	1079	1118	1177	1249	1363	1477

- Wide Bottom Rail standard.
- Unit is Face Frame and Doors Only. 1 1/2" depth.
- Doors are working doors.
- Three door applications will have middle door hinged left unless otherwise specified.
- Some modifications not available, including Increased or Reduced Depths, Increased or Reduced Heights, Increased or Reduced Widths, Split Doors, Wide Stiles, etc.; for more detail contact customer service.

Door & Drawer Options

AF	CC	CG	GAMD	IFHG	MD	MFO	PRMD ¹	SHMD
<input checked="" type="checkbox"/>	<input checked="" type="checkbox"/>	<input checked="" type="checkbox"/>	<input checked="" type="checkbox"/>	<input checked="" type="checkbox"/>	<input checked="" type="checkbox"/>	<input checked="" type="checkbox"/>	<input checked="" type="checkbox"/>	<input checked="" type="checkbox"/>

End Panel Options

AUTH	CSFPE	EXBK	EXDN	FPE	INTGE	IPE
<input checked="" type="checkbox"/>	<input checked="" type="checkbox"/>	<input checked="" type="checkbox"/>	<input checked="" type="checkbox"/>	<input checked="" type="checkbox"/>	<input checked="" type="checkbox"/>	<input checked="" type="checkbox"/>

Custom Modification Options

ADD_SHLF	ADDTK	ADRW	BVR	CBO	CCO	CFNTO	CFRMO	CND	CSDGBK	EX	EX_OL	FLUT ²	FTK	ID	IW	MIP	OBRB	PFINBTMB
<input checked="" type="checkbox"/>	<input checked="" type="checkbox"/>	<input checked="" type="checkbox"/>	<input checked="" type="checkbox"/>	<input checked="" type="checkbox"/>	<input checked="" type="checkbox"/>	<input checked="" type="checkbox"/>	<input checked="" type="checkbox"/>	<input checked="" type="checkbox"/>	<input checked="" type="checkbox"/>	<input checked="" type="checkbox"/>	<input checked="" type="checkbox"/>	<input checked="" type="checkbox"/>	<input checked="" type="checkbox"/>	<input checked="" type="checkbox"/>	<input checked="" type="checkbox"/>	<input checked="" type="checkbox"/>	<input checked="" type="checkbox"/>	<input checked="" type="checkbox"/>
RD	RECTK	ROSLUT	RW	TKP	WS	WTR												
<input checked="" type="checkbox"/>	<input checked="" type="checkbox"/>	<input checked="" type="checkbox"/>	<input checked="" type="checkbox"/>	<input checked="" type="checkbox"/>	<input checked="" type="checkbox"/>	<input checked="" type="checkbox"/>												

¹ Not available on 12 3/4" high.

² Not available with 6" fluting.

IH/RH availability charts starting on page G•40.
IW/RW availability charts starting on page G•46.

HEARTH DOOR FRONT CONFIGURATIONS, 17 1/2" HIGH

Cubic Feet	1	2	3	4	5	6	7
H60DF4217.5	1.9	939	987	1020	1074	1142	1350
H60DF4817.5	2.2	1062	1115	1153	1215	1288	1522
H60DF5417.5	2.4	1226	1288	1332	1401	1486	1762
H60DF6017.5	2.7	1439	1509	1564	1645	1742	2060

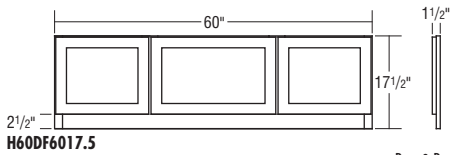
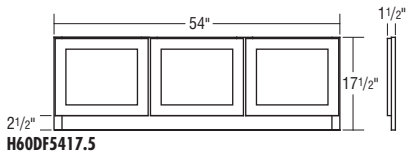
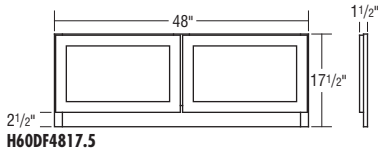
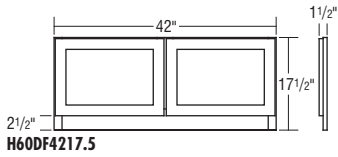

- Wide Bottom Rail standard.
- Unit is Face Frame and Doors Only. 1 1/2" depth.
- Doors are working doors.
- Three door applications will have middle door hinged left unless otherwise specified.
- Some modifications not available, including Increased or Reduced Depths, Increased or Reduced Heights, Increased or Reduced Widths, Split Doors, Wide Stiles, etc.; for more detail contact customer service.

Door & Drawer Options

AF	CC	CG	GAMD	IFHG	MD	MFO	PRMD	SHMD
		✓	✓	✓	✓	✓		✓

End Panel Options

AUTH	CSFPE	EXBK	EXDN	FPE	INTGE	IPE

Custom Modification Options

ADD_SHLF	ADDTK	ADRW	BVR	CBO	CCO	CFNTD	CFRMO	CND	CSDGBK	EX	EX_OL	FLUT ¹	FTK	ID	IW	MIP	OBRB	PFINBTMB
								✓		✓	✓	✓						

RD	RECTK	ROSLUT	RW	TKP	WS	WTR
		✓				✓

¹ Not available with 6" fluting.

HEARTH SHELF, 4 1/2" DEEP

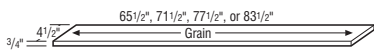

HS66	0.8	176	176	176	176	176	176	176
HS72	0.9	192	192	192	192	192	192	192
HS78	0.9	209	209	209	209	209	209	209
HS84	1.0	228	228	228	228	228	228	228

- Shelf is solid wood finished on both sides, one long edge, and two short edges.
- Available with edge profile. Specify desired profile. No. 12 profile standard. Profiles available: 10, 14, 17, 18, 27. See page D•1 for details.
- Shelves will install on top of corbels (4 1/2" deep) and will slightly overlay the Arched Valance.
- Shelf width should match the overall hearth width (pier width + mantel/valance width).
- Actual shelf width is 1/2" shorter than the dimension in the product code.

Door & Drawer Options

AF	CC	CG	GAMD	IFHG	MD	MFO	PRMD	SHMD
							✓	

End Panel Options

AUTH	CSFPE	EXBK	EXDN	FPE	INTGE	IPE

Custom Modification Options

ADD_SHLF	ADDTK	ADRW	BVR	CBO	CCO	CFNTD	CFRMO	CND	CSDGBK	EX	EX_OL	FLUT	FTK	ID	IW	MIP	OBRB	PFINBTMB

RD	RECTK	ROSLUT	RW	TKP	WS	WTR

Hearths

HEARTH OVERLAY FILLERS, 5 1/2" DEEP

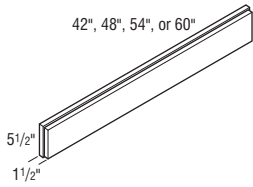

	Cubic Feet	1	2	3	4	5	6	7
HOF42	0.6	412	412	412	412	412	412	412
HOF48	0.7	470	470	470	470	470	470	470
HOF54	0.8	547	547	547	547	547	547	547
HOF60	0.9	615	615	615	615	615	615	615

- Size adjusted to door style overlay.
- Shipped loose.
- Profiled on all 4 sides.

Door & Drawer Options

AF	CC	CG	GAMD	IFHG	MD	MFO	PRMD	SHMD
						✓		

End Panel Options

AUTH	CSFPE	EXBK	EXDN	FPE	INTGE	IPE

Custom Modification Options

ADD_SHLF	ADDTK	ADRW	BVR	CBO	CCO	CFNTD	CFRMO	CND	CSDGBK	EX	EX_OL	FLUT	FTK	ID	IW	MIP	OBRB	PFINBTMB

RD	RECTK	ROSLUT	RW	TKP	WS	WTR

CORBEL SELECTIONS

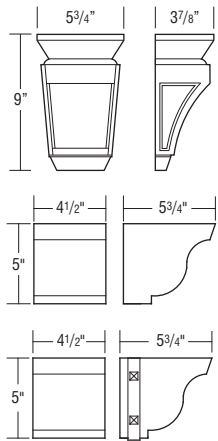

CORBELMIS9	0.3	653	653	653	653	653	653	653
CORBELOWD5	0.2	581	581	581	581	581	581	581
CORBELOWDSTR5	0.2	678	678	678	678	678	678	678

- Oak will be used for Quartersawn Oak on CORBELMIS9.
- Glazes and/or Techniques available: TW, XTW.

Modifications
Are Not
Available

Glazes and Techniques

- F** = Flooded (see page E•4.)
- P** = Penned (see page E•4.)
- TW** = Timeworn (see page E•4.)
- XTW** = Extra Timeworn (see page E•4.)
- HW** = Hewn (see page E•4.)
- XHW** = Extra Hewn (see page E•4.)

HEARTH LINER

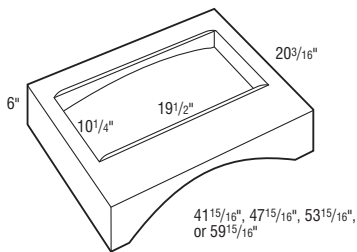

HL42	4.7	1469	1469	1469	1469	1469	1469	1469
HL48	5.4	1490	1490	1490	1490	1490	1490	1490
HL54	6.0	1796	1796	1796	1796	1796	1796	1796
HL60	6.6	1862	1862	1862	1862	1862	1862	1862

- Liner is Metallic Silver.
- Compatible with all blowers offered by Diamond Edge.

Modifications
Are Not
Available

IH/RH availability charts starting on page G•40.
IW/RW availability charts starting on page G•46.

How to Use Your Diamond Edge Price List









Your Diamond Edge price guide contains charts with prices for each cabinetry product, arranged according to an alphabetical code. Use the chart below to determine the price code for your preferred cabinetry style.

Then refer to the various sections of this binder to find the types and sizes of cabinets required. Read across each chart to the column that corresponds to your style's price code to determine the price for each unit.

All Base Cabinets are 34 1/2" High and 24" Deep unless otherwise noted.

For example, if you want a base cabinet that is 12" wide in the Karis Cherry style, you would

- Find the price code for Karis Cherry ("3" in the chart below)
- Refer to the "Base Cabinets" section of this binder
- Locate product code B12 L or R (B = base, 12 = width in inches)
- Read across the chart in the same row to column 3 to find the price for this model in Karis Cherry

Door Styles	Alder	Cherry	Maple	MDF	Quartersawn Oak	Rustic Alder	Walnut
Brooks	3	5	3		5	3	6
Brooks Beaded Inset	3+15%	5+15%	3+15%		5+15%	3+15%	6+15%
Brooks Inset	3+15%	5+15%	3+15%		5+15%	3+15%	6+15%
Caldera 	3	5	3		5	3	6
Daxton	2	4	2		4	2	6
Daxton Beaded Inset	2+15%	4+15%	2+15%		4+15%	2+15%	6+15%
Daxton Inset	2+15%	4+15%	2+15%		4+15%	2+15%	6+15%
Gunther	1	3	1		3	1	5
Gunther Beaded Inset	1+15%	3+15%	1+15%		3+15%	1+15%	5+15%
Gunther Inset	1+15%	3+15%	1+15%		3+15%	1+15%	5+15%
Karis	1	3	1		3	1	5
Karis Beaded Inset	1+15%	3+15%	1+15%		3+15%	1+15%	5+15%
Karis Inset	1+15%	3+15%	1+15%		3+15%	1+15%	5+15%
Langley	5	6	5		6	5	7
Langley Beaded Inset	5+15%	6+15%	5+15%		6+15%	5+15%	7+15%
Langley Inset	5+15%	6+15%	5+15%		6+15%	5+15%	7+15%
Montgomery 	1	3	1		3	1	5
Montgomery Beaded Inset 	1+15%	3+15%	1+15%		3+15%	1+15%	5+15%
Montgomery Inset 	1+15%	3+15%	1+15%		3+15%	1+15%	5+15%
Shona	1	3	1		3	1	5
Shona Beaded Inset	1+15%	3+15%	1+15%		3+15%	1+15%	5+15%
Shona Inset	1+15%	3+15%	1+15%		3+15%	1+15%	5+15%
Sumner 	3	5	3		5	3	6
Tackett	2	4	2		4	2	6
Tackett Beaded Inset	2+15%	4+15%	2+15%		4+15%	2+15%	6+15%
Tackett Inset	2+15%	4+15%	2+15%		4+15%	2+15%	6+15%
Trystan 	4	6	4	1	6		7
Trystan Beaded Inset 				1+15%			
Trystan Inset 				1+15%			
Vesta	2	4	2		4	2	6
Vesta Beaded Inset	2+15%	4+15%	2+15%		4+15%	2+15%	6+15%
Vesta Inset	2+15%	4+15%	2+15%		4+15%	2+15%	6+15%
Wells 	4	6	4		6	4	7

Diamond Edge Modification Option Descriptions

Your Diamond Edge price guide contains charts with modification option codes for each applicable cabinetry product. Reference the listing below to identify the modification description.

Door & Drawer Options	
Option	Description
AF	Aluminum Door
AOMBWB	Automatic Opening Mechanism for Wastebaskets
CC	Craftsman Door
CG	Cut-for-glass
GAMD	Gallery Mullion Door
IFHG	Inset Finial Hinges
MD	Mullion Door
PRMD	Prairie Mullion Door
PTOWB	Push-to-Open Wastebasket
SHMD	Shaker Mullion Door
SPLITDR	Split Doors
SPLITDRWS	Split Drawers
TCP	Transom w/both sections Center Panels

End Panel Options	
Option	Description
AUTH	Authentic Flush End
CSFPE	Car Siding Flush Panel End
EXBK	End Extended Back
FFD	Face Frame and Door on End
FL/FR	Finished Ends
FPE	Flush Panel End
INTGE	Integral End
IPE	Inset Panel Ends

Custom Modification Options	
Option	Description
ADD_SHLF	Add Shelf
ADDTK	Add Toekick
CBO	Cabinet Box Only
CCO	Cabinet Case Only
CFNTO	Cabinet Front Only
CFP	Cabinet False Panel
CFRMO	Cabinet Frame Only
CHGDRW	Charging Drawer
CLIP	Clipped Corner
CMAT	CabMat™
CND	Cabinet No Door
CSDGBK	Car Siding Back
DRT	Deep Roll Trays
DRWSEC	Secured Drawer
DRWTK	Toekick Drawer
EX	Extended Stile
EX_OL	Extended Stile with Overlay
FBFL	Finished Blind
FD	Full Depth Shelf
FDSRTBTM	Roll Tray Bottom with Full Depth Shelf
FLUT	Fluting
FTK	Flush Toekick
ID	Increased Depth
IH	Increased Height
INVFRM	Inverted Frame
IW	Increased Width
LIGHT	Lighting
MIP	Matching Interior
OBRB	Open Bottom Rail Base
PFINBTMB	Finished Bottom
RD	Reduced Depth
RECTK	Recessed Toekick
RECTK_6	Recessed Toekick — 6"
RECTKFRT6	Recessed Toekick Front — 6"
RH	Reduced Height
ROSLUT	Rose Fluting
RT	Roll Trays
RW	Reduced Width
SBCADDY	Sink Base Cleaning Caddy
SBCADDYSM	Sink Base Cleaning Caddy Small
SCPDRW	Scooped Drawer
SRT	Scooped Roll Tray
STW	Stacked Wall Cabinet Heights
TD	Tray Divider
TKP	Toekick Pedestal
TVR	Top Valance Rail
UDBX	U-shaped Drawer Box
URT	U-shaped Roll Tray
VTK	Void Toekick
WS	Wide Stiles
WTCDD	Wood Tiered Cutlery Divider Drawer
WTKCUP	Wood Tiered K-Cup Drawer
WTR	Wide Top Rail

BASE, 34 1/2" HIGH, 24" DEEP

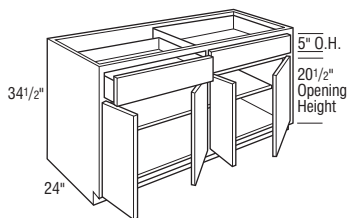
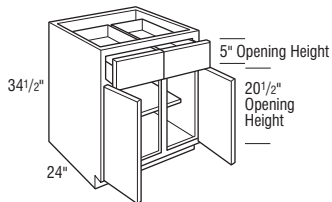
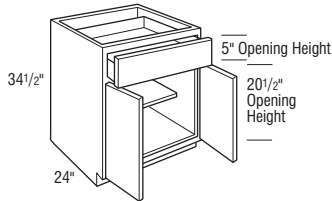
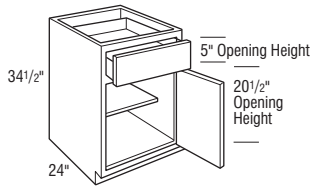

	Cubic Feet	1	2	3	4	5	6	7
B9 L or R	5.8	971	1017	1046	1105	1166	1268	1370
B12 L or R	7.5	1001	1048	1089	1148	1215	1324	1433
B15 L or R	9.1	1079	1137	1179	1241	1303	1431	1559
B18 L or R	10.8	1111	1161	1201	1266	1332	1460	1588
B21 L or R	12.4	1167	1224	1268	1338	1410	1543	1676
B24 L or R	14.1	1215	1272	1315	1389	1457	1586	1715
B24	14.1	1506	1578	1624	1712	1818	1988	2158
B27	15.7	1668	1752	1815	1914	2015	2206	2397
B30	17.4	1725	1810	1870	1977	2074	2272	2470
B33	19.0	1771	1858	1926	2033	2134	2331	2528
B36	20.7	1818	1908	1977	2086	2195	2398	2601
B39	22.4	1854	1946	2014	2128	2235	2439	2643
B42	24.0	1907	1998	2070	2187	2305	2514	2723
B45	25.7	2010	2109	2187	2309	2430	2656	2882
B48CS	27.3	2097	2197	2276	2406	2530	2765	3000
B48	27.3	2307	2417	2504	2647	2783	3042	3301

• Two sets of butt doors.

Notes below apply to all products in section above:

- One adjustable 15" deep shelf.
- Reduced Depths available in 1/4" increments from 12" to 23 3/4".

Door & Drawer Options

AF	AOMBWB	CC	CG	GAMD	IFHG	MD	PRMD ¹	PTOWB	SHMD ²	SPLITDR ³	SPLITDRWS ⁴	TCP

End Panel Options

AUTH	CSFPE	EXBK	FFD	FL/FR	FPE	INTGE	IPE

Custom Modification Options

ADD_SHLF	ADDTK	CBO	CCO	CFNT0	CFP	CFRMO	CHGDRW ⁵	CLIP ⁶	CMAT	CND	CSDGBK	DRT	DRWSEC ⁷	DRWTK ⁸	EX	EX_OL	FBFL	FD	

FDSRTBTM ²	FLUT ⁹	FTK ¹⁰	ID	IH	INVFRM	IW ¹¹	LIGHT	MIP	OBRB	PFINBTMB	RD	RECTK	RECTK	6 ¹²	RECTKFR ⁶	RH	ROSFLUT	RT ²	

RW	SBCADDY ²	SBCADDYSM ¹	SCPDRW	SRT	STW	TD	TKP	TVR ¹³	UDBX ¹⁴	URT	VTK	WS ¹⁵	WTC ¹⁶	WTKCUP ¹⁷	WTR ¹⁸

- ¹ Not available on 9" or 12" wide.
- ² Not available on 9" wide.
- ³ Only available on 24" (2 doors)-39" wide.
- ⁴ Only available on 24" (1 and 2 doors)-39" wide.
- ⁵ Only available with 36" wide. 36" wide only available in conjunction with SPLITDRWS modification.
- ⁶ Not available on 9", 12" or 24" (2 doors) wide.
- ⁷ Not available on 9"-15", 27"-39", or 45" wide.
- ⁸ Only available on 24" (1 and 2 doors), 30" and 36" wide.
- ⁹ 6" fluting not available on 9", 12", 15", or 24" (2 doors) wide. 6" fluting both not available on 18" or 21" wide.
- ¹⁰ FTKAV and style B-L not available on 9" or 12" wide.
- ¹¹ Not available on 24" (1 door) or 48" wide.
- ¹² 9" and 12" wide can only be recessed in front and/or back. 15" and 18" wide can only be recessed in the front, back, and/or one side only.
- ¹³ Not available on 18", 21", 24" (2 doors), or 27" wide. TVRAV and style B-L not available on 12", 42" or 45" wide.
- ¹⁴ Only available on 24" (1 and 2 doors)-39" and 48" wide.
- ¹⁵ Not available on 9" or 24" (2 doors) wide. Wide stile 3" both not available on 12" wide.
- ¹⁶ Only available on 30", 36", 42", and 48" wide.
- ¹⁷ Only available on 21", 24" (1 door and 2 doors) and 36" wide.
- ¹⁸ Only available on 36" wide.

Base Cabinets

BASE BUFFET, 34 1/2" HIGH, 24" DEEP

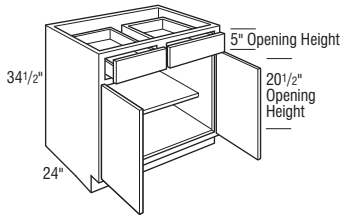

	Cubic Feet	1	2	3	4	5	6	7
B30B	17.4	1725	1810	1870	1977	2074	2272	2470
B33B	19.0	1771	1858	1926	2033	2134	2331	2528
B36B	20.7	1818	1908	1977	2086	2195	2398	2601

- One adjustable 15" deep shelf.
- Reduced Depths available in 1/4" increments from 12" to 23 3/4".
- Reveal between drawers will not align with doors below.

Door & Drawer Options

AF	AOMBWB	CC	CG	GAMD	IFHG	MD	PRMD	PTOWB	SHMD	SPLITDR	SPLITDRWS	TCP
			✓	✓	✓	✓	✓			✓		

End Panel Options

AUTH	CSFPE	EXBK	FFD	FL/FR	FPE	INTGE	IPE
✓	✓	✓	✓	✓	✓	✓	✓

Custom Modification Options

ADD	SHLF	ADTK	CBO	CCO	CFNT0	CFP	CFRMO	CHGDRW ¹	CLIP	CMAT	CND	CSDGBK	DRT	DRWSEC ¹	DRWTK	EX	EX_OL	FBFL	FD	
			✓	✓	✓	✓	✓	✓	✓	✓	✓	✓	✓	✓	✓	✓	✓	✓	✓	✓

FDSRTBTM	FLUT	FTK	ID	IH	INVFRM	IW	LIGHT	MIP	OBRB	PFINBTMB	RD	RECTK	RECTK_6	RECTKFT6	RH	ROSLUT	RT
✓	✓	✓	✓	✓	✓	✓	✓	✓	✓	✓	✓	✓	✓	✓	✓	✓	✓

RW	SBCADDY	SBCADDYSM	SCPRDW	SRT	STW	TD	TKP	TVR	UDBX	URT	VTK	WS	WTCD ²	WTKCUP ¹	WTR
✓	✓	✓	✓	✓	✓	✓	✓	✓	✓	✓	✓	✓	✓	✓	✓

¹ Only available on 36" wide.

² Only available on 30" and 36" wide.

BASE with BREAD BOARD, 34 1/2" HIGH, 24" DEEP

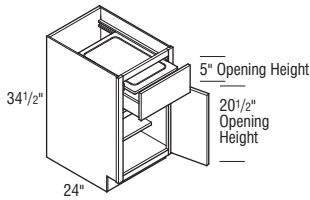

B12BB L or R	7.5	1463	1534	1586	1672	1749	1908	2067
B15BB L or R	9.1	1536	1609	1668	1752	1856	2030	2204
B18BB L or R	10.8	1628	1710	1759	1856	1961	2139	2317
B21BB L or R	12.4	1736	1822	1887	1987	2102	2296	2490
B24BB L or R	14.1	1869	1958	2035	2139	2257	2470	2683

B24BB*	14.1	2287	2399	2482	2618	2774	3031	3288
B30BB L or R	17.4	2291	2404	2485	2620	2779	3034	3289
B36BB L or R	20.7	2425	2545	2631	2779	2941	3213	3485
B42BB L or R	24.0	2678	2807	2908	3064	3245	3548	3851
B48BB L or R	27.3	2917	3058	3169	3337	3536	3865	4194

- L or R must be specified to denote Bread Board location.

Notes below apply to all products in section above:

- One adjustable 15" deep shelf.
- *One drawer - two doors; butt doors standard.

Door & Drawer Options

AF	AOMBWB	CC	CG	GAMD	IFHG	MD	PRMD ¹	PTOWB	SHMD	SPLITDR	SPLITDRWS	TCP
			✓	✓	✓	✓	✓			✓		

End Panel Options

AUTH	CSFPE	EXBK	FFD ²	FL/FR	FPE	INTGE	IPE
✓	✓	✓	✓	✓	✓	✓	✓

Custom Modification Options

ADD	SHLF	ADTK	CBO	CCO	CFNT0	CFP ²	CFRMO	CHGDRW	CLIP ³	CMAT	CND	CSDGBK	DRT	DRWSEC	DRWTK ⁴	EX	EX_OL	FBFL	FD
			✓	✓	✓	✓	✓	✓	✓	✓	✓	✓	✓	✓	✓	✓	✓	✓	✓

FDSRTBTM	FLUT ⁵	FTK ⁶	ID	IH	INVFRM	IW	LIGHT	MIP	OBRB	PFINBTMB	RD	RECTK	RECTK_6 ⁷	RECTKFT6	RH	ROSLUT	RT
✓	✓	✓	✓	✓	✓	✓	✓	✓	✓	✓	✓	✓	✓	✓	✓	✓	✓

RW	SBCADDY	SBCADDYSM ¹	SCPRDW ⁸	SRT	STW	TD	TKP	TVR ⁹	UDBX	URT	VTK	WS ¹⁰	WTCD	WTKCUP ¹¹	WTR ¹²
✓	✓	✓	✓	✓	✓	✓	✓	✓	✓	✓	✓	✓	✓	✓	✓

¹ Not available on 12" wide.

² Not available on 12"-24" (1 door and 2 doors) wide.

³ 3" clipped corners available on 15"-24" (1 door) wide.

⁴ Only available on 24" (1 door and 2 doors)-36" wide.

⁵ 6" fluting not available on 12", 15" or 24" (2 doors) and fluting both 6" not available on 12"-36" wide.

⁶ FTKAV and style B-L not available on 12" wide.

⁷ 12" wide can only be recessed in front and/or back. 15" and 18" wide can only be recessed in the front, back, and/or one side only.

⁸ Not available on 12"-24" (1 door) wide.

⁹ Not available on 18"-21" or 24" (2 doors) wide. TVRAV and style B-L not available on 36" or 42" wide.

¹⁰ Not available on 12" or 30" wide. Not available on wide stile 1.5" except on the wide stile both 1.5". 36"-48" wide only available on wide stile both 3".

¹¹ Only available on 36" wide.

¹² Not available on 18", 21", or 24" (2 doors) wide.

IH/RH availability charts starting on page G-40.
IW/RW availability charts starting on page G-46.

BASE with CHARGING DRAWER, 34 1/2" HIGH, 24" DEEP L G I X

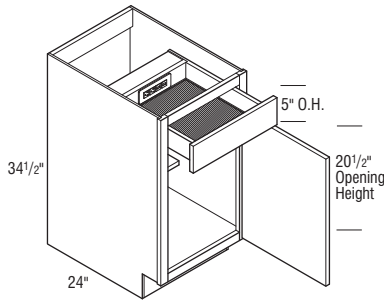

Cubic Feet	1	2	3	4	5	6	7	
B18CHGDRW L or R	10.8	2361	2411	2451	2516	2582	2710	2838

- One adjustable 15" deep shelf.
- Charging drawer has full extension, concealed Smart Stop slides.
- 110 lb. rated.
- 120V outlet must be installed in rear of cabinet within 10" of bottom of drawer, in rear of cabinet.
- CUL US listed power strip with two 120V plugs and two 2.1 amp USB ports.
- Max Current: AC 15 amps @ 120VAC; USB 2.1 amp and 5 VDC each.
- Tamper resistant outlets.
- Power cord with NEMA 5-15 plug.
- Integrated cord guide mounts to cabinet side to ensure safe operation.
- Black, shock absorbing mat included.
- Special sizes not available.
- Only available in 24" deep.
- Not available on Inset or Beaded Inset Styles.

Door & Drawer Options

AF	AOMBWB	CC	CG	GAMD	IFHG	MD	PRMD	PTOWB	SHMD	SPLITDR	SPLITDRWS	TCP
		✓	✓	✓		✓	✓		✓			

End Panel Options

AUTH	CSFPE	EXBK	FFD	FL/FR	FPE	INTGE	IPE
✓	✓	✓	✓	✓	✓	✓	✓

Custom Modification Options

ADD	SHLF	ADDTK	CBO	CCO	CFNT0	CFP	CFRMO	CHGDRW	CLIP	CMAT	CND	CSDGBK	DRT	DRWSEC	DRWTK	EX	EX_OL	FBFL	FD
			✓	✓	✓		✓				✓	✓			✓	✓	✓	✓	

FDSRTBTM	FLUT	FTK	ID	IH	INVFRM	IW	LIGHT	MIP	OBRB	PFINBTMB	RD	RECTK	RECTK_6 ¹	RECTKFRT6	RH	ROSLUT	RT
		✓	✓	✓				✓	✓				✓	✓			

RW	SBCADDY	SBCADDYSM	SCPDRW	SRT	STW	TD	TKP	TVR	UDBX	URT	VTK	WS	WTCD	WTKCUP	WTR
							✓	✓			✓				✓

¹ Can only be recessed in the front, back, and/or one side only.

Base Cabinets

BASE with ROLL TRAYS, 34 1/2" HIGH, 24" DEEP

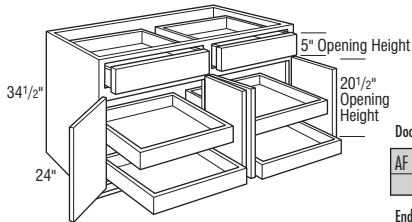
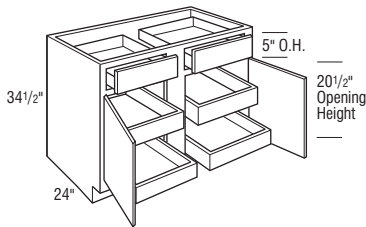
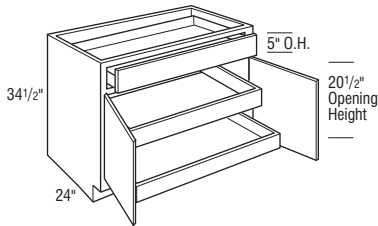
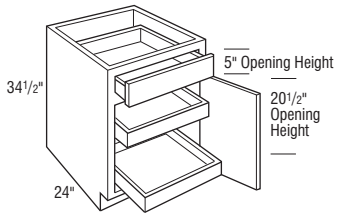

	Cubic Feet	1	2	3	4	5	6	7
B12RT L or R	7.5	1779	1826	1869	1925	1990	2104	2218
B15RT L or R	9.1	1858	1914	1957	2017	2080	2209	2338
B18RT L or R	10.8	1888	1940	1979	2046	2110	2239	2368
B21RT L or R	12.4	1947	2004	2047	2117	2188	2320	2452
B24RT L or R	14.1	1990	2051	2094	2165	2235	2366	2497

• Contains two easily adjustable roll trays.

B24RT	14.1	2282	2358	2401	2489	2596	2767	2938
B27RT	15.7	2447	2530	2591	2690	2792	2981	3170
B30RT	17.4	2506	2587	2649	2756	2854	3050	3246
B33RT	19.0	2549	2635	2708	2812	2913	3111	3309
B36RT	20.7	2596	2685	2756	2864	2972	3176	3380

• Contains two easily adjustable roll trays.

B39RT	22.4	3367	3459	3528	3643	3748	3954	4160
B42RT	24.0	3420	3512	3586	3700	3818	4028	4238
B45RT	25.7	3524	3624	3700	3825	3944	4169	4394
B48CSRT	27.3	3611	3711	3790	3921	4045	4281	4517

• Includes four easily adjustable roll trays and center mullion.
• 39" wide and wider will receive two easily adjustable roll trays in the width.

B48RT	27.3	3972	4082	4169	4313	4450	4709	4968
--------------	------	------	------	------	------	------	------	------

• Two sets of butt doors.
• Includes four easily adjustable roll trays and center mullion.

Notes below apply to all products in section above:

- Reduced Depths available in 1/4" increments from 12" to 23 3/4".
- Exceptions may apply when using IW with Clipped Corners or Wide Stiles. Please reference these sections in Section G for more details.

Door & Drawer Options

AF	AOMBWB	CC	CG	GAMD	IFHG	MD	PRMD ¹	PTOWB	SHMD	SPLITDR	SPLITDRWS ²	TCP
			✓	✓	✓	✓	✓		✓		✓	

End Panel Options

AUTH	CSFPE	EXBK	FFD	FL/FR	FPE	INTGE	IPE
✓	✓	✓	✓	✓	✓	✓	✓

Custom Modification Options

ADD	SHLF	ADDTK	CBO	CCO ³	CFNT0	CFP	CFRMO	CHGDRW ⁴	CLIP ⁵	CMAT	CND	CSDGBK	DRT	DRWSEC ⁶	DRWTK ⁷	EX	EX_OL	FBFL	FD	
				✓	✓	✓	✓	✓	✓	✓	✓	✓	✓	✓	✓	✓	✓	✓	✓	✓

FDSRTBTM	FLUT ⁸	FTK ⁹	ID	IH	INVERM	IW ¹⁰	LIGHT	MIP	OBRB	PFINBTMB	RD	RECTK	RECTK_6 ¹¹	RECTKFR6	RH	ROSFLUT	RT ¹²
	✓	✓	✓	✓	✓	✓	✓	✓	✓	✓	✓	✓	✓	✓	✓	✓	✓

RW	SBCADDY	SBCADDYSM	SCPDW	SRT	STW	TD	TKP	TVR ¹³	UDBX ¹⁴	URT ¹⁴	VTK	WS ¹⁵	WTCD ¹⁶	WTKCUP ¹⁷	WTR
			✓	✓	✓	✓	✓	✓	✓	✓	✓	✓	✓	✓	✓

¹ Not available on 12" wide.

² Only available on 24"-36" wide.

³ Not available on 30"-48" wide.

⁴ Only available with 36" wide. 36" wide only available in conjunction with SPLITDRWS modification.

⁵ Not available on 9" or 24" (2 doors) wide.

⁶ Not available on 12", 15", 27"-36", 39", or 45" wide.

⁷ Only available on 24" (1 door), 30" and 36" wide.

⁸ 6" fluting not available on 12", 15", 42", or 48" wide. 6" fluting both not available on 18"-24" (1 door and 2 doors) wide.

⁹ FTKAV and style B-L not available on 12" wide.

¹⁰ Not available on 24" (1 door and 2 doors) wide.

¹¹ 12" wide can only be recessed in front and/or back. 15" and 18" wide can only be recessed in the front, back, and/or one side only.

¹² Not available on 39" or 45" wide.

¹³ Not available on 39"-48" wide and TVRAV and style B-L not available on 12" wide.

¹⁴ Not available on 12"-21" or 39"-45" wide.

¹⁵ Only available on 30", 36", 42", and 48" wide.

¹⁶ Not available on 12", 27", 33", 36", 39", or 45" wide.

¹⁷ Only available on 36" wide.

IH/RH availability charts starting on page G-40.
IW/RW availability charts starting on page G-46.

BASE with ROLL TRAYS and CHARGING DRAWER, 34 1/2" HIGH, 24" DEEP L G I X

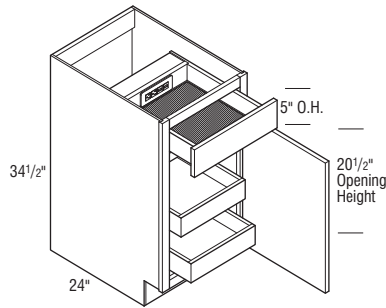

Cubic Feet	1	2	3	4	5	6	7	
B18CHGDRWRT L or R	10.8	3138	3190	3229	3296	3360	3489	3618

- Contains two easily adjustable roll trays.
- Charging drawer has full extension, concealed Smart Stop slides.
- 110 lb. rated.
- 120V outlet must be installed in rear of cabinet within 10" of bottom of drawer, in rear of cabinet.
- CUL US listed power strip with two 120V plugs and two 2.1 amp USB ports.
- Max Current: AC 15 amps @ 120VAC; USB 2.1 amp and 5 VDC each.
- Tamper resistant outlets.
- Power cord with NEMA 5-15 plug.
- Integrated cord guide mounts to cabinet side to ensure safe operation.
- Black, shock absorbing mat included.
- Special sizes not available.
- Only available in 24" deep.
- Not available on Inset or Beaded Inset Styles.

Door & Drawer Options

AF	AOMBWB	CC	CG	GAMD	IFHG	MD	PRMD	PTOWB	SHMD	SPLITDR	SPLITDRWS	TCP
			✓	✓		✓	✓		✓			

End Panel Options

AUTH	CSFPE	EXBK	FFD	FL/FR	FPE	INTGE	IPE
✓	✓	✓	✓	✓	✓	✓	✓

Custom Modification Options

ADD_SHLF	ADDTK	CBO	CCO	CFNTD	CFP	CFRMO	CHGDRW	CLIP	CMAT	CND	CSDGBK	DRT	DRWSEC	DRWTK	EX	EX_OL	FBFL	FD
			✓	✓	✓	✓		✓		✓	✓	✓	✓	✓	✓	✓	✓	✓

FDSRTBTM	FLUT ¹	FTK	ID	IH	INVFRM	IW	LIGHT	MIP	OBRB	PFINBTMB	RD	RECTK	RECTK_6 ²	RECTKRT6	RH	ROSFLUT	RT
	✓	✓						✓	✓			✓	✓	✓	✓	✓	✓

RW	SBCADDY	SBCADDYSM	SCPDRW	SRT	STW	TD	TKP	TVR	UDBX	URT	VTK	WS ³	WTCD	WTKCUP	WTR
				✓				✓	✓		✓	✓	✓		✓

¹ Not available with 6" fluting or fluting both.

² Can only be recessed in the front, back, and/or one side only.

³ Not available with WSR1.5, WSL1.5, WSL&R3.

BASE with WOOD TIERED CUTLERY DIVIDER, 34 1/2" HIGH, 24" DEEP L G I X

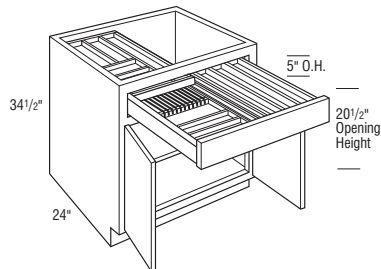
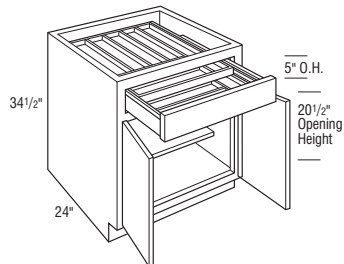
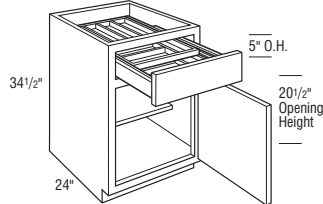

B15WTCD L or R	9.1	1608	1662	1709	1769	1829	1957	2085
-----------------------	-----	------	------	------	------	------	------	------

B18WTCD L or R	10.8	1640	1687	1728	1795	1860	1987	2114
-----------------------	------	------	------	------	------	------	------	------

B21WTCD L or R	12.4	1698	1752	1796	1864	1940	2070	2200
-----------------------	------	------	------	------	------	------	------	------

B24WTCD L or R	14.1	1743	1802	1843	1917	1983	2117	2251
-----------------------	------	------	------	------	------	------	------	------

B24WTCD	14.1	2033	2106	2153	2240	2347	2517	2687
----------------	------	------	------	------	------	------	------	------

B30WTCD	17.4	2625	2710	2770	2877	2974	3172	3370
----------------	------	------	------	------	------	------	------	------

B36WTCD	20.7	2718	2808	2877	2986	3095	3298	3501
----------------	------	------	------	------	------	------	------	------

Notes below apply to all products in section above:

- One adjustable 15" deep shelf.
- Exterior WTCD drawer box height is 3 3/4", interior height of top and bottom tier is 1 3/8".
- Different sizes of the cutlery dividers may have different configurations. Please reference the accessory section on page 5 for more details.

Door & Drawer Options

AF	AOMBWB	CC	CG	GAMD	IFHG	MD	PRMD	PTOWB	SHMD	SPLITDR	SPLITDRWS	TCP
			✓	✓	✓	✓	✓		✓			

End Panel Options

AUTH	CSFPE	EXBK	FFD	FL/FR	FPE	INTGE	IPE
✓	✓	✓	✓	✓	✓	✓	✓

Custom Modification Options

ADD_SHLF	ADDTK	CBO	CCO	CFNTD	CFP	CFRMO	CHGDRW	CLIP ¹	CMAT	CND	CSDGBK	DRT	DRWSEC	DRWTK ²	EX	EX_OL	FBFL	FD
			✓	✓	✓	✓		✓		✓	✓	✓	✓	✓	✓	✓	✓	✓

FDSRTBTM	FLUT ³	FTK	ID	IH	INVFRM	IW	LIGHT	MIP	OBRB	PFINBTMB	RD	RECTK	RECTK_6 ⁴	RECTKRT6	RH	ROSFLUT	RT
	✓	✓						✓	✓			✓	✓	✓	✓	✓	✓

RW	SBCADDY	SBCADDYSM	SCPDRW	SRT	STW	TD	TKP	TVR	UDBX	URT	VTK	WS ⁵	WTCD	WTKCUP	WTR
				✓				✓	✓		✓	✓	✓		✓

¹ Not available on 15" or 24" (2 doors) wide.

² Not available on 15"-21" wide.

³ 6" fluting not available on 15", 18" or 24" (2 doors) wide and not available with 6" fluting both.

⁴ 15" and 18" wide can only be recessed in the front, back, and/or one side only.

⁵ Not available on 15" or 24" (2 doors) wide. Not available with wide stiles 1.5" except wide stile both 1.5". Wide stile both 3" only available on 24" (1 door) wide.

Base Cabinets

BASE with WOOD TIERED CUTLERY DIVIDER and ROLL TRAYS, 34 1/2" HIGH, 24" DEEP

L G I X

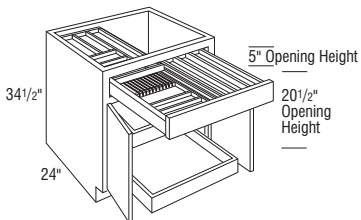
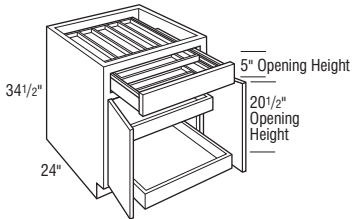
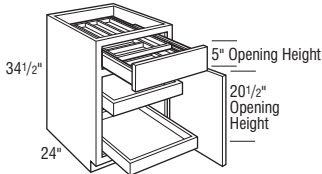

	Cubic Feet	1	2	3	4	5	6	7
B15RTWCD L or R	9.1	2358	2414	2457	2517	2580	2709	2838
B18RTWCD L or R	10.8	2388	2440	2479	2546	2610	2739	2868
B21RTWCD L or R	12.4	2847	2904	2947	3017	3088	3220	3352
B24RTWCD L or R	14.1	2890	2951	2994	3065	3135	3266	3397
B24RTWCD	14.1	3336	3455	3545	3689	3852	4126	4400
B30RTWCD	17.4	3406	3487	3549	3656	3754	3950	4146
B36RTWCD	20.7	3496	3585	3656	3764	3872	4076	4280

Notes below apply to all products in section above:

- Two roll trays standard.
- Includes Wood Tiered Cutlery Divider Drawer.
- Exterior WTC drawer box height is 3 3/4", interior height of top and bottom tier is 1 3/8".
- Cabinet may accommodate up to four roll trays, which may be purchased separately for field installation. See page S•9.
- Wood Tiered Cutlery Divider Drawer is also available as an accessory for field installation. See page S•5.
- Different sizes of the cutlery dividers may have different configurations. Please reference the accessory section on page S•5 for more details.

Door & Drawer Options

AF	AOMBWB	CC	CG	GAMD	IFHG	MD	PRMD	PTOWB	SHMD	SPLITDR	SPLITDRWS	TCP
			✓	✓	✓	✓	✓		✓			

End Panel Options

AUTH	CSFPE	EXBK	FFD ¹	FL/FR	FPE	INTGE	IPE
✓	✓		✓	✓	✓	✓	✓

Custom Modification Options

ADD	SHLF	ADDTK	CBO	CCO	CFNT0	CFP	CFRMO	CHGDRW	CLIP ²	CMAT	CND	CSDGBK	DRT	DRWSEC	DRWTK	EX	EX_OL	FBFL	FD
			✓	✓					✓			✓	✓	✓	✓			✓	
FDSRTBTM	FLUT ³	FTK ⁴	ID	IH	INVFRM	IW	LIGHT	MIP	OBRB	PFINBTMB	RD	RECTK	RECTK_6 ⁴	RECTKFRT6	RH	ROSEFLUT ⁵	RT		
	✓	✓						✓	✓			✓	✓	✓	✓	✓			
RW	SBCADDY	SBCADDYSM	SCPDRW	SRT	STW	TD	TKP	TVR	UDBX	URT	VTK	WS ⁵	WTC	WTKCUP	WTR				
				✓				✓	✓			✓	✓						

¹ Only available on 30" and 36" wide.

² Clipped both and Clipped 6" not available on 15" or 18" wide. Clipped both 6" only available on 30" and 36" wide. Not available on CLPL and CLPR not available on 30" or 36" wide.

³ Fluting both and 6" fluting not available on 15" or 18" wide. Fluting both 6" only available on 30" and 36" wide. Not available on FLUT3L and FLUT3R not available on 30" or 36" wide.

⁴ 15" and 18" wide can only be recessed in the front, back, and/or one side only.

⁵ Not available on 15" wide. WSL&R3 not available on 15" or 18" wide.

IH/RH availability charts starting on page G•40.
IW/RW availability charts starting on page G•46.

BASE with CUTLERY INSERT WOOD DIVIDERS, 34 1/2" HIGH, 24" DEEP

L G I X

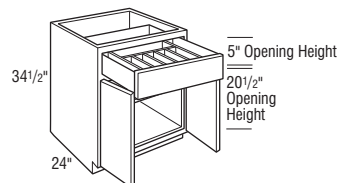
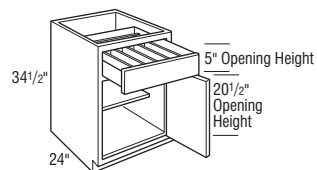

	Cubic Feet	1	2	3	4	5	6	7
B15CIW L or R	9.1	1197	1255	1297	1359	1421	1549	1677
B18CIW L or R	10.8	1229	1279	1319	1384	1450	1578	1706
B21CIW L or R	12.4	1312	1369	1413	1483	1555	1688	1821
B24CIW L or R	14.1	1392	1449	1492	1566	1634	1763	1892

B24CIW	14.1	1683	1755	1801	1889	1995	2165	2335
---------------	------	------	------	------	------	------	------	------

Notes below apply to all products in section above:

- One adjustable 15" deep shelf.
- Includes Cutlery Insert Wood Divider.
- Features hard wood.
- Cutlery Insert Wood Divider is also available as an accessory for field installation. See page S•5.

Door & Drawer Options

AF	AOMBWB	CC	CG	GAMD	IFHG	MD ¹	PRMD ¹	PTOWB	SHMD	SPLITDR	SPLITDRWS ²	TCP
		✓			✓	✓	✓				✓	

End Panel Options

AUTH	CSFPE	EXBK	FFD	FL/FR	FPE	INTGE	IPE
✓	✓	✓	✓	✓	✓	✓	✓

Custom Modification Options

ADD_SHLF	ADDTK	CBO	CCO	CFNTO	CFP	CFRMO	CHGDRW	CLIP ¹	CMAT	CND	CSDBGK	DRT	DRWSEC	DRWTK	EX	EX_OL	FBFL	FD
			✓	✓	✓	✓		✓		✓	✓	✓		✓	✓	✓	✓	✓

FDSRTBTM	FLUT ³	FTK	ID	IH	INVERM	IW ⁴	LIGHT	MIP	OBRB	PFINBTMB	RD	RECTK	RECTK_6 ⁵	RECTKFR6	RH	ROSFLUT	RT
✓	✓	✓	✓	✓	✓	✓	✓	✓	✓	✓	✓	✓	✓	✓	✓	✓	✓

RW	SBCADDY ¹	SBCADDYSM	SCPDWR	SRT	STW	TD	TKP	TVR ⁶	UDBX	URT	VTK	WS ¹	WTCD	WTKCUP ¹	WTR
✓	✓	✓	✓	✓	✓	✓	✓	✓	✓	✓	✓	✓	✓	✓	✓

¹ Not available on 24" (2 doors) wide.

² Only available on 24" (1 door) wide.

³ 6" fluting not available on 15" or 24" (2 doors) wide, and FLUT6B is only available on 24" (1 door) wide.

⁴ Not available on 24" wide.

⁵ 15" and 18" wide can only be recessed in the front, back, and/or one side only.

⁶ Not available on 18", 21" or 24" (2 doors) wide.

Base Cabinets

BASE with CUTLERY INSERT WOOD DIVIDERS and ROLL TRAYS, 34 1/2" HIGH, 24" DEEP

L G I X

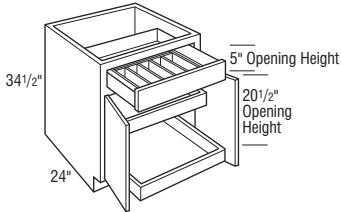
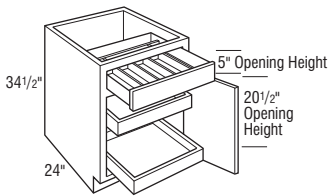

	Cubic Feet	1	2	3	4	5	6	7
B15RTCIW L or R	9.1	1976	2032	2075	2135	2198	2327	2456
B18RTCIW L or R	10.8	2006	2058	2097	2164	2228	2357	2486
B21RTCIW L or R	12.4	2092	2149	2192	2262	2333	2465	2597
B24RTCIW L or R	14.1	2167	2228	2271	2342	2412	2543	2674

B24RTCIW	14.1	2459	2535	2578	2666	2773	2944	3115
-----------------	------	------	------	------	------	------	------	------

Notes below apply to all products in section above:

- Two roll trays standard.
- Includes Cutlery Insert Wood Divider.
- Features hard wood.
- Cabinet may accommodate up to four roll trays, which may be purchased separately for field installation. See page S•9.
- Cutlery Insert Wood Divider is also available as an accessory for field installation. See page S•5.

Door & Drawer Options

AF	AOMBWB	CC	CG	GAMD	IFHG	MD	PRMD	PTOWB	SHMD	SPLITDR	SPLITDRWS ¹	TCP
			✓		✓	✓	✓				✓	

End Panel Options

AUTH	CSFPE	EXBK	FFD	FL/FR	FPE	INTGE	IPE
✓	✓	✓		✓	✓	✓	✓

Custom Modification Options

ADD	SHLF	ADDTK	CBO	CCO	CFNTO	CFP	CFRMO	CHGDRW	CLIP ²	CMAT	CND	CSDGBK	DRT	DRWSEC	DRWTK	EX	EX_OL	FBFL	FD	
	✓	✓	✓	✓	✓	✓	✓	✓	✓	✓	✓	✓	✓	✓	✓	✓	✓	✓	✓	✓

FDSRTBTM	FLUT ³	FTK	ID ²	IH	INVFRM	IW ⁴	LIGHT	MIP	OBRB	PFINBTMB	RD	RECTK	RECTK_6 ⁵	RECTKFRT6	RH	ROSLUT	RT	
✓	✓	✓	✓	✓	✓	✓	✓	✓	✓	✓	✓	✓	✓	✓	✓	✓	✓	✓

RW	SBCADDY	SBCADDYSM	SCPDRW	SRT	STW	TD	TKP	TVR	UBX ⁶	URT	VTK	WS ⁷	WTCD	WTKCUP	WTR
			✓	✓				✓	✓	✓	✓	✓		✓	✓

¹ Only available on 24" (1 door) wide.

² Not available on 24" (2 doors) wide.

³ 6" fluting not available on 15" wide and FLUT6B not available.

⁴ Not available on 24" (1 door) wide.

⁵ 15" and 18" wide can only be recessed in the front, back, and/or one side only.

⁶ Only available on 24" (2 doors) wide.

⁷ WSB3 not available on 15" wide and WSR1.5 and WSL1.5 not available on 24" (1 door) wide. Not available on 24" (1 door) wide.

BASE with WOOD TIERED K-CUP* DRAWER, 34 1/2" HIGH, 24" DEEP

L G I X

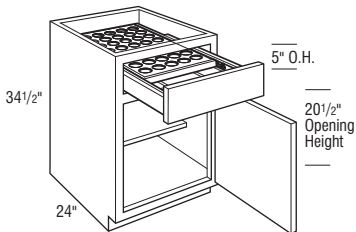

B18KUP L or R	10.8	1774	1853	1915	2020	2127	2331	2535
----------------------	------	------	------	------	------	------	------	------

- One adjustable 15" deep shelf.
- Holds 40 K-Cups.
- The Wood Tiered K-Cup Drawer is compatible with K-Cup pods only.
- Exterior Wood Tiered K-Cup drawer box height is 3 3/4", interior height of top tier is 1 5/8", and interior height of bottom tier is 1 3/8".

*K-Cup is a registered trademark of Keurig Green Mountain, Inc.

Door & Drawer Options

AF	AOMBWB	CC	CG	GAMD	IFHG	MD	PRMD	PTOWB	SHMD	SPLITDR	SPLITDRWS TCP
					✓				✓		

End Panel Options

AUTH	CSFPE	EXBK	FFD	FL/FR	FPE	INTGE	IPE
✓	✓	✓	✓	✓	✓	✓	✓

Custom Modification Options

ADD	SHLF	ADDTK	CBO	CCO	CFNTO	CFP	CFRMO	CHGDRW	CLIP	CMAT	CND	CSDGBK	DRT	DRWSEC	DRWTK	EX	EX_OL	FBFL	FD
	✓	✓	✓	✓	✓	✓	✓	✓	✓	✓	✓	✓	✓	✓	✓	✓	✓	✓	✓

FDSRTBTM	FLUT ¹	FTK	ID	IH	INVFRM	IW	LIGHT	MIP	OBRB	PFINBTMB	RD	RECTK	RECTK_6 ²	RECTKFRT6	RH	ROSLUT	RT	
✓	✓	✓	✓	✓	✓	✓	✓	✓	✓	✓	✓	✓	✓	✓	✓	✓	✓	✓

RW	SBCADDY	SBCADDYSM	SCPDRW	SRT	STW	TD	TKP	TVR	UBX	URT	VTK	WS	WTCD	WTKCUP	WTR
			✓	✓				✓	✓	✓	✓	✓		✓	✓

¹ Not available with 6" fluting.

² Can only be recessed in the front, back, and/or one side only.

IH/RH availability charts starting on page G•40.
IW/RW availability charts starting on page G•46.

BASE with WOOD TIERED K-CUP* DRAWER and ROLL TRAYS, 34 1/2" HIGH, 24" DEEP

L G I X

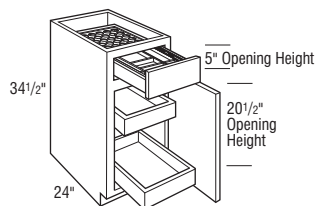

Cubic Feet	1	2	3	4	5	6	7	
B18KCUPRT L or R	10.8	2163	2215	2254	2321	2385	2514	2643

- Two roll trays standard.
- Cabinet may accommodate up to four roll trays, which may be purchased separately for field installation. See page S-9.
- Holds 40 K-Cups.
- The Wood Tiered K-Cup Drawer is compatible with K-Cup pods only.
- Exterior Wood Tiered K-Cup drawer box height is 3 3/4", interior height of top tier is 1 5/8", and interior height of bottom tier is 1 3/8".

*K-Cup is a registered trademark of Keurig Green Mountain, Inc.

Door & Drawer Options

AF	AOMBWB	CC	CG	GAMD	IFHG	MD	PRMD	PTOWB	SHMD	SPLITDR	SPLITDRWS	TCP
				✓	✓	✓	✓		✓			

End Panel Options

AUTH	CSFPE	EXBK	FFD	FL/FR	FPE	INTGE	IPE
✓	✓			✓	✓	✓	✓

Custom Modification Options

ADD_SHLF	ADDTK	CBO	CCO	CFNTD	CFP	CFRMO	CHGDRW	CLIP ¹	CMAT	CND	CSDGBK	DRT	DRWSEC	DRWTK	EX	EX_OL	FBFL	FD
	✓	✓	✓	✓			✓	✓			✓	✓	✓	✓	✓	✓	✓	✓

FDSRTBTM	FLUT ²	FTK	ID	IH	INVFRM	IW	LIGHT	MIP	OBRB	PFINBTMB	RD	RECTK	RECTK_6 ³	RECTKFR6	RH	ROSFLUT	RT
	✓							✓	✓			✓	✓	✓			

RW	SBCADDY	SBCADDYSM	SCPDRW	SRT	STW	TD	TKP	TVR	UDBX	URT	VTK	WS	WTCD	WTKCUP	WTR
				✓				✓	✓		✓				

¹ Not available with 6" clipped corners.

² Not available with fluting both or 6" fluting.

³ Can only be recessed in the front, back, and/or one side only.

BASE with FOOD STORAGE CONTAINER ORGANIZER, 34 1/2" HIGH, 24" DEEP

L G I X

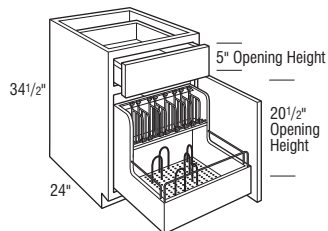

	10.8	2311	2361	2401	2466	2532	2660	2788
B18FSCO L or R								
B24FSCO L or R	14.1	3636	3755	3845	3989	4152	4426	4700

- Pull-out features natural finished hardwood dovetailed box with chrome rails on lower section with undermount Smart Stop guides.
- Includes seven chrome "U" pegs to use on the pegboard bottom to customize the fit to container sizes.
- Adjustable clip-on lid dividers included to fit with a variety of lid shapes. 18" wide includes five dividers, 24" wide includes eight dividers.
- Front of pull-out is routed for easy access.
- 18" wide cabinet pull-out dimensions: 14 1/2" W x 21 1/2" D x 18" H.
- 24" wide cabinet pull-out dimensions: 20 1/2" W x 21 1/2" D x 18" H.
- Not available on Inset and Beaded Inset styles.

Door & Drawer Options

AF	AOMBWB	CC	CG	GAMD	IFHG	MD	PRMD	PTOWB	SHMD	SPLITDR	SPLITDRWS	TCP
				✓	✓	✓	✓		✓			

End Panel Options

AUTH	CSFPE	EXBK	FFD	FL/FR	FPE	INTGE	IPE
✓	✓			✓	✓	✓	✓

Custom Modification Options

ADD_SHLF	ADDTK	CBO	CCO	CFNTD	CFP	CFRMO	CHGDRW ¹	CLIP	CMAT	CND	CSDGBK	DRT	DRWSEC	DRWTK	EX	EX_OL	FBFL	FD
	✓	✓	✓	✓			✓	✓			✓	✓	✓	✓	✓	✓	✓	✓

FDSRTBTM	FLUT	FTK	ID	IH	INVFRM	IW	LIGHT	MIP	OBRB	PFINBTMB	RD	RECTK	RECTK_6 ²	RECTKFR6	RH	ROSFLUT	RT
	✓							✓	✓			✓	✓	✓			

RW	SBCADDY	SBCADDYSM	SCPDRW	SRT	STW	TD	TKP	TVR	UDBX ³	URT	VTK	WS	WTCD	WTKCUP	WTR
									✓	✓	✓	✓			

¹ Only available on 18" wide.

² 18" wide can only be recessed in the front, back, and/or one side only.

³ Only available on 24" wide.

Base Cabinets

FULL HEIGHT BASE, 34 1/2" HIGH, 24" DEEP

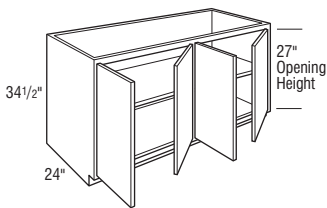
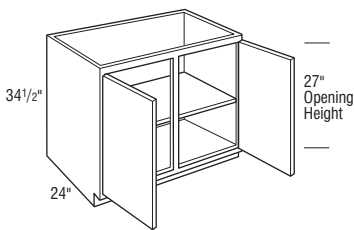
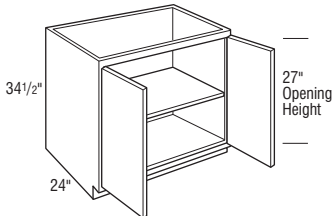
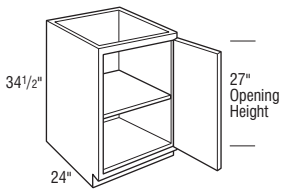

	Cubic Feet	1	2	3	4	5	6	7
B6FH L or R	4.1	939	984	1019	1075	1140	1246	1352
B9FH L or R	5.8	939	984	1019	1075	1140	1246	1352
B12FH L or R	7.5	989	1039	1074	1131	1196	1305	1414
B15FH L or R	9.1	1043	1089	1126	1192	1246	1357	1468
B18FH L or R	10.8	1079	1137	1181	1242	1313	1433	1553
B21FH L or R	12.4	1133	1192	1230	1299	1357	1485	1613
B24FH L or R	14.1	1181	1236	1281	1347	1417	1546	1675

B24FH	14.1	1474	1548	1586	1671	1785	1951	2117
B27FH	15.7	1524	1598	1655	1744	1832	2001	2170
B30FH	17.4	1679	1760	1822	1926	2045	2235	2425
B33FH	19.0	1726	1811	1875	1984	2088	2276	2464
B36FH	20.7	1789	1872	1936	2046	2165	2371	2577
B39FH	22.4	1818	1908	1977	2086	2195	2398	2601

B42FH	24.0	1881	1973	2040	2152	2276	2487	2698
B45FH	25.7	1970	2064	2136	2254	2378	2598	2818
B48FHCS	27.3	2052	2152	2227	2350	2465	2697	2929

B48FH	27.3	2257	2367	2450	2585	2712	2967	3222
--------------	------	------	------	------	------	------	------	------

• Two sets of butt doors.

Notes below apply to all products in section above:

- One adjustable Full Depth Shelf.
- Reduced Depths available in 1/4" increments from 6" to 23 3/4".
- Increased Depths available in 1/4" increments from 24 1/4" to 30".
- 6" not available with Insert or Beaded Inset styles.
- Utilizes a slab door on cabinets up to 9" wide.

Door & Drawer Options

AF ¹	AOMBWB	CC	CG ¹	GAMD ²	IFHG ¹	MD ²	PRMD ³	PTOWB	SHMD ²	SPLITDR ⁴	SPLITDRWS	TCP
✓	✓	✓	✓	✓	✓	✓	✓	✓	✓	✓	✓	✓

End Panel Options

AUTH	CSFPE	EXBK	FFD	FL/FR	FPE	INTGE ¹	IPE ¹
✓	✓	✓	✓	✓	✓	✓	✓

Custom Modification Options

ADD	SHLF	ADDTK	CBO	CCO	CFNTO	CFP	CFRMO	CHGDRW	CLIP ⁵	CMAT	CND	CSDGBK ¹	DRT	DRWSEC	DRWTK ⁶	EX	EX_OL	FBFL	FD
✓	✓	✓	✓	✓	✓	✓	✓	✓	✓	✓	✓	✓	✓	✓	✓	✓	✓	✓	✓

FDSRTBTM ²	FLUT ⁷	FTK ⁸	ID	IH	INVFRM	IW ⁹	LIGHT	MIP	ORRB	PFINBTMB	RD	RECTK ¹⁰	RECTK_6 ¹¹	RECTKFT6	RH	ROSFLUT ¹²	RT ¹
✓	✓	✓	✓	✓	✓	✓	✓	✓	✓	✓	✓	✓	✓	✓	✓	✓	✓

RW	SBCADDY ¹³	SBCADDYSM ¹⁴	SCPDRW	SRT	STW	TD ¹	TKP	TVR ¹⁰	UDBX	URT ¹⁵	VTK	WS ¹⁶	WTC	WTKCUP	WTR
✓	✓	✓	✓	✓	✓	✓	✓	✓	✓	✓	✓	✓	✓	✓	✓

¹ Not available on 6" wide.

² Not available on 6" or 9" wide.

³ Not available on 6", 9", 12", or 24" (2 doors) wide.

⁴ Only available on 30"-39" wide.

⁵ Not available on 6", 9", 12", or 24" (2 doors) wide.

⁶ Only available on 24" (1 door), 30" and 36" wide.

⁷ Not available on 24" (2 doors) or 27" wide. Fluting both 3" only available on 15"-21" wide. 6" fluting not available on 6"-21" wide and fluting both 6" not available.

⁸ FTKAV and style B-L not available on 6", 9" or 12" wide.

⁹ Not available on 48" wide.

¹⁰ Not available on 9", 42", 45", or 48" wide. TVRAV and style B-L not available on 6" or 12" wide.

¹¹ 6", 9", and 12" wide can only be recessed in front and/or back. 15" and 18" wide can only be recessed in the front, back, and/or one side only.

¹² Not available on 24" (2 doors) or 27" wide. Fluting both only available on 15"-21" wide.

¹³ Not available on 6", 9", 12", or 45" wide.

¹⁴ Not available on 6", 9" or 45" wide.

¹⁵ Only available on 24" (1 door and 2 doors)-36" wide.

¹⁶ Not available on 6"-9" wide and wide stile both 3" not available on 12" wide.

IH/RH availability charts starting on page G-40.
IW/RW availability charts starting on page G-46.

FULL HEIGHT BASE, 40 1/2" HIGH, 24" DEEP

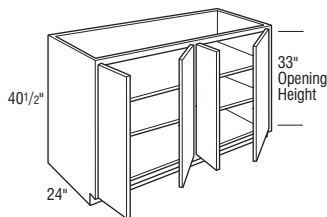
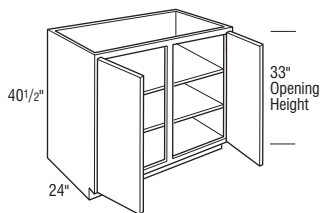
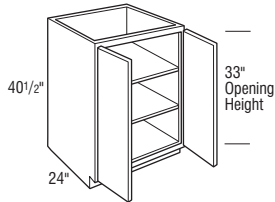
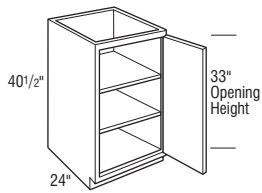

	Cubic Feet	1	2	3	4	5	6	7
B940FH L or R	6.3	1079	1124	1159	1215	1280	1386	1492
B1240FH L or R	8.2	1129	1179	1214	1271	1336	1445	1554
B1540FH L or R	10.0	1183	1229	1266	1332	1386	1497	1608
B1840FH L or R	11.9	1219	1277	1321	1382	1453	1573	1693
B2140FH L or R	13.8	1273	1332	1370	1439	1497	1625	1753
B2440FH L or R	15.6	1321	1376	1421	1487	1557	1686	1815

B2440FH	15.6	1614	1688	1726	1811	1925	2091	2257
B2740FH	17.5	1664	1738	1795	1884	1972	2141	2310
B3040FH	19.4	1819	1900	1962	2066	2185	2375	2565
B3340FH	21.2	1866	1951	2015	2124	2228	2416	2604
B3640FH	23.1	1929	2012	2076	2186	2305	2511	2717
B3940FH	24.9	1958	2048	2117	2226	2335	2538	2741

B4240FH	26.8	2021	2113	2180	2292	2416	2627	2838
B4540FH	28.7	2110	2204	2276	2394	2518	2738	2958
B4840FHCS	30.5	2192	2292	2367	2490	2605	2837	3069

B4840FH	30.5	2367	2475	2556	2689	2813	3064	3315
----------------	------	------	------	------	------	------	------	------

• Two sets of butt doors.

Notes below apply to all products in section above:

- Two full depth adjustable shelves.
- Reduced Depths available in 1/4" increments from 6" to 23 3/4".
- Increased Depths available in 1/4" increments from 24 1/4" to 30".

Door & Drawer Options

AF	AOMBWB	CC	CG	GAMD	IFHG	MD ¹	PRMD ¹	PTOWB	SHMD	SPLITDR	SPLITDRWS	TCP
		✓			✓	✓	✓					

End Panel Options

AUTH	CSFPE	EXBK	FFD	FL/FR	FPE	INTGE	IPE
✓	✓	✓	✓	✓	✓	✓	✓

Custom Modification Options

ADD_SHLF	ADDTK	CBO	CCO	CFNTO	CFP	CFRMO	CHGDRW	CLIP ²	CMAT	CND	CSDGBK	DRT	DRWSEC	DRWTK ³	EX	EX_OL	FBFL	FD	
		✓	✓	✓		✓		✓		✓	✓	✓	✓	✓	✓	✓	✓	✓	✓

FDSRTBTM ¹	FLUT ⁴	FTK ⁵	ID	IH	INVFRM	IW ⁶	LIGHT	MIP	OBRB	PFINBTMB	RD	RECTK	RECTK_6 ⁷	RECTKFR ⁶	RH	ROSFLUT ⁸	RT ¹	
✓	✓	✓	✓	✓	✓	✓	✓	✓	✓	✓	✓	✓	✓	✓	✓	✓	✓	✓

RW	SBCADDY ⁹	SBCADDYSM ¹	SCPRDW	SRT	STW	TD	TKP	TVR ¹⁰	UDBX	URT ¹¹	VTK	WS ¹²	WTCD	WTKCUP	WTR
	✓	✓	✓	✓	✓	✓	✓	✓	✓	✓	✓	✓	✓	✓	✓

¹ Not available on 9" wide.

² Not available on 9"-12" wide or 24" (2 doors) wide.

³ Not available on 9", 39"-48" wide.

⁴ 6" fluting only available on 24" (1 door) wide. Not available on 24" (2 doors) or 27" wide.

⁵ FTKAV and style B-L not available on 9"-12" wide.

⁶ Not available on 48" wide.

⁷ 9" and 12" wide can only be recessed in front and/or back. 15" and 18" wide can only be recessed in the front, back, and/or one side only.

⁸ Not available on 24" (2 doors) or 27" wide.

⁹ Not available on 9"-12" wide.

¹⁰ Not available on 9" wide or 42"-48" wide and TVRAV and style B-L not available on 9"-12".

¹¹ Only available on 24"-36" wide.

¹² Not available on 9" wide and WSB3 not available on 9"-12" wide.

Base Cabinets

FULL HEIGHT BASE with ROLL TRAYS, 34 1/2" HIGH, 24" DEEP

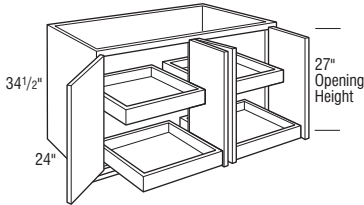
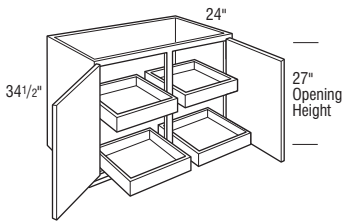
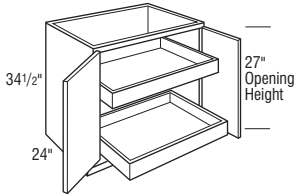
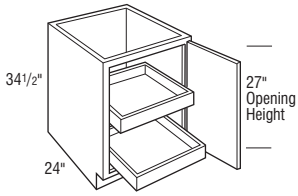

	Cubic Feet	1	2	3	4	5	6	7
B12FHRT L or R	7.5	1519	1569	1604	1661	1726	1835	1944
B15FHRT L or R	9.1	1573	1619	1656	1722	1776	1887	1998
B18FHRT L or R	10.8	1609	1667	1711	1772	1843	1963	2083
B21FHRT L or R	12.4	1663	1722	1760	1829	1887	2015	2143
B24FHRT L or R	14.1	1711	1766	1811	1877	1947	2076	2205

B24FHRT	14.1	2004	2078	2116	2201	2315	2481	2647
B27FHRT	15.7	2054	2128	2185	2274	2362	2531	2700
B30FHRT	17.4	2209	2290	2352	2456	2575	2765	2955
B33FHRT	19.0	2376	2461	2525	2634	2738	2926	3114
B36FHRT	20.7	2439	2522	2586	2696	2815	3021	3227
B39FHRT	22.4	2878	2968	3037	3146	3255	3458	3661

B42FHRT	24.0	2941	3033	3100	3212	3336	3547	3758
B45FHRT	25.7	3030	3124	3196	3314	3438	3658	3878
B48FHCSRT	27.3	3112	3212	3287	3410	3525	3757	3989

B48FHRT	27.3	3423	3533	3616	3751	3878	4133	4388
----------------	------	------	------	------	------	------	------	------

• Two sets of butt doors.

Notes below apply to all products in section above:

- Two roll trays standard.
- Cabinet may accommodate up to five roll trays, which may be purchased separately for field installation. See page S•9.
- Reduced Depths available in 1/4" increments from 12" to 23 3/4".

Door & Drawer Options

AF	AOMBWB	CC	CG	GAMD	IFHG	MD	PRMD	PTOWB	SHMD	SPLITDR	SPLITDRWS	TCP
	✓				✓	✓	✓					

End Panel Options

AUTH	CSFPE	EXBK	FFD	FL/FR	FPE	INTGE	IPE
✓	✓	✓	✓		✓	✓	✓

Custom Modification Options

ADD	SHLF	ADDTK	CBO	CCO	CFNTO	CFP	CFRMO	CHGDRW	CLIP ¹	CMAT	CND	CSDGBK	DRT	DRWSEC	DRWTK	EX	EX_OL	FBFL	FD
			✓	✓	✓		✓		✓		✓	✓		✓	✓	✓	✓	✓	✓

FDSRTBTM	FLUT ²	FTK ³	ID	IH	INVRM	IW ⁴	LIGHT	MIP	OBRB	PFINBTMB	RD	RECTK	RECTK	6 ⁵	RECTKFR6	RH	ROSFLUT ⁶	RT
	✓	✓			✓	✓	✓	✓	✓	✓	✓	✓	✓	✓	✓	✓	✓	✓

RW	SBCADDY	SBCADDYSM	SCPDRW	SRT	STW	TD	TKP	TVR ⁷	UDBX	URT ⁸	VTK	WS ⁹	WTCB	WTKCUP	WTR
								✓	✓	✓	✓	✓	✓	✓	✓

¹ Not available on 12" or 24" (2 doors) wide.

² 6" fluting only available on 24" wide. Not available on 24" (2 doors) or 27" wide.

³ FTKAV and style B-L not available on 12" wide.

⁴ Not available on 48" wide.

⁵ 12" wide can only be recessed in front and/or back. 15" and 18" wide can only be recessed in the front, back, and/or one side only.

⁶ Not available on 24" (2 doors) or 27" wide.

⁷ TVRAV and style B-L not available on 12". Not available on 39"-42" wide.

⁸ Only available on 24"-36" wide.

⁹ WSB3 not available on 12" wide.

IH/RH availability charts starting on page G•40.
IW/RW availability charts starting on page G•46.

FULL HEIGHT BASE with ROLL TRAYS, 40 1/2" HIGH, 24" DEEP

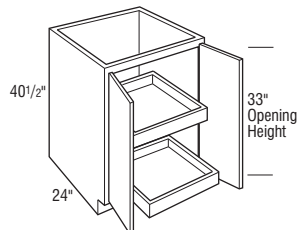
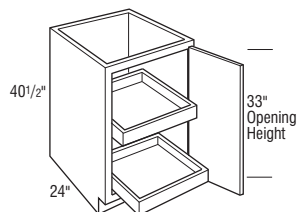

	Cubic Feet	1	2	3	4	5	6	7
B1540FHRT L or R	9.1	1935	1991	2037	2118	2184	2321	2458
B1840FHRT L or R	10.8	1979	2050	2105	2180	2267	2414	2561
B2140FHRT L or R	12.4	2045	2118	2165	2250	2321	2478	2635
B2440FHRT L or R	14.1	2070	2137	2191	2271	2356	2512	2668

B2440FHRT	14.1	2445	2535	2582	2685	2824	3027	3230
B2740FHRT	15.7	2485	2575	2644	2752	2858	3063	3268

Notes below apply to all products in section above:

- Two roll trays standard.
- Cabinet may accommodate up to five roll trays, which may be purchased separately for field installation. See page S99.
- Reduced Depths available in 1/4" increments from 12" to 23 3/4".

Door & Drawer Options

AF	AOMBWB	CC	CG	GAMD	IFHG	MD	PRMD	PTOWB	SHMD	SPLITDR	SPLITDRWS	TCP

End Panel Options

AUTH	CSFPE	EXBK	FFD	FL/FR	FPE	INTGE	IPE

Custom Modification Options

ADD_SHLF	ADDTK	CBO	CCO	CFNT0	CFP	CFRMO	CHGDRW	CLIP ¹	CMAT	CND	CSDGBK	DRT	DRWSEC	DRWTK	EX	EX_OL	FBFL	FD

FDSRTBTM	FLUT ²	FTK	ID	IH	INVFRM	IW	LIGHT	MIP	OBRB	PFINBTMB	RD	RECTK	RECTK_6 ³	RECTKFRT6	RH	ROSFLUT ⁴	RT

RW	SBCADDY	SBCADDYSM	SCPDRW	SRT	STW	TD	TKP	TVR	UDBX	URT ⁵	VTK	WS	WTC	WTKCUP	WTR

¹ Not available on 24" (2 doors) wide.

² 6" fluting only available on 24" (1 door) wide. Not available on 24" (2 doors) or 27" wide.

³ 15" and 18" wide can only be recessed in the front, back, and/or one side only.

⁴ Not available on 24" (2 doors) or 27" wide.

⁵ Only available on 24"-27" wide.

BASE EASY ACCESS STORAGE, 34 1/2" HIGH, 24" DEEP

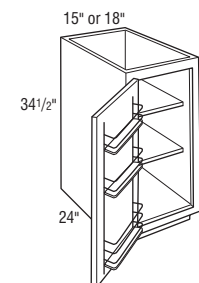

BEAS15 L or R	9.0	1365	1421	1465	1524	1586	1716	1846
BEAS18 L or R	10.0	1397	1447	1486	1551	1618	1747	1876

- Two adjustable 19 1/4" deep shelves.
- Door includes a three-tiered chrome rack with wood bottoms.
- Not available on Inset and Beaded Inset styles.

Door & Drawer Options

AF	AOMBWB	CC	CG	GAMD	IFHG	MD	PRMD	PTOWB	SHMD	SPLITDR	SPLITDRWS	TCP

End Panel Options

AUTH	CSFPE	EXBK	FFD	FL/FR	FPE	INTGE	IPE

Custom Modification Options

ADD_SHLF	ADDTK	CBO	CCO	CFNT0	CFP	CFRMO	CHGDRW	CLIP	CMAT	CND	CSDGBK	DRT	DRWSEC	DRWTK	EX	EX_OL	FBFL	FD

FDSRTBTM	FLUT ¹	FTK	ID	IH	INVFRM	IW	LIGHT	MIP	OBRB	PFINBTMB	RD	RECTK	RECTK_6 ²	RECTKFRT6	RH	ROSFLUT	RT

RW	SBCADDY	SBCADDYSM	SCPDRW	SRT	STW	TD	TKP	TVR	UDBX	URT	VTK	WS	WTC	WTKCUP	WTR

¹ Not available with 6" fluting.

² Can only be recessed in the front, back, and/or one side only.

Base Cabinets

BASE with TWO SPLIT DRAWERS, 34 1/2" HIGH, 24" DEEP

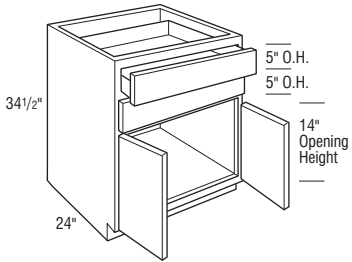
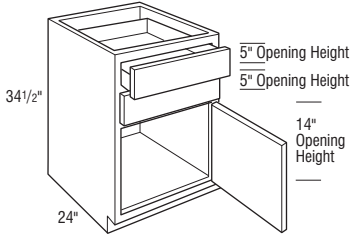

	Cubic Feet	1	2	3	4	5	6	7
B2D9 L or R	5.8	1278	1341	1389	1464	1549	1690	1831
B2D12 L or R	7.5	1329	1393	1441	1520	1610	1757	1904
B2D15 L or R	9.1	1448	1519	1570	1656	1754	1918	2082
B2D18 L or R	10.8	1576	1653	1711	1805	1913	2086	2259
B2D21 L or R	12.4	1671	1751	1811	1913	2021	2211	2401
B2D24 L or R	14.1	1776	1860	1925	2031	2152	2350	2548
B2D24	14.1	2126	2227	2309	2431	2576	2815	3054
B2D27	15.7	2240	2348	2430	2564	2716	2966	3216
B2D30	17.4	2476	2596	2688	2833	2999	3277	3555
B2D33	19.0	2537	2660	2753	2903	3077	3358	3639
B2D36	20.7	2591	2716	2810	2963	3139	3428	3717

Notes below apply to all products in section above:

- No shelving in door section.
- Reduced Depths available in 1/4" increments from 12" to 23 3/4".

Door & Drawer Options

AF	AOMBWB	CC	CG	GAMD ¹	IFHG	MD ¹	PRMD ²	PTOWB	SHMD ¹	SPLITDR ³	SPLITDRWS	TCP
	✓	✓	✓	✓	✓	✓	✓	✓	✓	✓	✓	✓

End Panel Options

AUTH	CSFPE	EXBK	FFD	FL/FR	FPE	INTGE	IPE
✓	✓	✓	✓	✓	✓	✓	✓

Custom Modification Options

ADD	SHLF	ADDTK	CBO	CCO	CFNTO	CFP	CFRMO	CHGDRW ⁴	CLIP ⁵	CMAT	CND	CSDGBK	DRT	DRWSEC ⁶	DRWTK ⁷	EX	EX_OL	FBFL	FD
	✓	✓	✓	✓	✓	✓	✓	✓	✓	✓	✓	✓	✓	✓	✓	✓	✓	✓	✓

FDSRTBTM	FLUT ⁸	FTK ⁹	ID	IH	INVFRM	IW ¹⁰	LIGHT	MIP	OBRB	PFINBTMB	RD	RECTK	RECTK_6 ¹¹	RECTKFR6	RH	ROSEFLUT	RT
	✓	✓	✓	✓	✓	✓	✓	✓	✓	✓	✓	✓	✓	✓	✓	✓	✓

RW	SBCADDY	SBCADDYSM	SCPRDW	SRT	STW	TD	TKP	TVR	UBX ¹²	URT	VTK	WS ¹³	WTC ¹⁴	WTKCUP ⁴	WTR
		✓	✓	✓	✓	✓	✓	✓	✓	✓	✓	✓	✓	✓	✓

¹ Not available on 9" wide.

² Not available on 9", 12" or 24" (2 doors) wide.

³ Not available on 9" x 24" (1 door) wide.

⁴ Only available on 18" wide.

⁵ Not available on 9", 12" or 24" (2 doors) wide.

⁶ Only available on 18" x 24" wide.

⁷ Only available on 24" (1 door and 2 doors), 30" and 36" wide.

⁸ 6" fluting not available on 9", 12", 15", or 24" (2 doors) wide. Fluting both 6" not available on 18" or 21" wide.

⁹ FTKAV and style B-L not available on 9" or 12" wide.

¹⁰ Not available on 24" (1 door) wide.

¹¹ 9" and 12" wide can only be recessed in front and/or back. 15", 18", and 21" wide can only be recessed in the front, back, and/or one side only.

¹² Not available on 9" x 21" wide.

¹³ Not available on 9" wide and wide stile both 3" not available on 12" wide.

¹⁴ Only available on 15", 18", 21", 24", 30", and 36" wide.

IH/RH availability charts starting on page G-40.
IW/RW availability charts starting on page G-46.

BASE with TWO SPLIT DRAWERS and ROLL TRAY, 34 1/2" HIGH, 24" DEEP

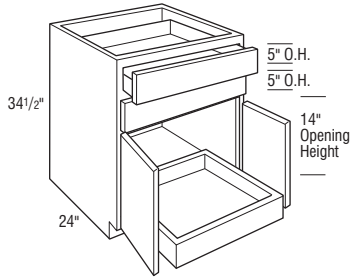
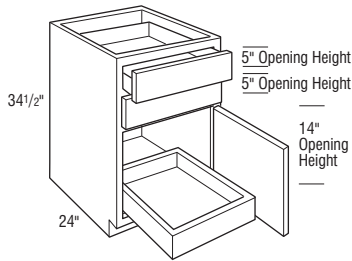

Cubic Feet	1	2	3	4	5	6	7
B2D12RT L or R	7.5	1914	2005	2075	2187	2319	2741
B2D15RT L or R	9.1	1983	2078	2152	2270	2404	2840
B2D18RT L or R	10.8	2011	2107	2182	2300	2436	2884
B2D21RT L or R	12.4	2078	2179	2255	2377	2517	2985
B2D24RT L or R	14.1	2111	2214	2291	2416	2559	3031

B2D24RT	14.1	2479	2599	2690	2837	3004	3285	3566
B2D27RT	15.7	2747	2881	2979	3142	3328	3635	3942
B2D30RT	17.4	2792	2930	3031	3196	3385	3697	4009
B2D33RT	19.0	2843	2979	3084	3251	3444	3762	4080
B2D36RT	20.7	2893	3032	3138	3310	3506	3830	4154

Notes below apply to all products in section above:

- No shelving in door section.
- Contains one easily adjustable roll tray.
- Reduced Depths available in 1/4" increments from 12 1/4" to 23 3/4".

Door & Drawer Options

AF	AOMBWB	CC	CG	GAMD	IFHG	MD	PRMD ¹	PTOWB	SHMD	SPLITDR ²	SPLITDRWS	TCP

End Panel Options

AUTH	CSFPE	EXBK	FFD	FL/FR	FPE	INTGE	IPE

Custom Modification Options

ADD	SHLF	ADDTK	CBO	CCO	CFNT0	CFP	CFRMO	CHGDRW ³	CLIP ⁴	CMAT	CND	CSDGBK	DRT	DRWSEC ⁵	DRWTK ⁶	EX	EX_OL	FBFL	FD	

FDSRTBTM	FLUT ⁷	FTK ⁸	ID	IH	INVFRM	IW ⁹	LIGHT	MIP	OBRB	PFINBTMB	RD	RECTK	RECTK_6 ¹⁰	RECTKFR6	RH	ROSLUT	RT

RW	SBCADDY	SBCADDYSM	SCPDRW	SRT	STW	TD	TKP	TVR	UDBX ¹¹	URT ¹¹	VTK	WS ¹²	WTC ¹³	WTKCUP ³	WTR

¹ Not available on 12" or 24" (2 doors) wide.

² Not available on 12"-24" (1 door and 2 doors) wide.

³ Only available on 18" wide.

⁴ Not available on 12" or 24" (2 doors) wide.

⁵ Only available on 18"-24" wide.

⁶ Not available on 12"-21", 27" or 33" wide.

⁷ 6" fluting not available on 12", 15" or 24" (2 doors) wide. Fluting both 6" not available on 18" or 21" wide.

⁸ FTKAV and style B-L not available on 12" wide.

⁹ Not available on 24" (1 door) wide.

¹⁰ 12" wide can only be recessed in front and/or back. 15" and 18" wide can only be recessed in the front, back, and/or one side only.

¹¹ Not available on 12"-21" wide.

¹² Not available on 12" wide and wide stile both 1.5" not available on 15" wide.

¹³ Only available on 15", 18", 21", 24", 30", and 36" wide.

Base Cabinets

BASE DOUBLE DOOR with FOUR SPLIT DRAWERS, 34 1/2" HIGH, 24" DEEP

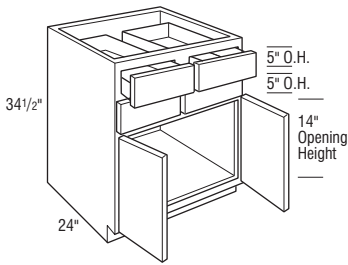

	Cubic Feet	1	2	3	4	5	6	7
B4D24	14.1	2646	2770	2869	3029	3207	3501	3795
B4D27	15.7	2761	2895	2995	3158	3346	3654	3962
B4D30	17.4	2995	3139	3251	3427	3633	3967	4301
B4D33	19.0	3057	3205	3319	3497	3704	4046	4388
B4D36	20.7	3112	3260	3377	3560	3770	4117	4464
B4D39	22.4	3189	3346	3464	3652	3869	4226	4583

- No shelving in door section.
- Reduced Depths available in 1/4" increments from 12" to 23 3/4".
- Exceptions may apply when using IW with Clipped Corners or Wide Stiles. Please reference these sections in Section G for more details.

Door & Drawer Options

AF	AOMBWB	CC	CG	GAMD	IFHG	MD	PRMD ¹	PTOWB	SHMD	SPLITDR ¹	SPLITDRWS	TCP

End Panel Options

AUTH	CSFPE	EXBK	FFD	FL/FR	FPE	INTGE	IPE

Custom Modification Options

ADD_SHLF	ADDTK	CBO	CCO	CFNTD	CFP	CFRMO	CHGDRW ²	CLIP ³	CMAT	CND	CSDGBK	DRT	DRWSEC ²	DRWTK ⁴	EX	EX_OL	FBFL	FD

FDSRTBTM	FLUT ⁵	FTK	ID	IH	INFRM	IW	LIGHT	MIP	OBRB	PFINBTMB	RD	RECTK	RECTK_6	RECTKFR6	RH	ROSFLUT	RT

RW	SBCADDY	SBCADDYSM	SCPDWR	SRT	STW	TD	TKP	TVR	UDBX	URT	VTK	WS	WTCO ⁶	WTKCUP ²	WTR

- ¹ Not available on 24" wide.
² Only available on 36" wide.
³ Not available on 24" wide.
⁴ Not available on 27" or 33" wide.
⁵ 6" fluting not available on 24" or 27" wide and not available with fluting both 6".
⁶ Not available on 24", 27" or 33" wide.

BASE DOUBLE DOOR with FOUR SPLIT DRAWERS and ROLL TRAY, 34 1/2" HIGH, 24" DEEP

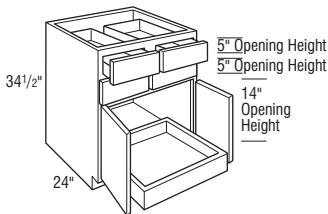

	Cubic Feet	1	2	3	4	5	6	7
B4D24RT	14.1	3337	3500	3625	3821	4046	4421	4796
B4D27RT	15.7	3452	3622	3750	3953	4188	4574	4960
B4D30RT	17.4	3691	3868	4005	4222	4474	4885	5296
B4D33RT	19.0	3751	3930	4072	4291	4545	4965	5385
B4D36RT	20.7	3804	3987	4127	4352	4609	5035	5461

- No shelving in door section.
- Contains one easily adjustable roll tray.
- Reduced Depths available in 1/4" increments from 12" to 23 3/4".
- Exceptions may apply when using IW with Clipped Corners or Wide Stiles. Please reference these sections in Section G for more details.

Door & Drawer Options

AF	AOMBWB	CC	CG	GAMD	IFHG	MD	PRMD ¹	PTOWB	SHMD	SPLITDR ¹	SPLITDRWS	TCP

End Panel Options

AUTH	CSFPE	EXBK	FFD	FL/FR	FPE	INTGE	IPE

Custom Modification Options

ADD_SHLF	ADDTK	CBO	CCO	CFNTD	CFP	CFRMO	CHGDRW ²	CLIP ³	CMAT	CND	CSDGBK	DRT	DRWSEC ²	DRWTK ⁴	EX	EX_OL	FBFL	FD

FDSRTBTM	FLUT ⁵	FTK	ID	IH	INFRM	IW	LIGHT	MIP	OBRB	PFINBTMB	RD	RECTK	RECTK_6	RECTKFR6	RH	ROSFLUT	RT

RW	SBCADDY	SBCADDYSM	SCPDWR	SRT	STW	TD	TKP	TVR	UDBX	URT	VTK	WS	WTCO ⁶	WTKCUP ²	WTR

- ¹ Not available on 24" wide.
² Only available with 36" wide.
³ Not available on 24" wide.
⁴ Not available on 27" or 33" wide.
⁵ 6" fluting not available on 24" or 27" wide and not available with fluting both 6".
⁶ Not available on 24", 27" or 33" wide.

IH/RH availability charts starting on page G-40.
 IW/RW availability charts starting on page G-46.

BASE DOUBLE DOOR with FOUR SPLIT DRAWERS, 34 1/2" HIGH, 24" DEEP

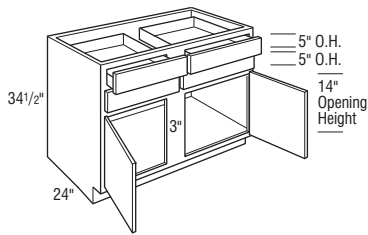

	Cubic Feet	1	2	3	4	5	6	7
B4D42	24.0	3892	4079	4224	4454	4718	5153	5588
B4D45	25.7	3997	4192	4340	4575	4844	5295	5746
B4D48	27.3	4084	4282	4434	4675	4950	5408	5866

- No shelving in door section.
- Reduced Depths available in 1/4" increments from 12" to 23 3/4".
- Exceptions may apply when using IW with Clipped Corners or Wide Stiles. Please reference these sections in Section G for more details.

Door & Drawer Options

AF	AOMBWB	CC	CG	GAMD	IFHG	MD	PRMD	PTOWB	SHMD	SPLITDR	SPLITDRWS	TCP

End Panel Options

AUTH	CSFPE	EXBK	FFD	FL/FR	FPE	INTGE	IPE

Custom Modification Options

ADD	SHLF	ADDTK	CBO	CCO	CFNTD	CFP	CFRMO	CHGDRW	CLIP	CMAT	CND	CSDGBK	DRT	DRWSEC ¹	DRWTK	EX	EX_OL	FBFL	FD

FDSRTBTM	FLUT	FTK	ID	IH	INVFRM	IW ²	LIGHT	MIP	OBRB	PFINBTMB	RD	RECTK	RECTK_6	RECTKFRT6	RH	ROSLUT	RT

RW	SBCADDY	SBCADDYSM	SCPDRW	SRT	STW	TD	TKP	TVR	UDBX ³	URT	VTK	WS	WTC ¹	WTKCUP	WTR

¹ Not available on 45" wide.

² Not available on 48" wide.

³ Only available on 48" wide.

BASE DOUBLE DOOR with FOUR SPLIT DRAWERS and ROLL TRAYS, 34 1/2" HIGH, 24" DEEP

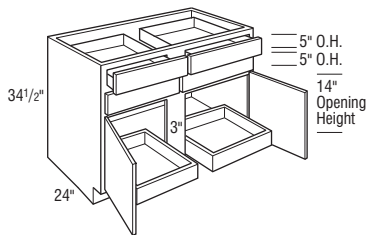

B4D39RT	22.4	4490	4703	4871	5136	5441	5943	6445
B4D42RT	24.0	4584	4806	4977	5244	5558	6070	6582
B4D45RT	25.7	4691	4918	5093	5367	5687	6210	6733
B4D48RT	27.3	4778	5009	5186	5468	5793	6326	6859

- No shelving in door section.
- Contains two easily adjustable roll trays.
- Reduced Depths available in 1/4" increments from 12" to 23 3/4".
- Exceptions may apply when using IW with Clipped Corners or Wide Stiles. Please reference these sections in Section G for more details.

Door & Drawer Options

AF	AOMBWB	CC	CG	GAMD	IFHG	MD	PRMD	PTOWB	SHMD	SPLITDR	SPLITDRWS	TCP

End Panel Options

AUTH	CSFPE	EXBK	FFD	FL/FR	FPE	INTGE	IPE

Custom Modification Options

ADD	SHLF	ADDTK	CBO	CCO	CFNTD	CFP	CFRMO	CHGDRW	CLIP	CMAT	CND	CSDGBK	DRT	DRWSEC ¹	DRWTK	EX	EX_OL	FBFL	FD

FDSRTBTM	FLUT ²	FTK	ID	IH	INVFRM	IW ³	LIGHT	MIP	OBRB	PFINBTMB	RD	RECTK	RECTK_6	RECTKFRT6	RH	ROSLUT	RT

RW	SBCADDY	SBCADDYSM	SCPDRW	SRT	STW	TD	TKP	TVR	UDBX ⁴	URT ⁴	VTK	WS	WTC ⁵	WTKCUP	WTR

¹ Only available on 42" and 48" wide.

² Not available with fluting both 6".

³ Not available on 48" wide.

⁴ Only available on 48" wide.

⁵ Not available on 39" or 45" wide.

Base Cabinets & Base SuperCabinets™

BASE BUFFET with ROLL TRAYS, 34 1/2" HIGH, 24" DEEP

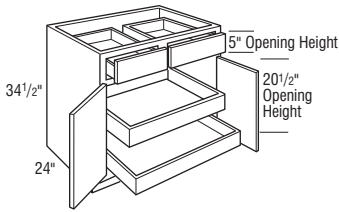

	Cubic Feet	1	2	3	4	5	6	7
B30RTB	17.4	2506	2587	2649	2756	2854	3050	3246
B33RTB	19.0	2549	2635	2708	2812	2913	3111	3309
B36RTB	20.7	2596	2685	2756	2864	2972	3176	3380

- Two roll trays standard.
- Reveal between drawers will not align with doors below.
- Cabinet may accommodate up to four roll trays, which may be purchased separately for field installation. See page S•9.

Door & Drawer Options

AF	AOMBWB	CC	CG	GAMD	IFHG	MD	PRMD	PTOWB	SHMD	SPLITDR	SPLITDRWS	TCP
			✓		✓	✓	✓					

End Panel Options

AUTH	CSFPE	EXBK	FFD	FL/FR	FPE	INTGE	IPE
✓	✓	✓			✓	✓	✓

Custom Modification Options

ADD	SHLF	ADDTK	CBO	CCO	CFNTO	CFP	CFRMO	CHGDRW ¹	CLIP	CMAT	CND	CSDGBK	DRT	DRWSEC	DRWTK	EX ¹	EX_OL ¹	FBFL	FD
								✓	✓			✓	✓	✓	✓	✓	✓	✓	✓

FDSRTBTM	FLUT	FTK	ID	IH	INFRM	IW	LIGHT	MIP	OBRB	PFINBTMB	RD	RECTK	RECTK_6	RECTKFT6	RH	ROSLUT	RT
	✓	✓	✓	✓	✓	✓	✓	✓	✓	✓	✓	✓	✓	✓	✓	✓	✓

RW	SBCADDY	SBCADDYSM	SCPDWR	SRT	STW	TD	TKP	TVR	UBX	URT	VTK	WS	WTCO ²	WTKCUP ¹	WTR
				✓				✓	✓	✓	✓	✓	✓	✓	✓

¹ Only available on 36" wide.

² Not available on 33" wide.

30" SUPERCABINET™, 34 1/2" HIGH, 24" DEEP

L O G I X

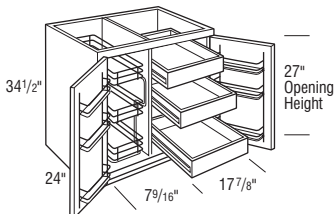

Right Shown

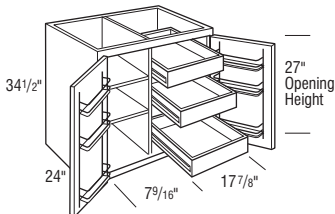

Right Shown

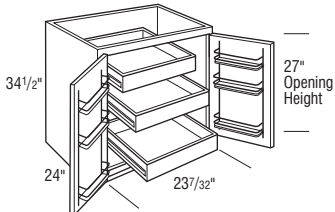

BSC30R

BSC30RP	17.4	2989	3067	3128	3234	3352	3540	3728
BSC30PR	17.4	2989	3067	3128	3234	3352	3540	3728

BSC30RS	17.4	2412	2487	2554	2657	2774	2963	3152
BSC30SR	17.4	2412	2487	2554	2657	2774	2963	3152

BSC30R	17.4	2341	2425	2485	2593	2709	2901	3093
---------------	------	------	------	------	------	------	------	------

Notes below apply to all products in section above:

- Cabinets with full overlay style utilize 170° hinge. For sufficient pull-out clearance, 12" of adjacent space is required for door to open 170° when installed near a wall or corner.
- Shelves are adjustable and 20" deep.
- Roll trays are Full Extension side-mounted.
- Pull-out side door has to open 170°.
- Smart Stop feature not available.
- Door includes a three-tiered chrome rack with wood bottoms.
- Not available on Inset and Beaded Inset styles.

Door & Drawer Options

AF	AOMBWB	CC	CG	GAMD	IFHG	MD	PRMD	PTOWB	SHMD	SPLITDR	SPLITDRWS	TCP

End Panel Options

AUTH	CSFPE	EXBK	FFD	FL/FR	FPE	INTGE	IPE
✓	✓	✓			✓	✓	✓

Custom Modification Options

ADD	SHLF	ADDTK	CBO	CCO	CFNTO	CFP	CFRMO	CHGDRW	CLIP	CMAT	CND	CSDGBK	DRT	DRWSEC	DRWTK	EX ¹	EX_OL ¹	FBFL	FD
																✓	✓	✓	

FDSRTBTM	FLUT ²	FTK	ID	IH	INFRM	IW	LIGHT	MIP	OBRB	PFINBTMB	RD	RECTK	RECTK_6	RECTKFT6	RH	ROSLUT	RT
	✓	✓	✓	✓	✓	✓	✓	✓	✓	✓	✓	✓	✓	✓	✓	✓	✓

RW	SBCADDY	SBCADDYSM	SCPDWR	SRT	STW	TD	TKP	TVR	UBX	URT	VTK	WS	WTCO	WTKCUP	WTR
								✓	✓	✓	✓	✓	✓	✓	✓

¹ Not available on BSC30SR.

² Not available with 6" fluting.

IH/RH availability charts starting on page G•40.
IW/RW availability charts starting on page G•46.

36" SUPERCABINET™, 34 1/2" HIGH, 24" DEEP

L O G I X

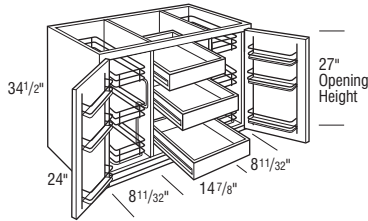

BSC36PRP

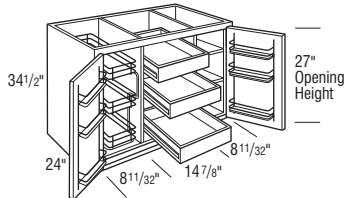

BSC36PRS

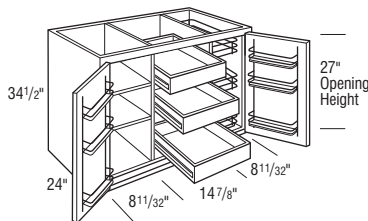

BSC36SRP

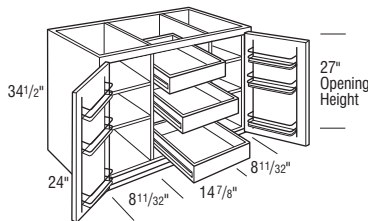

BSC36SRS

	Cubic Feet	1	2	3	4	5	6	7
BSC36PRP	20.7	3820	3902	3966	4076	4196	4400	4604
BSC36PRS	20.7	3289	3374	3435	3547	3663	3870	4077
BSC36SRP	20.7	3289	3374	3435	3547	3663	3870	4077
BSC36SRS	20.7	2710	2794	2856	2966	3087	3289	3491

Notes below apply to all products in section above:

- Cabinets with full overlay style utilize 170° hinge. For sufficient pull-out clearance, 12" of adjacent space is required for door to open 170° when installed near a wall or corner.
- Shelves are adjustable and 20" deep.
- Roll trays are Full Extension side-mounted.
- Pull-out side door has to open 170°.
- Smart Stop feature not available.
- Door includes a three-tiered chrome rack with wood bottoms.
- Not available on Inset and Beaded Inset styles.

Door & Drawer Options

AF	AOMBWB	CC	CG	GAMD	IFHG	MD	PRMD	PTOWB	SHMD	SPLITDR	SPLITDRWS	TCP
----	--------	----	----	------	------	----	------	-------	------	---------	-----------	-----

End Panel Options

AUTH	CSFPE	EXBK	FFD	FL/FR	FPE	INTGE	IPE
✓	✓	✓	✓	✓	✓	✓	✓

Custom Modification Options

ADD_SHLF	ADDTK	CBO	CCO	CFNTO	CFP	CFRMO	CHGDRW	CLIP	CMAT	CND	CSDGBK	DRT	DRWSEC	DRWTK	EX	EX_OL	FBFL	FD
														✓	✓	✓		

FDSRTBTM	FLUT ¹	FTK	ID	IH	INVFRM	IW	LIGHT	MIP	OBRB	PFINBTMB	RD	RECTK	RECTK_6	RECTKFRT6	RH	ROSLUT	RT
	✓	✓							✓		✓	✓				✓	

RW	SBCADDY	SBCADDYSM	SCPDRW	SRT	STW	TD	TKP	TVR	UDBX	URT	VTK	WS	WTCD	WTKCUP	WTR
								✓			✓				✓

¹ Not available with 6" fluting.

Base SuperCabinets™

BASE SUPERCABINET™ GOURMET, 34 1/2" HIGH, 24" DEEP

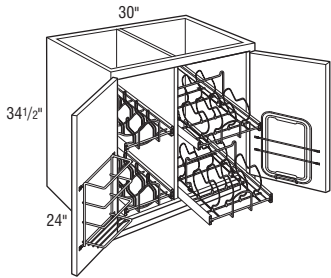

BSCG30 L or R

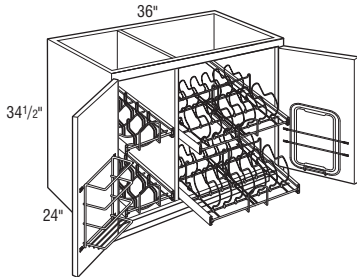

BSCG36 L or R

Cubic Feet	1	2	3	4	5	6	7	
BSCG30 L or R	17.2	3457	3585	3711	3841	3905	3970	4035
BSCG36 L or R	20.5	3784	3912	4041	4169	4233	4297	4361

- Pots and Pans pull-out includes 8 dividers per tray for adjustable storage.

- Pots and Pans pull-out includes 16 dividers per tray for adjustable storage.

Notes below apply to all products in section above:

- L or R designates lid holder side.
- Cabinets with full overlay style utilize 170° hinge. For sufficient pull-out clearance, 12" of adjacent space is required for door to open 170° when installed near a wall or corner.
- Left door features wrap/foil rack.
- Right door features cutting board and cutting board storage rack.
- Lid pull-out will hold 6 lids per tray. Maximum lid diameter is 8 1/2" on bottom tray and 9 3/4" on top tray.
- Not available on Inset and Beaded Inset.
- Smart Stop feature not available.

Door & Drawer Options

AF	AOMBWB	CC	CG	GAMD	IFHG	MD	PRMD	PTOWB	SHMD	SPLITDR	SPLITDRWS	TCP
----	--------	----	----	------	------	----	------	-------	------	---------	-----------	-----

End Panel Options

AUTH	CSFPE	EXBK	FFD	FL/FR	FPE	INTGE	IPE
✓	✓	✓		✓	✓		

Custom Modification Options

ADD	SHLF	ADDTK	CBO	CCO	CFNTO	CFP	CFRMO	CHGDRW	CLIP	CMAT	CND	CSDGBK	DRT	DRWSEC	DRWTK	EX	EX_OL	FBFL	FD
-----	------	-------	-----	-----	-------	-----	-------	--------	------	------	-----	--------	-----	--------	-------	----	-------	------	----

FDSRTBTM	FLUT ¹	FTK	ID	IH	INVERM	IW	LIGHT	MIP	OBRB	PFINBTMB	RD	RECTK	RECTK_6	RECTKFRT6	RH	ROSLUT	RT
	✓	✓						✓								✓	

RW	SBCADDY	SBCADDYSM	SCPDW	SRT	STW	TD	TKP	TVR	UDBX	URT	VTK	WS	WTCD	WTKCUP	WTR
												✓			✓

¹ Not available with 6" fluting.

IH/RH availability charts starting on page G•40.
IW/RW availability charts starting on page G•46.

WALL BASE, 34 1/2" HIGH, 12" DEEP

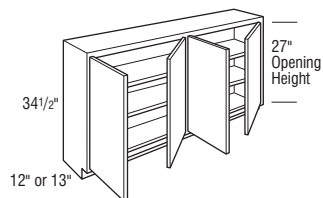
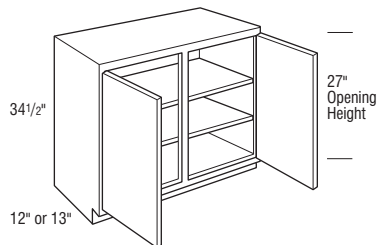
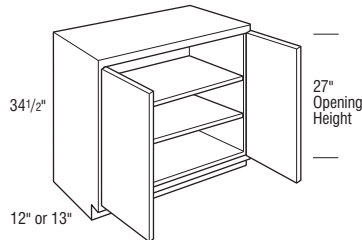
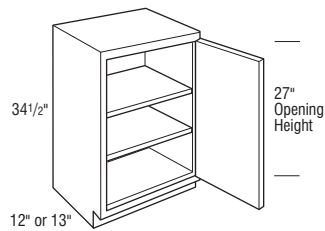

Cubic Feet	1	2	3	4	5	6	7	
WB12 L or R	4.1	876	918	953	1003	1083	1171	1259
WB15 L or R	5.0	953	999	1031	1089	1147	1255	1363
WB18 L or R	5.9	999	1046	1080	1140	1207	1321	1435
WB21 L or R	6.8	1027	1078	1118	1187	1236	1346	1456
WB24 L or R	7.7	1073	1119	1161	1226	1292	1410	1528

WB24	7.7	1343	1409	1457	1535	1631	1780	1929
WB27	8.6	1524	1598	1655	1744	1832	2001	2170
WB30	9.5	1592	1666	1731	1823	1915	2091	2267
WB33	10.4	1650	1726	1789	1887	1976	2156	2336
WB36	11.3	1715	1796	1864	1970	2062	2257	2452
WB39	12.2	1796	1882	1946	2052	2170	2373	2576

WB42	13.1	1848	1936	2004	2116	2225	2438	2651
WB45	14.0	1951	2049	2126	2239	2350	2574	2798
WB48CS	15.0	2052	2152	2227	2350	2465	2697	2929

WB48	15.0	2257	2367	2450	2585	2712	2967	3222
-------------	------	------	------	------	------	------	------	------

• Two sets of butt doors.

Notes below apply to all products in section above:

- Two full depth adjustable shelves.
- Unit is constructed with toekick and full wall-type top.
- Price all options using base cabinet option prices.
- Inset and Beaded Inset Door Styles are a standard 13" deep.
- Full Overlay Styles:
 - Increased Depths available in 1/4" increments from 12 1/4" to 30".
 - Reduced Depths available in 1/4" increments from 6" to 11 3/4".
- Inset and Beaded Inset Styles:
 - Increased Depths available in 1/4" increments from 13 1/4" to 30".
 - Reduced Depths available in 1/4" increments from 6" to 12 3/4".

Door & Drawer Options

AF	AOMBWB	CC	CG	GAMD	IFHG	MD	PRMD ¹	PTOWB	SHMD	SPLITDR ²	SPLITDRWS	TCP
✓		✓	✓	✓	✓	✓	✓		✓	✓		

End Panel Options

AUTH	CSFPE	EXBK	FFD	FL/FR	FPE	INTGE	IPE
✓	✓	✓	✓	✓	✓	✓	✓

Custom Modification Options

ADD_SHLF	ADDTK	CBO	CCO	CFNT0	CFP	CFRMO	CHGDRW	CLIP ³	CMAT	CND	CSDGBK	DRT	DRWSEC	DRWTK	EX	EX_OL	FBFL	FD

FDSRTBTM ⁴	FLUT ⁵	FTK ⁶	ID	IH	INVFRM	IW	LIGHT	MIP	OBRB	PFINBTMB	RD	RECTK	RECTK_6	RECTKERT6	RH	ROSLUT	RT
✓	✓	✓	✓	✓				✓	✓		✓				✓	✓	✓

RW	SBCADDY	SBCADDYSM	SCPDRW	SRT	STW	TD	TKP	TVR ⁷	UDBX	URT	VTK	WS	WTCD	WTKCUP	WTR
								✓	✓			✓			✓

¹ Not available on 12" or 24" (2 doors) wide.

² Only available on 24" (2 doors)-39" wide.

³ Not available on 24" (2 doors).

⁴ Only available on 12" wide.

⁵ Not available with 6" fluting.

⁶ FTKAV and style B-L not available on 12" wide.

⁷ Not available on 42"-48" wide.

Drawer Base Cabinets

FOUR DRAWER BASE, 34 1/2" HIGH, 24" DEEP

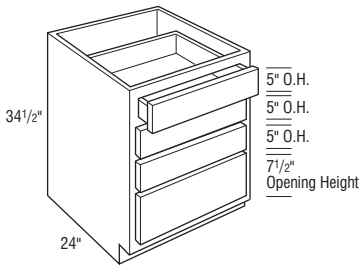

	Cubic Feet	1	2	3	4	5	6	7
4DB12	7.5	1385	1453	1485	1568	1769	1935	2101
4DB15	9.1	1517	1586	1632	1725	1945	2126	2307
4DB18	10.8	1624	1704	1746	1846	2088	2276	2464
4DB21	12.4	1737	1819	1872	1981	2235	2439	2643
4DB24	14.1	1864	1954	2005	2118	2396	2615	2834
4DB27	15.7	2132	2239	2300	2422	2736	2992	3248
4DB30	17.4	2599	2726	2797	2952	3326	3640	3954
4DB33	19.0	2661	2794	2865	3029	3414	3730	4046
4DB36	20.7	2724	2858	2938	3099	3496	3825	4154
4DB39	22.4	2901	3041	3130	3304	3727	4077	4427
4DB42	24.0	2904	3047	3139	3318	3742	4093	4444

• Reduced Depths available in 1/4" increments from 12" to 23 3/4".

Door & Drawer Options

AF	AOMBWB	CC	CG	GAMD	IFHG	MD	PRMD	PTOWB	SHMD	SPLITDR	SPLITDRWS ¹	TCP

End Panel Options

AUTH	CSFPE	EXBK	FFD	FL/FR	FPE	INTGE	IPE

Custom Modification Options

ADD	SHLF	ADDTK	CBO	CCO	CFNTO	CFP	CFRMO	CHGDRW ²	CLIP ³	CMAT	CND	CSDGBK	DRT	DRWSEC ⁴	DRWTK ⁵	EX	EX_OL	FBFL	FD
FDSRTBTM	FLUT ⁶	FTK ⁷	ID	IH	INVFRM	IW ⁸	LIGHT	MIP	OBRB	PFINBTMB	RD	RECTK	RECTK_6 ⁹	RECTKFR6	RH	ROSFLUT	RT		
RW	SBCADDY	SBCADDYSM	SCPDWR	SRT	STW	TD	TKP	TVR	UDBX ¹	URT	VTK	WS ¹⁰	WTCO ¹¹	WTKCUP ¹²	WTR				

¹ Not available on 12"-21" wide.

² Only available with 36" wide. 36" wide only available in conjunction with SPLITDRWS modification.

³ Not available on 12" wide.

⁴ Only available on 18"-24" wide.

⁵ Only available on 24", 30" and 36" wide.

⁶ 6" fluting not available on 12"-15" wide and fluting both 6" not available on 18" or 21" wide.

⁷ FTKAV and style B-L not available on 12" wide.

⁸ Not available on 42" wide.

⁹ 12" wide can only be recessed in front and/or back. 15" and 18" wide can only be recessed in the front, back, and/or one side only.

¹⁰ Not available on 12" wide.

¹¹ Only available on 30" and 36" wide.

¹² Only available on 36" wide.

SIX DRAWER BASE, 34 1/2" HIGH, 24" DEEP

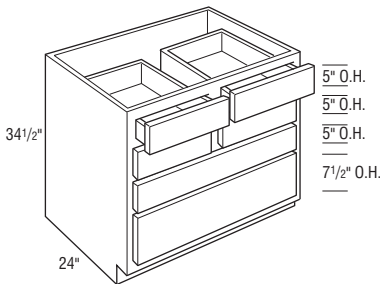

6DB30	17.4	2989	3134	3222	3393	3827	4189	4551
6DB33	19.0	3058	3213	3296	3480	3923	4292	4661
6DB36	20.7	3131	3288	3379	3564	4023	4397	4771
6DB42	24.0	3337	3501	3611	3816	4304	4708	5112

• Reduced Depths available in 1/4" increments from 12" to 23 3/4".

Door & Drawer Options

AF	AOMBWB	CC	CG	GAMD	IFHG	MD	PRMD	PTOWB	SHMD	SPLITDR	SPLITDRWS	TCP

End Panel Options

AUTH	CSFPE	EXBK	FFD	FL/FR	FPE	INTGE	IPE

Custom Modification Options

ADD	SHLF	ADDTK	CBO	CCO	CFNTO	CFP	CFRMO	CHGDRW ¹	CLIP	CMAT	CND	CSDGBK	DRT	DRWSEC ²	DRWTK ³	EX	EX_OL	FBFL	FD
FDSRTBTM	FLUT ⁴	FTK	ID	IH	INVFRM	IW	LIGHT	MIP	OBRB	PFINBTMB	RD	RECTK	RECTK_6	RECTKFR6	RH	ROSFLUT	RT		
RW	SBCADDY	SBCADDYSM	SCPDWR	SRT	STW	TD	TKP	TVR ⁵	UDBX	URT	VTK	WS	WTCO	WTKCUP ¹	WTR				

¹ Only available on 36" wide.

² Only available on 36"-42" wide.

³ Not available on 33" or 42" wide.

⁴ Fluting both 6" not available on 30" or 33" wide.

⁵ Not available on 30" or 36" wide.

IH/RH availability charts starting on page G•40.
IW/RW availability charts starting on page G•46.

FOUR DRAWER BASE with BREAD BOARD, 34 1/2" HIGH, 24" DEEP

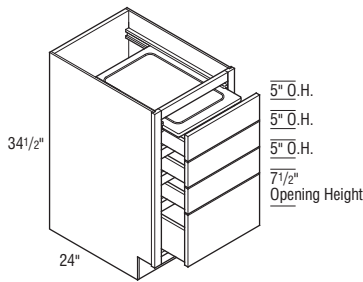

	Cubic Feet	1	2	3	4	5	6	7
4DB12BB	7.5	1897	1989	2062	2175	2303	2514	2725
4DB15BB	9.1	2075	2177	2254	2374	2516	2749	2982
4DB18BB	10.8	2270	2378	2462	2594	2749	3002	3255
4DB21BB	12.4	2420	2537	2626	2768	2934	3205	3476
4DB24BB	14.1	2612	2736	2834	2989	3166	3457	3748

Door & Drawer Options

AF	AOMBWB	CC	CG	GAMD	IFHG	MD	PRMD	PTOWB	SHMD	SPLITDR	SPLITDRWS	TCP

End Panel Options

AUTH	CSFPE	EXBK	FFD	FL/FR	FPE	INTGE	IPE
✓	✓	✓	✓	✓	✓	✓	✓

Custom Modification Options

ADD_SHLF	ADDTK	CBO	CCO	CFNTD	CFP	CFRMO	CHGDRW	CLIP ¹	CMAT	CND	CSDGBK	DRT	DRWSEC	DRWTK ²	EX	EX_OL	FBFL	FD

FDSRTBTM	FLUT ³	FTK ⁴	ID	IH	INVFRM	IW	LIGHT	MIP	OBRB	PFINBTMB	RD	RECTK	RECTK_6 ⁵	RECTKFRT ⁶	RH	ROSFLUT	RT

RW	SBCADDY	SBCADDYSM	SCPDRW	SRT	STW	TD	TKP	TVR	UDBX	URT	VTK	WS ⁶	WTCD	WTKCUP	WTR

¹ Not available on 12" wide.

² Only available on 24" wide.

³ 6" fluting not available on 12", 15" or 18" wide and fluting both 6" not available on 21" wide.

⁴ FTKAV and style B-L not available on 12" wide.

⁵ 12" wide can only be recessed in front and/or back. 15" and 18" wide can only be recessed in the front, back, and/or one side only.

⁶ Not available on 12" wide. Not available on wide stile 1.5" version except wide stile both 1.5" is available on 15"-24" wide.

FOUR DRAWER BASE with WOOD TIERED CUTLERY DIVIDER, 34 1/2" HIGH, 24" DEEP

L O G I X

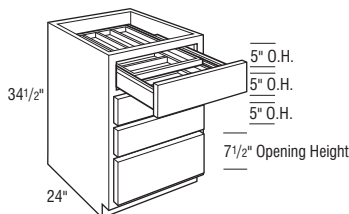

4DB15WTC	9.1	2417	2486	2532	2625	2845	3026	3207
4DB18WTC	10.8	2524	2604	2646	2746	2988	3176	3364
4DB21WTC	12.4	2637	2719	2772	2881	3135	3339	3543
4DB24WTC	14.1	2764	2854	2905	3018	3296	3515	3734

4DB30WTC	17.4	3499	3626	3697	3852	4226	4540	4854
4DB36WTC	20.7	3624	3758	3838	3999	4396	4725	5054

• Includes Wood Tiered Cutlery Divider Drawer.

• Exterior WTC drawer box height is 3 3/4", interior height of top and bottom tier is 1 3/8".

• Wood Tiered Cutlery Divider Drawer is also available as an accessory for field installation. See page S•5.

• Different sizes of the cutlery dividers may have different configurations. Please reference the accessory section on page S•5 for more details.

Door & Drawer Options

AF	AOMBWB	CC	CG	GAMD	IFHG	MD	PRMD	PTOWB	SHMD	SPLITDR	SPLITDRWS	TCP

End Panel Options

AUTH	CSFPE	EXBK	FFD	FL/FR	FPE	INTGE	IPE
✓	✓	✓	✓	✓	✓	✓	✓

Custom Modification Options

ADD_SHLF	ADDTK	CBO	CCO	CFNTD	CFP	CFRMO	CHGDRW	CLIP ¹	CMAT	CND	CSDGBK	DRT	DRWSEC	DRWTK	EX	EX_OL	FBFL	FD

FDSRTBTM	FLUT ²	FTK	ID	IH	INVFRM	IW	LIGHT	MIP	OBRB	PFINBTMB	RD	RECTK	RECTK_6 ³	RECTKFRT ⁶	RH	ROSFLUT ³	RT

RW	SBCADDY	SBCADDYSM	SCPDRW	SRT	STW	TD	TKP	TVR	UDBX	URT	VTK	WS ⁴	WTCD	WTKCUP	WTR

¹ Not available on 15" wide. CLIPL&R and 6" dipped not available on 15" or 18" wide. CLIP6L&R only available on 30" and 36" wide. CLIPL and CLIPR not available on 30" and 36" wide.

² Not available on 15" wide. FLUT3B and 6" fluting not available on 15" or 18" wide. FLUT6B only available on 30" and 36" wide. FLUT3L and FLUT3R not available on 30" and 36" wide.

³ 15" and 18" wide can only be recessed in the front, back, and/or one side only.

⁴ Not available on 15" wide. Wide Stile both only available on 30" and 36" wide. WSL&R3 only available on 30" and 36" wide.

Drawer Base Cabinets

FOUR DRAWER BASE with WOOD TIERED K-CUP* DRAWER, 34 1/2" HIGH, 24" DEEP

L G I X

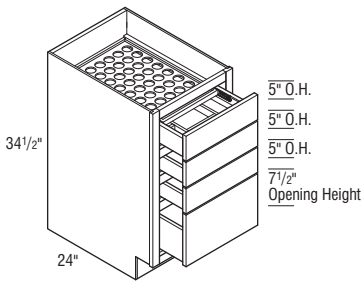

Cubic Feet	1	2	3	4	5	6	7	
4DB18KUP	10.8	2548	2669	2735	2893	3068	3344	3620

- Holds 40 K-Cups.
- The Wood Tiered K-Cup Drawer is compatible with K-Cup pods only.
- Exterior Wood Tiered K-Cup drawer box height is 3 3/4", interior height of top tier is 1 5/8", and interior height of bottom tier is 1 3/8".
- The K-Cup drawer will be positioned in the top drawer.

*K-Cup is a registered trademark of Keurig Green Mountain, Inc.

Door & Drawer Options

AF	AOMBWB	CC	CG	GAMD	IFHG	MD	PRMD	PTOWB	SHMD	SPLITDR	SPLITDRWS	TCP

End Panel Options

AUTH	CSFPE	EXBK	FFD	FL/FR	FPE	INTGE	IPE

Custom Modification Options

ADD	SHLF	ADDTK	CBO	CCO	CFNTD	CFP	CFRMO	CHGDRW	CLIP	CMAT	CND	CSDGBK	DRT	DRWSEC	DRWTK	EX	EX_OL	FBFL	FD	

FDSRTBTM	FLUT ¹	FTK	ID	IH	INVFRM	IW	LIGHT	MIP	OBRB	PFINBTMB	RD	RECTK	RECTK_6 ²	RECTKFR6	RH	ROSLUT	RT

RW	SBCADDY	SBCADDYSM	SCPDRW	SRT	STW	TD	TKP	TVR	UBX	URT	VTK	WS	WTCB	WTKCUP	WTR

¹ Not available with 6" fluting.

² Can only be recessed in the front, back, and/or one side only.

FOUR DRAWER BASE with CUTLERY INSERT WOOD DIVIDERS, 34 1/2" HIGH, 24" DEEP

L G I X

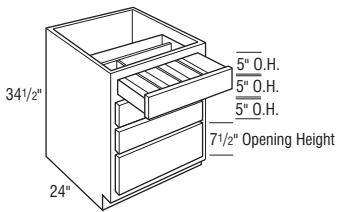

4DB15CIW	9.1	1635	1704	1750	1843	2063	2244	2425
4DB18CIW	10.8	1742	1822	1864	1964	2206	2394	2582
4DB21CIW	12.4	1882	1964	2017	2126	2380	2584	2788
4DB24CIW	14.1	2041	2131	2182	2295	2573	2792	3011

- Includes Cutlery Insert Wood Divider.
- Features hard wood.
- Exterior height for bottom drawer box is 6 3/8".
- Cutlery Insert Wood Divider is also available as an accessory for field installation. See page S•5.

Door & Drawer Options

AF	AOMBWB	CC	CG	GAMD	IFHG	MD	PRMD	PTOWB	SHMD	SPLITDR	SPLITDRWS ¹	TCP

End Panel Options

AUTH	CSFPE	EXBK	FFD	FL/FR	FPE	INTGE	IPE

Custom Modification Options

ADD	SHLF	ADDTK	CBO	CCO	CFNTD	CFP	CFRMO	CHGDRW	CLIP	CMAT	CND	CSDGBK	DRT	DRWSEC	DRWTK	EX	EX_OL	FBFL	FD	

FDSRTBTM	FLUT ²	FTK	ID	IH	INVFRM	IW	LIGHT	MIP	OBRB	PFINBTMB	RD	RECTK	RECTK_6 ³	RECTKFR6	RH	ROSLUT	RT

RW	SBCADDY	SBCADDYSM	SCPDRW	SRT	STW	TD	TKP	TVR	UBX ¹	URT	VTK	WS	WTCB	WTKCUP	WTR

¹ Not available on 15", 18", or 21" wide.

² Not available on 15" wide and FLUT6B not available on 18" or 21" wide.

³ 15" and 18" wide can only be recessed in the front, back, and/or one side only.

IH/RH availability charts starting on page G•40.
IW/RW availability charts starting on page G•46.

FOUR DRAWER BASE with CHARGING DRAWER, 34 1/2" HIGH, 24" DEEP

L G I X

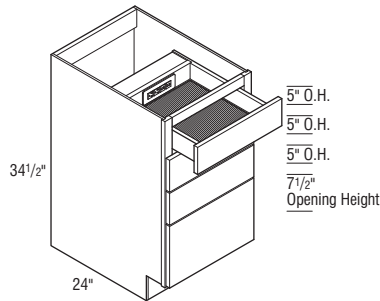

Cubic Feet	1	2	3	4	5	6	7	
4DB18CHGDRW	10.8	2874	2954	2996	3096	3338	3526	3714

- The charging drawer will be positioned in the top drawer.
- Charging drawer has full extension, concealed Smart Stop slides.
- 110 lb. rated.
- 120V outlet must be installed in rear of cabinet within 10" of bottom of drawer, in rear of cabinet.
- CUL US listed power strip with two 120V plugs and two 2.1 amp USB ports.
- Max Current: AC 15 amps @ 120VAC; USB 2.1 amp and 5 VDC each.
- Tamper resistant outlets.
- Power cord with NEMA 5-15 plug.
- Integrated cord guide mounts to cabinet side to ensure safe operation.
- Black, shock absorbing mat included.
- Special sizes not available.
- Only available in 24" deep.
- Not available on Inset or Beaded Inset Styles.

Door & Drawer Options

AF	AOMBWB	CC	CG	GAMD	IFHG	MD	PRMD	PTOWB	SHMD	SPLITDR	SPLITDRWS	TCP
----	--------	----	----	------	------	----	------	-------	------	---------	-----------	-----

End Panel Options

AUTH	CSFPE	EXBK	FFD	FL/FR	FPE	INTGE	IPE
✓	✓	✓	✓	✓	✓	✓	✓

Custom Modification Options

ADD_SHLF	ADDTK	CBO	CCO	CFNTD	CFP	CFRMO	CHGDRW	CLIP	CMAT	CND	CSDGBK	DRT	DRWSEC	DRWTK	EX	EX_OL	FBFL	FD
		✓	✓	✓										✓	✓	✓		

FDSRTBTM	FLUT	FTK	ID	IH	INVRM	IW	LIGHT	MIP	OBRB	PFINBTMB	RD	RECTK	RECTK_6 ¹	RECTKRT6	RH	ROSFLUT	RT
	✓	✓	✓					✓	✓			✓	✓	✓	✓		

RW	SBCADDY	SBCADDYSM	SCPDRW	SRT	STW	TD	TKP	TVR	UDBX	URT	VTK	WS	WTCD	WTKCUP	WTR
			✓					✓			✓				✓

¹ Can only be recessed in the front, back, and/or one side only.

THREE DRAWER BASE, 34 1/2" HIGH, 24" DEEP

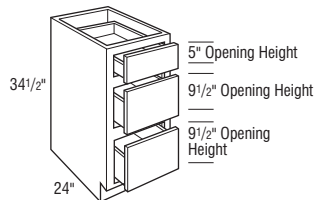

3DB12	7.5	1356	1420	1469	1550	1642	1794	1946
3DB15	9.1	1474	1546	1600	1685	1786	1951	2116
3DB18	10.8	1603	1680	1741	1835	1945	2123	2301
3DB21	12.4	1698	1778	1842	1944	2058	2245	2432
3DB24	14.1	1802	1887	1954	2062	2184	2384	2584

- Reduced Depths available in 1/4" increments from 12" to 23 3/4".

Door & Drawer Options

AF	AOMBWB	CC	CG	GAMD	IFHG	MD	PRMD	PTOWB	SHMD	SPLITDR	SPLITDRWS	TCP
				✓								

End Panel Options

AUTH	CSFPE	EXBK	FFD	FL/FR	FPE	INTGE	IPE
✓	✓	✓	✓	✓	✓	✓	✓

Custom Modification Options

ADD_SHLF	ADDTK	CBO	CCO	CFNTD	CFP	CFRMO	CHGDRW	CLIP ¹	CMAT	CND	CSDGBK	DRT	DRWSEC ²	DRWTK ³	EX	EX_OL	FBFL	FD
		✓	✓	✓	✓	✓		✓					✓	✓	✓	✓		

FDSRTBTM	FLUT ⁴	FTK ⁵	ID	IH	INVRM	IW	LIGHT	MIP	OBRB	PFINBTMB	RD	RECTK	RECTK_6 ⁶	RECTKRT6	RH	ROSFLUT	RT
	✓	✓	✓					✓	✓			✓	✓	✓	✓		

RW	SBCADDY	SBCADDYSM	SCPDRW	SRT	STW	TD	TKP	TVR	UDBX	URT	VTK	WS ⁷	WTCD	WTKCUP	WTR
			✓					✓			✓	✓			✓

¹ Not available on 12" wide.

² Only available on 18"-24" wide.

³ Only available on 24" wide.

⁴ 6" fluting not available on 12" or 15" wide and 6" fluting both not available on 18" or 21" wide.

⁵ FTKAV and style B-L not available on 12" wide.

⁶ 12" wide can only be recessed in front and/or back. 15" and 18" wide can only be recessed in the front, back, and/or one side only.

⁷ Not available on 12" wide.

Drawer Base Cabinets

THREE DRAWER BASE, 34 1/2" HIGH, 24" DEEP

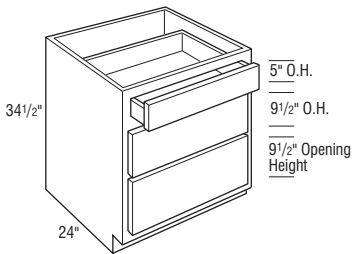

	Cubic Feet	1	2	3	4	5	6	7
3DB27	15.7	2266	2374	2458	2591	2747	2998	3249
3DB30	17.4	2506	2624	2716	2864	3032	3315	3598
3DB33	19.0	2561	2685	2781	2932	3106	3390	3674
3DB36	20.7	2615	2742	2837	2993	3171	3464	3757
3DB39	22.4	2673	2805	2901	3061	3242	3540	3838
3DB42	24.0	2732	2865	2965	3127	3313	3619	3925

• Reduced Depths available in 1/4" increments from 12" to 23 3/4".

Door & Drawer Options

AF	AOMBWB	CC	CG	GAMD	IFHG	MD	PRMD	PTOWB	SHMD	SPLITDR	SPLITDRWS	TCP

End Panel Options

AUTH	CSFPE	EXBK	FFD	FL/FR	FPE	INTGE	IPE

Custom Modification Options

ADD	SHLF	ADTK	CBO	CCO	CFNT0	CFP	CFRMO	CHGDRW ¹	CLIP	CMAT	CND	CSDGBK	DRT	DRWSEC	DRWTK ²	EX	EX_OL	FBFL	FD	

FDSRTBTM	FLUT	FTK	ID	IH	INVFRM	IW ³	LIGHT	MIP	OBRB	PFINBTMB	RD	RECTK	RECTK_6	RECTKFRT6	RH	ROSFLUT	RT

RW	SBCADDY	SBCADDYSM	SCPDRW	SRT	STW	TD	TKP	TVR	UDBX	URT	VTK	WS	WTCO ²	WTKCUP ⁴	WTR

¹ Only available with 36" wide. 36" wide only available in conjunction with SPLITDRWS modification.

² Not available on 27", 33", 39", or 42" wide.

³ Not available on 42" wide.

⁴ Only available on 36" wide.

THREE DRAWER BASE BUFFET, 34 1/2" HIGH, 24" DEEP

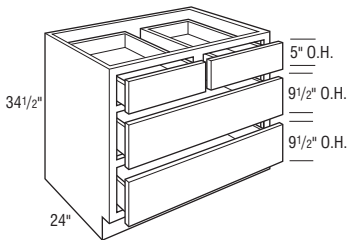

3DBB30	17.4	2506	2624	2716	2864	3032	3315	3598
3DBB33	19.0	2561	2685	2781	2932	3106	3390	3674
3DBB36	20.7	2615	2742	2837	2993	3171	3464	3757

• Scoop drawer option available in top drawer only.

Door & Drawer Options

AF	AOMBWB	CC	CG	GAMD	IFHG	MD	PRMD	PTOWB	SHMD	SPLITDR	SPLITDRWS	TCP

End Panel Options

AUTH	CSFPE	EXBK	FFD	FL/FR	FPE	INTGE	IPE

Custom Modification Options

ADD	SHLF	ADTK	CBO	CCO	CFNT0	CFP	CFRMO	CHGDRW ¹	CLIP	CMAT	CND	CSDGBK	DRT	DRWSEC	DRWTK	EX	EX_OL	FBFL	FD	

FDSRTBTM	FLUT	FTK	ID	IH	INVFRM	IW	LIGHT	MIP	OBRB	PFINBTMB	RD	RECTK	RECTK_6	RECTKFRT6	RH	ROSFLUT	RT

RW	SBCADDY	SBCADDYSM	SCPDRW	SRT	STW	TD	TKP	TVR	UDBX	URT	VTK	WS	WTCO ²	WTKCUP ¹	WTR

¹ Only available on 36" wide.

² Only available on 30" or 36" wide.

IH/RH availability charts starting on page G-40.
IW/RW availability charts starting on page G-46.

THREE DRAWER BASE with DEEP DRAWER, 34 1/2" HIGH, 24" DEEP

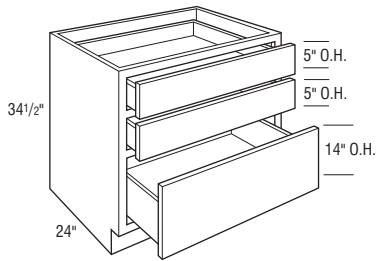

	Cubic Feet	1	2	3	4	5	6	7
3DBDD24	14.1	3015	3161	3274	3452	3656	3991	4326
3DBDD27	15.8	3290	3449	3572	3766	3990	4354	4718
3DBDD30	17.4	3564	3737	3871	4081	4323	4718	5113
3DBDD33	19.0	3835	4021	4165	4391	4651	5077	5503
3DBDD36	20.7	4128	4327	4482	4725	5006	5464	5922

- Exterior height for bottom drawer box is 10".
- Scoop drawer option available in top drawer only.
- Reduced Depths available in 1/4" increments from 12" to 23 3/4".

Door & Drawer Options

AF	AOMBWB	CC	CG	GAMD	IFHG	MD	PRMD	PTOWB	SHMD	SPLITDR	SPLITDRWS	TCP
----	--------	----	----	------	------	----	------	-------	------	---------	-----------	-----

End Panel Options

AUTH	CSFPE	EXBK	FFD	FL/FR	FPE	INTGE	IPE
------	-------	------	-----	-------	-----	-------	-----

Custom Modification Options

ADD_SHLF	ADDTK	CBO	CCO	CFNT0	CFP	CFRMO	CHGDRW	CLIP	CMAT	CND	CSDGBK	DRT	DRWSEC	DRWTK	EX	EX_OL	FBFL	FD
----------	-------	-----	-----	-------	-----	-------	--------	------	------	-----	--------	-----	--------	-------	----	-------	------	----

FDSRTBTM	FLUT ¹	FTK	ID	IH	INVFRM	IW ²	LIGHT	MIP	OBRB	PFINBTMB	RD	RECTK	RECTK_6	RECTKFRT6	RH	ROSFLUT	RT
----------	-------------------	-----	----	----	--------	-----------------	-------	-----	------	----------	----	-------	---------	-----------	----	---------	----

RW	SBCADDY	SBCADDYSM	SCPDRW	SRT	STW	TD	TKP	TVR	UDBX	URT	VTK	WS	WTCD ³	WTKCUP	WTR
----	---------	-----------	--------	-----	-----	----	-----	-----	------	-----	-----	----	-------------------	--------	-----

- ¹ Not available with 6" fluting.
² Not available on 36" wide.
³ Only available on 24" wide.

THREE DRAWER BASE with WOOD TIERED CUTLERY DIVIDER, 34 1/2" HIGH, 24" DEEP

L G I X

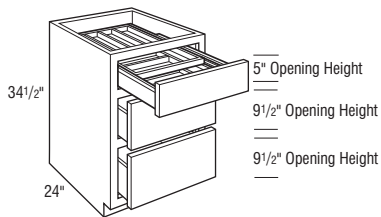

3DB15WTCD	9.1	1974	2046	2100	2185	2286	2451	2616
3DB18WTCD	10.8	2103	2180	2241	2335	2445	2623	2801
3DB21WTCD	12.4	2198	2278	2342	2444	2558	2745	2932
3DB24WTCD	14.1	2702	2787	2854	2962	3084	3284	3484

3DB30WTCD	17.4	3406	3524	3616	3764	3932	4215	4498
3DB36WTCD	20.7	3515	3642	3737	3893	4071	4364	4657

- Includes Wood Tiered Cutlery Divider Drawer.
- Exterior WTCD drawer box height is 3 3/4", interior height of top and bottom tier is 1 3/8".
- Wood Tiered Cutlery Divider Drawer is also available as an accessory for field installation. See page S•5.
- Different sizes of the cutlery dividers may have different configurations. Please reference the accessory section on page S•5 for more details.

Door & Drawer Options

AF	AOMBWB	CC	CG	GAMD	IFHG	MD	PRMD	PTOWB	SHMD	SPLITDR	SPLITDRWS	TCP
----	--------	----	----	------	------	----	------	-------	------	---------	-----------	-----

End Panel Options

AUTH	CSFPE	EXBK	FFD	FL/FR	FPE	INTGE	IPE
------	-------	------	-----	-------	-----	-------	-----

Custom Modification Options

ADD_SHLF	ADDTK	CBO	CCO	CFNT0	CFP	CFRMO	CHGDRW	CLIP ¹	CMAT	CND	CSDGBK	DRT	DRWSEC	DRWTK	EX	EX_OL	FBFL	FD
----------	-------	-----	-----	-------	-----	-------	--------	-------------------	------	-----	--------	-----	--------	-------	----	-------	------	----

FDSRTBTM	FLUT ²	FTK	ID	IH	INVFRM	IW	LIGHT	MIP	OBRB	PFINBTMB	RD	RECTK	RECTK_6 ³	RECTKFRT6	RH	ROSFLUT ²	RT
----------	-------------------	-----	----	----	--------	----	-------	-----	------	----------	----	-------	----------------------	-----------	----	----------------------	----

RW	SBCADDY	SBCADDYSM	SCPDRW	SRT	STW	TD	TKP	TVR	UDBX	URT	VTK	WS ⁴	WTCD	WTKCUP	WTR
----	---------	-----------	--------	-----	-----	----	-----	-----	------	-----	-----	-----------------	------	--------	-----

- ¹ Not available on 15" wide. CLIPL&R and 6" clipped not available on 15" or 18" wide. CLIP6L&R only available on 30" and 36" wide. CLIPL and CLIPR not available on 30" and 36" wide.
² Not available on 15" wide. FLUT3B and 6" fluting not available on 15" or 18" wide. FLUT6B only available on 30" and 36" wide. FLUT3L and FLUT3R not available on 30" and 36" wide.
³ 15" and 18" wide can only be recessed in front and/or back.
⁴ Not available on 15" wide. Wide Stile both only available on 30" and 36" wide. WSL&R3 only available on 30" and 36" wide.

Drawer Base Cabinets

Cubic Feet	1	2	3	4	5	6	7
------------	---	---	---	---	---	---	---

THREE DRAWER BASE with WOOD TIERED K-CUP* DRAWER, 34 1/2" HIGH, 24" DEEP

L O G I X

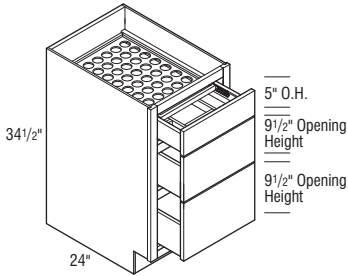

3DB18KCP

- Holds 40 K-Cups.
- The Wood Tiered K-Cup Drawer is compatible with K-Cup pods only.
- Exterior Wood Tiered K-Cup drawer box height is 3 3/4", interior height of top tier is 1 5/8", and interior height of bottom tier is 1 3/8".
- The K-Cup drawer will be positioned in the top drawer.

*K-Cup is a registered trademark of Keurig Green Mountain, Inc.

Door & Drawer Options

AF	AOMBWB	CC	CG	GAMD	IFHG	MD	PRMD	PTOWB	SHMD	SPLITDR	SPLITDRWS	TCP
					✓							

End Panel Options

AUTH	CSFPE	EXBK	FFD	FL/FR	FPE	INTGE	IPE
✓	✓	✓	✓	✓	✓	✓	✓

Custom Modification Options

ADD	SHLF	ADDTK	CBO	CCO	CFNTD	CFP	CFRMO	CHGDRW	CLIP	CMAT	CND	CSDGBK	DRT	DRWSEC	DRWTK	EX	EX_OL	FBFL	FD
															✓	✓	✓		

FDSRTBTM	FLUT ¹	FTK	ID	IH	INVFRM	IW	LIGHT	MIP	OBRB	PFINBTMB	RD	RECTK	RECTK_6 ²	RECTKRT6	RH	ROSLUT	RT
	✓	✓	✓					✓	✓			✓	✓	✓		✓	

RW	SBCADDY	SBCADDYSM	SCPDRW	SRT	STW	TD	TKP	TVR	UDBX	URT	VTK	WS	WTCD	WTKCUP	WTR
								✓			✓				✓

¹ Not available with 6" fluting.

² Can only be recessed in the front, back, and/or one side only.

THREE DRAWER BASE with BREAD BOARD, 34 1/2" HIGH, 24" DEEP

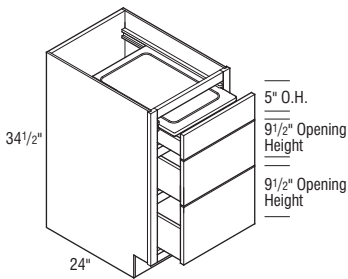

3DB12BB

3DB15BB

3DB18BB

3DB21BB

3DB24BB

7.5	1897	1989	2062	2175	2303	2514	2725
9.1	1944	2035	2107	2222	2352	2572	2792
10.8	2015	2111	2186	2307	2441	2667	2893
12.4	2212	2319	2400	2530	2679	2930	3181
14.1	2379	2492	2581	2721	2884	3147	3410

Door & Drawer Options

AF	AOMBWB	CC	CG	GAMD	IFHG	MD	PRMD	PTOWB	SHMD	SPLITDR	SPLITDRWS	TCP
					✓							

End Panel Options

AUTH	CSFPE	EXBK	FFD	FL/FR	FPE	INTGE	IPE
✓	✓	✓	✓	✓	✓	✓	✓

Custom Modification Options

ADD	SHLF	ADDTK	CBO	CCO	CFNTD	CFP	CFRMO	CHGDRW	CLIP ¹	CMAT	CND	CSDGBK	DRT	DRWSEC	DRWTK ²	EX	EX_OL	FBFL	FD
									✓						✓	✓	✓		

FDSRTBTM	FLUT ³	FTK ⁴	ID	IH	INVFRM	IW	LIGHT	MIP	OBRB	PFINBTMB	RD	RECTK	RECTK_6 ⁵	RECTKRT6	RH	ROSLUT	RT
	✓	✓	✓					✓	✓			✓	✓	✓		✓	

RW	SBCADDY	SBCADDYSM	SCPDRW	SRT	STW	TD	TKP	TVR	UDBX	URT	VTK	WS ⁶	WTCD	WTKCUP	WTR ⁷
								✓			✓	✓			✓

¹ Not available on 12" wide.

² Only available on 24" wide.

³ 6" fluting not available on 12" or 15" and fluting both 6" not available on 18" or 21" wide.

⁴ FTKAV and style B-L not available on 12" wide.

⁵ 12" wide can only be recessed in front and/or back. 15" and 18" wide can only be recessed in the front, back, and/or one side only.

⁶ Not available on 12" wide. Not available on 1.5" except wide stile both 1.5".

⁷ Not available on 18" or 24" wide.

IH/RH availability charts starting on page G-40.
IW/RW availability charts starting on page G-46.

THREE DRAWER BASE with CHARGING DRAWER, 34 1/2" HIGH, 24" DEEP

L O G I X

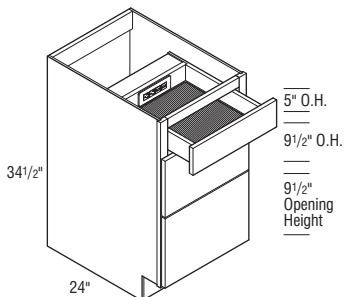

3DB18CHGDRW

Cubic Feet	1	2	3	4	5	6	7
10.8	2853	2930	2991	3085	3195	3373	3551

- The charging drawer will be positioned in the top drawer.
- Charging drawer has full extension, concealed Smart Stop slides.
- 110 lb. rated.
- 120V outlet must be installed in rear of cabinet within 10" of bottom of drawer, in rear of cabinet.
- CUL US listed power strip with two 120V plugs and two 2.1 amp USB ports.
- Max Current: AC 15 amps @ 120VAC; USB 2.1 amp and 5 VDC each.
- Tamper resistant outlets.
- Power cord with NEMA 5-15 plug.
- Integrated cord guide mounts to cabinet side to ensure safe operation.
- Black, shock absorbing mat included.
- Special sizes not available.
- Only available in 24" deep.
- Not available on Inset or Beaded Inset Styles.

Door & Drawer Options

AF	AOMBWB	CC	CG	GAMD	IFHG	MD	PRMD	PTOWB	SHMD	SPLITDR	SPLITDRWS	TCP
----	--------	----	----	------	------	----	------	-------	------	---------	-----------	-----

End Panel Options

AUTH	CSFPE	EXBK	FFD	FL/FR	FPE	INTGE	IPE
✓	✓	✓	✓	✓	✓	✓	✓

Custom Modification Options

ADD_SHLF	ADDTK	CBO	CCO	CFNTO	CFP	CFRMO	CHGDRW	CLIP	CMAT	CND	CSDGBK	DRT	DRWSEC	DRWTK	EX	EX_OL	FBFL	FD
		✓	✓	✓										✓	✓	✓		

FDSRTBTM	FLUT	FTK	ID	IH	INVFRM	IW	LIGHT	MIP	OBRB	PFINBTMB	RD	RECTK	RECTK_6 ¹	RECTKRT6	RH	ROSFLUT	RT
	✓	✓						✓	✓			✓	✓	✓	✓		

RW	SBCADDY	SBCADDYSM	SCPDWR	SRT	STW	TD	TKP	TVR	UDBX	URT	VTK	WS	WTCB	WTKCUP	WTR
									✓		✓			✓	✓

¹ Can only be recessed in the front, back, and/or one side only.

THREE DRAWER BASE BUFFET with DEEP DRAWER, 34 1/2" HIGH, 24" DEEP

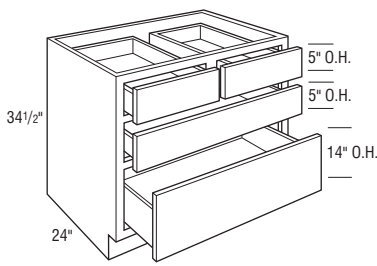

3DBBDD30

17.4	4071	4268	4421	4661	4937	5389	5841
3DBBDD33	19.0	4383	4595	4759	5018	5316	6288
3DBBDD36	20.7	4720	4949	5125	5404	5724	6772

- Exterior height for bottom drawer box is 10".
- Scoop drawer option available in top drawer only.
- Reduced Depths available in 1/4" increments from 12" to 23 3/4".

Door & Drawer Options

AF	AOMBWB	CC	CG	GAMD	IFHG	MD	PRMD	PTOWB	SHMD	SPLITDR	SPLITDRWS	TCP
----	--------	----	----	------	------	----	------	-------	------	---------	-----------	-----

End Panel Options

AUTH	CSFPE	EXBK	FFD	FL/FR	FPE	INTGE	IPE
✓	✓	✓	✓	✓	✓	✓	✓

Custom Modification Options

ADD_SHLF	ADDTK	CBO	CCO	CFNTO	CFP	CFRMO	CHGDRW	CLIP	CMAT	CND	CSDGBK	DRT	DRWSEC	DRWTK	EX	EX_OL	FBFL	FD
		✓	✓	✓	✓	✓								✓	✓	✓		

FDSRTBTM	FLUT ¹	FTK	ID	IH	INVFRM	IW ²	LIGHT	MIP	OBRB	PFINBTMB	RD	RECTK	RECTK_6	RECTKRT6	RH	ROSFLUT	RT
	✓	✓						✓	✓			✓	✓	✓	✓		

RW	SBCADDY	SBCADDYSM	SCPDWR	SRT	STW	TD	TKP	TVR	UDBX	URT	VTK	WS	WTCB	WTKCUP	WTR
									✓		✓			✓	✓

¹ Not available with 6" fluting.

² Not available on 36" wide.

Drawer Base Cabinets

TWO DRAWER BASE, 34 1/2" HIGH, 24" DEEP

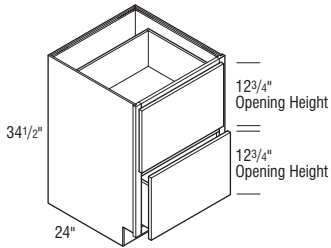

	Cubic Feet	1	2	3	4	5	6	7
2DB18	10.8	1960	2053	2126	2240	2373	2594	2815
2DB21	12.4	2019	2116	2188	2309	2447	2669	2891
2DB24	14.1	2078	2176	2254	2375	2519	2749	2979
2DB27	15.7	2720	2852	2954	3114	3297	3599	3901
2DB30	17.4	2777	2909	3013	3180	3366	3676	3986
2DB33	19.0	2876	3016	3125	3291	3488	3809	4130
2DB36	20.7	2934	3077	3182	3357	3558	3884	4210
2DB39	22.4	2998	3144	3254	3431	3635	3970	4305
2DB42	24.0	3064	3213	3323	3504	3714	4055	4396
2DB45	25.7	3128	3280	3393	3579	3791	4140	4489
2DB48	27.3	3192	3347	3463	3652	3870	4226	4582

- Utilizes 10" high drawer box height.
- Reduced Depths available in 1/4" increments from 12" to 23 3/4".

Door & Drawer Options

AF	AOMBWB	CC	CG	GAMD	IFHG	MD	PRMD	PTOWB	SHMD	SPLITDR	SPLITDRWS	TCP
					✓							

End Panel Options

AUTH	CSFPE	EXBK	FFD	FL/FR	FPE	INTGE	IPE
✓	✓	✓	✓	✓	✓	✓	✓

Custom Modification Options

ADD	SHLF	ADDTK	CBO	CCO	CFNT0	CFP	CFRMO	CHGDRW	CLIP	CMAT	CND	CSDGBK	DRT	DRWSEC	DRWTK ¹	EX	EX_OL	FBFL	FD	
FDSRTBTM	FLUT	FTK	ID	IH	INFRM	IW ²	LIGHT	MIP	OBRB	PFINBTMB	RD	RECTK	RECTK_6 ³	RECTKFT6	RH	ROSLUT	RT			
RW	SBCADDY	SBCADDYSM	SCPDRW	SRT	STW	TD	TKP	TVR	UDBX	URT	VTK	WS	WTCO	WTKCUP	WTR					

¹ Only available on 18"-36" wide.

² Not available on 48" wide.

³ 18" wide can only be recessed in the front, back, and/or one side only.

TWO DRAWER BASE with PEGGED DISH ORGANIZER, 34 1/2" HIGH, 24" DEEP

L O G I X

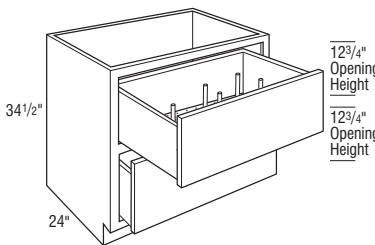

2DB36PDO	21.1	4151	4352	4508	4752	5034	5495	5956
-----------------	------	------	------	------	------	------	------	------

- Utilizes 10" high drawer box height.
- Cabinet not applicable for stove top installation.
- Includes 8 wooden posts and 19/32" thick removable pegged board in top drawer, shipped loose.
- Pegged board dimensions: 29 15/16" W x 19 1/2" D.

Door & Drawer Options

AF	AOMBWB	CC	CG	GAMD	IFHG	MD	PRMD	PTOWB	SHMD	SPLITDR	SPLITDRWS	TCP

End Panel Options

AUTH	CSFPE	EXBK	FFD	FL/FR	FPE	INTGE	IPE
✓	✓	✓	✓	✓	✓	✓	✓

Custom Modification Options

ADD	SHLF	ADDTK	CBO	CCO	CFNT0	CFP	CFRMO	CHGDRW	CLIP	CMAT	CND	CSDGBK	DRT	DRWSEC	DRWTK	EX	EX_OL	FBFL	FD	
FDSRTBTM	FLUT ¹	FTK	ID	IH	INFRM	IW	LIGHT	MIP	OBRB	PFINBTMB	RD	RECTK	RECTK_6	RECTKFT6	RH	ROSLUT	RT			
RW	SBCADDY	SBCADDYSM	SCPDRW	SRT	STW	TD	TKP	TVR	UDBX	URT	VTK	WS	WTCO	WTKCUP	WTR					

¹ Not available with 6" fluting.

IH/RH availability charts starting on page G•40.
IW/RW availability charts starting on page G•46.

TWO DRAWER BASE with ROLL TRAYS, 34 1/2" HIGH, 24" DEEP

L G I X

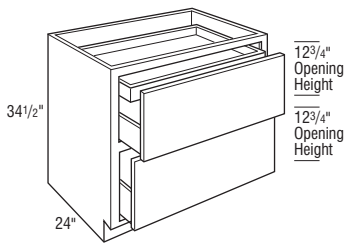

	Cubic Feet	1	2	3	4	5	6	7
2DB18RT	10.8	1998	2094	2169	2283	2420	2646	2872
2DB21RT	12.4	2058	2156	2230	2352	2491	2721	2951
2DB24RT	14.1	2117	2218	2296	2420	2566	2800	3034
2DB27RT	15.7	2759	2891	2994	3157	3345	3652	3959
2DB30RT	17.4	2816	2951	3056	3224	3414	3727	4040
2DB33RT	19.0	2914	3057	3166	3335	3534	3862	4190
2DB36RT	20.7	2934	3077	3182	3357	3558	3884	4210

- Cabinet not applicable for stove top installation.
- Roll tray can be removed and installed above lower drawers.
- Reduced Depths available in 1/4" increments from 12" to 23 3/4".

Door & Drawer Options

AF	AOMBWB	CC	CG	GAMD	IFHG	MD	PRMD	PTOWB	SHMD	SPLITDR	SPLITDRWS	TCP

End Panel Options

AUTH	CSFPE	EXBK	FFD	FL/FR	FPE	INTGE	IPE
✓	✓	✓	✓	✓	✓	✓	✓

Custom Modification Options

ADD_SHLF	ADDTK	CBO	CCO	CFNTO	CFP	CFRMO	CHGDRW	CLIP	CMAT	CND	CSDGBK	DRT	DRWSEC	DRWTK ¹	EX	EX_OL	FBFL	FD
FDSRTBTM	FLUT ²	FTK	ID	IH	INVFRM	IW	LIGHT	MIP	OBRB	PFINBTMB	RD	RECTK	RECTK	6 ³	RECTKERT6	RH	ROSFLUT	RT
RW ⁴	SBCADDY	SBCADDYSM	SCPDRW	SRT	STW	TD	TKP	TVR	UDBX	URT	VTK	WS	WTCB	WTKCUP	WTR			
✓																		

¹ Only available on 24", 30" and 36" wide.
² 6" fluting not available on 18"-27" wide.
³ 18" wide can only be recessed in the front, back, and/or one side only.
⁴ Only available on 18" and 24" wide.

TWO DRAWER BASE with ROLL TRAY and PEGGED DISH ORGANIZER, 34 1/2" HIGH, 24" DEEP

L G I X

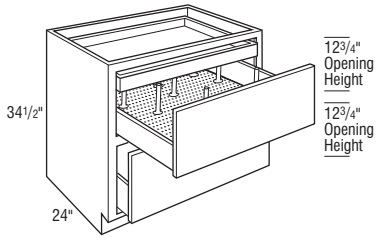

2DB36RTPDO	20.7	3447	3617	3740	3945	4178	4565	4952
-------------------	------	------	------	------	------	------	------	------

- Cabinet not applicable for stove top installation.
- Roll tray can be removed and installed above lower drawers.
- Includes eight wooden posts and 19/32" thick removable pegged board in top drawer, shipped loose.
- Pegged board dimensions: 29 15/16" W x 19 1/2" D.

Door & Drawer Options

AF	AOMBWB	CC	CG	GAMD	IFHG	MD	PRMD	PTOWB	SHMD	SPLITDR	SPLITDRWS	TCP

End Panel Options

AUTH	CSFPE	EXBK	FFD	FL/FR	FPE	INTGE	IPE
✓	✓	✓	✓	✓	✓	✓	✓

Custom Modification Options

ADD_SHLF	ADDTK	CBO	CCO	CFNTO	CFP	CFRMO	CHGDRW	CLIP	CMAT	CND	CSDGBK	DRT	DRWSEC	DRWTK	EX	EX_OL	FBFL	FD
FDSRTBTM	FLUT ¹	FTK	ID	IH	INVFRM	IW	LIGHT	MIP	OBRB	PFINBTMB	RD	RECTK	RECTK	6	RECTKERT6	RH	ROSFLUT	RT
RW	SBCADDY	SBCADDYSM	SCPDRW	SRT	STW	TD	TKP	TVR	UDBX	URT	VTK	WS	WTCB	WTKCUP	WTR			

¹ Not available with 6" fluting.

Drawer Base Cabinets

TWO DRAWER BASE, 28 1/2" HIGH, 24" DEEP

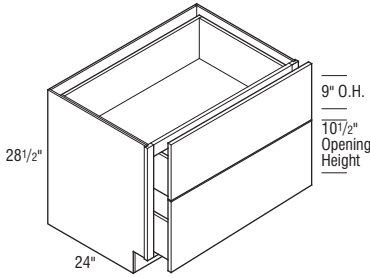

	Cubic Feet	1	2	3	4	5	6	7
2DB2428	11.7	1710	1791	1855	1955	2072	2265	2458
2DB2728	13.1	2156	2261	2339	2467	2614	2855	3096
2DB3028	14.5	2374	2487	2577	2717	2881	3144	3407
2DB3328	15.9	2432	2553	2642	2786	2951	3222	3493
2DB3628	17.3	2485	2607	2699	2847	3014	3291	3568

• Reduced Depths available in 1/4" increments from 12" to 23 3/4".

Door & Drawer Options

AF	AOMBWB	CC	CG	GAMD	IFHG	MD	PRMD	PTOWB	SHMD	SPLITDR	SPLITDRWS	TCP

End Panel Options

AUTH	CSFPE	EXBK	FFD	FL/FR	FPE	INTGE	IPE
✓	✓	✓	✓	✓	✓	✓	✓

Custom Modification Options

ADD_SHLF	ADDTK	CBO	CCO	CFNTO	CFP	CFRMO	CHGDRW	CLIP	CMAT	CND	CSDGBK	DRT	DRWSEC	DRWTK ¹	EX	EX_OL	FBFL	FD

FDSRTBTM	FLUT	FTK	ID	IH	INVFRM	IW	LIGHT	MIP	OBRB	PFINBTMB	RD	RECTK	RECTK_6	RECTKERT6	RH	ROSLUT	RT

RW ²	SBCADDY	SBCADDYSM	SCPDRW	SRT	STW	TD	TKP	TVR	UDBX	URT	VTK	WS	WTCD	WTKCUP	WTR
✓															

¹ Not available on 27" or 33" wide.

² Only available on 24" wide.

IH/RH availability charts starting on page G•40.
IW/RW availability charts starting on page G•46.

Base Pots & Pans Pull-out & Storage Cabinets

BASE POTS and PANS PULL-OUT, 34 1/2" HIGH, 24" DEEP L G I X

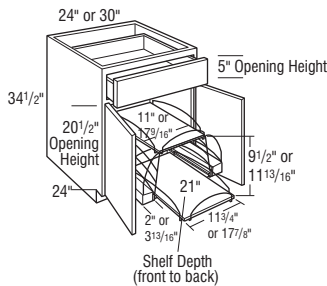
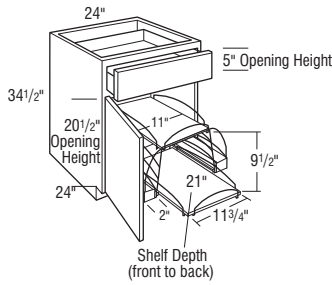

Cubic Feet	1	2	3	4	5	6	7	
BPPP24 L or R	14.1	2132	2212	2276	2373	2480	2657	2834

- Pull-out dimensions: 19 3/4" W x 22 1/4" D x 14 1/2" H.
- Inset and Beaded Inset only available with Finial Hinge.

BPPP24	14.1	2436	2555	2645	2789	2952	3226	3500
---------------	------	------	------	------	------	------	------	------

- Pull-out dimensions: 19 3/4" W x 22 1/4" D x 14 1/2" H.
- Inset and Beaded Inset only available with Finial Hinge.

BPPP30	17.4	3419	3582	3708	3909	4143	4526	4909
---------------	------	------	------	------	------	------	------	------

- Pull-out dimensions: 25 1/2" W x 22 1/4" D x 14 13/16" H.
- Full Extension slide-out shelves pull out independently.
- Inset and Beaded Inset styles will use the 24" pull-out shown above.

Notes below apply to all products in section above:

- Smart Stop feature not available on pull-out.

Door & Drawer Options

AF	AOMBWB	CC	CG	GAMD	IFHG	MD	PRMD	PTOWB	SHMD	SPLITDR	SPLITDRWS	TCP

End Panel Options

AUTH	CSFPE	EXBK	FFD	FL/FR	FPE	INTGE	IPE

Custom Modification Options

ADD_SHLF	ADDTK	CBO	CCO	CFNT0	CFP	CFRMO	CHGDRW	CLIP	CMAT	CND	CSDGBK	DRT	DRWSEC ¹	DRWTK	EX	EX_OL	FBFL	FD	

FDSRTBTM	FLUT ²	FTK	ID	IH	INVFRM	IW	LIGHT	MIP	OBRB	PFINBTMB	RD	RECTK	RECTK_6	RECTKFRT6	RH	ROSLUT	RT	

RW	SBCADDY	SBCADDYSM	SCPDRW	SRT	STW	TD	TKP	TVR	UDBX	URT	VTK	WS	WTCD	WTKCUP	WTR

¹ Only available on 24" wide.

² Not available with 6" fluting.

BASE POTS and PANS STORAGE, 34 1/2" HIGH, 24" DEEP L G I X

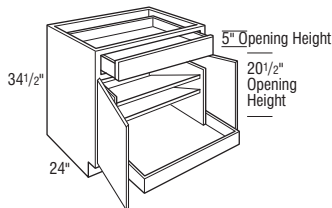

B24PS	14.1	2815	2886	2932	3021	3126	3296	3466
--------------	------	------	------	------	------	------	------	------

B30PS	17.4	3032	3117	3178	3285	3383	3580	3777
--------------	------	------	------	------	------	------	------	------

B36PS	20.7	3126	3214	3285	3392	3501	3704	3907
--------------	------	------	------	------	------	------	------	------

- Reduced Depths available in 3" increments from 15" to 21".
- Not available on Inset and Beaded Inset styles.

Door & Drawer Options

AF	AOMBWB	CC	CG	GAMD	IFHG	MD	PRMD	PTOWB	SHMD	SPLITDR	SPLITDRWS	TCP

End Panel Options

AUTH	CSFPE	EXBK	FFD	FL/FR	FPE	INTGE	IPE

Custom Modification Options

ADD_SHLF	ADDTK	CBO	CCO	CFNT0	CFP	CFRMO	CHGDRW ¹	CLIP	CMAT	CND	CSDGBK	DRT	DRWSEC ²	DRWTK	EX	EX_OL	FBFL	FD	

FDSRTBTM	FLUT ³	FTK	ID	IH	INVFRM	IW	LIGHT	MIP	OBRB	PFINBTMB	RD	RECTK	RECTK_6	RECTKFRT6	RH	ROSLUT	RT	

RW	SBCADDY	SBCADDYSM	SCPDRW	SRT ⁴	STW	TD	TKP	TVR ⁵	UDBX	URT	VTK	WS ⁶	WTCD	WTKCUP ⁷	WTR ⁴

¹ Only available with 36" wide. 36" wide only available in conjunction with SPLITDRWS modification.

² Only available on 24" wide.

³ Not available with 6" fluting.

⁴ Not available on 24" wide.

⁵ Not available on 24" wide. TVRAV and style B-L not available on 36" wide.

⁶ Only available on 30" and 36" wide with wide stile both 3".

⁷ Only available on 36" wide.

Base Lid Organizer & Base Combination Drawer Cabinets

	Cubic Feet	1	2	3	4	5	6	7	
BASE with DRAWER and LID ORGANIZER and ROLL TRAYS, 34 1/2" HIGH, 24" DEEP	B30RTLO	17.4	2821	2904	2965	3069	3170	3365	3560
	B33RTLO	19.0	2865	2952	3024	3127	3230	3426	3622
	B36RTLO	20.7	2913	3002	3069	3180	3289	3491	3693

• Lid Organizer dimensions: 7" W x 19" D x 4 3/8" H.

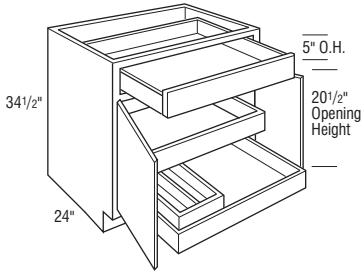

Door & Drawer Options

AF	AOMBWB	CC	CG	GAMD	IFHG	MD	PRMD	PTOWB	SHMD	SPLITDR	SPLITDRWS	TCP
			✓	✓	✓	✓	✓		✓		✓	

End Panel Options

AUTH	CSFPE	EXBK	FFD	FL/FR	FPE	INTGE	IPE
✓	✓	✓	✓	✓	✓	✓	✓

Custom Modification Options

ADD_SHLF	ADDTK	CBO	CCO	CFNT0	CFP	CFRMO	CHGDRW ¹	CLIP	CMAT	CND	CSDGBK	DRT	DRWSEC	DRWTK ²	EX	EX_OL	FBFL	FD
					✓		✓	✓		✓	✓	✓	✓	✓	✓	✓	✓	✓

FDSRTBTM	FLUT	FTK	ID	IH	INVFRM	IW	LIGHT	MIP	OBRB	PFINBTMB	RD	RECTK	RECTK_6	RECTKFRT6	RH	ROSFLUT	RT
	✓	✓	✓	✓	✓	✓	✓	✓	✓	✓	✓	✓	✓	✓	✓	✓	✓

RW	SBCADDY	SBCADDYSM	SCPDRW ³	SRT	STW	TD	TKP	TVR	UDBX	URT	VTK	WS	WTC ⁴	WTKCUP ⁴	WTR
			✓	✓	✓	✓	✓	✓	✓	✓	✓	✓	✓	✓	✓

¹ Only available with 36" wide. 36" wide only available in conjunction with SPLITDRWS modification.

² Not available on 33" wide.

³ Not available on 36" wide.

⁴ Only available on 36" wide.

BASE COMBINATION DRAWER CABINET, 34 1/2" HIGH, 24" DEEP

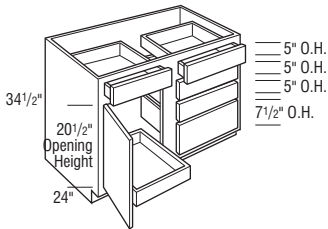

BCD30 L or R	17.4	2693	2820	2912	3066	3232	3522	3812
BCD36 L or R	20.7	2895	3030	3130	3294	3469	3775	4081
BCD42 L or R	24.0	3112	3261	3378	3556	3736	4074	4412
BCD48 L or R	27.3	3392	3556	3679	3874	4078	4454	4830

- Door will be hinged opposite drawer stack.
- Includes one easily adjustable roll tray.
- Reduced Depths available in 1/4" increments from 12" to 23 3/4".

Door & Drawer Options

AF	AOMBWB	CC	CG	GAMD	IFHG	MD	PRMD	PTOWB	SHMD	SPLITDR	SPLITDRWS	TCP
			✓	✓	✓	✓	✓		✓			

End Panel Options

AUTH	CSFPE	EXBK	FFD	FL/FR	FPE	INTGE	IPE
✓	✓	✓	✓	✓	✓	✓	✓

Custom Modification Options

ADD_SHLF	ADDTK	CBO	CCO	CFNT0	CFP	CFRMO	CHGDRW ¹	CLIP	CMAT	CND	CSDGBK	DRT	DRWSEC ²	DRWTK ³	EX	EX_OL	FBFL	FD
					✓		✓	✓		✓	✓	✓	✓	✓	✓	✓	✓	✓

FDSRTBTM	FLUT ⁴	FTK	ID	IH	INVFRM	IW	LIGHT	MIP	OBRB	PFINBTMB	RD	RECTK	RECTK_6	RECTKFRT6	RH	ROSFLUT	RT
	✓	✓	✓	✓	✓	✓	✓	✓	✓	✓	✓	✓	✓	✓	✓	✓	✓

RW	SBCADDY	SBCADDYSM	SCPDRW	SRT	STW	TD	TKP	TVR	UDBX	URT	VTK	WS ⁵	WTC ⁵	WTKCUP ¹	WTR
			✓	✓	✓	✓	✓	✓	✓	✓	✓	✓	✓	✓	✓

¹ Only available on 36" wide.

² Only available on 36"-48" wide.

³ Not available on 42" or 48" wide.

⁴ Not available with fluting both 6".

⁵ Only available on wide stile 3", but not available on wide stile both 3".

IH/RH availability charts starting on page G-40.
IW/RW availability charts starting on page G-46.

Base Cooking Center & Base Pantry Can Storage Cabinets

BASE COOKING CENTER with BREAD BOARD, 34 1/2" HIGH, 24" DEEP

L G I X

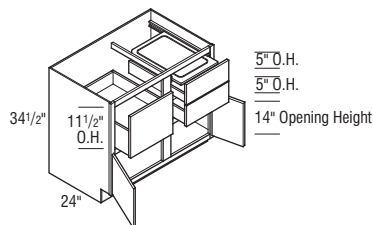

Right Shown

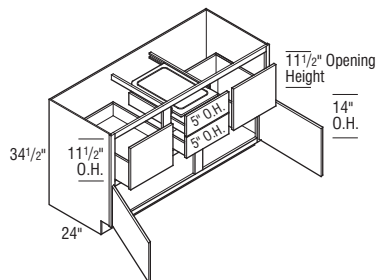

	Cubic Feet	1	2	3	4	5	6	7
BCC30BB L or R	17.4	2893	3031	3142	3317	3494	3820	4146
BCC36BB L or R	20.7	3148	3297	3421	3603	3810	4159	4508
BCC42BB L or R	24.0	3449	3620	3748	3950	4163	4549	4935
BCC48BB	27.3	3969	4157	4297	4541	4779	5231	5683

• L or R must be specified to denote Bread Board location.

Notes below apply to all products in section above:

• One cutlery divider included.

Door & Drawer Options

AF	AOMBWB	CC	CG	GAMD	IFHG	MD	PRMD	PTOWB	SHMD	SPLITDR	SPLITDRWS	TCP
		✓	✓	✓	✓	✓	✓		✓			

End Panel Options

AUTH	CSFPE	EXBK	FFD	FL/FR	FPE	INTGE	IPE
✓	✓	✓	✓	✓	✓	✓	✓

Custom Modification Options

ADD_SHLF	ADDTK	CBO	CCO	CFNTD	CFP	CFRMO	CHGDRW	CLIP	CMAT	CND	CSDGBK	DRT	DRWSEC	DRWTK ¹	EX	EX_OL	FBFL	FD
				✓		✓				✓	✓			✓	✓	✓		

FDSRTBTM	FLUT ²	FTK	ID	IH	INVFRM	IW	LIGHT	MIP	OBRB	PFINBTMB	RD	RECTK	RECTK_6	RECTKFRT6	RH	ROSLUT	RT
	✓	✓					✓	✓	✓		✓	✓	✓	✓	✓	✓	

RW	SBCADDY	SBCADDYSM	SCPDRW	SRT	STW	TD	TKP	TVR	UDBX	URT	VTK	IWS ³	WTCB	WTKCUP	WTR
							✓	✓				✓	✓		✓

¹ Not available on 42" or 48" wide.

² Not available with 6" fluting.

³ Only available on 48" wide.

BASE PANTRY CAN STORAGE, 34 1/2" HIGH, 24" DEEP

L G I X

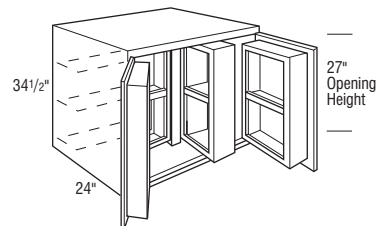

	20.7	3859	4046	4192	4427	4651	5090	5529
BPCS36								

- Six adjustable shelves behind swing-out.
- Swing-out section includes two fixed shelves.
- Unit can be used next to wall without use of a filler.
- Not available on Inset and Beaded Inset styles.

Door & Drawer Options

AF	AOMBWB	CC	CG	GAMD	IFHG	MD	PRMD	PTOWB	SHMD	SPLITDR	SPLITDRWS	TCP

End Panel Options

AUTH	CSFPE	EXBK	FFD	FL/FR	FPE	INTGE	IPE
✓	✓	✓		✓	✓	✓	✓

Custom Modification Options

ADD_SHLF	ADDTK	CBO	CCO	CFNTD	CFP	CFRMO	CHGDRW	CLIP	CMAT	CND	CSDGBK	DRT	DRWSEC	DRWTK	EX	EX_OL	FBFL	FD
															✓	✓	✓	

FDSRTBTM	FLUT ¹	FTK	ID	IH	INVFRM	IW	LIGHT	MIP	OBRB	PFINBTMB	RD	RECTK	RECTK_6	RECTKFRT6	RH	ROSLUT	RT
	✓	✓					✓	✓	✓		✓	✓	✓	✓	✓	✓	

RW	SBCADDYSM	SBCADDY	SCPDRW	SRT	STW	TD	TKP	TVR	UDBX	URT	VTK	IWS	WTCB	WTKCUP	WTR
							✓	✓				✓			✓

¹ Not available with 6" fluting.

Sink Base Cabinets

SINK BASE, 34 1/2" HIGH, 24" DEEP

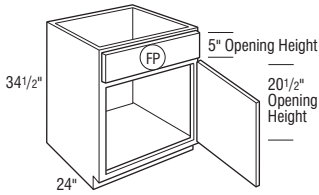

FP False Panel

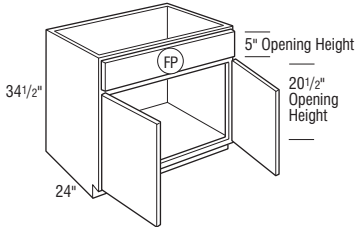

FP False Panel

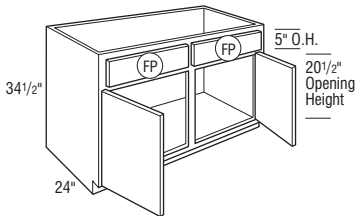

FP False Panel

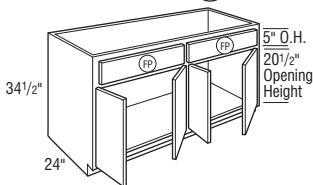

FP False Panel

	Cubic Feet	1	2	3	4	5	6	7
SB18 L or R	10.8	1110	1164	1198	1262	1320	1431	1542
SB21 L or R	12.4	1143	1196	1228	1293	1367	1476	1585
SB24 L or R	14.1	1165	1215	1261	1321	1393	1514	1635
SB24	14.1	1442	1509	1550	1630	1737	1881	2025
SB27	15.7	1556	1628	1687	1779	1853	2019	2185
SB30	17.4	1646	1721	1784	1875	1974	2149	2324
SB33	19.0	1690	1771	1832	1929	2031	2207	2383
SB36	20.7	1736	1816	1877	1977	2062	2245	2428
SB39	22.4	1760	1848	1908	2010	2118	2307	2496
SB42	24.0	1807	1888	1954	2059	2158	2351	2544
SB45	25.7	1894	1984	2052	2159	2275	2473	2671
SB48CS	27.3	1983	2074	2139	2256	2377	2585	2793
SB48	27.3	2161	2261	2332	2459	2591	2818	3045

- Two sets of butt doors.

Notes below apply to all products in section above:

- Touch-up kit (TUK) and Owner's Guide included.
- Increased Depths available in 1/4" increments from 24 1/4" to 30".
- Reduced Depths available in 1/4" increments from 6" to 23 3/4".

Door & Drawer Options

AF	AOMBWB	CC	CG	GAMD	IFHG	MD	PRMD	PTOWB	SHMD	SPLITDR ¹	SPLITDRWS ²	TCP
		✓	✓	✓	✓	✓	✓		✓	✓	✓	

End Panel Options

AUTH	CSFPE	EXBK	FFD	FL/FR	FPE	INTGE	IPE
✓	✓	✓	✓	✓	✓	✓	✓

Custom Modification Options

ADD	SHLF	ADTK	CBO	CCO ³	CFNT0	CFP	CFRMO	CHGDRW	CLIP	CMAT ⁴	CND	CSDGBK	DRT	DRWSEC	DRWTK ⁵	EX	EX_OL	FBFL	FD
		✓	✓	✓			✓		✓	✓	✓	✓			✓	✓	✓	✓	

FDSRTBTM	FLUT ⁶	FTK	ID	IH	INVERM	IW ⁷	LIGHT	MIP	OBRB	PFINBTMB	RD	RECTK	RECTK_6 ⁸	RECTKFR6	RH	ROSFLUT ⁹	RT
	✓	✓	✓	✓	✓	✓	✓	✓	✓	✓	✓	✓	✓	✓	✓	✓	✓

RW	SBCADDY	SBCADDYSM	SCPDRW	SRT	STW	TD	TKP	TVR	UDBX	URT ¹⁰	VTK	WS ¹¹	WTCD	WTKCUP	WTR
	✓	✓				✓	✓	✓	✓	✓	✓	✓	✓	✓	✓

¹ Only available on 24" (2 doors)-39" wide.

² Not available on 18", 21" or 48" wide.

³ Only available on 18"-24" (1 door) wide.

⁴ Only available on 30", 33" and 36" wide.

⁵ Only available on 24" (1 door and 2 doors), 30" and 36" wide.

⁶ Fluting both 3" not available on 24" (2 doors) wide. 6" fluting not available with 18"-21" or 24" (2 doors) wide.

⁷ 24" (1 door) and 48" wide are not available as IW.

⁸ 18" wide can only be recessed in the front, back, and/or one side only.

⁹ Fluting both not available on 24" (2 doors) wide.

¹⁰ Only available on 24" (1 door and 2 doors)-36" wide.

¹¹ Not available on 24" (2 doors) wide.

IH/RH availability charts starting on page G•40.
IW/RW availability charts starting on page G•46.

SINK BASE DOUBLE DOOR with CABMAT™, SB30CM, SB33CM, SB36CM

34 1/2" HIGH, 24" DEEP

L G I X

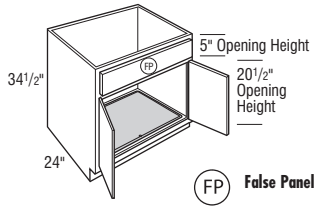

	Cubic Feet	1	2	3	4	5	6	7
SB30CM	53.6	1947	2022	2085	2176	2276	2451	2626
SB33CM	63.8	1992	2073	2133	2230	2332	2508	2684
SB36CM	70.4	2037	2117	2179	2278	2363	2546	2729

- Touch-up kit (TUK) and Owner's Guide included.
- CabMat™ is designed to capture spills and is removable for cleaning.

	Liquid Capacity		Cabinet Size	
	Gallons	Liters	Width	Depth
SB30CM	2.0	7.6	30"	24"
SB33CM	2.4	9.0	33"	24"
SB36CM	2.7	10.2	36"	24"

Door & Drawer Options

AF	AOMBWB	CC	CG	GAMD	IFHG	MD	PRMD	PTOWB	SHMD	SPLITDR	SPLITDRWS	TCP
			✓	✓	✓	✓	✓			✓	✓	

End Panel Options

AUTH	CSFPE	EXBK	FFD	FL/FR	FPE	INTGE	IPE
✓	✓	✓	✓	✓	✓	✓	✓

Custom Modification Options

ADD_SHLF	ADDTK	CBO	CCO	CFNTO	CFP	CFRMO	CHGDRW	CLIP	CMAT	CND	CSDGBK	DRT	DRWSEC	DRWTK	EX	EX_OL	FBFL	FD
											✓	✓	✓	✓	✓	✓	✓	✓

FDSRTBTM	FLUT ¹	FTK	ID	IH	INFRM	IW	LIGHT	MIP	OBRB	PFINBTMB	RD	RECTK	RECTK_6	RECTKFRT6	RH	ROSLUT	RT ²
	✓	✓	✓	✓	✓	✓	✓	✓	✓	✓	✓	✓	✓	✓	✓	✓	✓

RW	SBCADDY	SBCADDYSM	SCPDRW	SRT	STW	TD ²	TKP	TVR	UDBX	URT	VTK	WS	WTCD	WTKCUP	WTR
						✓	✓					✓	✓	✓	✓

¹ Not available with 6" fluting.

² Only available on 30" wide.

SINK BASE DOUBLE DOOR with CADDY, SB36CDY L or R

34 1/2" HIGH, 24" DEEP

L G I X

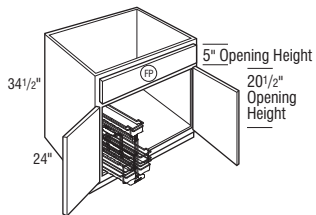

	20.7	2961	3041	3102	3202	3287	3470	3653
--	------	------	------	------	------	------	------	------

- Touch-up kit (TUK) and Owner's Guide included.
- L or R designates caddy installed side.
- Caddy includes one removable basket with handle, one basket without handle, swivel basket and 8 dividers.
- Bottom mounted full extension, Smart Stop slides.
- Caddy dimensions are 11" wide x 20" high x 18 1/2" deep.
- Caddy is removable and portable.
- Caddy also available for field installation. See page S•14.

Door & Drawer Options

AF	AOMBWB	CC	CG	GAMD	IFHG	MD	PRMD	PTOWB	SHMD	SPLITDR	SPLITDRWS	TCP
			✓	✓	✓	✓	✓			✓	✓	

End Panel Options

AUTH	CSFPE	EXBK	FFD	FL/FR	FPE	INTGE	IPE
✓	✓	✓	✓	✓	✓	✓	✓

Custom Modification Options

ADD_SHLF	ADDTK	CBO	CCO	CFNTO	CFP	CFRMO	CHGDRW	CLIP	CMAT	CND	CSDGBK	DRT	DRWSEC	DRWTK	EX	EX_OL	FBFL	FD
											✓	✓	✓	✓	✓	✓	✓	✓

FDSRTBTM	FLUT	FTK	ID	IH	INFRM	IW	LIGHT	MIP	OBRB	PFINBTMB	RD	RECTK	RECTK_6	RECTKFRT6	RH	ROSLUT	RT
	✓	✓	✓	✓	✓	✓	✓	✓	✓	✓	✓	✓	✓	✓	✓	✓	✓

RW	SBCADDY	SBCADDYSM	SCPDRW	SRT	STW	TD	TKP	TVR	UDBX	URT	VTK	WS	WTCD	WTKCUP	WTR
						✓	✓	✓				✓	✓	✓	✓

Sink Base Cabinets

SINK BASE with TILT-OUT TRAY, 34 1/2" HIGH, 24" DEEP

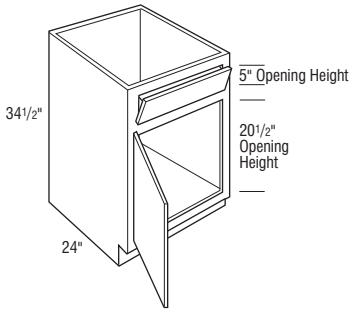

	Cubic Feet	1	2	3	4	5	6	7
SB18ST L or R	10.8	1179	1233	1279	1338	1407	1529	1651
SB21ST L or R	12.4	1213	1270	1310	1379	1442	1568	1694
SB24ST L or R	14.1	1241	1297	1341	1409	1491	1614	1737

- Touch-up kit (TUK) and Owner's Guide included.
- Increased Depths available in 1/4" increments from 24 1/4" to 30".
- Reduced Depths available in 1/4" increments from 6" to 23 3/4".
- One drawer front with one 1 11/16" deep stainless steel Tilt-out Tray attached.

Door & Drawer Options

AF	AOMBWB	CC	CG	GAMD	IFHG	MD	PRMD	PTOWB	SHMD	SPLITDR	SPLITDRWS ¹	TCP
		✓	✓	✓	✓	✓			✓		✓	

End Panel Options

AUTH	CSFPE	EXBK	FFD	FL/FR	FPE	INTGE	IPE
✓	✓	✓	✓	✓	✓	✓	✓

Custom Modification Options

ADD_SHLF	ADDTK	CBO	CCO	CFNTD	CFP	CFRMO	CHGDRW	CLIP	CMAT	CND	CSDGBK	DRT	DRWSEC	DRWTK ¹	EX	EX_OL	FBFL	FD
		✓	✓	✓		✓		✓		✓	✓			✓	✓	✓		

FDSRTBTM	FLUT ²	FTK	ID	IH	INVFRM	IW	LIGHT	MIP	OBRB	PFINBTMB	RD	RECTK	RECTK_6 ³	RECTKFR6	RH	ROSLUT	RT
	✓	✓	✓	✓				✓	✓		✓	✓	✓	✓	✓	✓	✓

RW	SBCADDY	SBCADDYSM	SCPDRW	SRT	STW	TD	TKP	TVR	UDBX	URT ¹	VTK	WS	WTCB	WTKCUP	WTR
✓							✓	✓	✓		✓	✓	✓		✓

¹ Only available on 24" wide.

² 6" fluting not available on 18" or 21" wide.

³ 18" wide can only be recessed in the front, back, and/or one side only.

IH/RH availability charts starting on page G•40.
IW/RW availability charts starting on page G•46.

SINK BASE with TILT-OUT TRAY, 34 1/2" HIGH, 24" DEEP

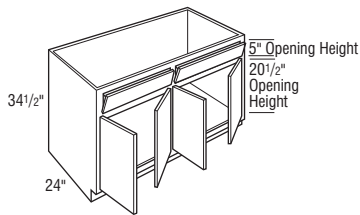
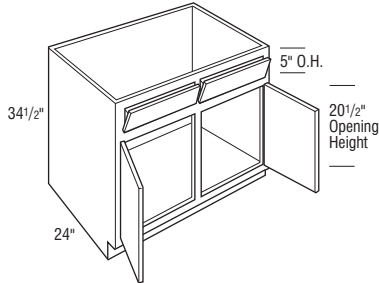
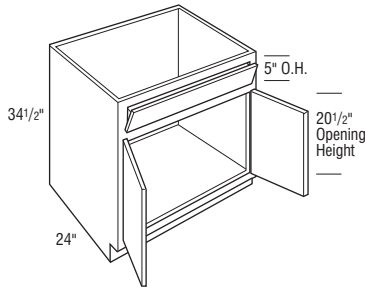

	Cubic Feet	1	2	3	4	5	6	7
SB24ST	14.1	1529	1600	1637	1725	1826	1986	2146
SB27ST	15.7	1609	1679	1741	1829	1922	2090	2258
SB30ST	17.4	1794	1876	1940	2038	2150	2339	2528
SB33ST	19.0	1834	1922	1983	2086	2197	2389	2581
SB36ST	20.7	1886	1974	2035	2139	2255	2458	2661
SB39ST	22.4	1914	2000	2074	2186	2304	2514	2724
<ul style="list-style-type: none"> • One drawer front with one 1 11/16" deep stainless steel Tilt-out Tray attached. 								
SB42ST	24.0	1945	2037	2109	2223	2357	2574	2791
SB45ST	25.7	2045	2139	2218	2337	2478	2704	2930
SB48CSST	27.3	2111	2214	2291	2417	2559	2795	3031
<ul style="list-style-type: none"> • Two drawer fronts with two 1 11/16" deep stainless steel Tilt-out Trays attached. 								
SB48ST	27.3	2259	2369	2451	2586	2738	2991	3244

- Two sets of butt doors.
- Two drawer fronts with two 1 11/16" deep stainless steel Tilt-out Trays attached.

Notes below apply to all products in section above:

- Touch-up kit (TUK) and Owner's Guide included.
- Increased Depths available in 1/4" increments from 24 1/4" to 30".
- Reduced Depths available in 1/4" increments from 6" to 23 3/4".

Door & Drawer Options

AF	AOMBWB	CC	CG	GAMD	IFHG	MD	PRMD ¹	PTOWB	SHMD	SPLITDR ²	SPLITDRWS ³	TCP
			✓	✓	✓	✓	✓		✓	✓	✓	

End Panel Options

AUTH	CSFPE	EXBK	FFD	FL/FR	FPE	INTGE	IPE
✓	✓	✓	✓	✓	✓	✓	✓

Custom Modification Options

ADD_SHLF	ADDTK	CBO	CCO	CFNTO	CFP	CFRMO	CHGDRW	CLIP ⁴	CMAT ⁵	CND	CSDGBK	DRT	DRWSEC	DRWTK ⁶	EX	EX_OL	FBFL	FD
				✓	✓	✓		✓	✓	✓	✓		✓	✓	✓	✓	✓	

FDSRTBTM	FLUT ⁷	FTK	ID	IH	INVFRM	IW	LIGHT	MIP	OBRB	PFINBTMB	RD	RECTK	RECTK_6	RECTKFRT ⁶	RH	ROSFLUT	RT
	✓	✓	✓	✓				✓	✓		✓	✓	✓	✓	✓	✓	✓

RW	SBCADDY	SBCADDYSM	SCPDRW	SRT	STW	TD	TKP	TVR	UDBX	URT ⁸	VTK	WS ¹	WTCDD	WTKCUP	WTR
	✓							✓	✓	✓	✓	✓			✓

¹ Not available on 24" wide.
² Not available on 42"-48" wide.
³ Not available on 24" or 48" wide.
⁴ Not available on 24" wide.
⁵ Only available on 30"-36" wide.
⁶ Only available on 24", 30" and 36" wide.
⁷ 6" fluting not available on 24" wide.
⁸ Not available on 39"-48" wide.

Sink Base Cabinets

SINK BASE with TILT-OUT TRAY and CADDY, 34 1/2" HIGH, 24" DEEP L O G I X

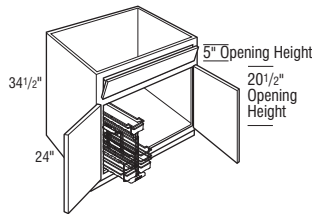

Cubic Feet	1	2	3	4	5	6	7	
SB36STCDY L or R	20.7	3111	3199	3260	3364	3480	3683	3886

- One drawer front with one 1 11/16" deep stainless steel Tilt-out Tray attached.
- Touch-up kit (TUK) and Owner's Guide included.
- L or R designates caddy installed side.
- Caddy includes one removable basket with handle, one basket without handle, swivel basket and 8 dividers.
- Bottom mounted full extension, Smart Stop slides.
- Caddy dimensions are 11" wide x 20" high x 18 1/2" deep.
- Caddy is removable and portable.
- Caddy also available for field installation. See page S•14.

Door & Drawer Options

AF	AOMBWB	CC	CG	GAMD	IFHG	MD	PRMD	PTOWB	SHMD	SPLITDR	SPLITDRWS	TCP
		✓	✓	✓	✓	✓	✓			✓	✓	✓

End Panel Options

AUTH	CSFPE	EXBK	FFD	FL/FR	FPE	INTGE	IPE
✓	✓	✓	✓	✓	✓	✓	✓

Custom Modification Options

ADD_SHLF	ADDTK	CBO	CCO	CFNTD	CFP	CFRMO	CHGDRW	CLIP	CMAT	CND	CSDGBK	DRT	DRWSEC	DRWTK	EX	EX_OL	FBFL	FD	
		✓	✓	✓	✓	✓	✓	✓	✓	✓	✓	✓	✓	✓	✓	✓	✓	✓	✓
FDSRTBTM	FLUT	FTK	ID	IH	INVERM	IW	LIGHT	MIP	OBRB	PFINBTMB	RD	RECTK	RECTK_6	RECTKFR6	RH	ROSFLUT	RT		
✓	✓	✓	✓	✓	✓	✓	✓	✓	✓	✓	✓	✓	✓	✓	✓	✓	✓	✓	
RW	SBCADDY	SBCADDYSM	SCPDRW	SRT	STW	TD	TKP	TVR	UDBX	URT	VTK	WS	WTCO	WTKCUP	WTR				
						✓	✓	✓	✓	✓	✓	✓	✓	✓	✓				

SINK BASE with TILT-OUT TRAYS and CABMAT™, 34 1/2" HIGH, 24" DEEP L O G I X

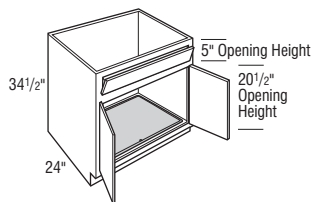

SB30STCM	53.6	2095	2177	2241	2340	2452	2640	2828
SB33STCM	63.8	2136	2223	2284	2388	2498	2690	2882
SB36STCM	70.4	2187	2276	2336	2441	2556	2759	2962

- Touch-up kit (TUK) and Owner's Guide included.
- CabMat™ is designed to capture spills and is removable for cleaning.
- One drawer front with one 1 11/16" deep stainless steel Tilt-out Tray attached.

	Liquid Capacity		Cabinet Size	
	Gallons	Liters	Width	Depth
SB30STCM	2.0	7.6	30"	24"
SB33STCM	2.4	9.0	33"	24"
SB36STCM	2.7	10.2	36"	24"

Door & Drawer Options

AF	AOMBWB	CC	CG	GAMD	IFHG	MD	PRMD	PTOWB	SHMD	SPLITDR	SPLITDRWS	TCP
		✓	✓	✓	✓	✓	✓			✓	✓	✓

End Panel Options

AUTH	CSFPE	EXBK	FFD	FL/FR	FPE	INTGE	IPE
✓	✓	✓	✓	✓	✓	✓	✓

Custom Modification Options

ADD_SHLF	ADDTK	CBO	CCO	CFNTD	CFP	CFRMO	CHGDRW	CLIP	CMAT	CND	CSDGBK	DRT	DRWSEC	DRWTK	EX	EX_OL	FBFL	FD	
		✓	✓	✓	✓	✓	✓	✓	✓	✓	✓	✓	✓	✓	✓	✓	✓	✓	✓
FDSRTBTM	FLUT ¹	FTK	ID	IH	INVERM	IW	LIGHT	MIP	OBRB	PFINBTMB	RD	RECTK	RECTK_6	RECTKFR6	RH	ROSFLUT	RT ²		
✓	✓	✓	✓	✓	✓	✓	✓	✓	✓	✓	✓	✓	✓	✓	✓	✓	✓	✓	
RW	SBCADDY	SBCADDYSM	SCPDRW	SRT	STW	TD ²	TKP	TVR	UDBX	URT	VTK	WS	WTCO	WTKCUP	WTR				
						✓	✓	✓	✓	✓	✓	✓	✓	✓	✓				

¹ Not available with 6" fluting.

² Only available on 30" wide.

IH/RH availability charts starting on page G•40.
IW/RW availability charts starting on page G•46.

Sink Base Cabinets

SINK BASE, 34 1/2" HIGH, 27" DEEP

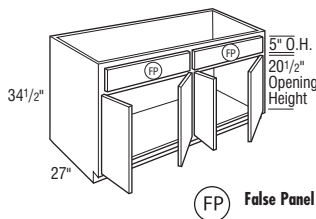
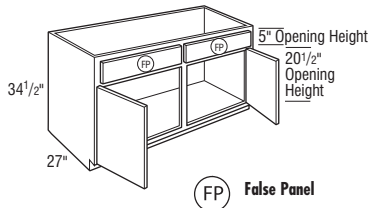
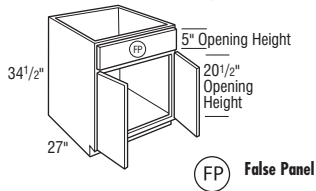
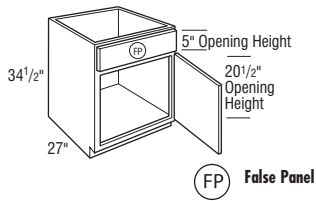

	Cubic Feet	1	2	3	4	5	6	7
SB243427 L or R	15.1	1165	1215	1261	1321	1393	1514	1635
SB243427	15.1	1442	1509	1550	1630	1737	1881	2025
SB273427	16.9	1556	1628	1687	1779	1853	2019	2185
SB303427	18.7	1646	1721	1784	1875	1974	2149	2324
SB333427	20.5	1690	1771	1832	1929	2031	2207	2383
SB363427	22.3	1736	1816	1877	1977	2062	2245	2428
SB393427	24.1	1760	1848	1908	2010	2118	2307	2496
SB423427	25.9	1807	1888	1954	2059	2158	2351	2544
SB453427	27.7	1894	1984	2052	2159	2275	2473	2671
SB483427CS	29.5	1983	2074	2139	2256	2377	2585	2793
SB483427	29.5	2181	2281	2353	2482	2615	2844	3073

• Two sets of butt doors.

Notes below apply to all products in section above:

- Touch-up kit (TUK) and Owner's Guide included.
- Increased Depths available in 1/4" increments from 27 1/4" to 30".
- Reduced Depths available in 1/4" increments from 6" to 26 3/4".

Door & Drawer Options

AF	AOMBWB	CC	CG	GAMD	IFHG	MD	PRMD	PTOWB	SHMD	SPLITDR ¹	SPLITDRWS ²	TCP
			✓		✓	✓	✓			✓	✓	

End Panel Options

AUTH	CSFPE	EXBK	FFD	FL/FR	FPE	INTGE	IPE
✓	✓	✓	✓	✓	✓	✓	✓

Custom Modification Options

ADD	SHLF	ADDTK	CBO	CCO ³	CFNT0	CFP	CFRMO	CHGDRW	CLIP	CMAT	CND	CSDGBK	DRT	DRWSEC	DRWTK ⁴	EX	EX_OL	FBFL	FD
			✓	✓		✓	✓		✓		✓	✓			✓	✓	✓	✓	
FDSRTBTM	FLUT ⁵	FTK	ID	IH	INVFRM	IW ²	LIGHT	MIP	OBRB	PFINBTMB	RD	RECTK	RECTK_6 ⁶	RECTKFRT6	RH	ROSLUT ⁷	RT		
	✓	✓	✓	✓		✓		✓	✓		✓	✓	✓	✓	✓	✓	✓		
RW	SBCADDY	SBCADDYSM	SCPDRW	SRT	STW	TD	TKP	TVR	UDBX	URT	VTK	WS ⁸	WTCD	WTKCUP	WTR				
	✓	✓					✓	✓	✓		✓	✓			✓				

¹ Not available on 42"-48" wide.

² Not available on 48" wide.

³ Not available on 24" (1 door) wide.

⁴ Not available on 24" (1 door) or 39"-48" wide.

⁵ 6" fluting and FLUT3B not available on 24" wide.

⁶ Not available on SB483427.

⁷ ROSFLUT3B not available on 24" wide.

⁸ Not available on 24" wide.

Sink Base Cabinets

SINK BASE with TILT-OUT TRAY, 34 1/2" HIGH, 27" DEEP

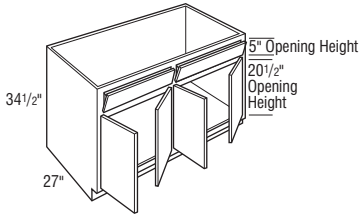
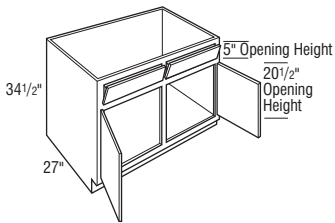
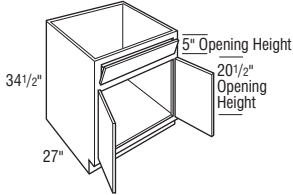
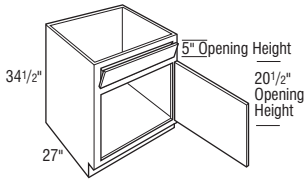

	Cubic Feet	1	2	3	4	5	6	7
SB243427ST L or R	15.1	1241	1297	1341	1409	1491	1614	1737
• One drawer front with one 1 11/16" deep stainless steel Tilt-out Tray attached.								
SB243427ST	15.1	1529	1600	1637	1725	1826	1986	2146
SB273427ST	16.9	1609	1679	1741	1829	1922	2090	2258
SB303427ST	18.7	1794	1876	1940	2038	2150	2339	2528
SB333427ST	20.5	1834	1922	1983	2086	2197	2389	2581
SB363427ST	22.3	1886	1974	2035	2139	2255	2458	2661
SB393427ST	24.1	1914	2000	2074	2186	2304	2514	2724
• One drawer front with one 1 11/16" deep stainless steel Tilt-out Tray attached.								
SB423427ST	25.9	1945	2037	2109	2223	2357	2574	2791
SB453427ST	27.7	2045	2139	2218	2337	2478	2704	2930
SB483427CSST	29.5	2111	2214	2291	2417	2559	2795	3031
• Two drawer fronts with two 1 11/16" deep stainless steel Tilt-out Trays attached.								
SB483427ST	29.5	2322	2435	2520	2659	2815	3075	3335

- Two sets of butt doors.
- Two drawer fronts with two 1 11/16" deep stainless steel Tilt-out Trays attached.

Notes below apply to all products in section above:

- Touch-up kit (TUK) and Owner's Guide included.
- Increased Depths available in 1/4" increments from 27 1/4" to 30".
- Reduced Depths available in 1/4" increments from 6" to 26 3/4".

Door & Drawer Options

AF	AOMBWB	CC	CG	GAMD	IFHG	MD	PRMD	PTOWB	SHMD	SPLITDR ¹	SPLITDRWS ²	TCP
			✓		✓	✓	✓			✓	✓	

End Panel Options

AUTH	CSFPE	EXBK	FFD	FL/FR	FPE	INTGE	IPE
✓	✓	✓	✓		✓	✓	✓

Custom Modification Options

ADD	SHLF	ADDTK	CBO	CCO ³	CFNT0	CFP	CFRMO	CHGDRW	CLIP ⁴	CMAT	CND	CSDGBK	DRT	DRWSEC	DRWTK ⁵	EX	EX_OL	FBFL	FD
			✓	✓	✓		✓		✓		✓	✓	✓		✓	✓	✓		

FDSRTBTM	FLUT ⁶	FTK	ID	IH	INVRM	IW	LIGHT	MIP	OBRB	PFINBTMB	RD	RECTK	RECTK_6 ⁷	RECTKFR6	RH	ROSLUT	RT
	✓	✓	✓	✓			✓	✓	✓		✓	✓	✓	✓	✓	✓	✓

RW	SBCADDY	SBCADDYSM	SCPDRW	SRT	STW	TD	TKP	TVR	UDBX	URT	VTK	WS ⁴	WTCB	WTKCUP	WTR
	✓	✓					✓	✓	✓		✓	✓			✓

¹ Not available on 24" (1 door) or 42"-48" wide.

² Not available on 24" (2 doors) or 48" wide.

³ Only available on 24" (1 door) wide.

⁴ Not available on 24" (2 doors) wide.

⁵ Not available on 39"-48" wide.

⁶ 6" fluting not available with 30"-39" wide.

⁷ Only available on 30"-48" wide.

IH/RH availability charts starting on page G-40.
IW/RW availability charts starting on page G-46.

SINK BASE SUPERCABINET™, 34 1/2" HIGH, 24" DEEP

L G I X

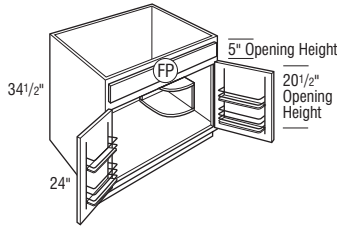

FP False Panel

	Cubic Feet	1	2	3	4	5	6	7
SB305	17.4	2454	2527	2590	2685	2781	2956	3131
SB335	19.0	2501	2576	2642	2735	2837	3010	3183
SB365	20.7	2542	2624	2688	2785	2868	3053	3238

- Quarter Round Reversible Shelf for left or right applications included except when selected with the CabMat™ modification.
- Basket size on 30" and 33" door is 11 1/2" W x 20 1/2" H x 3 1/2" D.
- Basket size on 36" door is 14 1/2" W x 20 1/2" H x 3 1/2" D.
- Touch-up kit (TUK) and Owner's Guide included.
- Door includes a two-tiered non-adjustable chrome rack with wood bottoms.
- Increased Depths available in 1/4" increments from 24 1/4" to 30".
- Not available on Inset and Beaded Inset styles.

Door & Drawer Options

AF	AOMBWB	CC	CG	GAMD	IFHG	MD	PRMD	PTOWB	SHMD	SPLITDR	SPLITDRWS	TCP
												✓

End Panel Options

AUTH	CSFPE	EXBK	FFD	FL/FR	FPE	INTGE	IPE
✓	✓	✓	✓	✓	✓	✓	✓

Custom Modification Options

ADD_SHLF	ADDTK	CBO	CCO	CFNTO	CFP	CFRMO	CHGDRW	CLIP ¹	CMAT	CND	CSDGBK	DRT	DRWSEC	DRWTK ²	EX	EX_OL	FBFL	FD	
								✓	✓	✓	✓	✓	✓	✓	✓	✓	✓	✓	✓

FDSRTBTM	FLUT ³	FTK	ID	IH ²	INVFRM	IW	LIGHT	MIP	OBRB	PFINBTMB	RD	RECTK	RECTK_6	RECTKFR6	RH ⁴	ROSLUT	RT
	✓	✓	✓	✓				✓	✓		✓	✓	✓	✓	✓	✓	✓

RW	SBCADDY	SBCADDYSM	SCPDRW	SRT	STW	TD	TKP	TVR	UDBX	URT	VTK	WS ⁵	WTC	WTKCUP	WTR
								✓	✓		✓	✓			✓

- ¹ Not available on 30" wide.
² Not available on 33" wide.
³ 6" fluting not available on 30" wide.
⁴ Only available on 30" wide.
⁵ Not available on 30" wide. Not available on wide stile 1.5" except wide stile both 1.5".

SINK BASE SUPERCABINET™ with CADDY, 34 1/2" HIGH, 24" DEEP

L G I X

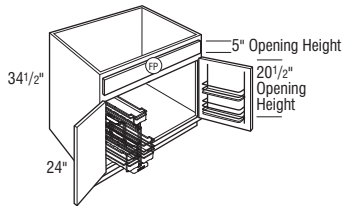

	Cubic Feet	1	2	3	4	5	6	7
SB365CDY L or R	20.7	3767	3849	3913	4010	4093	4278	4463

- Touch-up kit (TUK) and Owner's Guide included.
- L or R designates caddy installed side.
- Caddy includes one removable basket with handle, one basket without handle, swivel basket and 8 dividers.
- Bottom mounted full extension, Smart Stop slides.
- Caddy dimensions are 11" wide x 20" high x 18 1/2" deep.
- Caddy is removable and portable.
- Caddy also available for field installation. See page S-14.
- Door without caddy features a two-tiered non-adjustable chrome rack with wood bottoms.
- Basket size on door is 14 1/2" W x 20 1/2" H x 3 1/2" D.
- Not available on Inset and Beaded Inset styles.

Door & Drawer Options

AF	AOMBWB	CC	CG	GAMD	IFHG	MD	PRMD	PTOWB	SHMD	SPLITDR	SPLITDRWS	TCP
												✓

End Panel Options

AUTH	CSFPE	EXBK	FFD	FL/FR	FPE	INTGE	IPE
✓	✓	✓	✓	✓	✓	✓	✓

Custom Modification Options

ADD_SHLF	ADDTK	CBO	CCO	CFNTO	CFP	CFRMO	CHGDRW	CLIP	CMAT	CND	CSDGBK	DRT	DRWSEC	DRWTK	EX	EX_OL	FBFL	FD	
								✓	✓	✓	✓	✓	✓	✓	✓	✓	✓	✓	✓

FDSRTBTM	FLUT	FTK	ID	IH	INVFRM	IW	LIGHT	MIP	OBRB	PFINBTMB	RD	RECTK	RECTK_6	RECTKFR6	RH	ROSLUT	RT
	✓	✓	✓	✓				✓	✓		✓	✓	✓	✓	✓	✓	✓

RW	SBCADDY	SBCADDYSM	SCPDRW	SRT	STW	TD	TKP	TVR	UDBX	URT	VTK	WS	WTC	WTKCUP	WTR
								✓	✓		✓	✓			✓

Sink Base Supercabinets™

SINK BASE SUPERCABINET™ with CABMAT™, 34 1/2" HIGH, 24" DEEP

L O G I X

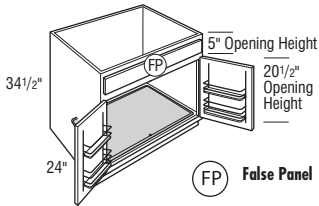

	Cubic Feet	1	2	3	4	5	6	7
SB30SCM	53.6	2756	2828	2891	2987	3083	3258	3433
SB33SCM	63.8	2802	2877	2944	3036	3138	3312	3486
SB36SCM	70.4	2843	2925	2989	3087	3169	3355	3541

- Both doors will have a chrome and wood two-tiered rack.
- Basket size on 30" and 33" door is 11 1/2" W x 20 1/2" H x 3 1/2" D.
- Basket size on 36" door is 14 1/2" W x 20 1/2" H x 3 1/2" D.
- CabMat™ is designed to capture spills and is removable for cleaning.
- Touch-up kit (TUK) and Owner's Guide included.
- Not available on Inset and Beaded Inset styles.

	Liquid Capacity		Cabinet Size	
	Gallons	Liters	Width	Depth
SB30SCM	2.0	7.6	30"	24"
SB33SCM	2.4	9.0	33"	24"
SB36SCM	2.7	10.2	36"	24"

Door & Drawer Options

AF	AOMBWB	CC	CG	GAMD	IFHG	MD	PRMD	PTOWB	SHMD	SPLITDR	SPLITDRWS	TCP
----	--------	----	----	------	------	----	------	-------	------	---------	-----------	-----

End Panel Options

AUTH	CSFPE	EXBK	FFD	FL/FR	FPE	INTGE	IPE
------	-------	------	-----	-------	-----	-------	-----

Custom Modification Options

ADD	SHLF	ADDTK	CBO	CCO	CFNTO	CFP	CFRMO	CHGDRW	CLIP	CMAT	CND	CSDGBK	DRT	DRWSEC	DRWTK	EX	EX_OL	FBFL	FD
-----	------	-------	-----	-----	-------	-----	-------	--------	------	------	-----	--------	-----	--------	-------	----	-------	------	----

FDSRTBTM	FLUT ¹	FTK	ID	IH	INVFRM	IW	LIGHT	MIP	OBRB	PFINBTMB	RD	RECTK	RECTK_6	RECTKFR6	RH ²	ROSFLUT	RW
----------	-------------------	-----	----	----	--------	----	-------	-----	------	----------	----	-------	---------	----------	-----------------	---------	----

RW	SBCADDY	SBCADDYSM	SCPDWR	SRT	STW	TD	TKP	TVR	UBX	URT	VTK	WS	WTCO	WTKCUP	WTR
----	---------	-----------	--------	-----	-----	----	-----	-----	-----	-----	-----	----	------	--------	-----

¹ Not available with 6" fluting.

² Only available on 30" wide.

SINK BASE SUPERCABINET™ with TILT-OUT TRAY, 34 1/2" HIGH, 24" DEEP

L O G I X

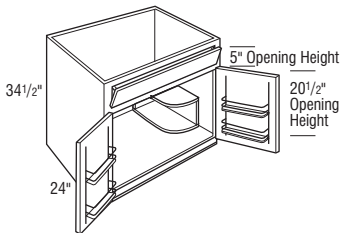

	17.4	2599	2687	2747	2845	2957	3147	3337
SB30STS								
SB33STS	19.0	2644	2727	2790	2896	3004	3197	3390
SB36STS	20.7	2695	2781	2842	2948	3062	3262	3462

- Quarter Round Reversible Shelf for left or right applications included except when selected with the CabMat™ modification.
- Basket size on 36" door is 14 1/2" W x 20 1/2" H x 3 1/2" D.
- Basket size on 30" and 33" door is 11 1/2" W x 20 1/2" H x 3 1/2" D.
- Touch-up kit (TUK) and Owner's Guide included.
- Door includes a two-tiered non-adjustable chrome rack with wood bottoms.
- Increased Depths available in 1/4" increments from 24 1/4" to 30".
- Not available on Inset and Beaded Inset styles.
- One drawer front with one 1 11/16" deep stainless steel Tilt-out Tray attached.

Door & Drawer Options

AF	AOMBWB	CC	CG	GAMD	IFHG	MD	PRMD	PTOWB	SHMD	SPLITDR	SPLITDRWS	TCP
----	--------	----	----	------	------	----	------	-------	------	---------	-----------	-----

End Panel Options

AUTH	CSFPE	EXBK	FFD	FL/FR	FPE	INTGE	IPE
------	-------	------	-----	-------	-----	-------	-----

Custom Modification Options

ADD	SHLF	ADDTK	CBO	CCO	CFNTO	CFP	CFRMO	CHGDRW	CLIP ¹	CMAT	CND	CSDGBK	DRT	DRWSEC	DRWTK ²	EX	EX_OL	FBFL	FD
-----	------	-------	-----	-----	-------	-----	-------	--------	-------------------	------	-----	--------	-----	--------	--------------------	----	-------	------	----

FDSRTBTM	FLUT ³	FTK	ID	IH ²	INVFRM	IW	LIGHT	MIP	OBRB	PFINBTMB	RD	RECTK	RECTK_6	RECTKFR6	RH ⁴	ROSFLUT	RW
----------	-------------------	-----	----	-----------------	--------	----	-------	-----	------	----------	----	-------	---------	----------	-----------------	---------	----

RW	SBCADDY	SBCADDYSM	SCPDWR	SRT	STW	TD	TKP	TVR	UBX	URT	VTK	WS ⁵	WTCO	WTKCUP	WTR
----	---------	-----------	--------	-----	-----	----	-----	-----	-----	-----	-----	-----------------	------	--------	-----

¹ Not available on 30" wide.

² Not available on 33" wide.

³ 6" fluting not available on 30" or 33" wide.

⁴ Only available on 30" wide.

⁵ Not available on 30" wide. Not available on wide stile 1.5" except wide stile both 1.5".

IH/RH availability charts starting on page G-40.
IW/RW availability charts starting on page G-46.

SINK BASE SUPERCABINET™ with TILT-OUT TRAY and CADDY, 34 1/2" HIGH, 24" DEEP

L G I X

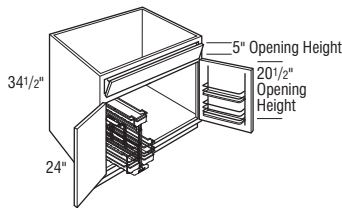

Cubic Feet	1	2	3	4	5	6	7	
SB36STSCDY L or R	20.7	3920	4006	4067	4173	4287	4487	4687

- Touch-up kit (TUK) and Owner's Guide included.
- One drawer front with one 1 11/16" deep stainless steel Tilt-out Tray attached.
- L or R designates caddy installed side.
- Caddy includes one removable basket with handle, one basket without handle, swivel basket and 8 dividers.
- Bottom mounted full extension, Smart Stop sides.
- Caddy dimensions are 11" wide x 20" high x 18 1/2" deep.
- Caddy is removable and portable.
- Caddy also available for field installation. See page S-14.
- Door without caddy features a two-tiered non-adjustable chrome rack with wood bottoms.
- Basket size on door is 14 1/2" W x 20 1/2" H x 3 1/2" D.
- Not available on Inset and Beaded Inset styles.

Door & Drawer Options

AF	AOMBWB	CC	CG	GAMD	IFHG	MD	PRMD	PTOWB	SHMD	SPLITDR	SPLITDRWS	TCP
----	--------	----	----	------	------	----	------	-------	------	---------	-----------	-----

End Panel Options

AUTH	CSFPE	EXBK	FFD	FL/FR	FPE	INTGE	IPE
✓	✓	✓	✓	✓	✓	✓	✓

Custom Modification Options

ADD_SHLF	ADDTK	CBO	CCO	CFNTO	CFP	CFRMO	CHGDRW	CLIP	CMAT	CND	CSDGBK	DRT	DRWSEC	DRWTK	EX	EX_OL	FBFL	FD
								✓		✓	✓		✓	✓	✓	✓		

FDSRTBTM	FLUT ¹	FTK	ID	IH	INVFRM	IW	LIGHT	MIP	OBRB	PFINBTMB	RD	RECTK	RECTK_6	RECTKFRT6	RH	ROSFLUT	RT
	✓	✓	✓	✓				✓	✓	✓	✓	✓	✓	✓	✓	✓	✓

RW	SBCADDY	SBCADDYSM	SCPDRW	SRT	STW	TD	TKP	TVR	UDBX	URT	VTK	WS	WTCB	WTKCUP	WTR
								✓	✓		✓	✓			✓

¹ 6" fluting not available.

SINK BASE SUPERCABINET™ with TILT-OUT TRAYS and CABMAT™, 34 1/2" HIGH, 24" DEEP

L G I X

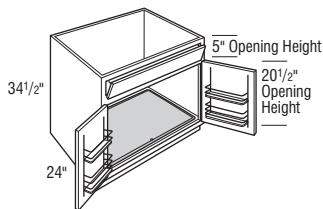

SB30STSCM	53.6	2901	2988	3048	3147	3259	3448	3637
SB33STSCM	63.8	2945	3029	3091	3197	3305	3499	3693
SB36STSCM	70.4	2997	3083	3143	3249	3363	3564	3765

- Both doors will have a chrome and wood two-tiered rack.
- Basket size on 30" and 33" door is 11 1/2" W x 20 1/2" H x 3 1/2" D.
- Basket size on 36" door is 14 1/2" W x 20 1/2" H x 3 1/2" D.
- CabMat™ is designed to capture spills and is removable for cleaning.
- Touch-up kit (TUK) and Owner's Guide included.
- One drawer front with one 1 11/16" deep stainless steel Tilt-out Tray attached.
- Not available on Inset and Beaded Inset styles.

	Liquid Capacity		Cabinet Size	
	Gallons	Liters	Width	Depth
SB30STSCM	2.0	7.6	30"	24"
SB33STSCM	2.4	9.0	33"	24"
SB36STSCM	2.7	10.2	36"	24"

Door & Drawer Options

AF	AOMBWB	CC	CG	GAMD	IFHG	MD	PRMD	PTOWB	SHMD	SPLITDR	SPLITDRWS	TCP
----	--------	----	----	------	------	----	------	-------	------	---------	-----------	-----

End Panel Options

AUTH	CSFPE	EXBK	FFD	FL/FR	FPE	INTGE	IPE
✓	✓	✓	✓	✓	✓	✓	✓

Custom Modification Options

ADD_SHLF	ADDTK	CBO	CCO	CFNTO	CFP	CFRMO	CHGDRW	CLIP	CMAT	CND	CSDGBK	DRT	DRWSEC	DRWTK	EX	EX_OL	FBFL	FD
										✓	✓		✓	✓	✓	✓		

FDSRTBTM	FLUT ¹	FTK	ID	IH	INVFRM	IW	LIGHT	MIP	OBRB	PFINBTMB	RD	RECTK	RECTK_6	RECTKFRT6	RH	ROSFLUT	RT
	✓	✓	✓	✓				✓	✓	✓	✓	✓	✓	✓	✓	✓	✓

RW	SBCADDY	SBCADDYSM	SCPDRW	SRT	STW	TD	TKP	TVR	UDBX	URT	VTK	WS	WTCB	WTKCUP	WTR
								✓	✓		✓	✓			✓

¹ Not available with 6" fluting.

Country Sink Base Cabinets

COUNTRY SINK BASE CABINET, 34 1/2" HIGH, 24" DEEP

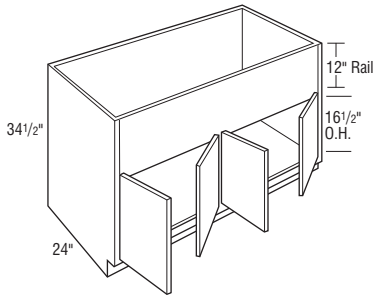
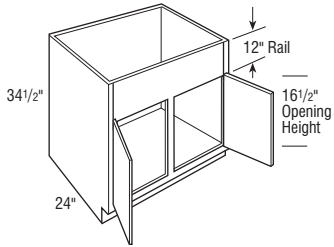
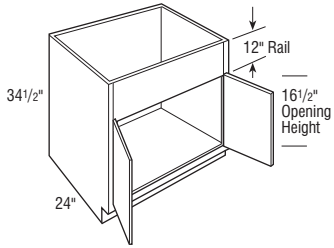

	Cubic Feet	1	2	3	4	5	6	7
CNTYSB30	17.4	2049	2118	2182	2271	2379	2553	2727
CNTYSB33	19.0	2107	2176	2239	2331	2438	2617	2796
CNTYSB36	20.7	2165	2238	2303	2399	2500	2681	2862
CNTYSB39	22.4	2252	2326	2389	2492	2598	2788	2978
CNTYSB42	24.0	2272	2341	2412	2516	2619	2808	2997
CNTYSB45	25.7	2464	2545	2618	2726	2842	3047	3252
CNTYSB48CS	27.3	2486	2571	2646	2756	2869	3080	3291
CNTYSB48	27.3	2735	2828	2911	3032	3156	3388	3620

- Two sets of butt doors.

Notes below apply to all products in section above:

- Top rail can be trimmed up to 10 1/2".
- Touch-up kit (TUK) and Owner's Guide Included.
- Increased Depths available in 1/4" increments from 24 1/4" to 30".
- Reduced Depths available in 1/4" increments from 6" to 23 3/4".

Door & Drawer Options

AF	AOMBWB	CC	CG	GAMD	IFHG	MD	PRMD	PTOWB	SHMD	SPLITDR ¹	SPLITDRWS	TCP
			✓	✓	✓	✓	✓		✓	✓		

End Panel Options

AUTH	CSFPE	EXBK	FFD	FL/FR	FPE	INTGE	IPE
✓	✓	✓		✓	✓	✓	✓

Custom Modification Options

ADD	SHLF	ADDTK	CBO	CCO	CFNTO	CFP	CFRMO	CHGDRW	CLIP	CMAT ²	CND	CSDGBK	DRT	DRWSEC	DRWTK ³	EX	EX_OL	FBFL	FD
			✓		✓		✓		✓	✓	✓	✓			✓	✓	✓		

FDSRTBTM	FLUT	FTK	ID	IH	INFRM	IW ⁴	LIGHT	MIP	OBRB	PFINBTMB	RD	RECTK	RECTK_6	RECTKFR16	RH	ROSFLUT	RT ⁵
✓	✓	✓	✓		✓		✓	✓	✓		✓	✓	✓	✓	✓	✓	✓

RW	SBCADDY	SBCADDYSM	SCPDRW	SRT	STW	TD	TKP	TVR	UDBX	URT ²	VTK	WS	WTCB	WTKCUP	WTR
✓		✓					✓	✓		✓	✓	✓			

¹ Not available on 42"-48" wide.

² Not available on 39"-48" wide.

³ Only available on 30" and 36" wide.

⁴ Not available on 48" wide.

⁵ Not available on 45" wide.

IH/RH availability charts starting on page G-40.
IW/RW availability charts starting on page G-46.

Country Sink Base Cabinets

COUNTRY SINK BASE with CABMAT™, 34 1/2" HIGH, 24" DEEP

L G I X

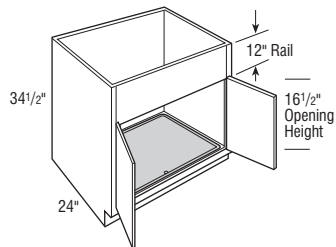

	Cubic Feet	1	2	3	4	5	6	7
CNTYSB30CM	53.6	2351	2420	2484	2572	2681	2854	3027
CNTYSB33CM	63.8	2409	2478	2540	2633	2740	2918	3096
CNTYSB36CM	70.4	2467	2539	2604	2700	2801	2982	3163

- 12" top rail can be trimmed up to 10 1/2".
- Touch-up kit (TUK) and Owner's Guide included.
- CabMat™ is designed to capture spills and is removable for cleaning.

	Liquid Capacity		Cabinet Size	
	Gallons	Liters	Width	Depth
CNTYSB30CM	2.0	7.6	30"	24"
CNTYSB33CM	2.4	9.0	33"	24"
CNTYSB36CM	2.7	10.2	36"	24"

Door & Drawer Options

AF	AOMBWB	CC	CG	GAMD	IFHG	MD	PRMD	PTOWB	SHMD	SPLITDR	SPLITDRWS	TCP
			✓	✓	✓	✓	✓		✓	✓		

End Panel Options

AUTH	CSFPE	EXBK	FFD	FL/FR	FPE	INTGE	IPE
✓	✓	✓		✓	✓	✓	✓

Custom Modification Options

ADD_SHLF	ADDTK	CBO	CCO	CFNTO	CFP	CFRMO	CHGDRW	CLIP	CMAT	CND	CSDGBK	DRT	DRWSEC	DRWTK	EX	EX_OL	FBFL	FD
			✓	✓	✓		✓				✓	✓		✓	✓	✓		

FDSRTBTM	FLUT ¹	FTK	ID	IH	INVFRM	IW	LIGHT	MIP	OBRB	PFINBTMB	RD	RECTK	RECTK_6	RECTKFR6	RH	ROSFLUT	RT
	✓	✓	✓	✓		✓		✓	✓			✓	✓	✓	✓	✓	

RW	SBCADDY	SBCADDYSM	SCPDRW	SRT	STW	TD	TKP	TVR	UDBX	URT	VTK	WS	WTCD	WTKCUP	WTR
								✓			✓	✓			

¹ Not available with 6" fluting.

Sink Base Cabinets with Drawer Below

SINK BASE with DRAWER BELOW, 34 1/2" HIGH, 24" DEEP

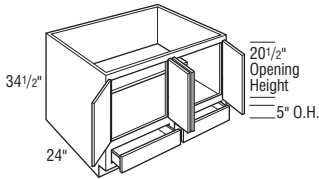
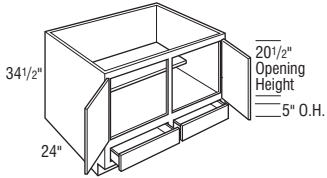
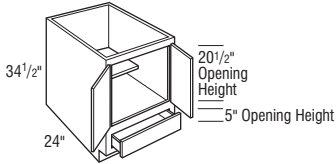
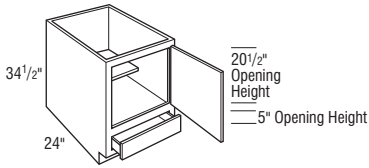

	Cubic Feet	1	2	3	4	5	6	7
SB24D L or R	14.1	1215	1272	1315	1389	1457	1586	1715
SB24D	14.1	1506	1578	1624	1712	1818	1988	2158
SB27D	15.7	1668	1752	1815	1914	2015	2206	2397
SB30D	17.4	1725	1810	1870	1977	2074	2272	2470
SB33D	19.0	1771	1858	1926	2033	2134	2331	2528
SB36D	20.7	1818	1908	1977	2086	2195	2398	2601
SB39D	22.4	1854	1946	2014	2128	2235	2439	2643
SB42D	24.0	1907	1998	2070	2187	2305	2514	2723
SB45D	25.7	2010	2109	2187	2309	2430	2656	2882
SB48DCS	27.3	2097	2197	2276	2406	2530	2765	3000
SB48D	27.3	2307	2417	2504	2647	2783	3042	3301

• Two sets of butt doors.

Notes below apply to all products in section above:

- Touch-up kit (TUK) and Owner's Guide included.
- Face frame opening height is 21".
- Face frame opening height for drawer is 4 1/2".
- One adjustable 15" deep shelf.
- Drawer is below full cabinet floor.
- Verify that sink, garbage disposal, and plumbing fit opening.
- Plumbing going through floor will interfere with drawer operation, 2 1/8" clearance from back of drawer to interior back of cabinet.

Door & Drawer Options

AF	AOMBWB	CC	CG	GAMD	IFHG	MD	PRMD	PTOWB	SHMD	SPLITDR ¹	SPLITDRWS ²	TCP
			✓			✓	✓			✓	✓	

End Panel Options

AUTH	CSFPE	EXBK	FFD	FL/FR	FPE	INTGE	IPE
✓	✓	✓	✓	✓	✓	✓	✓

Custom Modification Options

ADD	SHLF	ADDTK	CBO	CCO	CFNT0	CFP	CFRMO	CHGDRW	CLIP ³	CMAT ⁴	CND	CSDGBK	DRT	DRWSEC ⁵	DRWTK ⁶	EX	EX_OL	FBFL	FD	
			✓	✓	✓	✓	✓		✓	✓	✓	✓	✓	✓	✓	✓	✓	✓	✓	✓

FDSRTBTM	FLUT ⁷	FTK	ID	IH	INVFRM	IW ⁸	LIGHT	MIP	OBRB	PFINBTMB	RD	RECTK	RECTK_6	RECTKFRT6	RH	ROSFLUT	RT
✓	✓	✓	✓	✓	✓	✓	✓	✓	✓	✓	✓	✓	✓	✓	✓	✓	✓

RW	SBCADDY	SBCADDYSM	SCPDRW	SRT	STW	TD	TKP	TVR ⁹	UDBX ²	URT	VTK	WS ³	WTC ¹⁰	WTKCUP ¹¹	WTR
✓	✓	✓	✓	✓	✓	✓	✓	✓	✓	✓	✓	✓	✓	✓	✓

¹ Not available on 24" (1 door) or 42"-48" wide.

² Not available on 42"-48" wide.

³ Not available on 24" (2 doors) wide.

⁴ Only available on 30"-36" wide.

⁵ Only available on 24", 42" and 48" wide.

⁶ Not available on 39"-48" wide.

⁷ 6" fluting not available on 24" (2 doors) wide.

⁸ Not available on 24" or 48" wide.

⁹ Not available on 24" (2 doors) or 27" wide. TVRAV and style B-L not available on 42" or 45" wide.

¹⁰ Only available on 30" and 36" wide.

¹¹ Only available on 24" (1 door) and 36" wide.

IH/RH availability charts starting on page G-40.
IW/RW availability charts starting on page G-46.

Base Dishwasher Cabinets & Sink Fronts

BASE DISHWASHER CABINET, 40 1/2" or 46 1/2" HIGH, 24" DEEP

	Cubic Feet	1	2	3	4	5	6	7
BDW2740	18.4	1357	1422	1460	1522	1737	1890	2043
BDW2748	21.0	1400	1466	1506	1567	1789	1947	2105

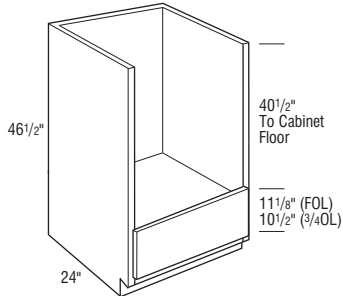
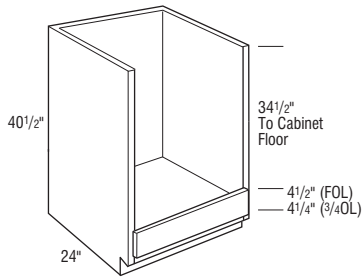

Notes below apply to all products in section above:

- Drawer front is a false front.
- Increased Depths available in 1/4" increments from 24 1/4" to 30".
- Reduced Depths available in 1/4" increments from 6" to 23 3/4".

Door & Drawer Options

AF	AOMBWB	CC	CG	GAMD	IFHG	MD	PRMD	PTOWB	SHMD	SPLITDR	SPLITDRWS	TCP
----	--------	----	----	------	------	----	------	-------	------	---------	-----------	-----

End Panel Options

AUTH	CSFPE	EXBK	FFD	FL/FR	FPE	INTGE	IPE
✓	✓			✓	✓	✓	✓

Custom Modification Options

ADD_SHLF	ADDTK	CBO	CCO	CFNT0	CFP	CFRMO	CHGDRW	CLIP	CMAT	CND	CSDGBK	DRT	DRWSEC	DRWTK	EX	EX_OL	FBFL	FD
								✓			✓				✓	✓		
FDSRTBTM	FLUT	FTK	ID	IH	INVFRM	IW	LIGHT	MIP	OBRB	PFINBTMB	RD	RECTK	RECTK_6	RECTKFR6	RH	ROSFLUT	RW	
			✓					✓			✓							
RW	SBCADDY	SBCADDYSM	SCPDRW	SRT	STW	TD	TKP	TVR	UDBX	URT	VTK	WS	WTC	WTKCUP	WTR			
									✓		✓	✓			✓			

SINK FRONT, 34 1/2" HIGH

	SF18 L or R	2.9	843	878	912	963	1010	1108	1206
--	-------------	-----	-----	-----	-----	-----	------	------	------

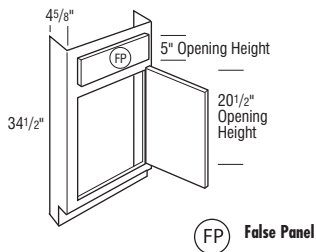

• Floor included.

Door & Drawer Options

AF	AOMBWB	CC	CG	GAMD	IFHG	MD	PRMD	PTOWB	SHMD	SPLITDR	SPLITDRWS	TCP
		✓	✓	✓	✓	✓			✓			

End Panel Options

AUTH	CSFPE	EXBK	FFD	FL/FR	FPE	INTGE	IPE

Custom Modification Options

ADD_SHLF	ADDTK	CBO	CCO	CFNT0	CFP	CFRMO	CHGDRW	CLIP	CMAT	CND	CSDGBK	DRT	DRWSEC	DRWTK	EX	EX_OL	FBFL	FD
																✓	✓	
FDSRTBTM	FLUT ¹	FTK	ID	IH	INVFRM	IW	LIGHT	MIP	OBRB	PFINBTMB	RD	RECTK	RECTK_6	RECTKFR6	RH	ROSFLUT	RT	
	✓	✓	✓					✓	✓						✓	✓		
RW	SBCADDY	SBCADDYSM	SCPDRW	SRT	STW	TD	TKP	TVR	UDBX	URT	VTK	WS	WTC	WTKCUP	WTR			
									✓		✓	✓			✓			

¹ Not available with 6" fluting.

Sink Fronts

SINK FRONT, 34 1/2" HIGH

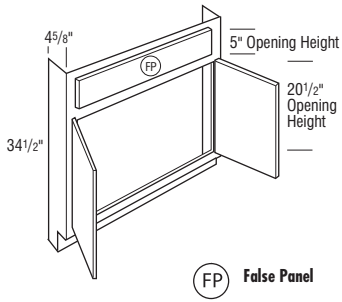

FP False Panel

	Cubic Feet	1	2	3	4	5	6	7
SF24	3.8	1147	1203	1247	1290	1385	1497	1609
SF30	4.7	1242	1303	1348	1422	1512	1651	1790
SF36	5.6	1288	1348	1397	1468	1557	1703	1849

- Floor included.

Door & Drawer Options

AF	AOMBWB	CC	CG	GAMD	IFHG	MD	PRMD ¹	PTOWB	SHMD	SPLITDR ¹	SPLITDRWS ¹	TCP
			✓	✓	✓	✓	✓		✓	✓	✓	

End Panel Options

AUTH	CSFPE	EXBK	FFD	FL/FR	FPE	INTGE	IPE

Custom Modification Options

ADD_SHLF	ADDTK	CBO	CCO	CFNT0	CFP	CFRMO	CHGDRW	CLIP	CMAT	CND	CSDGBK	DRT	DRWSEC	DRWTK	EX	EX_OL	FBFL	FD
															✓	✓		

FDSRTBTM	FLUT ²	FTK	ID	IH	INVFRM	IW	LIGHT	MIP	OBRB	PFINBTMB	RD	RECTK	RECTK_6	RECTKFR6	RH	ROSFLUT	RT
		✓	✓	✓				✓	✓						✓	✓	

RW	SBCADDY	SBCADDYSM	SCPDRW	SRT	STW	TD	TKP	TVR	UDBX	URT	VTK	WS	WTCD	WTKCUP	WTR
								✓			✓	✓			✓

¹ Not available on 24" wide.

² Not available with 6" fluting.

SINK FRONT BOTTOM, 23 1/16" DEEP, 48" WIDE

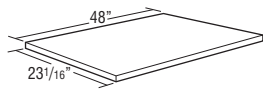

SFB48	0.3	60	60	60	60	60	60	60
--------------	-----	----	----	----	----	----	----	----

- 1/2" thick.
- Trimmable.
- Sink Front Bottoms are designed for use with Sink Bases ordered with CFNT0 modification.

Modifications
Are Not
Available

ANGLED CORNER SINK FRONT BOTTOM, 36", 39", or 42" DEEP

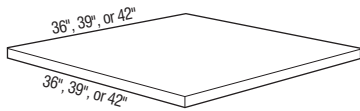

ACSF36	0.4	133	133	133	133	133	133	133
ACSF39	0.4	149	149	149	149	149	149	149
ACSF42	0.5	159	159	159	159	159	159	159

- 1/2" thick.
- Angled Corner Sink Front Bottoms are designed for use with Angled Corner Sink Fronts.

Modifications
Are Not
Available

IH/RH availability charts starting on page G•40.
IW/RW availability charts starting on page G•46.

Angled Corner Sink Base Cabinets

ANGLED CORNER SINK BASE, 34 1/2" HIGH

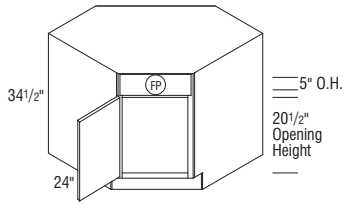

FP False Panel

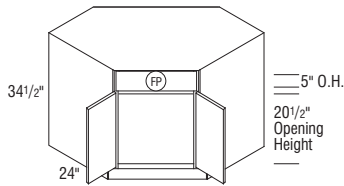

FP False Panel

	Cubic Feet	1	2	3	4	5	6	7
ACS36 L or R	30.1	2753	2885	2979	3142	3317	3617	3917
ACS39 L or R	35.0	2887	3026	3126	3294	3475	3786	4097
ACS42	40.3	3029	3171	3280	3452	3643	3973	4303

Notes below apply to all products in section above:

- Touch-up kit (TUK) and Owner's Guide included.

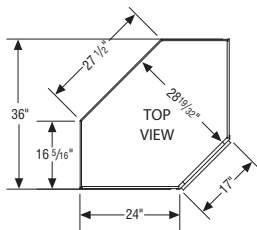

36" Shown

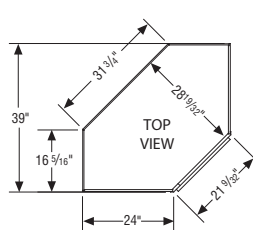

39" Shown

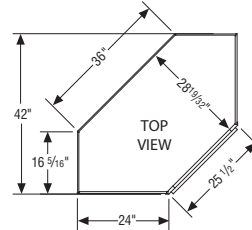

42" Shown

Door & Drawer Options

AF	AOMBWB	CC	CG	GAMD	IFHG	MD	PRMD	PTOWB	SHMD	SPLITDR	SPLITDRWS	TCP
			✓	✓	✓	✓	✓			✓		

End Panel Options

AUTH ¹	CSFPE	EXBK	FFD	FL/FR	FPE	INTGE	IPE
✓	✓			✓	✓		

Custom Modification Options

ADD_SHLF	ADDTK	CBO	CCO	CFNTO	CFP	CFRMO	CHGDRW	CLIP	CMAT	CND	CSDGBK	DRT	DRWSEC	DRWTK	EX	EX_OL	FBFL	FD	
						✓				✓									

FDSRTBTM	FLUT	FTK	ID	IH	INVFRM	IW	LIGHT	MIP	OBRB	PFINBTMB	RD	RECTK	RECTK_6	RECTKFR76	RH	ROSLUT	RT
		✓	✓					✓	✓			✓					

RW	SBCADDY	SBCADDYSM	SCPDRW	SRT	STW	TD	TKP	TVR	UDBX	URT	VTK	WS	WTCD	WTKCUP	WTR
								✓			✓				✓

¹ Not available on authentic flush ends both.

Angled Corner Sink Base Cabinets

	Cubic Feet	1	2	3	4	5	6	7
ANGLED CORNER SINK BASE with TILT-OUT TRAY, 34 1/2" HIGH, 24" DEEP								
ACS36ST L or R	30.1	2941	3067	3169	3326	3499	3800	4101
ACS39ST L or R	35.0	3073	3211	3315	3481	3661	3975	4289

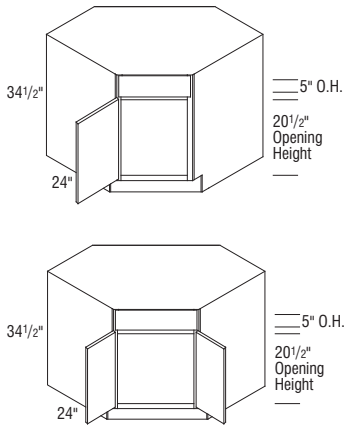

ACS42ST	40.3	3213	3357	3464	3639	3830	4159	4488
----------------	------	------	------	------	------	------	------	------

Notes below apply to all products in section above:

- Touch-up kit (TUK) and Owner's Guide included.
- One drawer front with one 1 11/16" deep stainless steel Tilt-out Tray attached.

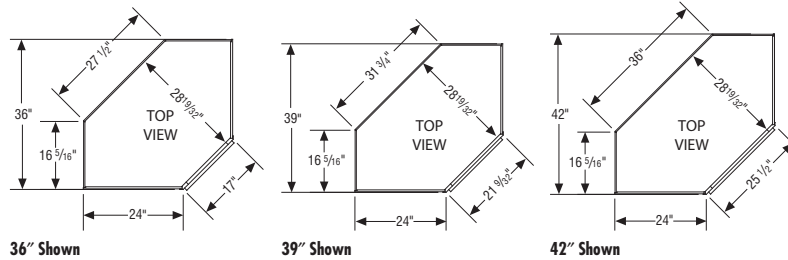

Door & Drawer Options

AF	AOMBWB	CC	CG	GAMD	IFHG	MD	PRMD	PTOWB	SHMD	SPLITDR	SPLITDRWS	TCP
		✓	✓	✓	✓	✓	✓		✓			

End Panel Options

AUTH ¹	CSFPE	EXBK	FFD	FL/FR	FPE	INTGE	IPE
✓	✓	✓	✓	✓	✓	✓	✓

Custom Modification Options

ADD	SHLF	ADDTK	CBO	CCO	CFNT0	CFP	CFRMO	CHGDRW	CLIP	CMAT	CND	CSDGBK	DRT	DRWSEC	DRWTK	EX	EX_OL	FBFL	FD	
			✓		✓		✓				✓									

FDSRTBTM	FLUT	FTK	ID	IH	INVFRM	IW	LIGHT	MIP	OBRB	PFINBTMB	RD	RECTK	RECTK_6	RECTKFRT6	RH	ROSFLUT	RT
		✓		✓				✓	✓			✓				✓	

RW	SBCADDY	SBCADDYSM	SCPDRW	SRT	STW	TD	TKP	TVR	UDBX	URT	VTK	WS	WTCO	WTKCUP	WTR
								✓			✓				✓

¹ Not available on authentic flush ends both.

IH/RH availability charts starting on page G•40.
IW/RW availability charts starting on page G•46.

Angled Corner Sink Fronts & Drop-in Range Bases

ANGLED CORNER SINK FRONT, 34 1/2" HIGH

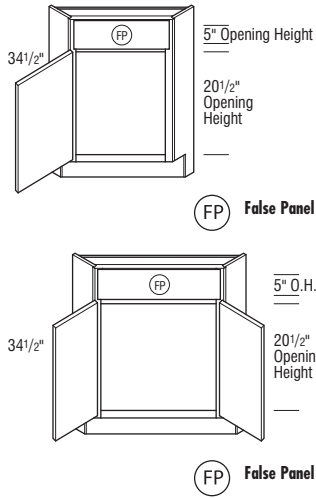

	Cubic Feet	1	2	3	4	5	6	7
ACSF36 L or R	2.9	1276	1329	1370	1441	1517	1653	1789
ACSF39 L or R	3.6	1338	1399	1439	1517	1581	1717	1853
ACSF42	4.2	1401	1464	1517	1586	1667	1811	1955

Notes below apply to all products in section above:

- Floor included and packed separately.
- Touch-up kit (TUK) and Owner's Guide included.

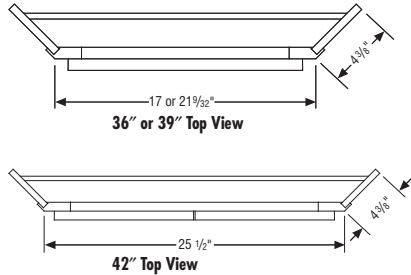

Door & Drawer Options

AF	AOMBWB	CC	CG	GAMD	IFHG	MD	PRMD	PTOWB	SHMD	SPLITDR ¹	SPLITDRWS ¹	TCP

End Panel Options

AUTH	CSFPE	EXBK	FFD	FL/FR	FPE	INTGE	IPE

Custom Modification Options

ADD_SHLF	ADDTK	CBO	CCO	CFNTO	CFP	CFRMO	CHGDRW	CLIP	CMAT	CND	CSDGBK	DRT	DRWSEC	DRWTK	EX	EX_OL	FBFL	FD		
FDSRTBTM	FLUT	FTK	ID	IH	INVFRM	IW	LIGHT	MIP	OBRB	PFINBTMB	RD	RECTK	RECTK_6	RECTKFR6	RH	ROSFLUT	RT			
RW	SBCADDY	SBCADDYSM	SCPDRW	SRT	STW	TD	TKP	TVR	UDBX	URT	VTK	WS	WTCD	WTKCUP	WTR					

¹ Only available on 42" wide.

TWO DRAWER BASE, DROP-IN RANGE, 34 1/2" HIGH, 24" DEEP

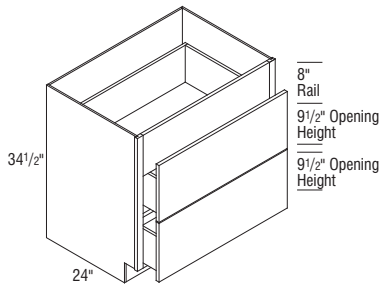

2DB30DR	17.4	2977	3121	3232	3406	3608	3940	4272
2DB36DR	20.7	3112	3261	3378	3561	3770	4119	4468

- 8" panel can be trimmed up to 6 1/2".
- Reduced Depths available in 1/4" increments from 12" to 23 3/4".

Door & Drawer Options

AF	AOMBWB	CC	CG	GAMD	IFHG	MD	PRMD	PTOWB	SHMD	SPLITDR	SPLITDRWS	TCP

End Panel Options

AUTH	CSFPE	EXBK	FFD	FL/FR	FPE	INTGE	IPE

Custom Modification Options

ADD_SHLF	ADDTK	CBO	CCO	CFNTO	CFP	CFRMO	CHGDRW	CLIP	CMAT	CND	CSDGBK	DRT	DRWSEC	DRWTK	EX	EX_OL	FBFL	FD		
FDSRTBTM	FLUT ¹	FTK	ID	IH	INVFRM	IW ²	LIGHT	MIP	OBRB	PFINBTMB	RD	RECTK	RECTK_6	RECTKFR6	RH	ROSFLUT	RT			
RW ²	SBCADDY	SBCADDYSM	SCPDRW	SRT	STW	TD	TKP	TVR	UDBX	URT	VTK	WS	WTCD	WTKCUP	WTR					

¹ 6" fluting both not available on 30" wide.

² Only available on 36" wide.

Drop-in Range Bases

TWO DRAWER BASE with REDUCED DRAWERS, DROP-IN RANGE, 34 1/2" HIGH, 24" DEEP

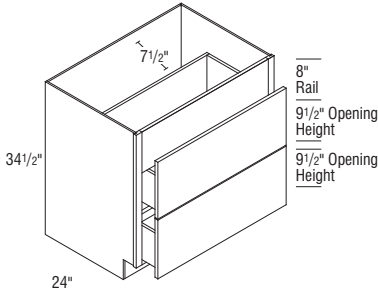

	Cubic Feet	1	2	3	4	5	6	7
2DB30RDR	17.4	2977	3121	3232	3406	3608	3940	4272
2DB36RDR	20.7	3112	3261	3378	3561	3770	4119	4468

- 8" panel can be trimmed up to 6 1/2".
- Drawers are reduced 6" to allow for proper range installation. Clearance dimension is 7 1/2".

Door & Drawer Options

AF	AOMBWB	CC	CG	GAMD	IFHG	MD	PRMD	PTOWB	SHMD	SPLITDR	SPLITDRWS	TCP
----	--------	----	----	------	------	----	------	-------	------	---------	-----------	-----

End Panel Options

AUTH	CSFPE	EXBK	FFD	FL/FR	FPE	INTGE	IPE
------	-------	------	-----	-------	-----	-------	-----

Custom Modification Options

ADD	SHLF	ADDTK	CBO	CCO	CFNTD	CFP	CFRMO	CHGDRW	CLIP	CMAT	CND	CSDGBK	DRT	DRWSEC	DRWTK	EX	EX_OL	FBFL	FD
-----	------	-------	-----	-----	-------	-----	-------	--------	------	------	-----	--------	-----	--------	-------	----	-------	------	----

FDSRTBTM	FLUT ¹	FTK	ID	IH	INVFRM	IW ²	LIGHT	MIP	OBRB	PFINBTMB	RD	RECTK	RECTK_6	RECTKFR6	RH	ROSFLUT ³	RT
----------	-------------------	-----	----	----	--------	-----------------	-------	-----	------	----------	----	-------	---------	----------	----	----------------------	----

RW ²	SBCADDY	SBCADDYSM	SCPDRW	SRT	STW	TD	TKP	TVR	UDBX	URT	VTK	WS	WTCB	WTKCUP	WTR
-----------------	---------	-----------	--------	-----	-----	----	-----	-----	------	-----	-----	----	------	--------	-----

¹ Fluting both 3" not available on 36" wide. Not available with 6" fluting.

² Only available on 36" wide.

³ Fluting both not available on 36" wide.

BASE, DROP-IN RANGE, 34 1/2" HIGH, 24" DEEP

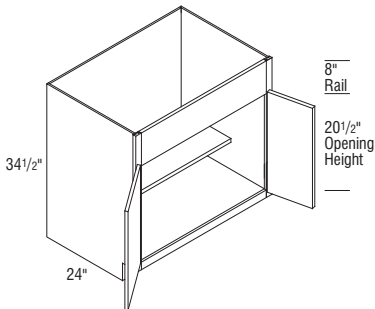

B30DR	17.4	1896	1989	2056	2172	2281	2500	2719
B33DR	19.0	1947	2044	2114	2234	2349	2570	2791
B36DR	20.7	1998	2099	2172	2296	2416	2640	2864
B39DR	22.4	2138	2246	2324	2457	2585	2825	3065

- One adjustable 15" deep shelf.
- 8" panel can be trimmed up to 6 1/2".
- Increased Depths available in 1/4" increments from 24 1/4" to 30".
- Reduced Depths available in 1/4" increments from 6" to 23 3/4".

Door & Drawer Options

AF	AOMBWB	CC	CG	GAMD	IFHG	MD	PRMD	PTOWB	SHMD	SPLITDR	SPLITDRWS	TCP
----	--------	----	----	------	------	----	------	-------	------	---------	-----------	-----

End Panel Options

AUTH	CSFPE	EXBK	FFD	FL/FR	FPE	INTGE	IPE
------	-------	------	-----	-------	-----	-------	-----

Custom Modification Options

ADD	SHLF	ADDTK	CBO	CCO	CFNTD	CFP	CFRMO	CHGDRW	CLIP	CMAT	CND	CSDGBK	DRT	DRWSEC	DRWTK	EX	EX_OL	FBFL	FD
-----	------	-------	-----	-----	-------	-----	-------	--------	------	------	-----	--------	-----	--------	-------	----	-------	------	----

FDSRTBTM	FLUT	FTK	ID	IH	INVFRM	IW ¹	LIGHT	MIP	OBRB	PFINBTMB	RD	RECTK	RECTK_6	RECTKFR6	RH	ROSFLUT	RT
----------	------	-----	----	----	--------	-----------------	-------	-----	------	----------	----	-------	---------	----------	----	---------	----

RW ¹	SBCADDY	SBCADDYSM	SCPDRW	SRT	STW	TD	TKP	TVR	UDBX	URT	VTK	WS	WTCB	WTKCUP	WTR
-----------------	---------	-----------	--------	-----	-----	----	-----	-----	------	-----	-----	----	------	--------	-----

¹ Only available on 36" wide.

IH/RH availability charts starting on page G-40.
IW/RW availability charts starting on page G-46.

BASE with REDUCED DEPTH ROLL TRAYS, DROP-IN RANGE, 34 1/2" HIGH, 24" DEEP

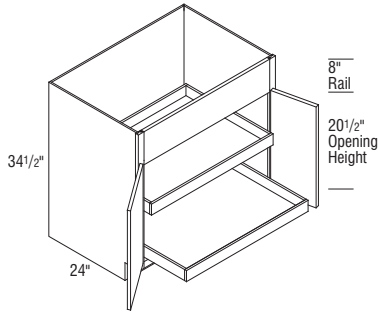

	Cubic Feet	1	2	3	4	5	6	7
B30RTDR	17.4	2676	2768	2831	2951	3061	3277	3493
B36RTDR	20.7	2777	2877	2951	3071	3195	3417	3639

- 8" panel can be trimmed up to 6 1/2".
- Contains two easily adjustable roll trays.
- Reduced Depths available in 1/4" increments from 12" to 23 3/4".

Door & Drawer Options

AF	AOMBWB	CC	CG	GAMD	IFHG	MD	PRMD	PTOWB	SHMD	SPLITDR	SPLITDRWS	TCP
			✓	✓	✓	✓	✓		✓			

End Panel Options

AUTH	CSFPE	EXBK	FFD	FL/FR	FPE	INTGE	IPE
✓	✓	✓		✓	✓	✓	✓

Custom Modification Options

ADD_SHLF	ADDTK	CBO	CCO	CFNTD	CFP	CFRMO	CHGDRW	CLIP	CMAT	CND	CSDGBK	DRT	DRWSEC	DRWTK	EX	EX_OL	FBFL	FD
														✓	✓	✓	✓	✓

FDSRTBTM	FLUT	FTK	ID	IH	INVFRM	IW	LIGHT	MIP	OBRB	PFINBTMB	RD	RECTK	RECTK_6	RECTKFR6	RH	ROSFLUT	RT
	✓	✓	✓					✓	✓		✓	✓	✓	✓	✓	✓	✓

RW ¹	SBCADDY	SBCADDYSM	SCPDWR	SRT	STW	TD	TKP	TVR ²	UDBX	URT	VTK	WS	WTC	WTKCUP	WTR
✓								✓	✓		✓	✓			✓

¹ Not available on 30" wide. TVRAV and style B-L not available on 36" wide.

BASE with ROLL TRAYS, DROP-IN RANGE, 34 1/2" HIGH, 24" DEEP

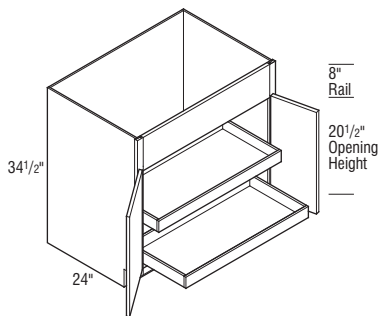

	Cubic Feet	1	2	3	4	5	6	7
B30RRTDR	17.4	2676	2768	2831	2951	3061	3277	3493
B36RRTDR	20.7	2777	2877	2951	3071	3195	3417	3639

- 8" panel can be trimmed up to 6 1/2".
- Roll trays are reduced 6" to allow for proper range installation. Clearance dimension is 5 1/4".
- Contains two easily adjustable roll trays.

Door & Drawer Options

AF	AOMBWB	CC	CG	GAMD	IFHG	MD	PRMD	PTOWB	SHMD	SPLITDR	SPLITDRWS	TCP
			✓	✓	✓	✓	✓		✓			

End Panel Options

AUTH	CSFPE	EXBK	FFD	FL/FR	FPE	INTGE	IPE
✓	✓	✓		✓	✓	✓	✓

Custom Modification Options

ADD_SHLF	ADDTK	CBO	CCO	CFNTD	CFP	CFRMO	CHGDRW	CLIP	CMAT	CND	CSDGBK	DRT	DRWSEC	DRWTK	EX	EX_OL	FBFL	FD
														✓	✓	✓	✓	✓

FDSRTBTM	FLUT ¹	FTK	ID	IH	INVFRM	IW	LIGHT	MIP	OBRB	PFINBTMB	RD	RECTK	RECTK_6	RECTKFR6	RH	ROSFLUT	RT
	✓	✓	✓					✓	✓		✓	✓	✓	✓	✓	✓	✓

RW ²	SBCADDY	SBCADDYSM	SCPDWR	SRT	STW	TD	TKP	TVR ³	UDBX	URT	VTK	WS	WTC	WTKCUP	WTR
✓								✓	✓		✓	✓			✓

¹ Not available with 6" fluting.

² Not available on 30" wide.

³ TVRAV and style B-L not available on 36" wide.

Range Platform & Range Panel

RANGE PLATFORM with DRAWERS, 13 1/2" HIGH, 24" DEEP

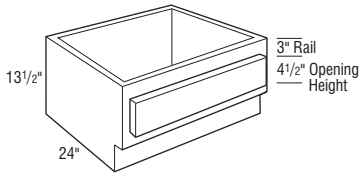

	Cubic Feet	1	2	3	4	5	6	7
R21PD	5.2	1181	1242	1284	1351	1434	1565	1696
R24PD	5.9	1212	1272	1315	1388	1468	1607	1746
R27PD	6.6	1241	1302	1347	1416	1501	1644	1787
R30PD	7.2	1261	1322	1369	1442	1527	1668	1809
R33PD	7.9	1279	1343	1391	1464	1549	1691	1833
R36PD	8.6	1316	1385	1433	1505	1598	1742	1886

- Overall cabinet height must be specified: 13 1/2", 15 1/2", 18", 19 1/2", 20 1/2" and 21 3/4".
- Maintain 3" rail above drawer for full overlay clearance.
- Reduced Depths available in 1/4" increments is from 12" to 23 3/4".
- Drawer opening height must be specified: 4 1/2", 6 1/2", 9", 10 1/2", 11 1/2", and 12 3/4".

Door & Drawer Options

AF	AOMBWB	CC	CG	GAMD	IFHG	MD	PRMD	PTOWB	SHMD	SPLITDR	SPLITDRWS ¹	TCP

End Panel Options

AUTH ²	CSFPE	EXBK	FFD	FL/FR	FPE	INTGE	IPE

Custom Modification Options

ADD	SHLF	ADDTK	CBO	CCO	CFNT0	CFP	CFRMO	CHGDRW	CLIP	CMAT	CND	CSDGBK	DRT	DRWSEC	DRWTK	EX	EX_OL	FBFL	FD

FDSRTBTM	FLUT ³	FTK	ID	IH	INVFRM	IW	LIGHT	MIP	OBRB	PFINBTMB	RD	RECTK	RECTK_6	RECTKFR6	RH	ROSLUT	RW

RW	SBCADDY	SBCADDYSM	SCPDRW	SRT	STW	TD	TKP	TVR ⁴	UDBX	URT	VTK	WS	WTCD	WTKCUP	WTR ⁴

- ¹ Not available on 21" wide.
² Not available on authentic flush ends both.
³ Fluting both 6" not available on 21" wide.
⁴ Not available on 21"-27" wide.

RANGE PANEL

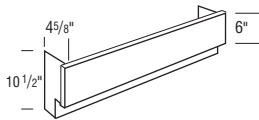

DRP30	1.6	240	240	240	240	240	240	240
--------------	-----	-----	-----	-----	-----	-----	-----	-----

- Panel height must be specified between 6" to 12" in 1/4" increments.

Door & Drawer Options

AF	AOMBWB	CC	CG	GAMD	IFHG	MD	PRMD	PTOWB	SHMD	SPLITDR	SPLITDRWS	TCP

End Panel Options

AUTH	CSFPE	EXBK	FFD	FL/FR	FPE	INTGE	IPE

Custom Modification Options

ADD	SHLF	ADDTK	CBO	CCO	CFNT0	CFP	CFRMO	CHGDRW	CLIP	CMAT	CND	CSDGBK	DRT	DRWSEC	DRWTK	EX	EX_OL	FBFL	FD

FDSRTBTM	FLUT ¹	FTK	ID	IH	INVFRM	IW	LIGHT	MIP	OBRB	PFINBTMB	RD	RECTK ²	RECTK_6	RECTKFR6	RH	ROSLUT	RW

RW	SBCADDY	SBCADDYSM	SCPDRW	SRT	STW	TD	TKP	TVR	UDBX	URT	VTK	WS	WTCD	WTKCUP	WTR

- ¹ Not available with 6" fluting.
² Only available on RECTKALL

IH/RH availability charts starting on page G•40.
 IW/RW availability charts starting on page G•46.

Base Corner Cabinets

BASE CORNER, 34 1/2" HIGH, 24" DEEP

Cubic Feet	1	2	3	4	5	6	7
BC36 L or R	16.1	1838	1907	1977	2046	2081	2151
BC39 L or R	19.6	1956	2031	2105	2179	2217	2291
BC42 L or R	24.4	2023	2100	2177	2254	2292	2370
BC45 L or R	24.4	2134	2215	2297	2378	2419	2501
BC48 L or R	26.0	2194	2278	2362	2446	2488	2572

- Includes one 3" filler, shipped unattached.
- L or R denotes blind.
- Includes one adjustable 15" deep shelf.
- Not recommended for use next to an appliance deeper than standard cabinet depth.
- Door will be hinged on same side as blind section.
- Reduced Heights available in 1/4" increments from 12 1/4" to 23 3/4".

SKU	A	B	C	D	E	F
BC36	7 1/2"	9"	27"	36"	9"	3"
BC39	9"	9"	30"	39"	9"	4 1/2"
BC42	13 1/2"	9"	39"	42"	3"	3"
BC45	15"	9"	42"	45"	3"	4 1/2"
BC48	16 1/2"	9"	45"	48"	3"	6"

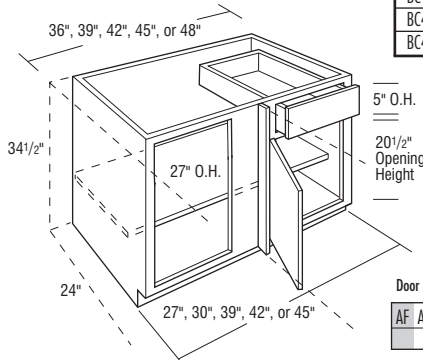

Door & Drawer Options

AF	AOMBWB	CC	CG	GAMD	IFHG	MD	PRMD	PTOWB	SHMD	SPLITDR	SPLITDRWS	TCP

End Panel Options

AUTH	CSFPE	EXBK	FFD	FL/FR	FPE	INTGE	IPE

Custom Modification Options

ADD_SHLF	ADDTK	CBO	CCO	CFNT0	CFP	CFRMO	CHGDRW	CLIP ¹	CMAT	CND	CSDGBK	DRT	DRWSEC	DRWTK	EX	EX_OL	FBFL	FD
FDSRTBTM	FLUT ²	FTK	ID	IH	INVFRM	IW	LIGHT	MIP	OBRB	PFINBTMB	RD	RECTK	RECTK_6	RECTKERT6	RH	ROSFLUT	RT	
RW	SBCADDY	SBCADDYSM	SCPDRW	SRT	STW	TD	TKP	TVR	UDBX	URT	VTK	WS	WTC ³	WTKCUP ³	WTR			

¹ Not available on BC36 L or R.

² Not available with 6" fluting.

³ Only available on BC45 L or R.

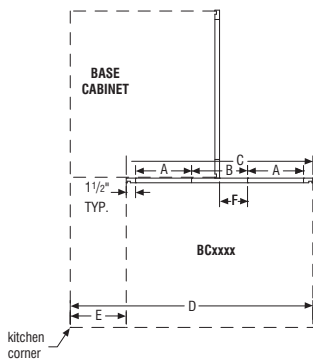

kitchen corner

Base Corner Cabinets

BASE CORNER FULL WIDTH, 34 1/2" HIGH, 24" DEEP

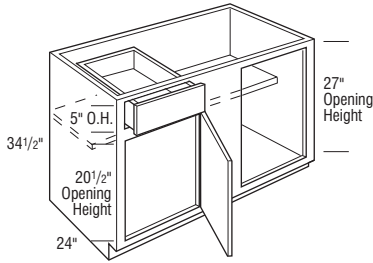

Right shown

	Cubic Feet	1	2	3	4	5	6	7
BCFW36 L or R	20.7	1573	1647	1705	1790	1880	2043	2206
BCFW39 L or R	22.4	1634	1707	1763	1853	1941	2111	2281
BCFW42 L or R	24.0	1664	1739	1806	1892	1989	2166	2343
BCFW45 L or R	25.7	1757	1833	1896	1994	2083	2263	2443
BCFW48 L or R	27.3	1826	1908	1973	2080	2175	2368	2561

- Includes one 3" filler, shipped unattached.
- Door will be hinged on same side as blind section.
- One adjustable 15" deep shelf.
- Can be pulled 3".
- Should not be used next to appliances.
- Use of filler or Extended Stile is required for full overlay doors to operate properly.
- Reduced Depths available in 1/4" increments from 12" to 23 3/4".
- When an Inset or Beaded Inset style is selected, door and drawer front will be slab on 36" wide unit.

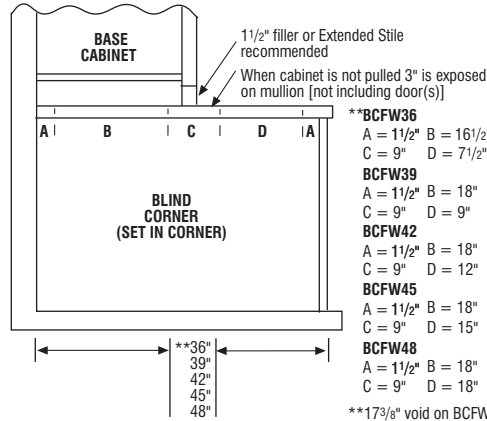

Top View

Door & Drawer Options

AF	AOMBWB	CC	CG	GAMD	IFHG	MD	PRMD	PTOWB	SHMD	SPLITDR	SPLITDRWS	TCP

End Panel Options

AUTH	CSFPE	EXBK	FFD	FL/FR	FPE	INTGE	IPE

Custom Modification Options

ADD	SHLF	ADDTK	CBO	CCO	CFNT0	CFP	CFRMO	CHGDRW	CLIP	CMAT	CND	CSDGBK	DRT	DRWSEC	DRWTK	EX	EX_OL	FBFL	FD
FDSRTBTM	FLUT ¹	FTK	ID	IH	INVFRA	IW	LIGHT	MIP	OBRB	PFINBTMB	RD	RECTK	RECTK_6	RECTKFRT6	RH	ROSFLOT	RT		
RW	SBCADDY	SBCADDYSM	SCPDWR	SRT	STW	TD	TKP	TVR	UDBX	URT	VTK	WS ²	WTC	WTKCUP	WTR				

¹ 6" fluting not available on 36" x 42" wide. Fluting both 6" not available.

² Not available on 36" wide or with wide stile both.

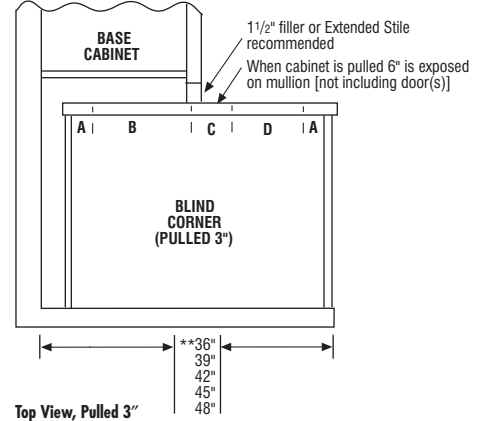

Top View, Pulled 3"

IH/RH availability charts starting on page G-40.
IW/RW availability charts starting on page G-46.

BASE CORNER PULL-OUT, 34 1/2" HIGH, 24" DEEP

L O G I X

Cubic Feet	1	2	3	4	5	6	7
BC45PO L or R	24.4	5505	5722	5939	6156	6265	6481
BC48PO L or R	24.4	5566	5785	6004	6224	6334	6552

- Includes one 3" filler, shipped unattached.
- L or R denotes blind.
- Pull-out features four adjustable wood shelves with chrome surrounds.
- Wire pull-out dimensions: 10 3/4" wide x 17 1/4" deep x 2 11/16" high.
- Door will be hinged on same side as blind section.
- Smart Stop feature not available on pull-out.
- Not recommended for use next to an appliance deeper than standard cabinet depth and cannot be installed next to a wall. Adjacent cabinet hardware may interfere with adjustable shelf position on pull-out.
- For pull-out to function properly, 10" of adjacent space is required with no obstruction beyond 1 3/4" in front of the cabinet face frame.
- Only available in Inset and Beaded Inset when used in conjunction with a finial hinge.

SKU	A	B	C	D	E	F
BC45PO	15"	9"	42"	45"	3"	4 1/2"
BC48PO	16 1/2"	9"	45"	48"	3"	6"

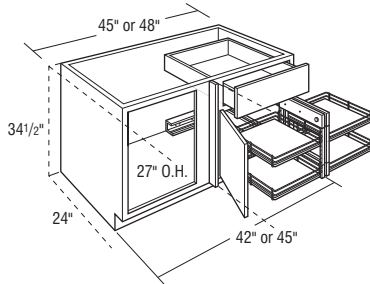

5" O.H.

20 1/2" Opening Height

Door & Drawer Options

AF	AOMBWB	CC	CG	GAMD	IFHG	MD	PRMD	PTOWB	SHMD	SPLITDR	SPLITDRWS	TCP

End Panel Options

AUTH	CSFPE	EXBK	FFD	FL/FR	FPE	INTGE	IPE

Custom Modification Options

ADD_SHLF	ADDTK	CBO	CCO	CFNTO	CFP	CFRMO	CHGDRW	CLIP	CMAT	CND	CSDGBK	DRT	DRWSEC	DRWTK	EX	EX_OL	FBFL	FD	

FDSRTBTM	FLUT ¹	FTK	ID	IH	INVFRM	IW	LIGHT	MIP	OBRB	PFINBTMB	RD	RECTK	RECTK_6	RECTKFRT6	RH	ROSFLUT	RT

RW	SBCADDY	SBCADDYSM	SCPDRW	SRT	STW	TD	TKP	TVR	UDBX	URT	VTK	WS	WTCB ²	WTKCUP ²	WTR

¹ Not available with 6" fluting.

² Only available on 45" wide.

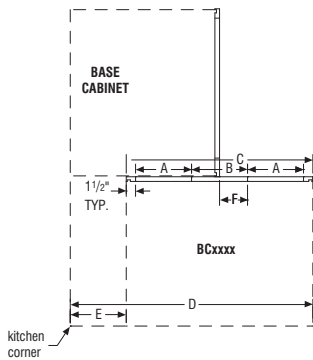

Base Corner Cabinets

Cubic Feet	1	2	3	4	5	6	7	
BCFW45PO L or R	25.7	4180	4256	4322	4418	4505	4686	4867
BCFW48PO L or R	27.3	4249	4330	4397	4502	4598	4790	4982

BASE CORNER FULL WIDTH PULL-OUT, 34 1/2" HIGH, 24" DEEP

L O G I X

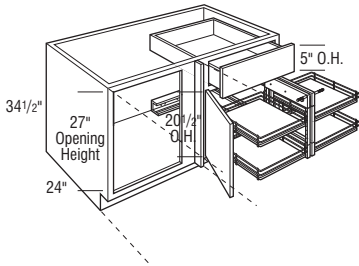

Left shown

- Includes one 3" filler, shipped unattached.
- Door will be hinged on same side as blind section.
- Can be pulled 3".
- Smart Stop feature not available on pull-out.
- Not recommended for use next to a range.
- Interior pull-out drawer is 10 5/8" W by 17 1/8" D by 2 3/4" H.
- Use of filler or Extended Stile is required for full overlay doors to operate properly.
- Only available in Inset and Beaded Inset when used in conjunction with a finial hinge.

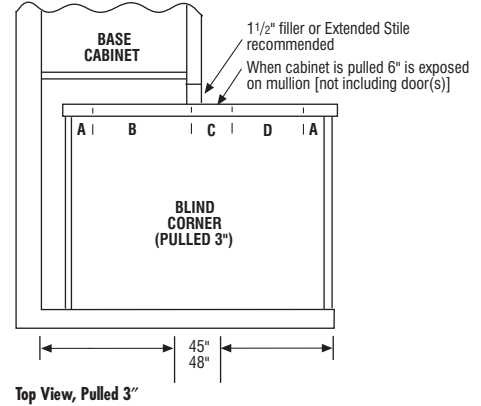
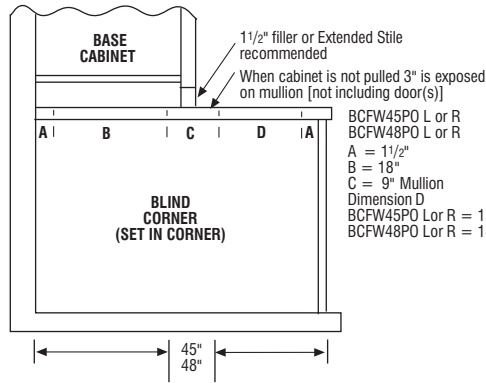

BCFW45PO L or R
BCFW48PO L or R
A = 11/2"
B = 18"
C = 9" Mullion
Dimension D
BCFW45PO Lor R = 15"
BCFW48PO Lor R = 18"

Door & Drawer Options

AF	AOMBWB	CC	CG	GAMD	IFHG	MD	PRMD	PTOWB	SHMD	SPLITDR	SPLITDRWS	TCP
	✓	✓	✓	✓	✓	✓	✓	✓	✓			

End Panel Options

AUTH	CSFPE	EXBK	FFD	FL/FR	FPE	INTGE	IPE
✓	✓	✓	✓	✓	✓	✓	✓

Custom Modification Options

ADD	SHLF	ADDTK	CBO	CCO	CFNTO	CFP	CFRMO	CHGDRW	CLIP	CMAT	CND	CSDGBK	DRT	DRWSEC	DRWTK	EX	EX_OL	FBFL	FD
						✓					✓	✓			✓	✓	✓	✓	✓

FDSRTBTM	FLUT ¹	FTK	ID	IH	INVFRM	IW	LIGHT	MIP	OBRB	PFINBTMB	RD	RECTK	RECTK_6	RECTKFR6	RH	ROSFLUT	RT
	✓	✓	✓	✓	✓	✓	✓	✓	✓	✓	✓	✓	✓	✓	✓	✓	✓

RW	SBCADDY	SBCADDYSM	SCPDWR	SRT	STW	TD	TKP	TVR	UBX	URT	VTK	WS	WTCO	WTKCUP	WTR
			✓				✓	✓	✓	✓	✓	✓	✓	✓	✓

¹ Not available with 6" fluting.

IH/RH availability charts starting on page G•40.
IW/RW availability charts starting on page G•46.

BASE CORNER FULL WIDTH with ROLL TRAYS and SWING-OUT, 34 1/2" HIGH, 24" DEEP

L G I X

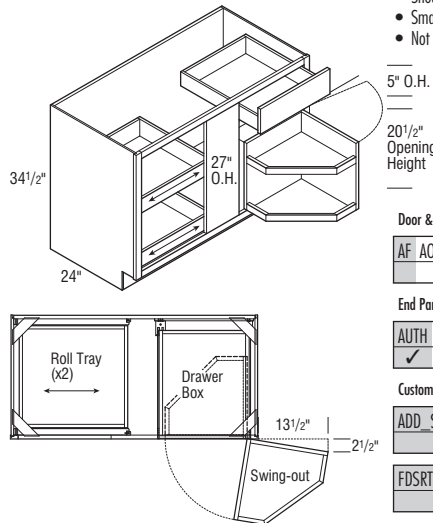

BCFW48SP L or R

- Includes one 3" filler, shipped unattached.
- L or R denotes blind.
- Swing-out hinged opposite door.
- Door will be hinged on same side as blind section.
- Two roll trays and swing-out installed.
- Swing-out is 3/4" natural plywood.
- Should not be used next to appliances, cabinets deeper than standard depth, or next to a wall.
- Smart Stop feature not available on pull-out.
- Not available with Inset and Beaded Inset.

Door & Drawer Options

AF	AOMBWB	CC	CG	GAMD	IFHG	MD	PRMD	PTOWB	SHMD	SPLITDR	SPLITDRWS	TCP

End Panel Options

AUTH	CSFPE	EXBK	FFD	FL/FR	FPE	INTGE	IPE

Custom Modification Options

ADD_SHLF	ADDTK	CBO	CCO	CFNTD	CFP	CFRMO	CHGDRW	CLIP	CMAT	CND	CSDGBK	DRT	DRWSEC	DRWTK	EX	EX_OL	FBFL	FD	
FDSRTBM	FLUT ¹	FTK	ID	IH	INVFRM	IW	LIGHT	MIP	OBRB	PFINBTMB	RD	RECTK	RECTK_6	RECTKFT6	RH	ROSFLUT	RT		
RW	SBCADDY	SBCADDYSM	SCPDRW	SRT	STW	TD	TKP	TVR	UDBX	URT	VTK	WS	WTC	WTKCUP	WTR				

¹ Not available with 6" fluting.

BASE CORNER FULL WIDTH with ARCHED PULL-OUT, 34 1/2" HIGH, 24" DEEP

L G I X

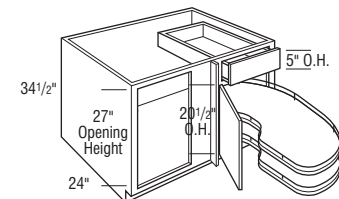

Left shown

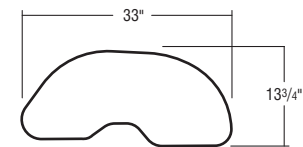

BCFW45CPO

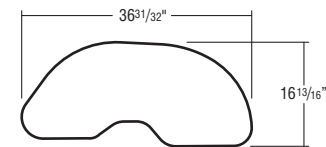

BCFW48CPO

BCFW45CPO L or R

BCFW48CPO L or R

- Includes one 3" filler, shipped unattached.
- Door must be hinged on same side as blind section.
- Can be pulled 3".
- Pull-out features Smart Stop.
- Only available in Inset and Beaded Inset when used in conjunction with a finial hinge.
- Includes two pull-out shelves with chrome wire surround. Shelf height can be adjusted in the field.
- When shelf is fully opened, it extends 27 3/4" from front edge of the face frame. Unit pulls out to the front only and can be installed next to a wall or appliance without side interference.
- Distance from surface of shelf to top edge of wire surround is 1 11/16".
- Maximum Weight Capacity: 44 lbs. per shelf.

Door & Drawer Options

AF	AOMBWB	CC	CG	GAMD	IFHG	MD	PRMD	PTOWB	SHMD	SPLITDR	SPLITDRWS	TCP

End Panel Options

AUTH	CSFPE	EXBK	FFD	FL/FR	FPE	INTGE	IPE

Custom Modification Options

ADD_SHLF	ADDTK	CBO	CCO	CFNTD	CFP	CFRMO	CHGDRW	CLIP	CMAT	CND	CSDGBK	DRT	DRWSEC	DRWTK	EX	EX_OL	FBFL	FD	
FDSRTBM	FLUT ¹	FTK	ID	IH	INVFRM	IW	LIGHT	MIP	OBRB	PFINBTMB	RD	RECTK	RECTK_6	RECTKFT6	RH	ROSFLUT	RT		
RW	SBCADDY	SBCADDYSM	SCPDRW	SRT	STW	TD	TKP	TVR	UDBX	URT	VTK	WS	WTC	WTKCUP	WTR				

¹ Not available with 6" fluting.

Base Corner Cabinets

FULL HEIGHT BASE CORNER FULL WIDTH with ARCHED PULL-OUT, 34 1/2" HIGH, 24" DEEP

L G I X

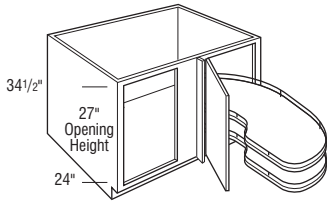

Left shown

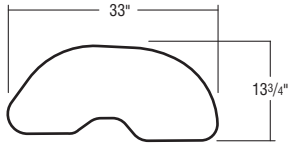

BCFWFH45CPO

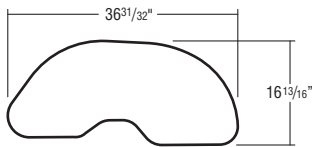

BCFWFH48CPO

Cubic Feet	1	2	3	4	5	6	7	
BCFWFH45CPO L or R	25.7	5154	5357	5560	5763	5864	5966	6068
BCFWFH48CPO L or R	27.3	5362	5567	5769	5972	6073	6175	6277

- Includes one 3" filler, shipped unattached.
- Door must be hinged on same side as blind section.
- Can be pulled 3".
- Pull-out features Smart Stop.
- Only available in Inset and Beaded Inset when used in conjunction with a finial hinge.
- Includes two pull-out shelves with chrome wire surround. Shelf height can be adjusted in the field.
- When shelf is fully opened, it extends 27 3/4" from front edge of the face frame. Unit pulls out to the front only and can be installed next to a wall or appliance without side interference.
- Distance from surface of shelf to top edge of wire surround is 1 11/16".
- Maximum Weight Capacity: 44 lbs. per shelf.

Door & Drawer Options

AF	AOMBWB	CC	CG	GAMD	IFHG	MD	PRMD	PTOWB	SHMD	SPLITDR	SPLITDRWS	TCP
			✓	✓	✓	✓	✓		✓			

End Panel Options

AUTH	CSFPE	EXBK	FFD	FL/FR	FPE	INTGE	IPE
✓	✓	✓	✓	✓	✓	✓	✓

Custom Modification Options

ADD	SHLF	ADDTK	CBO	CCO	CFNT0	CFP	CFRMO	CHGDRW	CLIP	CMAT	CND	CSDGBK	DRT	DRWSEC	DRWTK	EX	EX_OL	FBFL	FD
			✓	✓	✓		✓				✓	✓				✓	✓	✓	✓

FDSRTBTM	FLUT ¹	FTK	ID	IH	INVFRM	IW	LIGHT	MIP	OBRB	PFINBTMB	RD	RECTK	RECTK_6	RECTKFR6	RH	ROSFLUT	RT
	✓	✓	✓	✓				✓	✓			✓	✓	✓	✓	✓	

RW	SBCADDY	SBCADDYSM	SCPDWR	SRT	STW	TD	TKP	TVR	UDBX	URT	VTK	WS	WTCD	WTKCUP	WTR
												✓		✓	✓

¹ Not available with 6" fluting.

IH/RH availability charts starting on page G•40.
IW/RW availability charts starting on page G•46.

NEW FULL HEIGHT BASE CORNER FULL WIDTH, 34 1/2" HIGH, 24" DEEP

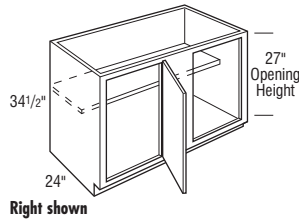

	Cubic Feet	1	2	3	4	5	6	7
BCFW36FH L or R	20.7	1533	1605	1661	1744	1831	1990	2149
BCFW39FH L or R	22.4	1592	1663	1717	1805	1891	2056	2221
BCFW42FH L or R	24.0	1621	1694	1759	1843	1937	2109	2281
BCFW45FH L or R	25.7	1712	1786	1847	1942	2029	2204	2379
BCFW48FH L or R	27.3	1779	1858	1922	2026	2118	2306	2494

- Includes one 3" filler, shipped unattached.
- Door will be hinged on same side as blind section.
- One adjustable 15" deep shelf.
- Can be pulled 3".
- Should not be used next to appliances.
- Use of filler or Extended Stile is required for full overlay doors to operate properly.
- Reduced Depths available in 1/4" increments from 12" to 23 3/4".
- Increased Depths available in 1/4" increments from 24 1/4" to 30".

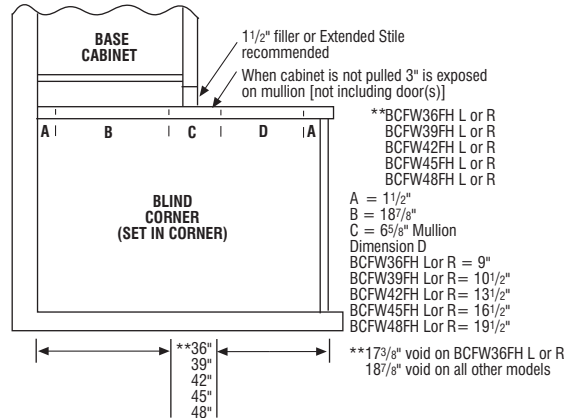

Top View

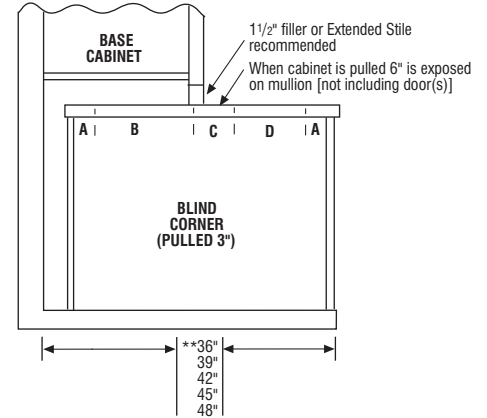

Top View, Pulled 3"

Door & Drawer Options

AF	AOMBWB	CC	CG	GAMD	IFHG	MD	PRMD	PTOWB	SHMD	SPLITDR	SPLITDRWS	TCP
			✓	✓			✓	✓		✓		

End Panel Options

AUTH	CSFPE	EXBK	FFD	FL/FR	FPE	INTGE	IPE
✓	✓	✓	✓	✓	✓	✓	✓

Custom Modification Options

ADD_SHLF	ADDTK	CBO	CCO	CFNT0	CFP	CFRMO	CHGDRW	CLIP	CMAT	CND	CSDGBK	DRT	DRWSEC	DRWTK	EX	EX	EX	FBFL	FD
															✓	✓	✓	✓	✓
FDSRTBTM	FLUT ¹	FTK	ID	IH	INVFRM	IW	LIGHT	MIP	OBRB	PFINBTMB	RD	RECTK	RECTK_6	RECTKERT6	RH	ROSFLUT	RT		
		✓	✓	✓			✓	✓	✓		✓	✓	✓	✓	✓	✓	✓		
RW	SBCADDY	SBCADDYSM	SCPDRW	SRT	STW	TD	TKP	TVR	UDBX	URT	VTK	WS ²	WTCD	WTKCUP	WTR				
								✓				✓			✓				

¹ Fluting both 6" not available.

² Not available with wide stile both.

Base Corner Cabinets

FULL HEIGHT BASE CORNER FULL WIDTH with CURVE PULL-OUT, 34 1/2" HIGH, 24" DEEP

L G I X

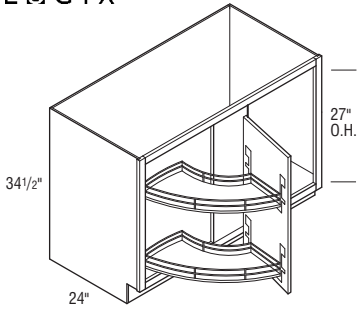

Cubic Feet	1	2	3	4	5	6	7	
BCFWFH48CRVPO L or R	27.3	3026	3108	3173	3280	3375	3568	3761

- Includes one 3" filler, shipped unattached.
- Pull-out features two chrome and wood curve shaped shelves.
- 60 lb. weight capacity per shelf.
- Door is attached to top and bottom shelves of pull-out.
- Can be pulled 3".
- Pull-out features Smart Stop slides.
- Not available on Inset or Beaded Inset Styles.

Door & Drawer Options

AF	AOMBWB	CC	CG	GAMD	IFHG	MD	PRMD	PTOWB	SHMD	SPLITDR	SPLITDRWS	TCP
			✓	✓		✓	✓		✓			

End Panel Options

AUTH	CSFPE	EXBK	FFD	FL/FR	FPE	INTGE	IPE
✓	✓	✓	✓	✓	✓	✓	✓

Custom Modification Options

ADD	SHLF	ADDTK	CBO	CCO	CFNTO	CFP	CFRMO	CHGDRW	CLIP	CMAT	CND	CSDGBK	DRT	DRWSEC	DRWTK	EX	EX_OL	FBFL	FD
			✓	✓	✓		✓				✓	✓			✓	✓	✓	✓	✓

FDSRTBTM	FLUT	FTK	ID	IH	INVFRM	IW	LIGHT	MIP	OBRB	PFINBTMB	RD	RECTK	RECTK_6	RECTKFRT6	RH	ROSFLUT	RT
	✓	✓					✓	✓			✓	✓	✓	✓		✓	

RW	SBCADDY	SBCADDYSM	SCPDWR	SRT	STW	TD	TKP	TVR	UDBX	URT	VTK	WS	WTCO	WTKCUP	WTR
												✓			✓

TWO DRAWER BASE CORNER FULL WIDTH with CURVE PULL-OUT, 34 1/2" HIGH, 24" DEEP

L G I X

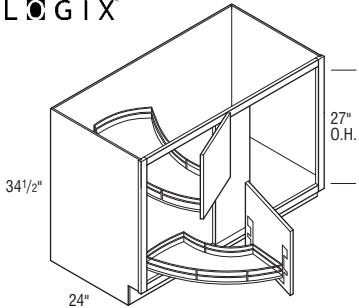

Cubic Feet	1	2	3	4	5	6	7	
BCFW2D48CRVPO L or R	27.3	3626	3708	3773	3880	3975	4168	4361

- Includes one 3" filler, shipped unattached.
- Pull-out features two chrome and wood curve shaped shelves.
- 60 lb. weight capacity per shelf.
- Pull-out shelves are attached to the drawer fronts. Each drawer front opens independently.
- Can be pulled 3".
- Pull-out features Smart Stop slides.
- Not available on Inset or Beaded Inset Styles.

Door & Drawer Options

AF	AOMBWB	CC	CG	GAMD	IFHG	MD	PRMD	PTOWB	SHMD	SPLITDR	SPLITDRWS	TCP
			✓	✓		✓	✓		✓			

End Panel Options

AUTH	CSFPE	EXBK	FFD	FL/FR	FPE	INTGE	IPE
✓	✓	✓	✓	✓	✓	✓	✓

Custom Modification Options

ADD	SHLF	ADDTK	CBO	CCO	CFNTO	CFP	CFRMO	CHGDRW	CLIP	CMAT	CND	CSDGBK	DRT	DRWSEC	DRWTK	EX	EX_OL	FBFL	FD
			✓	✓	✓		✓				✓	✓			✓	✓	✓	✓	✓

FDSRTBTM	FLUT	FTK	ID	IH	INVFRM	IW	LIGHT	MIP	OBRB	PFINBTMB	RD	RECTK	RECTK_6	RECTKFRT6	RH	ROSFLUT	RT
	✓	✓					✓	✓			✓	✓	✓	✓		✓	

RW	SBCADDY	SBCADDYSM	SCPDWR	SRT	STW	TD	TKP	TVR	UDBX	URT	VTK	WS	WTCO	WTKCUP	WTR
												✓			✓

IH/RH availability charts starting on page G-40.
IW/RW availability charts starting on page G-46.

BASE CORNER FULL WIDTH PENINSULA, 34 1/2" HIGH, 24" DEEP

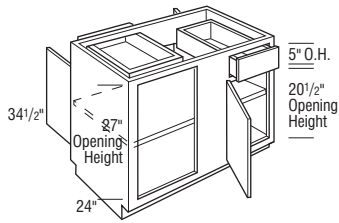

Left Shown

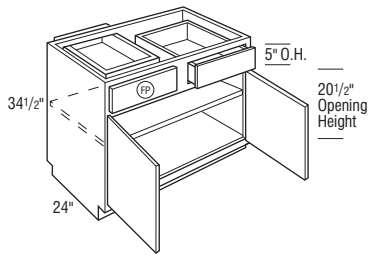

Peninsula Side Shown

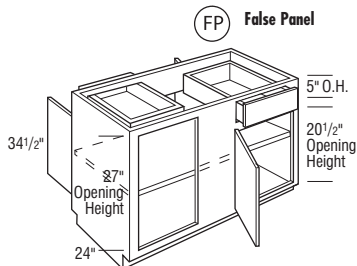

BCFW48P L or R
Left Shown

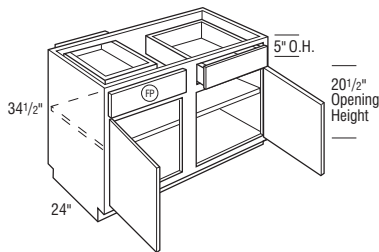

BCFW48P L or R
Peninsula Side Shown

(FP) False Panel

Cubic Feet	1	2	3	4	5	6	7	
BCFW39P L or R	22.4	2671	2792	2893	3048	3195	3485	3775
BCFW42P L or R	24.0	2727	2854	2960	3106	3276	3564	3852
BCFW48P L or R	27.3	2972	3112	3224	3394	3559	3877	4195

Notes below apply to all products in section above:

- Includes two 3" fillers, shipped unattached.
- Specify location of modification for front or peninsula side.
- One adjustable Full Depth Shelf.
- Door will be hinged on same side as blind.
- Peninsula side with one cabinet false panel and one drawer.
- Use of filler or Extended Stile is required for full overlay doors to operate properly.
- Reduced Depths available in 1/4" increments from 12" to 23 3/4".

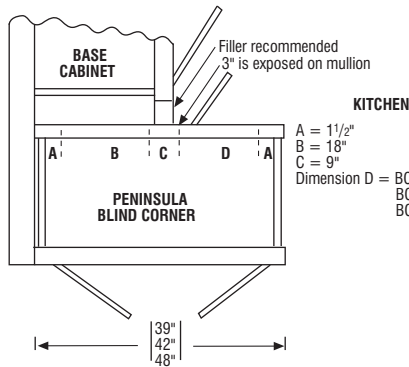

Top View

Door & Drawer Options

AF	AOMBWB	CC	CG	GAMD	IFHG	MD	PRMD	PTOWB	SHMD	SPLITDR	SPLITDRWS	TCP

End Panel Options

AUTH	CSFPE	EXBK	FFD	FL/FR	FPE	INTGE	IPE

Custom Modification Options

ADD	SHLF	ADDTK	CBO	CCO	CFNTD	CFP	CFRMO	CHGDRW	CLIP	CMAT	CND	CSDGBK	DRT	DRWSEC	DRWTK	EX	OL	FBFL	FD
FDSRTBTM	FLUT ¹	FTK	ID	IH	INVFRM	IW	LIGHT	MIP	OBRB	PFINBTMB	RD	RECTK	RECTK_6	RECTKERT6	RH	ROSLUT	RT		
RW	SBCADDY	SBCADDYSM	SCPDRW	SRT	STW	TD	TKP	TVR	UDBX	URT	VTK	WS ²	WTCD	WTKCUP	WTR				

¹ 6" fluting not available on 39" or 42" wide.

² Not available with wide stile both.

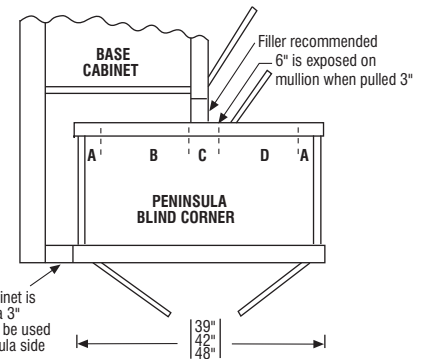

Top View, Pulled 3"

Base Lazy Susan & Corner Sink Base Cabinets

	Cubic Feet	1	2	3	4	5	6	7	
BASE LAZY SUSAN, 34 1/2" HIGH	BLS33 L or R	12.9	2482	2606	2697	2843	3009	3288	3567

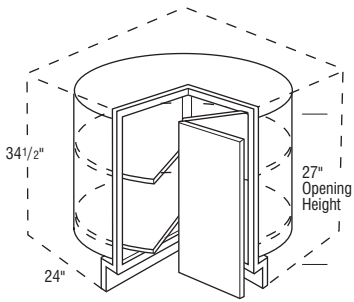

• Wood pan size is 18".

BLS36 L or R	19.1	2501	2619	2713	2859	3030	3310	3590
---------------------	------	------	------	------	------	------	------	------

• Wood Pan size is 24".

Notes below apply to all products in section above:

- Not available on Inset and Beaded Inset styles.
- Use Lazy Susan Base End Panel panel for end application.
- Doors are connected with bifold hinge.

Door & Drawer Options

AF	AOMBWB	CC	CG	GAMD	IFHG	MD	PRMD	PTOWB	SHMD	SPLITDR	SPLITDRWS	TCP
----	--------	----	----	------	------	----	------	-------	------	---------	-----------	-----

End Panel Options

AUTH	CSFPE	EXBK	FFD	FL/FR	FPE	INTGE	IPE
------	-------	------	-----	-------	-----	-------	-----

Custom Modification Options

ADD	SHLF	ADDTK	CBO	CCO	CFNTO	CFP	CFRMO	CHGDRW	CLIP	CMAT	CND	CSDGBK	DRT	DRWSEC	DRWTK	EX	EX_OL	FBFL	FD
-----	------	-------	-----	-----	-------	-----	-------	--------	------	------	-----	--------	-----	--------	-------	----	-------	------	----

FDSRTBTM	FLUT ¹	FTK ²	ID	IH	INVFRM	IW	LIGHT	MIP	OBRB	PFINBTMB	RD	RECTK	RECTK_6	RECTKFRT6	RH	ROSLUT	RT
----------	-------------------	------------------	----	----	--------	----	-------	-----	------	----------	----	-------	---------	-----------	----	--------	----

RW	SBCADDY	SBCADDYSM	SCPDRW	SRT	STW	TD	TKP	TVR	UBX	URT	VTK	WS	WTCO	WTKCUP	WTR
----	---------	-----------	--------	-----	-----	----	-----	-----	-----	-----	-----	----	------	--------	-----

¹ Not available with 6" fluting.

² Not available with FTKAV and style B-L.

CORNER SINK BASE without SHELF, 34 1/2" HIGH, 24" DEEP

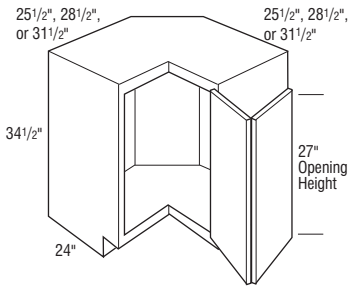

CS36 L or R	30.1	2373	2481	2572	2710	2850	3106	3362
--------------------	------	------	------	------	------	------	------	------

CS39 L or R	33.0	3085	3225	3344	3523	3705	4038	4371
--------------------	------	------	------	------	------	------	------	------

CS42 L or R	35.9	3239	3386	3511	3699	3890	4240	4590
--------------------	------	------	------	------	------	------	------	------

• Doors are connected with a bifold hinge.

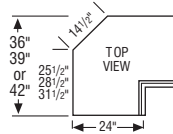

Door & Drawer Options

AF	AOMBWB	CC	CG	GAMD	IFHG	MD	PRMD	PTOWB	SHMD	SPLITDR	SPLITDRWS	TCP
----	--------	----	----	------	------	----	------	-------	------	---------	-----------	-----

End Panel Options

AUTH	CSFPE	EXBK	FFD	FL/FR	FPE	INTGE	IPE
------	-------	------	-----	-------	-----	-------	-----

Custom Modification Options

ADD	SHLF	ADDTK	CBO	CCO	CFNTO	CFP	CFRMO	CHGDRW	CLIP	CMAT	CND	CSDGBK	DRT	DRWSEC	DRWTK	EX	EX_OL	FBFL	FD
-----	------	-------	-----	-----	-------	-----	-------	--------	------	------	-----	--------	-----	--------	-------	----	-------	------	----

FDSRTBTM	FLUT ¹	FTK ²	ID	IH	INVFRM	IW	LIGHT	MIP	OBRB	PFINBTMB	RD	RECTK	RECTK_6	RECTKFRT6	RH	ROSLUT	RT
----------	-------------------	------------------	----	----	--------	----	-------	-----	------	----------	----	-------	---------	-----------	----	--------	----

RW	SBCADDY	SBCADDYSM	SCPDRW	SRT	STW	TD	TKP	TVR	UBX	URT	VTK	WS	WTCO	WTKCUP	WTR
----	---------	-----------	--------	-----	-----	----	-----	-----	-----	-----	-----	----	------	--------	-----

¹ Not available with 6" fluting.

² Not available with FTKAV and style B-L.

IH/RH availability charts starting on page G•40.
IW/RW availability charts starting on page G•46.

Asymmetrical Base Easy Reach & Diagonal Corner Sink Base Cabinets

ASYMMETRICAL BASE EASY REACH, 34 1/2" HIGH

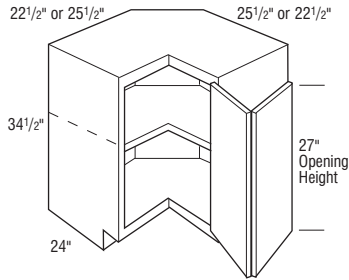

Cubic Feet	1	2	3	4	5	6	7	
BER3336 L or R	30.1	2904	3048	3149	3320	3502	3816	4130
BER3633 L or R	30.1	2904	3048	3149	3320	3502	3816	4130

- Units include one fixed shelf.
- Doors are connected with a bifold hinge.

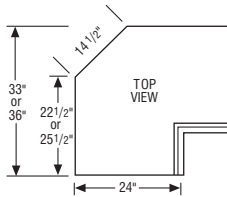

Door & Drawer Options

AF	AOMBWB	CC	CG	GAMD	IFHG	MD	PRMD	PTOWB	SHMD	SPLITDR	SPLITDRWS	TCP

End Panel Options

AUTH	CSFPE	EXBK	FFD	FL/FR	FPE	INTGE	IPE

Custom Modification Options

ADD_SHLF	ADDTK	CBO	CCO	CFNTO	CFP	CFRMO	CHGDRW	CLIP	CMAT	CND	CSDGBK	DRT	DRWSEC	DRWTK	EX	EX_OL	FBFL	FD

FDSRTBTM	FLUT ¹	FTK ²	ID	IH	INVFRM	IW	LIGHT	MIP	OBRB	PFINBTMB	RD	RECTK	RECTK_6	RECTKFR6	RH	ROSFLUT	RT

RW	SBCADDY	SBCADDYSM	SCPDRW	SRT	STW	TD	TKP	TVR	UDBX	URT	VTK	WS	WTCB	WTKCUP	WTR

¹ Not available with 6" fluting.

² Not available with FTKAV and style B-L.

DIAGONAL CORNER SINK BASE without SHELF, 34 1/2" HIGH, 24" DEEP

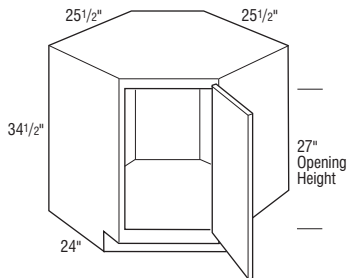

Cubic Feet	1	2	3	4	5	6	7	
DAB36 L or R	30.1	2537	2661	2753	2908	3068	3357	3646

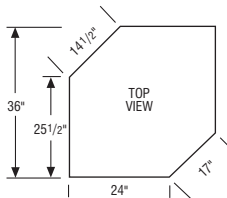

Door & Drawer Options

AF	AOMBWB	CC	CG	GAMD	IFHG	MD	PRMD	PTOWB	SHMD	SPLITDR	SPLITDRWS	TCP

End Panel Options

AUTH	CSFPE	EXBK	FFD	FL/FR	FPE	INTGE	IPE

Custom Modification Options

ADD_SHLF	ADDTK	CBO	CCO	CFNTO	CFP	CFRMO	CHGDRW	CLIP	CMAT	CND	CSDGBK	DRT	DRWSEC	DRWTK	EX	EX_OL ¹	FBFL	FD

FDSRTBTM	FLUT	FTK	ID	IH	INVFRM	IW	LIGHT	MIP	OBRB	PFINBTMB	RD	RECTK	RECTK_6	RECTKFR6	RH	ROSFLUT	RT

RW	SBCADDY	SBCADDYSM	SCPDRW	SRT	STW	TD	TKP	TVR	UDBX	URT	VTK	WS	WTCB	WTKCUP	WTR

¹ Only available on extended stile both.

Diagonal Base & Base Easy Reach Cabinets

	Cubic Feet	1	2	3	4	5	6	7
DIAGONAL BASE with FULL SHELF, 34 1/2" HIGH, 24" DEEP								
DAB33FS L or R	25.5	2594	2719	2816	2968	3143	3433	3723
DAB36FS L or R	30.1	2720	2854	2961	3117	3281	3588	3895

• Units include one fixed shelf.

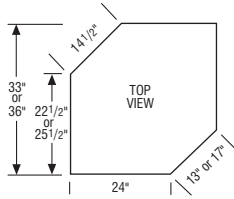
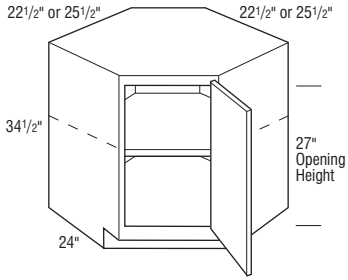

Door & Drawer Options

AF	AOMBWB	CC	CG	GAMD	IFHG	MD	PRMD ¹	PTOWB	SHMD	SPLITDR	SPLITDRWS	TCP
		✓	✓	✓	✓	✓	✓		✓			

End Panel Options

AUTH	CSFPE	EXBK	FFD	FL/FR	FPE	INTGE	IPE
✓	✓	✓	✓	✓	✓	✓	✓

Custom Modification Options

ADD_SHLF	ADDTK	CBO	CCO	CFNTD	CFP	CFRMO	CHGDRW	CLIP	CMAT	CND	CSDGBK	DRT	DRWSEC	DRWTK	EX	EX_OL ²	FBFL	FD
		✓	✓	✓	✓	✓				✓								✓
FDSRTBTM	FLUT	FTK	ID	IH	INVFRM	IW	LIGHT	MIP	OBRB	PFINBTMB	RD	RECTK	RECTK_6	RECTKFRT6	RH	ROSLUT	RT	
✓	✓	✓	✓	✓	✓	✓	✓	✓	✓			✓			✓	✓		
RW	SBCADDY	SBCADDYSM	SCPDRW	SRT	STW	TD	TKP	TVR ³	UDBX	URT	VTK	WS	WTCB	WTKCUP	WTR			
								✓	✓		✓				✓			

¹ Not available on 33" wide.

² Only available on extended stile both.

³ TVRAV and style B-L not available on 33" wide.

BASE EASY REACH, 34 1/2" HIGH, 24" DEEP

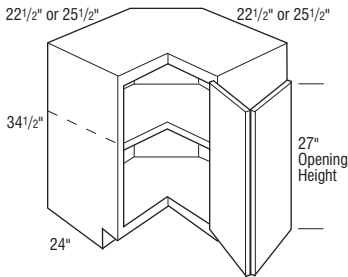

	Cubic Feet	1	2	3	4	5	6	7
BER33 L or R	25.5	2526	2651	2738	2887	3046	3318	3590
BER36 L or R	30.1	2526	2651	2738	2887	3046	3318	3590

- Includes one fixed shelf.
- Doors are connected with bifold hinge.

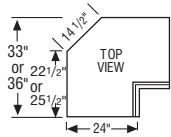

Door & Drawer Options

AF	AOMBWB	CC	CG	GAMD	IFHG	MD	PRMD	PTOWB	SHMD	SPLITDR	SPLITDRWS	TCP
				✓								

End Panel Options

AUTH	CSFPE	EXBK	FFD	FL/FR	FPE	INTGE	IPE
✓	✓	✓	✓	✓	✓	✓	✓

Custom Modification Options

ADD_SHLF	ADDTK	CBO	CCO	CFNTD	CFP	CFRMO	CHGDRW	CLIP	CMAT	CND	CSDGBK	DRT	DRWSEC	DRWTK	EX	EX_OL	FBFL	FD
			✓	✓						✓							✓	✓
FDSRTBTM	FLUT	FTK	ID	IH	INVFRM	IW	LIGHT	MIP	OBRB	PFINBTMB	RD	RECTK	RECTK_6	RECTKFRT6	RH	ROSLUT	RT	
✓	✓	✓	✓	✓	✓	✓	✓	✓	✓			✓			✓	✓		
RW	SBCADDY	SBCADDYSM	SCPDRW	SRT	STW	TD	TKP	TVR	UDBX	URT	VTK	WS	WTCB	WTKCUP	WTR			
								✓	✓		✓				✓			

IH/RH availability charts starting on page G-40.
IW/RW availability charts starting on page G-46.

BASE EASY REACH with REDUCED SHELF, 34 1/2" HIGH, 24" DEEP

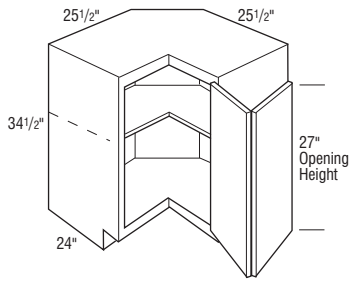

BER36RS L or R

- Doors are connected with a bifold hinge.
- Unit includes one fixed shelf.
- Fixed shelf reduced 3".

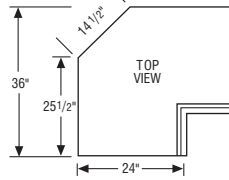

Cubic Feet	1	2	3	4	5	6	7
30.1	2526	2651	2738	2887	3046	3318	3590

Door & Drawer Options

AF	AOMBWB	CC	CG	GAMD	IFHG	MD	PRMD	PTOWB	SHMD	SPLITDR	SPLITDRWS	TCP
						✓						

End Panel Options

AUTH	CSFPE	EXBK	FFD	FL/FR	FPE	INTGE	IPE
✓	✓	✓		✓	✓		

Custom Modification Options

ADD_SHLF	ADDTK	CBO	CCO	CFNTO	CFP	CFRMO	CHGDRW	CLIP	CMAT	CND	CSDGBK	DRT	DRWSEC	DRWTK	EX	EX_OL	FBFL	FD	
			✓	✓						✓						✓	✓		

FDSRTBTM	FLUT ¹	FTK ²	ID	IH	INVFRM	IW	LIGHT	MIP	OBRB	PFINBTMB	RD	RECTK	RECTK_6	RECTKFT6	RH	ROSFLUT	RT
	✓	✓	✓				✓	✓				✓			✓	✓	

RW	SBCADDY	SBCADDYSM	SCPDRW	SRT	STW	TD	TKP	TVR	UDBX	URT	VTK	WS	WTC	WTKCUP	WTR
									✓		✓				✓

¹ Not available with 6" fluting.

² Not available with FTKAV and style B-L.

Super Lazy Susan Cabinets

SUPER LAZY SUSAN with CHROME RAIL and REDUCED SHELF, 34 1/2" HIGH

L G I X

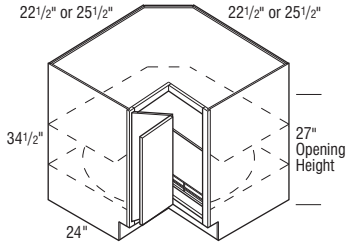

Cubic Feet	1	2	3	4	5	6	7	
SLSCR33RS L or R	25.5	3096	3248	3362	3545	3756	4103	4450
SLSCR36RS L or R	30.1	3181	3334	3451	3639	3854	4208	4562

- Tray diameter is 28".
- Not available on Inset and Beaded Inset styles.

- Tray diameter is 32".

Notes below apply to all products in section above:

- Doors are connected with a bifold hinge.
- Unit includes chrome rail Lazy Susan on bottom and a reduced fixed shelf on top.
- Fixed shelf is reduced 3".

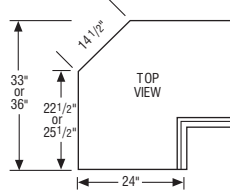

Door & Drawer Options

AF	AOMBWB	CC	CG	GAMD	IFHG ¹	MD	PRMD	PTOWB	SHMD	SPLITDR	SPLITDRWS	TCP
					✓							

End Panel Options

AUTH	CSFPE	EXBK	FFD	FL/FR	FPE	INTGE	IPE
✓	✓	✓		✓	✓		✓

Custom Modification Options

ADD_SHLF	ADDTK	CBO	CCO	CFNTO	CFP	CFRMO	CHGDRW	CLIP	CMAT	CND	CSDGBK	DRT	DRWSEC	DRWTK	EX	EX_OL	FBFL	FD	
			✓							✓						✓	✓		

FDSRTBTM	FLUT ²	FTK ³	ID	IH	INVFRM	IW	LIGHT	MIP	OBRB	PFINBTMB	RD	RECTK	RECTK_6	RECTKFRT6	RH	ROSLUT	RT
	✓	✓		✓				✓				✓			✓	✓	

RW	SBCADDY	SBCADDYSM	SCPDRW	SRT	STW	TD	TKP	TVR	UDBX	URT	VTK	WS	WTCO	WTKCUP	WTR
								✓			✓				✓

¹ Not available on 33" wide.

² Not available with 6" fluting.

³ Not available with FTKAV and style B-L.

IH/RH availability charts starting on page G-40.
IW/RW availability charts starting on page G-46.

BASE EASY REACH with LAZY SUSAN and DIAGONAL BASE with FULL HEIGHT DOOR and LAZY SUSAN, 34 1/2" HIGH, 24" DEEP

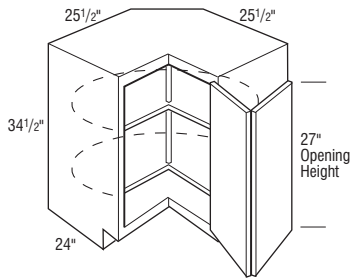

BER365 L or R

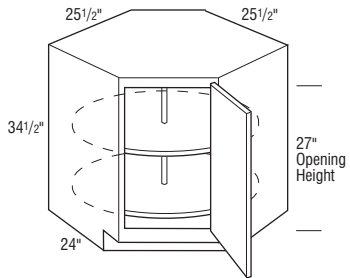

DAB365 L or R

Cubic Feet	1	2	3	4	5	6	7	
BER365 L or R	30.1	3034	3181	3292	3472	3677	4018	4359

- Doors are connected with a bifold hinge.
- Pan diameter is 28".

DAB365 L or R	30.1	3260	3419	3537	3730	3951	4315	4679
----------------------	------	------	------	------	------	------	------	------

- Wood pans are adjustable and rotate individually.
- Pan diameter is 28".

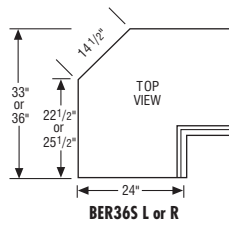

BER365 L or R

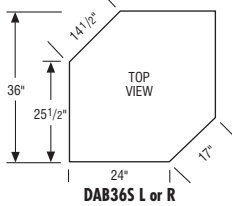

DAB365 L or R

Door & Drawer Options

AF	AOMBWB	CC	CG ¹	GAMD ¹	IFHG	MD ¹	PRMD ¹	PTOWB	SHMD ¹	SPLITDR	SPLITDRWS	TCP
			✓	✓	✓	✓	✓		✓			

End Panel Options

AUTH	CSFPE	EXBK	FFD ¹	FL/FR	FPE	INTGE ¹	IPE
✓	✓	✓	✓	✓	✓	✓	✓

Custom Modification Options

ADD_SHLF	ADDTK	CBO	CCO	CFNTO ¹	CFP	CFRMO ¹	CHGDRW	CLIP	CMAT	CND	CSDGBK	DRT	DRWSEC	DRWTK	EX ²	EX_OL ²	FBFL	FD
				✓		✓				✓					✓	✓		
FDSRTBTM	FLUT ³	FTK ⁴	ID	IH	INVFRM	IW	LIGHT ¹	MIP	OBRB	PFINBTMB	RD	RECTK	RECTK_6	RECTKFR6	RH	ROSFLUT ²	RT	
	✓	✓					✓	✓				✓				✓		
RW	SBCADDY	SBCADDYSM	SCPDRW	SRT	STW	TD	TKP	TVR ¹	UDBX	URT	VTK	WS	WTCD	WTKCUP	WTR			
								✓	✓		✓				✓			

¹ Not available on BER365 L or R version.

² Not available on DAB365 L or R version.

³ Not available on DAB365 L or R version. Not available with 6" fluting.

⁴ FTKAV and style B-L not available with BER365 L or R version.

Super Lazy Susan Cabinets

SUPER LAZY SUSAN, 34 1/2" HIGH

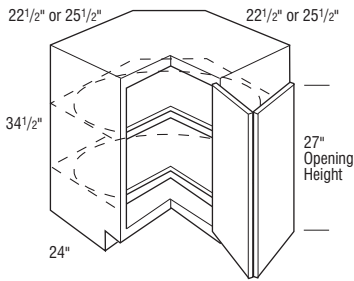

	Cubic Feet	1	2	3	4	5	6	7
SLSW3336 L or R	25.5	4002	4196	4345	4581	4854	5298	5742
SLSW3633 L or R	25.5	4002	4196	4345	4581	4854	5298	5742
SLSW33 L or R	30.1	3480	3649	3778	3983	4221	4607	4993
SLSW36 L or R	30.1	3695	3875	4013	4228	4480	4892	5304

• Pan diameter is 28".

• Pan diameter is 32".

Notes below apply to all products in section above:

- Doors are connected with a bifold hinge.
- 33" wide not available on Inset or Beaded Inset styles.

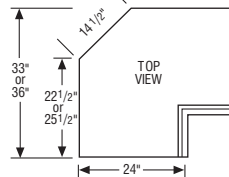

Door & Drawer Options

AF	AOMBWB	CC	CG	GAMD	IFHG ¹	MD	PRMD	PTOWB	SHMD	SPLITDR	SPLITDRWS	TCP
					✓							

End Panel Options

AUTH	CSFPE	EXBK ²	FFD	FL/FR	FPE	INTGE	IPE
✓	✓	✓		✓	✓		

Custom Modification Options

ADD	SHLF	ADDTK	CBO	CCO	CFNTO	CFP	CFRMO	CHGDRW	CLIP	CMAT	CND	CSDGBK	DRT	DRWSEC	DRWTK	EX	EX_OL	FBFL	FD
											✓				✓	✓			

FDSRTBTM	FLUT ³	FTK ⁴	ID	IH	INVFRM	IW	LIGHT	MIP	OBRB	PFINBTMB	RD	RECTK	RECTK_6	RECTKFRT6	RH	ROSLUT	RT
	✓	✓	✓					✓				✓			✓	✓	

RW	SBCADDY	SBCADDYSM	SCPDRW	SRT	STW	TD	TKP	TVR	UDBX	URT	VTK	WS	WTCD	WTKCUP	WTR
											✓				✓

¹ Not available with SLSW**** L or R versions.

² Not available on 36" wide.

³ Not available with 6" fluting.

⁴ Not available with FTKAV and style B-L.

IH/RH availability charts starting on page G-40.
IW/RW availability charts starting on page G-46.

Super Lazy Susan Cabinets

DIAGONAL BASE with FULL HEIGHT DOOR and SUPER LAZY SUSAN, 34 1/2" HIGH, 24" DEEP

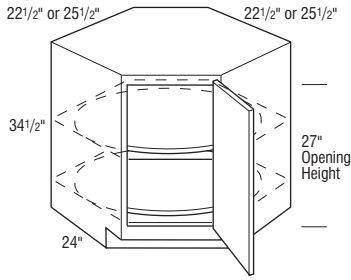

Cubic Feet	1	2	3	4	5	6	7	
DAB33SLS L or R	25.5	3783	3966	4105	4329	4584	5007	5430
DAB36SLS L or R	30.1	4019	4212	4359	4597	4870	5318	5766

• Tray diameter is 28".

• Tray diameter is 32".

Notes below apply to all products in section above:

- Wood Pans attached to fixed shelf, do rotate individually.
- Recommend hinging on the larger side on bifold units.

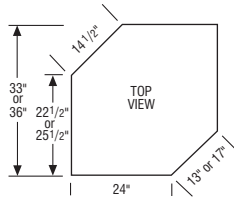

Door & Drawer Options

AF	AOMBWB	CC	CG	GAMD	IFHG	MD	PRMD	PTOWB	SHMD	SPLITDR	SPLITDRWS	TCP
		✓	✓	✓	✓	✓	✓	✓	✓			

End Panel Options

AUTH	CSFPE	EXBK	FFD	FL/FR	FPE	INTGE	IPE
✓	✓	✓	✓	✓	✓	✓	✓

Custom Modification Options

ADD_SHLF	ADDTK	CBO	CCO	CFNTO	CFP	CFRMO	CHGDRW	CLIP	CMAT	CND	CSDGBK	DRT	DRWSEC	DRWTK	EX	EX_OL	FBFL	FD
		✓	✓	✓		✓				✓					✓			

FDSRTBTM	FLUT	FTK ¹	ID	IH	INVFRM	IW	LIGHT	MIP	OBRB	PFINBTMB	RD	RECTK	RECTK_6	RECTKFRT6	RH	ROSFLUT	RT
		✓	✓	✓	✓	✓	✓	✓				✓			✓		

RW	SBCADDY	SBCADDYSM	SCPDRW	SRT	STW	TD	TKP	TVR	UDBX	URT	VTK	WS	WTCO	WTKCUP	WTR
									✓	✓	✓				✓

¹ FTKAV and style B-L not available on 33" wide.

Super Lazy Susan Cabinets

SUPER LAZY SUSAN with CHROME RAIL, 34 1/2" HIGH L O G I X

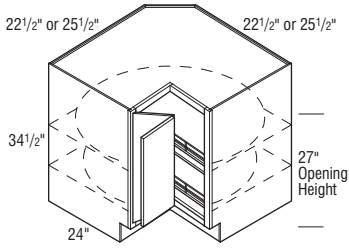

	Cubic Feet	1	2	3	4	5	6	7
SLS3336 L or R	25.5	5186	5441	5631	5938	6290	6868	7446
SLS3633 L or R	25.5	5186	5441	5631	5938	6290	6868	7446
• Tray diameter is 28".								
SLS33 L or R	25.5	4510	4731	4896	5163	5469	5973	6477
SLS36 L or R	30.1	4650	4878	5047	5327	5640	6156	6672
• Tray diameter is 32".								

Notes below apply to all products in section above:

- Doors are connected with a bifold hinge.
- Wood Pans attached to fixed shelf, do rotate individually.
- 33" wide not available on Inset or Beaded Inset styles.

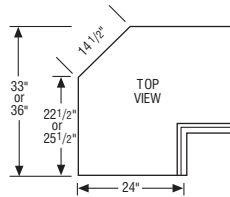

Door & Drawer Options

AF	AOMBWB	CC	CG	GAMD	IFHG ¹	MD	PRMD	PTOWB	SHMD	SPLITDR	SPLITDRWS	TCP
					✓							

End Panel Options

AUTH	CSFPE	EXBK	FFD	FL/FR	FPE	INTGE	IPE
✓	✓	✓		✓	✓		

Custom Modification Options

ADD	SHLF	ADDTK	CBO	CCO	CFNT0	CFP	CFRMO	CHGDRW	CLIP	CMAT	CND	CSDGBK	DRT	DRWSEC	DRWTK	EX	EX	OL	FBFL	FD
			✓								✓					✓	✓			
FDSRTBTM	FLUT ²	FTK ³	ID	IH	INVFRM	IW	LIGHT	MIP	OBRB	PFINBTMB	RD	RECTK	RECTK_6	RECTKFRT6	RH	ROSLUT	RT			
	✓	✓	✓					✓			✓				✓	✓				
RW	SBCADDY	SBCADDYSM	SCPDW	SRT	STW	TD	TKP	TVR	UDBX	URT	VTK	WS	WTCO	WTKCUP	WTR					
							✓				✓				✓					

¹ Not available with SLS33**** L or R versions or 33" wide.

² Not available with 6" fluting.

³ Not available with FTKAV and style B-L.

IH/RH availability charts starting on page G-40.
IW/RW availability charts starting on page G-46.

Super Lazy Susan & Base Rotating Deep Bin Cabinets

SUPER LAZY SUSAN with CHROME RAIL and CORNER DRAWER, 34 1/2" HIGH L G I X

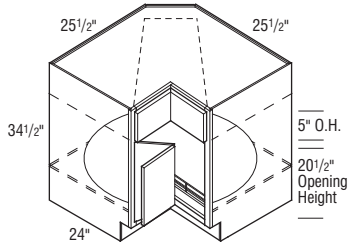

SLSCR36CD L or R

Cubic Feet	1	2	3	4	5	6	7	
	30.1	5104	5350	5539	5841	6185	6757	7329

- Doors are connected with a bifold hinge.
- Tray diameter is 32".
- Allow for proper clearance of drawer head when specifying corner drawer cabinets next to appliances.
- Will have 1" of exposed frame rail so drawer fronts will clear doors and drawer front of adjacent cabinets.
- Not available on Inset and Beaded Inset styles.

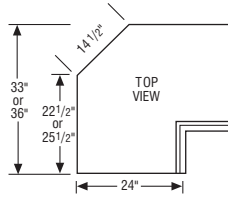

Door & Drawer Options

AF	AOMBWB	CC	CG	GAMD	IFHG	MD	PRMD	PTOWB	SHMD	SPLITDR	SPLITDRWS	TCP
----	--------	----	----	------	------	----	------	-------	------	---------	-----------	-----

End Panel Options

AUTH	CSFPE	EXBK	FFD	FL/FR	FPE	INTGE	IPE
------	-------	------	-----	-------	-----	-------	-----

Custom Modification Options

ADD_SHLF	ADDTK	CBO	CCO	CFNTD	CFP	CFRMO	CHGDRW	CLIP	CMAT	CND	CSDGBK	DRT	DRWSEC	DRWTK	EX	EX_OL	FBFL	FD
----------	-------	-----	-----	-------	-----	-------	--------	------	------	-----	--------	-----	--------	-------	----	-------	------	----

FDSRTBTM	FLUT ¹	FTK ²	ID	IH	INVFRM	IW	LIGHT	MIP	OBRB	PFINBTMB	RD	RECTK	RECTK_6	RECTKFT6	RH	ROSFLUT	RT
----------	-------------------	------------------	----	----	--------	----	-------	-----	------	----------	----	-------	---------	----------	----	---------	----

RW	SBCADDY	SBCADDYSM	SCPDRW	SRT	STW	TD	TKP	TVR	UDBX	URT	VTK	WS	WTCU	WTKCUP	WTR
----	---------	-----------	--------	-----	-----	----	-----	-----	------	-----	-----	----	------	--------	-----

¹ Not available with 6" fluting.

² Not available with FTKAV and style B-L.

BASE ROTATING DEEP BIN, 36" WIDE L G I X

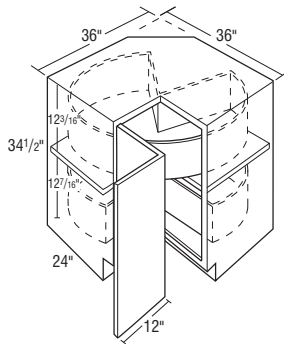

BRDB36 L or R

Cubic Feet	1	2	3	4	5	6	7	
	30.1	4194	4397	4553	4798	5084	5552	6020

- Doors are connected with a bifold hinge.
- BRDB36 L or R shelves are 30" diameter. Bins are 6" tall.
- Decorative hardware screws must be countersunk to prevent scratching of adjacent cabinets and face frame of BRDB.
- Integrated Smart Stop hinge not included.
- Inside bottom of lower deep susan to the fixed shelf is 12 7/16" high.
- Inside bottom of upper deep susan to the bottom of face frame cross rail is 12 3/16" high.

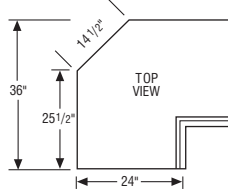

Door & Drawer Options

AF	AOMBWB	CC	CG	GAMD	IFHG	MD	PRMD	PTOWB	SHMD	SPLITDR	SPLITDRWS	TCP
----	--------	----	----	------	------	----	------	-------	------	---------	-----------	-----

End Panel Options

AUTH	CSFPE	EXBK	FFD	FL/FR	FPE	INTGE	IPE
------	-------	------	-----	-------	-----	-------	-----

Custom Modification Options

ADD_SHLF	ADDTK	CBO	CCO	CFNTD	CFP	CFRMO	CHGDRW	CLIP	CMAT	CND	CSDGBK	DRT	DRWSEC	DRWTK	EX	EX_OL	FBFL	FD
----------	-------	-----	-----	-------	-----	-------	--------	------	------	-----	--------	-----	--------	-------	----	-------	------	----

FDSRTBTM	FLUT ¹	FTK ²	ID	IH	INVFRM	IW	LIGHT	MIP	OBRB	PFINBTMB	RD	RECTK	RECTK_6	RECTKFT6	RH	ROSFLUT	RT
----------	-------------------	------------------	----	----	--------	----	-------	-----	------	----------	----	-------	---------	----------	----	---------	----

RW	SBCADDY	SBCADDYSM	SCPDRW	SRT	STW	TD	TKP	TVR	UDBX	URT	VTK	WS	WTCU	WTKCUP	WTR
----	---------	-----------	--------	-----	-----	----	-----	-----	------	-----	-----	----	------	--------	-----

¹ Not available with 6" fluting.

² Not available with FTKAV and style B-L.

Lazy Susan Pull-out & Three Corner Drawer Base Cabinets

	Cubic Feet	1	2	3	4	5	6	7	
LAZY SUSAN PULL-OUT, 34 1/2" HIGH, 36" WIDE	LSP36 L or R	20.8	4935	5163	5334	5611	5923	6444	6965

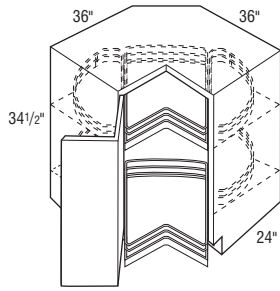

- Doors are connected with a bifold hinge.
- Roto diameter is 30".
- Rotos attached to fixed shelf and rotate individually.
- Each roto features two half-moon bins (8 3/8" x 25 1/2") with plywood shelves and chrome rail sides.
- Center pull-outs have Smart Stop guides and operate independently.

Door & Drawer Options

AF	AOMBWB	CC	CG	GAMD	IFHG	MD	PRMD	PTOWB	SHMD	SPLITDR	SPLITDRWS	TCP

End Panel Options

AUTH	CSFPE	EXBK	FFD	FL/FR	FPE	INTGE	IPE

Custom Modification Options

ADD_SHLF	ADDTK	CBO	CCO	CFNTO	CFP	CFRMO	CHGDRW	CLIP	CMAT	CND	CSDGBK	DRT	DRWSEC	DRWTK	EX	EX_OL	FBFL	FD	

FDSRTBTM	FLUT ¹	FTK ²	ID	IH	INVFRM	IW	LIGHT	MIP	OBRB	PFINBTMB	RD	RECTK	RECTK_6	RECTKFRT6	RH	ROSLUT	RT	

RW	SBCADDY	SBCADDYSM	SCPDRW	SRT	STW	TD	TKP	TVR	UDBX	URT	VTK	WS	WTCO	WTKCUP	WTR

¹ Not available with 6" fluting.
² Not available with FTKAV and style B-L.

THREE CORNER DRAWER BASE, 34 1/2" HIGH

L O G I X

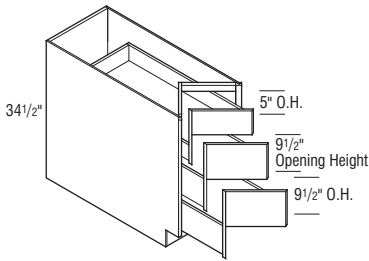

3CDB36	13.2	5049	5300	5478	5768	6087	6629	7171
---------------	------	------	------	------	------	------	------	------

- Must be installed between two cabinets.
- Allow for proper clearance of drawer head when specifying corner drawer cabinets next to appliances.
- Will have less than 3/4" overlay side reveal for clearance purposes.
- Not available on Inset and Beaded Inset styles.

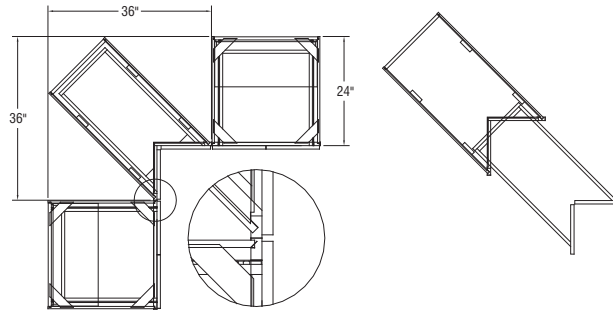

Door & Drawer Options

AF	AOMBWB	CC	CG	GAMD	IFHG	MD	PRMD	PTOWB	SHMD	SPLITDR	SPLITDRWS	TCP

End Panel Options

AUTH	CSFPE	EXBK	FFD	FL/FR	FPE	INTGE	IPE

Custom Modification Options

ADD_SHLF	ADDTK	CBO	CCO	CFNTO	CFP	CFRMO	CHGDRW	CLIP	CMAT	CND	CSDGBK	DRT	DRWSEC	DRWTK	EX	EX_OL ¹	FBFL	FD	

FDSRTBTM	FLUT	FTK ²	ID	IH	INVFRM	IW	LIGHT	MIP	OBRB	PFINBTMB	RD	RECTK	RECTK_6	RECTKFRT6	RH	ROSLUT	RT		

RW	SBCADDY	SBCADDYSM	SCPDRW	SRT	STW	TD	TKP	TVR	UDBX	URT	VTK	WS	WTCO	WTKCUP	WTR

¹ Only available on extended stile both.
² Not available with FTKAV and style B-L.

IH/RH availability charts starting on page G-40.
 IW/RW availability charts starting on page G-46.

Base Sliding Door Island Cabinets

BASE SLIDING DOOR ISLAND CABINET, 34 1/2" HIGH, 24" DEEP

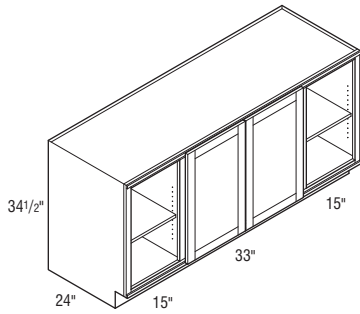
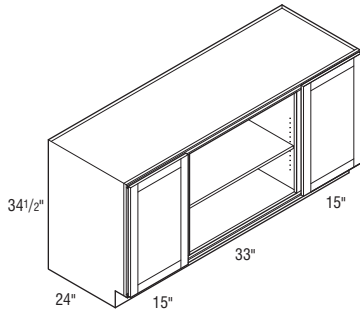

B72SDI

Cubic Feet	1	2	3	4	5	6	7
	40.6	4272	4483	4645	4903	5156	6110

- Cabinet has two Smart Stop Sliding Doors.
- Cabinet has one adjustable full depth shelf in each opening.
- Not available on Inset and Beaded Inset styles.
- Increased depth in 1/4" increments to 30".
- Reduced depth in 1/4" increments to 12".
- Outside openings 15" wide. Middle opening is 33" wide.
- Matching Interior is standard.
- Cabinet is not finished on the back, and would require a skin or panel to finish the back side if used for an island application.

Door & Drawer Options

AF	AOMBWB	CC	CG	GAMD	IFHG	MD	PRMD	PTOWB	SHMD	SPLITDR	SPLITDRWS	TCP
----	--------	----	----	------	------	----	------	-------	------	---------	-----------	-----

End Panel Options

AUTH	CSFPE	EXBK	FFD	FL/FR	FPE	INTGE	IPE
✓	✓	✓	✓	✓	✓	✓	✓

Custom Modification Options

ADD_SHLF	ADDTK	CBO	CCO	CFNTO	CFP	CFRMO	CHGDRW	CLIP	CMAT	CND	CSDGBK	DRT	DRWSEC	DRWTK	EX	EX_OL	FBFL	FD	
✓																			
FDSRTBTM	FLUT	FTK	ID	IH	INVFRM	IW	LIGHT	MIP	OBRB	PFINBTMB	RD	RECTK	RECTK_6	RECTKFR6	RH	ROSLUT	RT		
	✓	✓	✓	✓					✓		✓	✓	✓	✓	✓	✓	✓		
RW	SBCADDY	SBCADDYSM	SCPDRW	SRT	STW	TD	TKP	TVR	UDBX	URT	VTK	WS	WTC	WTKCUP	WTR				
							✓				✓								

BASE SLIDING DOOR ISLAND CABINET with SLIDING DESK, 34 1/2" HIGH, 24" DEEP

L G I X

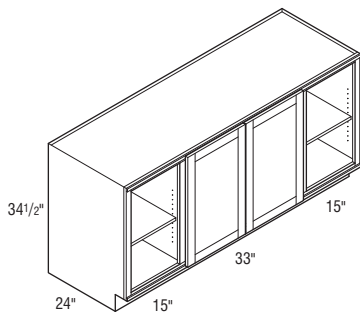
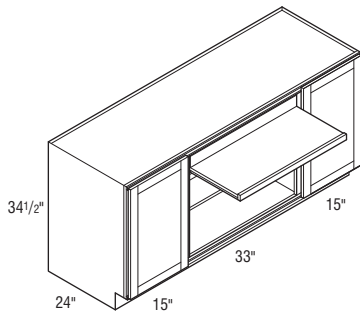

B72SDIDSK

Cubic Feet	1	2	3	4	5	6	7
	40.6	4409	4627	4794	5060	5319	6307

- Cabinet has two Smart Stop Sliding Doors.
- Cabinet has one adjustable full depth shelf in each opening.
- Center section will include a sliding desk with Smart Stop slides.
- Not available on Inset and Beaded Inset styles.
- Increased depth in 1/4" increments to 30".
- Outside openings 15" wide. Middle opening is 33" wide.
- Matching Interior is standard.
- Cabinet is not finished on the back, and would require a skin or panel to finish the back side if used for an island application.

Door & Drawer Options

AF	AOMBWB	CC	CG	GAMD	IFHG	MD	PRMD	PTOWB	SHMD	SPLITDR	SPLITDRWS	TCP
----	--------	----	----	------	------	----	------	-------	------	---------	-----------	-----

End Panel Options

AUTH	CSFPE	EXBK	FFD	FL/FR	FPE	INTGE	IPE
✓	✓	✓	✓	✓	✓	✓	✓

Custom Modification Options

ADD_SHLF	ADDTK	CBO	CCO	CFNTO	CFP	CFRMO	CHGDRW	CLIP	CMAT	CND	CSDGBK	DRT	DRWSEC	DRWTK	EX	EX_OL	FBFL	FD	
✓																			
FDSRTBTM	FLUT	FTK	ID	IH	INVFRM	IW	LIGHT	MIP	OBRB	PFINBTMB	RD	RECTK	RECTK_6	RECTKFR6	RH	ROSLUT	RT		
		✓	✓	✓					✓		✓	✓	✓	✓	✓	✓	✓		
RW	SBCADDY	SBCADDYSM	SCPDRW	SRT	STW	TD	TKP	TVR	UDBX	URT	VTK	WS	WTC	WTKCUP	WTR				
							✓				✓								

Base Peninsula Cabinets

BASE PENINSULA, 34 1/2" HIGH, 24" DEEP

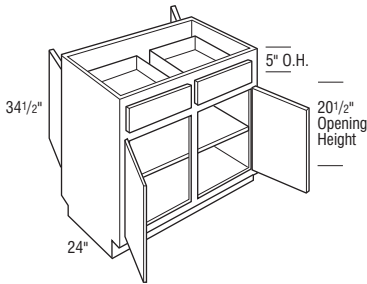
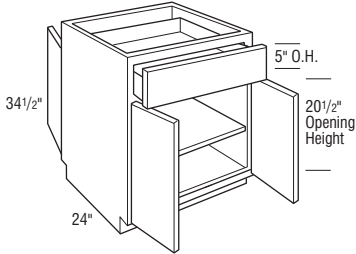
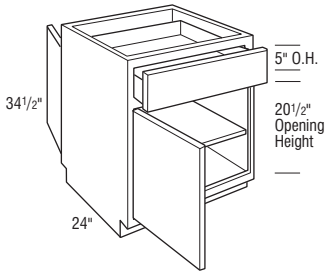

	Cubic Feet	1	2	3	4	5	6	7
B9P L or R	5.8	1699	1776	1838	1936	2045	2235	2425
B12P L or R	7.5	1728	1815	1876	1986	2090	2277	2464
B15P L or R	9.1	1802	1890	1954	2062	2175	2374	2573
B18P L or R	10.8	1862	1952	2027	2132	2248	2455	2662
B21P L or R	12.4	1936	2033	2107	2219	2336	2559	2782
B24P L or R	14.1	2010	2109	2187	2309	2430	2652	2874
B24P	14.1	2410	2524	2617	2753	2903	3171	3439
B27P	15.7	2785	2917	3025	3184	3355	3661	3967
B30P	17.4	2864	3002	3116	3277	3452	3770	4088
B33P	19.0	2912	3056	3166	3330	3515	3837	4159
B36P	20.7	2993	3139	3245	3427	3608	3948	4288
B39P	22.4	3064	3214	3326	3508	3695	4035	4375
B42P	24.0	3250	3414	3532	3730	3917	4286	4655
B45P	25.7	3397	3565	3693	3898	4090	4469	4848
B48P	27.3	3532	3703	3836	4046	4253	4643	5033

Notes below apply to all products in section above:

- One adjustable Full Depth Shelf.
- Peninsula back includes false drawer front and functional doors.
- Specify location of modification for front or peninsula side.
- Reduced Depths available in 1/4" increments from 12" to 23 3/4".
- Exceptions may apply when using IW with Wide stiles. Please reference these sections in Section G for more details.

Door & Drawer Options

AF	AOMBWB	CC	CG	GAMD	IFHG	MD	PRMD ¹	PTOWB	SHMD ²	SPLITDR ³	SPLITDRWS ⁴	TCP

End Panel Options

AUTH	CSFPE	EXBK	FFD	FL/FR ²	FPE	INTGE	IPE

Custom Modification Options

ADD	SHLF	ADDTK	CBO	CCO	CFNT0	CFP	CFRMO	CHGDRW	CLIP ⁵	CMAT	CND	CSDGBK	DRT	DRWSEC ⁶	DRWTK	EX	EX_OL	FBFL	FD ⁷

FDSRTBTM	FLUT ⁸	FTK ⁹	ID	IH	INVRM ¹⁰	IW ¹¹	LIGHT	MIP	OBRB	PFINBTMB	RD	RECTK	RECTK_6 ¹²	RECTKERT6	RH	ROSFLUT	RT

RW	SBCADDY	SBCADDYSM	SCPDRW	SRT	STW	TD	TKP	TVR ¹³	UDBX ⁴	URT	VTK	WS ¹⁴	WTCD ¹⁵	WTKCUP ¹⁶	WTR

¹ Not available on 9", 12" or 24" (2 doors) wide.

² Not available on 9" wide.

³ Only available on 24" (2 doors)-39" wide.

⁴ Only available on 24" (1 door and 2 doors)-39" wide.

⁵ Not available on 9", 12" or 24" (2 doors) wide.

⁶ Not available on 9"-15", 27"-39", or 45" wide.

⁷ Only available on 30" and 36" wide.

⁸ 6" fluting not available on 9", 12", 15", or 24" (2 doors) wide. Fluting both 6" also not available on 18-24" (1 door) wide.

⁹ FTKAV and style B-L not available on 9" or 12" wide.

¹⁰ Not available on 21" wide.

¹¹ Not available on 24" (1 door) or 48" wide.

¹² 9" or 12" wide can only be recessed in front and/or back. 15" and 18" wide can only be recessed in the front, back, and/or one side only.

¹³ Not available on 18", 21", 24" (2 doors), or 27" wide. TVRAV and style B-L also not available on 12" or 42" wide.

¹⁴ Not available on 9" or 24" (2 doors) wide.

¹⁵ Only available on 15", 18", 21", 24", 30", 36", 42", and 48" wide.

¹⁶ Only available on 18" and 36" wide.

IH/RH availability charts starting on page G•40.
IW/RW availability charts starting on page G•46.

Base Peninsula Cabinets

FULL HEIGHT BASE PENINSULA, 34 1/2" HIGH, 24" DEEP

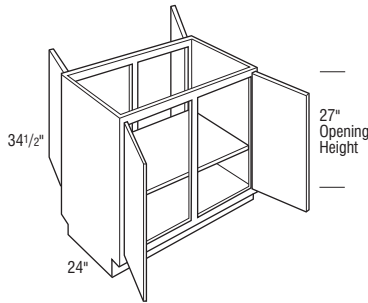
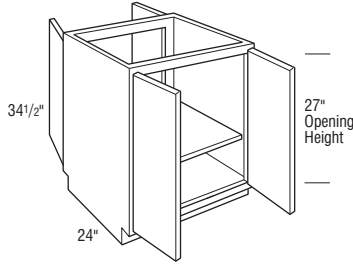
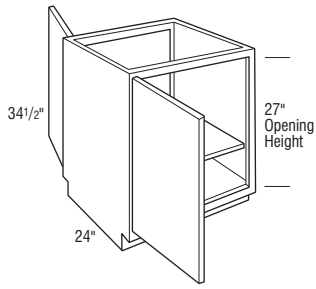

	Cubic Feet	1	2	3	4	5	6	7
B9FHP L or R	5.8	1644	1723	1784	1877	1988	2175	2362
B12FHP L or R	7.5	1682	1770	1827	1923	2040	2227	2414
B15FHP L or R	9.1	1707	1791	1854	1951	2067	2256	2445
B18FHP L or R	10.8	1811	1901	1970	2073	2196	2399	2602
B21FHP L or R	12.4	1834	1926	1990	2097	2223	2430	2637
B24FHP L or R	14.1	1945	2043	2111	2223	2359	2575	2791
B24FHP	14.1	2334	2455	2537	2672	2833	3094	3355
B27FHP	15.7	2464	2583	2676	2816	2986	3260	3534
B30FHP	17.4	2794	2935	3035	3195	3387	3700	4013
B33FHP	19.0	2824	2966	3066	3229	3422	3737	4052
B36FHP	20.7	2922	3068	3178	3345	3547	3874	4201
B39FHP	22.4	2988	3136	3243	3417	3622	3956	4290
B42FHP	24.0	3189	3352	3465	3649	3870	4226	4582
B45FHP	25.7	3296	3460	3582	3770	3994	4366	4738
B48FHP	27.3	3398	3571	3695	3889	4125	4501	4877

Notes below apply to all products in section above:

- One adjustable Full Depth Shelf.
- Specify location of modification for front or peninsula side.
- Increased Depths available in 1/4" increments from 24 1/4" to 30".
- Reduced Depths available in 1/4" increments from 6" to 23 3/4".
- Exceptions may apply when using IW with Clipped Corners or Wide Stiles. Please reference these sections in Section G for more details.

Door & Drawer Options

AF	AOMBWB	CC	CG	GAMD ¹	IFHG	MD ¹	PRMD ²	PTOWB	SHMD ¹	SPLITDR ³	SPLITDRWS	TCP
				✓	✓	✓	✓		✓	✓		

End Panel Options

AUTH	CSFPE	EXBK	FFD	FL/FR	FPE	INTGE	IPE
✓	✓	✓	✓	✓	✓	✓	✓

Custom Modification Options

ADD_SHLF	ADDTK	CBO	CCO	CFNT0	CFP	CFRMO	CHGDRW	CLIP ⁴	CMAT	CND	CSDGBK	DRT	DRWSEC	DRWTK	EX	EX_OL	FBFL	FD
✓	✓	✓	✓	✓	✓	✓	✓	✓	✓	✓	✓	✓	✓	✓	✓	✓	✓	✓

FDSRTBTM	FLUT ⁵	FTK ⁶	ID	IH	INVERM	IW ⁷	LIGHT	MIP	OBRB	PFINBTMB	RD	RECTK	RECTK_6 ⁸	RECTKFRT ⁶	RH	ROSFLUT ⁹	RT
✓	✓	✓	✓	✓	✓	✓	✓	✓	✓	✓	✓	✓	✓	✓	✓	✓	✓

RW	SBCADDY	SBCADDYSM	SCPDRW	SRT	STW	TD	TKP	TVR ¹⁰	UDBX	URT	VTK	WS ¹¹	WTCO	WTKCUP	WTR
								✓	✓	✓	✓	✓	✓	✓	✓

¹ Not available on 9" wide.

² Not available on 9", 12" or 24" (2 doors) wide.

³ Only available on 30"-39" wide.

⁴ Not available on 9", 12" or 24" (2 doors) wide.

⁵ Not available on 24" (2 doors) or 27" wide. Fluting both 3" not available on 9" wide. 6" fluting not available on 9"-21" wide.

⁶ FTKAV and style B-L not available on 9" or 12" wide.

⁷ Not available on 48" wide.

⁸ 9" and 12" wide can only be recessed in front and/or back. 15" and 18" wide can only be recessed in the front, back, and/or one side only.

⁹ Not available on 24" (2 doors) or 27" wide. Fluting both not available on 9" or 30"-48" wide.

¹⁰ Not available on 9" or 42"-48" wide. TVRAV and style B-L also not available on 12" wide.

¹¹ Not available on 9" wide and wide stile 3" also not available on 12" wide.

Base Corner Peninsula Cabinets

	Cubic Feet	1	2	3	4	5	6	7
BASE CORNER PENINSULA, 34 1/2" HIGH BCP27	15.7	2010	2109	2187	2309	2430	2656	2882

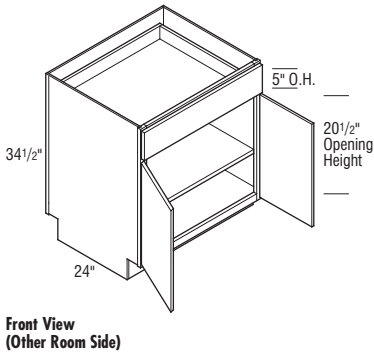

- Specify location of modification for front or peninsula side.
- One adjustable Full Depth Shelf.
- Reduced Depths available in 1/4" increments from 12" to 23 3/4".

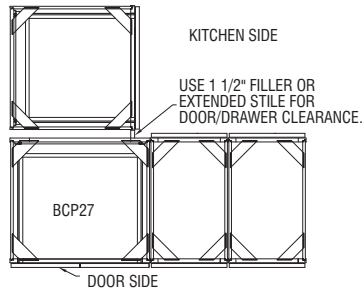

OTHER ROOM SIDE
Top View

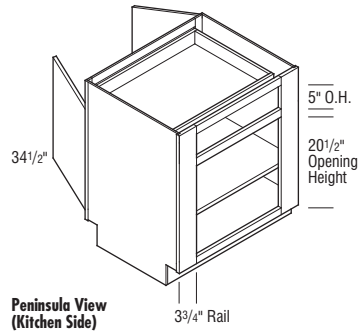

Door & Drawer Options

AF	AOMBWB	CC	CG	GAMD	IFHG	MD	PRMD	PTOWB	SHMD	SPLITDR	SPLITDRWS	TCP
					✓							

End Panel Options

AUTH	CSFPE	EXBK	FFD	FL/FR	FPE	INTGE	IPE
✓	✓			✓	✓	✓	✓

Custom Modification Options

ADD_SHLF	ADDTK	CBO	CCO	CFNTO	CFP	CFRMO	CHGDRW	CLIP	CMAT	CND	CSDGBK	DRT	DRWSEC	DRWTK	EX	EX_OL	FBFL	FD
								✓							✓	✓		

FDSRTBTM	FLUT ¹	FTK	ID	IH	INVFRM	IW	LIGHT	MIP	OBRB	PFINBTMB	RD	RECTK	RECTK_6	RECTKFR6	RH	ROSFLUT ²	RT
	✓		✓				✓				✓		✓	✓	✓	✓	

RW	SBCADDY	SBCADDYSM	SCPDW	SRT	STW	TD	TKP	TVR	UDBX	URT	VTK	WS	WTCO	WTKCUP	WTR
												✓			

¹ Only available with FLUT3B.P.

² Only available with ROSFLUT3B.P.

IH/RH availability charts starting on page G-40.
IW/RW availability charts starting on page G-46.

Base with Tray Divider Cabinets

FULL HEIGHT BASE with TRAY DIVIDER, 34 1/2" HIGH, 24" DEEP

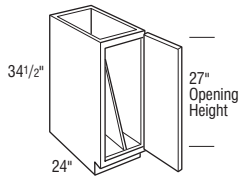

	Cubic Feet	1	2	3	4	5	6	7
TD6FH L or R	4.1	958	1010	1026	1079	1144	1249	1354
TD9FH L or R	5.8	1140	1197	1241	1305	1385	1517	1649
TD12FH L or R	7.5	1187	1241	1287	1351	1431	1564	1697
TD15FH L or R	9.1	1234	1297	1346	1417	1503	1631	1759
TD18FH L or R	10.8	1281	1341	1391	1463	1546	1690	1834

Door & Drawer Options

AF	AOMBWB	CC	CG ¹	GAMD ²	IFHG ³	MD ²	PRMD ⁴	PTOWB	SHMD ²	SPLITDR	SPLITDRWS	TCP
			✓	✓	✓	✓	✓		✓			

End Panel Options

AUTH	CSFPE	EXBK	FFD ¹	FL/FR	FPE	INTGE	IPE ¹
✓	✓	✓	✓	✓	✓	✓	✓

Custom Modification Options

ADD_SHLF	ADDTK	CBO	CCO ³	CFNT0	CFP ¹	CFRMO	CHGDRW	CLIP ⁵	CMAT	CND	CSDGBK	DRT	DRWSEC	DRWTK	EX	EX_OL	FBFL	FD
			✓	✓	✓	✓				✓	✓				✓	✓		
FDSRTBTM	FLUT ⁶	FTK ⁷	ID	IH	INVRM ⁸	IW ⁸	LIGHT	MIP	OBRB	PFINBTMB	RD	RECTK	RECTK_6	RECTKFRT6	RH	ROSFLUT ⁹	RT	
	✓	✓	✓	✓		✓		✓	✓		✓				✓	✓		
RW	SBCADDY	SBCADDYSM	SCPDRW	SRT	STW	TD	TKP	TVR ¹⁰	UDBX	URT	VTK	WS	WTCD	WTKCUP	WTR			
								✓				✓			✓			

- ¹ Not available on 6" wide.
- ² Not available on 6" or 9" wide.
- ³ Only available on 6" wide.
- ⁴ Only available on 15" wide.
- ⁵ Not available on 6" or 12" wide.
- ⁶ Fluting both 3" not available on 9"-12" wide. 6" fluting not available.
- ⁷ FTKAV and style B-L not available on 6"-12" wide.
- ⁸ Not available on 18" wide.
- ⁹ Fluting both not available on 9"-12" wide.
- ¹⁰ Not available on 6" wide. TVRAV and style B-L also not available on 9" or 12" wide.

BASE with TRAY DIVIDER, 34 1/2" HIGH, 24" DEEP

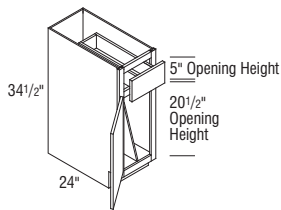

	TD9 L or R	TD12 L or R
	5.8 1195 1247 1299 1367 1438 1567 1696	7.5 1226 1287 1337 1406 1485 1628 1771

- Reduced Depths available in 1/4" increments from 12" to 23 3/4".

Door & Drawer Options

AF	AOMBWB	CC	CG	GAMD ¹	IFHG	MD ¹	PRMD	PTOWB	SHMD ¹	SPLITDR	SPLITDRWS	TCP
				✓	✓	✓			✓			

End Panel Options

AUTH	CSFPE	EXBK	FFD	FL/FR	FPE	INTGE	IPE
✓	✓	✓	✓	✓	✓	✓	✓

Custom Modification Options

ADD_SHLF	ADDTK	CBO	CCO	CFNT0	CFP	CFRMO	CHGDRW	CLIP	CMAT	CND	CSDGBK	DRT	DRWSEC	DRWTK	EX	EX_OL	FBFL	FD
			✓	✓	✓	✓				✓	✓				✓	✓		
FDSRTBTM	FLUT ²	FTK ³	ID	IH	INVRM ¹	IW	LIGHT	MIP	OBRB	PFINBTMB	RD	RECTK	RECTK_6	RECTKFRT6	RH	ROSFLUT	RT	
	✓	✓	✓	✓		✓		✓	✓		✓				✓	✓		
RW	SBCADDY	SBCADDYSM	SCPDRW	SRT	STW	TD	TKP	TVR ⁴	UDBX	URT	VTK	WS	WTCD	WTKCUP	WTR			
								✓				✓			✓			

- ¹ Not available on 9" wide.
- ² Not available with 6" fluting.
- ³ Not available with FTKAV and style B-L.
- ⁴ TVRAV and style B-L not available on 9" wide.

Base with Roll-out Tray Divider & Base Transition Cabinets

BASE with ROLL-OUT TRAY DIVIDER, 34 1/2" HIGH, 24" DEEP L G I X

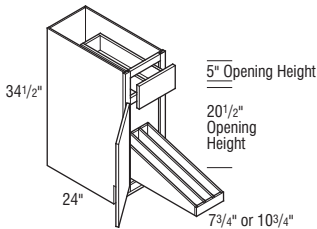

	Cubic Feet	1	2	3	4	5	6	7
B12TDRO L or R	7.5	1855	1935	1994	2091	2207	2391	2575
B15TDRO L or R	9.1	1952	2035	2099	2207	2313	2510	2707

• Pull-out has three compartments.

• Pull-out has four compartments.

Notes below apply to all products in section above:

- Dividers are removable.
- Not available on Inset and Beaded Inset styles.

Door & Drawer Options

AF	AOMBWB	CC	CG	GAMD	IFHG	MD	PRMD ¹	PTOWB	SHMD	SPLITDR	SPLITDRWS	TCP

End Panel Options

AUTH	CSFPE	EXBK	FFD	FL/FR	FPE	INTGE	IPE

Custom Modification Options

ADD	SHLF	ADDTK	CBO	CCO	CFNTO	CFP	CFRMO	CHGDRW	CLIP	CMAT	CND	CSDGBK	DRT	DRWSEC	DRWTK	EX	EX_OL	FBFL	FD	

FDSRTBTM	FLUT ²	FTK ³	ID	IH	INVFRM	IW	LIGHT	MIP	OBRB	PFINBTMB	RD	RECTK	RECTK_6	RECTKFRT6	RH	ROSLUT	RT

RW	SBCADDY	SBCADDYSM	SCPDWR	SRT	STW	TD	TKP	TVR ⁴	UDBX	URT	VTK	WS	WTCD ¹	WTKCUP	WTR

¹ Not available on 12" wide.

² Not available with 6" fluting.

³ FTKAV and style B-L not available on 12" wide.

⁴ TVRAV and style B-L not available on 12" wide.

BASE TRANSITION CABINET, 34 1/2" HIGH

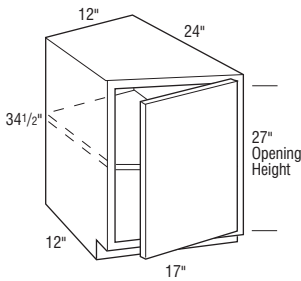

Left Angle Shown

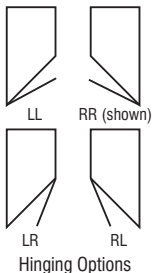

Hinging Options

BTC12LL	7.5	1514	1582	1644	1732	1806	1970	2134
BTC12RR	7.5	1514	1582	1644	1732	1806	1970	2134
BTC12LR	7.5	1514	1582	1644	1732	1806	1970	2134
BTC12RL	7.5	1514	1582	1644	1732	1806	1970	2134

- One adjustable Full Depth Shelf.
- Flushed Ends, FFD on End, Inset Panel Ends, and Integral Ends available on angled side only.
- Increased Depths available in 1/4" increments from 24 1/4" to 30".
- Reduced Depths available in 1/4" increments from 18" to 23 3/4".
- When Inset or Beaded Inset styles are specified, the door must be hinged on the same side as the angle side.

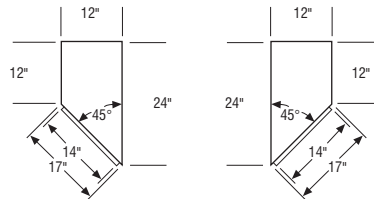

Door & Drawer Options

AF	AOMBWB	CC	CG	GAMD	IFHG	MD	PRMD	PTOWB	SHMD	SPLITDR	SPLITDRWS	TCP

End Panel Options

AUTH ¹	CSFPE ²	EXBK	FFD	FL/FR	FPE	INTGE ³	IPE

Custom Modification Options

ADD	SHLF	ADDTK	CBO	CCO	CFNTO	CFP	CFRMO	CHGDRW	CLIP	CMAT	CND	CSDGBK	DRT	DRWSEC	DRWTK	EX	EX_OL	FBFL	FD	

FDSRTBTM	FLUT	FTK	ID	IH	INVFRM	IW	LIGHT	MIP	OBRB	PFINBTMB	RD	RECTK	RECTK_6	RECTKFRT6	RH	ROSLUT	RT

RW	SBCADDY	SBCADDYSM	SCPDWR	SRT	STW	TD	TKP	TVR	UDBX	URT	VTK	WS	WTCD	WTKCUP	WTR

¹ Not available on authentic flush ends both.

² Not available with car siding flush panel ends left.

³ Not available on depths less than 24".

IH/RH availability charts starting on page G-40.
IW/RW availability charts starting on page G-46.

BASE END CABINET, 34 1/2" HIGH, 24" DEEP

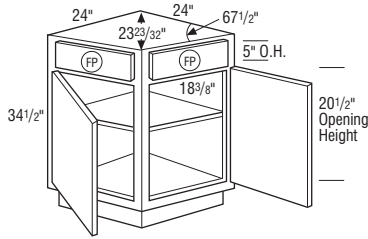

FP False Panel

BEC24FP

Cubic Feet	1	2	3	4	5	6	7
14.1	2061	2165	2239	2367	2480	2708	2936

- One adjustable Full Depth Shelf.
- Includes top support panel for stability, 3/8" thick.
- Wood Top with dimensions to match this unit is available for field installation. See page Q•7.
- Finished Ends available on one end only.
- When Inset or Beaded Inset styles are specified, the doors must be hinged to the center face frame stiles.

Door & Drawer Options

AF	AOMBWB	CC	CG	GAMD	IFHG	MD	PRMD	PTOWB	SHMD	SPLITDR	SPLITDRWS	TCP
		✓	✓	✓	✓	✓			✓		✓	

End Panel Options

AUTH ¹	CSFPE	EXBK	FFD	FL/FR	FPE	INTGE	IPE
✓			✓				

Custom Modification Options

ADD_SHLF	ADDTK	CBO	CCO	CFNTD	CFP	CFRMO	CHGDRW	CLIP	CMAT	CND	CSDGBK	DRT	DRWSEC	DRWTK	EX	EX_OL	FBFL	FD
			✓	✓		✓				✓								

FDSRTBTM	FLUT	FTK	ID	IH	INVFRM	IW	LIGHT	MIP	OBRB	PFINBTMB	RD	RECTK	RECTK_6	RECTKFR6	RH	ROSFLUT	RT
		✓	✓					✓	✓			✓				✓	

RW	SBCADDY	SBCADDYSM	SCPDRW	SRT	STW	TD	TKP	TVR	UDBX	URT	VTK	WS	WTCB	WTKCUP	WTR
								✓				✓			✓

¹ Not available with authentic flush ends both.

BASE END CABINET, 34 1/2" HIGH, 24" DEEP

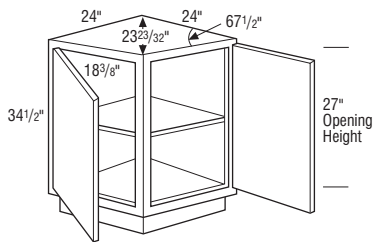

BEC24

Cubic Feet	1	2	3	4	5	6	7
14.1	2061	2165	2239	2367	2480	2708	2936

- One adjustable Full Depth Shelf.
- Wood Top with dimensions to match this unit is available for field installation. See page Q•7.
- Finished Ends available on one end only.
- When Inset or Beaded Inset styles are specified, the doors must be hinged to the center face frame stiles.

Door & Drawer Options

AF	AOMBWB	CC	CG	GAMD	IFHG	MD	PRMD	PTOWB	SHMD	SPLITDR	SPLITDRWS	TCP
		✓	✓	✓	✓	✓			✓			

End Panel Options

AUTH ¹	CSFPE	EXBK	FFD	FL/FR	FPE	INTGE	IPE
✓			✓				

Custom Modification Options

ADD_SHLF	ADDTK	CBO	CCO	CFNTD	CFP	CFRMO	CHGDRW	CLIP	CMAT	CND	CSDGBK	DRT	DRWSEC	DRWTK	EX	EX_OL	FBFL	FD
			✓	✓		✓				✓								

FDSRTBTM	FLUT	FTK	ID	IH	INVFRM	IW	LIGHT	MIP	OBRB	PFINBTMB	RD	RECTK	RECTK_6	RECTKFR6	RH	ROSFLUT	RT
		✓	✓					✓	✓			✓				✓	

RW	SBCADDY	SBCADDYSM	SCPDRW	SRT	STW	TD	TKP	TVR	UDBX	URT	VTK	WS	WTCB	WTKCUP	WTR
								✓				✓			✓

¹ Not available with authentic flush ends both.

Base Angled Cabinets

BASE ANGLED CABINET and FULL HEIGHT BASE ANGLED CABINET, 34 1/2" HIGH – 45° ANGLE

	Cubic Feet	1	2	3	4	5	6	7
BAC24	14.1	1990	2090	2156	2276	2398	2618	2838
BAC24FH	14.1	1990	2090	2156	2276	2398	2618	2838

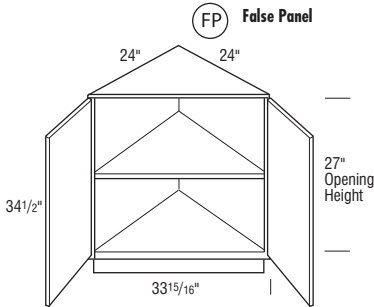
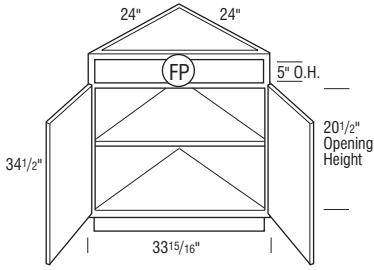

Notes below apply to all products in section above:

- One adjustable Full Depth Shelf.
- Wood Top with dimensions to match this unit is available for field installation. See page Q•7.
- Finished Ends available on one end only.
- Only available in Inset and Beaded Inset when used in conjunction with a finial hinge.

Door & Drawer Options

AF	AOMBWB	CC	CG	GAMD	IFHG	MD	PRMD	PTOWB	SHMD	SPLITDR	SPLITDRWS ¹	TCP
			✓	✓	✓	✓	✓		✓	✓	✓	

End Panel Options

AUTH ²	CSFPE	EXBK	FFD	FL/FR	FPE	INTGE	IPE
✓							

Custom Modification Options

ADD_SHLF	ADDTK	CBO	CCO	CFNTD	CFP	CFRMO	CHGDRW	CLIP	CMAT	CND	CSDGBK	DRT	DRWSEC	DRWTK	EX	EX_OL	FBFL	FD
		✓	✓	✓	✓	✓				✓								
FDSRTBTM	FLUT	FTK	ID	IH	INVFRM	IW	LIGHT	MIP	OBRB	PFINBTMB	RD	RECTK ¹	RECTK_6	RECTKFT6	RH	ROSFLOT	RT	
		✓	✓	✓				✓	✓			✓			✓			
RW	SBCADDY	SBCADDYSM	SCPRDW	SRT	STW	TD	TKP	TVR	UDBX	URT	VTK	WS	WTCB	WTKCUP	WTR			
							✓				✓				✓			

¹ Not available on BAC24FH version.

² Not available with authentic flush ends both.

IH/RH availability charts starting on page G•40.
IW/RW availability charts starting on page G•46.

135° Corner Base Cabinets

135° CORNER OUTSIDE BASE, 34 1/2" HIGH, 24" DEEP

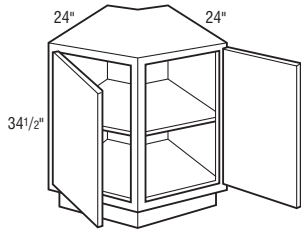

Cubic Feet	1	2	3	4	5	6	7
BFH6COA	21.2	2715	2761	2913	3091	3218	3790
BFH9COA	26.4	2909	2957	3120	3313	3448	4060
BFH12COA	32.1	3103	3154	3328	3533	3677	4331

- Doors are hinged on outside of frame.
- Adjustable shelf cannot be removed from cabinet.
- No leg changes allowed.
- Reduced depths available in 3" increments from 12" to 21".

Model	A Dimension	B Dimension
BFH6COA	6"	15 15/16"
BFH9COA	9"	18 15/16"
BFH12COA	12"	21 15/16"

A indicates back width of cabinet and wall space
B indicates face frame width

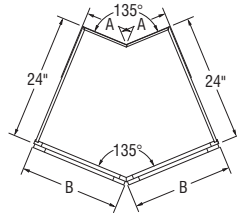

Top View

Door & Drawer Options

AF	AOMBWB	CC	CG	GAMD	IFHG	MD	PRMD	PTOWB	SHMD	SPLITDR	SPLITDRWS	TCP
			✓		✓	✓	✓		✓			

End Panel Options

AUTH	CSFPE	EXBK	FFD	FL/FR	FPE	INTGE	IPE
✓	✓			✓	✓		

Custom Modification Options

ADD_SHLF	ADDTK	CBO	CCO	CFNTO	CFP	CFRMO	CHGDRW	CLIP	CMAT	CND	CSDGBK	DRT	DRWTK	DRWSEC	EX	EX_OL ¹	FBFL	FD
			✓	✓						✓	✓					✓	✓	

FDSRTBTM	FLUT	FTK	ID	IH	INVFRM	IW	LIGHT	MIP	OBRB	PFINBTMB	RD	RECTK	RECTK_6	RECTKFR6	RH	ROSFLUT	RT
				✓				✓		✓	✓						

RW	SBCADDY	SBCADDYSM	SCPDRW	SRT	STW	TD	TKP	TVR	UDBX	URT	VTK	WS	WTC	WTKCUP	WTR
													✓		✓

¹ Not available with extended stile both.

135° Corner Base Cabinets

**135° CORNER INSIDE BASE,
34 1/2" HIGH, 24" DEEP**

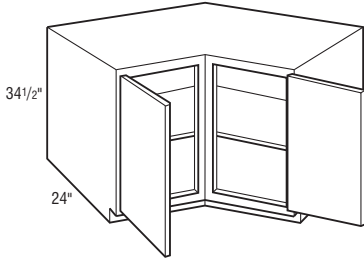

	Cubic Feet	1	2	3	4	5	6	7
BFH21CIA	29.4	2715	2761	2913	3091	3218	3504	3790
BFH24CIA	35.3	2909	2957	3120	3313	3448	3754	4060
BFH27CIA	41.7	3103	3154	3328	3533	3677	4004	4331

- Doors are hinged on outside of frame.
- Adjustable shelf cannot be removed from cabinet.
- No leg changes allowed.
- Reduced depths available in 3" increments from 12" to 21".

Model	A Dimension	B Dimension
BFH21CIA	21"	11 3/32"
BFH24CIA	24"	14 3/32"
BFH27CIA	27"	17 3/32"

A indicates back width of cabinet and wall space
B indicates face frame width

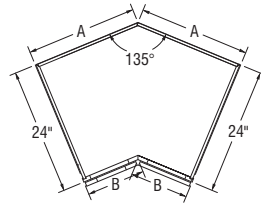

Top View

Door & Drawer Options

AF	AOMBWB	CC	CG	GAMD	IFHG	MD	PRMD	PTOWB	SHMD	SPLITDR	SPLITDRWS	TCP
			✓		✓	✓	✓			✓		

End Panel Options

AUTH	CSFPE	EXBK	FFD	FL/FR	FPE	INTGE	IPE
✓	✓			✓	✓		

Custom Modification Options

ADD	SHLF	ADDTK	CBO	CCO	CFNTO	CFP	CFRMO	CHGDRW	CLIP	CMAT	CND	CSDGBK	DRT	DRWSEC	DRWTK	EX	EX_OL	FBFL	FD
			✓	✓							✓	✓							

FDSRTBTM	FLUT ¹	FTK	ID	IH	INVFRM	IW	LIGHT	MIP	OBRB	PFINBTMB	RD	RECTK	RECTK_6	RECTKFR6	RH	ROSFLUT	RT
	✓			✓				✓			✓	✓					✓

RW	SBCADDY	SBCADDYSM	SCPRW	SRT	STW	TD	TKP	TVR	UDBX	URT	VTK	WS	WTCO	WTKCUP	WTR
												✓			✓

¹ Not available with 6" fluting.

IH/RH availability charts starting on page G•40.
IW/RW availability charts starting on page G•46.

BASE with MIXER SHELF, 34 1/2" HIGH, 24" DEEP

L G I X

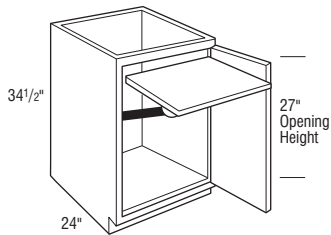

	Cubic Feet	1	2	3	4	5	6	7
B18FHMIXSC L or R	10.8	2487	2606	2708	2847	3009	3285	3561
B21FHMIXSC L or R	12.4	2572	2692	2792	2941	3093	3408	3723
B24FHMIXSC L or R	14.1	2649	2777	2880	3039	3205	3486	3767

- Weight capacity of mixer shelf is 26 pounds.
- Appliance height clearance for swing-out mixer shelf is 20".
- Mixer Shelf features Smart Stop.

Door & Drawer Options

AF	AOMBWB	CC	CG	GAMD	IFHG	MD	PRMD	PTOWB	SHMD	SPLITDR	SPLITDRWS	TCP
		✓	✓	✓	✓	✓	✓		✓			

End Panel Options

AUTH	CSFPE	EXBK	FFD	FL/FR	FPE	INTGE	IPE
✓	✓	✓		✓	✓		

Custom Modification Options

ADD_SHLF	ADDTK	CBO	CCO	CFNTD	CFP	CFRMO	CHGDRW	CLIP	CMAT	CND	CSDGBK	DRT	DRWSEC	DRWTK	EX	EX_OL	FBFL	FD
										✓				✓	✓	✓		

FDSRTBTM	FLUT ¹	FTK	ID	IH	INVFRM	IW	LIGHT	MIP	OBRB	PFINBTMB	RD	RECTK	RECTK_6 ²	RECTKFR6	RH	ROSLUT	RT
	✓	✓					✓					✓	✓	✓		✓	

RW	SBCADDY	SBCADDYSM	SCPDRW	SRT	STW	TD	TKP	TVR	UDBX	URT	VTK	WS	WTCO	WTKCUP	WTR
							✓				✓				

¹ Not available with 6" fluting.

² 18" wide can only be recessed in the front, back, and/or one side only.

BASE with PLASTIC STORAGE BINS, 34 1/2" HIGH, 24" DEEP

L G I X

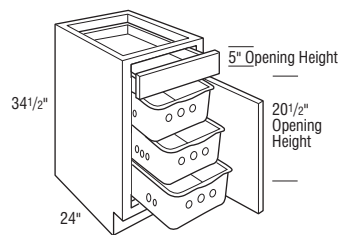

B15PSB L or R	9.1	1742	1823	1890	1990	2091	2287	2483
B18PSB L or R	10.8	1789	1872	1936	2046	2165	2371	2577

- Three plastic pull-out storage bins, 10" W x 5" H x 13 1/2" D.
- Unit is 11 1/2" W x 21" H x 17 3/4" D.
- Reduced Depth of 21" available.
- Only available in Inset and Beaded Inset when used in conjunction with a finial hinge.
- B15PSB L or R not available in Inset.

Door & Drawer Options

AF	AOMBWB	CC	CG	GAMD	IFHG	MD	PRMD	PTOWB	SHMD	SPLITDR	SPLITDRWS	TCP
		✓	✓	✓	✓	✓	✓		✓			

End Panel Options

AUTH	CSFPE	EXBK	FFD	FL/FR	FPE	INTGE	IPE
✓	✓	✓		✓	✓	✓	

Custom Modification Options

ADD_SHLF	ADDTK	CBO	CCO	CFNTD	CFP	CFRMO	CHGDRW ¹	CLIP	CMAT	CND	CSDGBK	DRT	DRWSEC ¹	DRWTK	EX	EX_OL	FBFL	FD
							✓						✓	✓	✓	✓		

FDSRTBTM	FLUT ²	FTK	ID	IH	INVFRM	IW	LIGHT	MIP	OBRB	PFINBTMB	RD	RECTK	RECTK_6 ³	RECTKFR6	RH	ROSLUT	RT
	✓	✓					✓					✓	✓	✓		✓	

RW	SBCADDY	SBCADDYSM	SCPDRW	SRT	STW	TD	TKP	TVR ⁴	UDBX	URT	VTK	WS	WTCO	WTKCUP ⁵	WTR
							✓	✓			✓		✓	✓	✓

¹ Only available on 18" wide.

² Not available with 6" fluting.

³ Can only be recessed in the front, back, and/or one side only.

⁴ Not available on 18" wide.

⁵ Not available on 15" wide.

Base Open Basket Cabinets & Base Box Column Pull-outs

BASE OPEN BASKET with ARCHED VALANCE, 34 1/2" HIGH, 24" DEEP

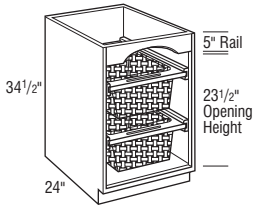

	Cubic Feet	1	2	3	4	5	6	7
BOB15AV	9.1	3601	3601	3601	3601	3601	3601	3601
• Basket size 11 5/16" W x 7 7/8" H x 21 1/4" D.								
BOB18AV	10.8	3668	3668	3668	3668	3668	3668	3668
• Basket size 14 5/16" W x 7 7/8" H x 21 1/4" D.								

Notes below apply to all products in section above:

- Matching Interior standard.
- Two wicker baskets.
- Handles and Rails are natural finish.
- Finish of wicker baskets will be the same regardless of cabinet finish/door style.
- Arched Top Valance Rail standard.
- Not available on Beaded Inset styles.

Door & Drawer Options

AF	AOMBWB	CC	CG	GAMD	IFHG	MD	PRMD	PTOWB	SHMD	SPLITDR	SPLITDRWS	TCP
----	--------	----	----	------	------	----	------	-------	------	---------	-----------	-----

End Panel Options

AUTH	CSFPE	EXBK	FFD	FL/FR	FPE	INTGE	IPE
✓	✓	✓	✓	✓	✓		

Custom Modification Options

ADD	SHLF	ADDTK	CBO	CCO	CFNTO	CFP	CFRMO	CHGDRW	CLIP	CMAT	CND	CSDGBK	DRT	DRWSEC	DRWTK	EX	EX_OL	FBFL	FD	
	✓			✓	✓		✓					✓					✓	✓		
FDSRTBTM	FLUT ¹	FTK	ID	IH	INVFRM	IW	LIGHT	MIP	OBRB	PFINBTMB	RD	RECTK	RECTK_6	RECTKFT6	RH	ROSFLUT	RT			
	✓	✓							✓			✓				✓				
RW	SBCADDY	SBCADDYSM	SCPDRW	SRT	STW	TD	TKP	TVR ²	UDBX	URT	VTK	WS	WTCO	WTKCUP	WTR					
								✓	✓		✓				✓					

¹ Not available with 6" fluting.

² Not available on TVRAV and style B-L.

BASE BOX COLUMN PULL-OUT, PLAIN, 30" HIGH, 3" or 6" WIDE

L O G I X

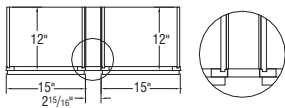
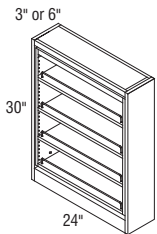

Top View Installation

		2.2	1855	1855	1855	1855	1855	1855	1855
BBCP03									
BBCP06		3.6	2073	2073	2073	2073	2073	2073	2073

- Fluting modification available, when no overlay filler is specified.
- Hardware required on base units.
- Matching interior not available.

Door & Drawer Options

AF	AOMBWB	CC	CG	GAMD	IFHG	MD	PRMD	PTOWB	SHMD	SPLITDR	SPLITDRWS	TCP
----	--------	----	----	------	------	----	------	-------	------	---------	-----------	-----

End Panel Options

AUTH	CSFPE	EXBK	FFD	FL/FR	FPE	INTGE	IPE

Custom Modification Options

ADD	SHLF	ADDTK	CBO	CCO	CFNTO	CFP	CFRMO	CHGDRW	CLIP	CMAT	CND	CSDGBK	DRT	DRWSEC	DRWTK	EX	EX_OL	FBFL	FD	
FDSRTBTM	FLUT	FTK	ID	IH	INVFRM	IW	LIGHT	MIP	OBRB	PFINBTMB	RD	RECTK	RECTK_6	RECTKFT6	RH	ROSFLUT	RT			
	✓															✓				
RW	SBCADDY	SBCADDYSM	SCPDRW	SRT	STW	TD	TKP	TVR	UDBX	URT	VTK	WS	WTCO	WTKCUP	WTR					

IH/RH availability charts starting on page G•40.
IW/RW availability charts starting on page G•46.

Base Box Column & Base Pantry Pull-outs

BASE BOX COLUMN PULL-OUT, OVERLAY, 3" or 6" WIDE, 30" HIGH

L G I X

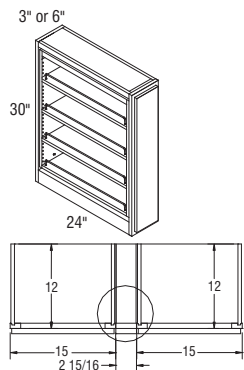

Top View Installation

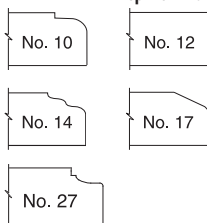

BBCP03OL

BBCP06OL

Cubic Feet	1	2	3	4	5	6	7
BBCP03OL	2.2	1855	1855	1855	1855	1855	1855
BBCP06OL	3.6	2073	2073	2073	2073	2073	2073

- Features adjustable shelves.
- Standard face application includes profiled full overlay filler.
- Edge profile will match door profile selected (#10, #12, #14, #17, #27).
- Pull or knob hardware required on base units.
- Top and bottom of unit are always Natural Maple.
- Not available on end of run.
- 2 1/8" clearance between chrome rails on shelves of 3" wide unit.
- 5 1/8" clearance between chrome rails on shelves of 6" wide unit.
- Fluting modification available when No Overlay modification is specified. See page G-38 for details.

Door & Drawer Options

AF	AOMBWB	CC	CG	GAMD	IFHG	MD	PRMD	PTOWB	SHMD	SPLITDR	SPLITDRWS	TCP
----	--------	----	----	------	------	----	------	-------	------	---------	-----------	-----

End Panel Options

AUTH	CSFPE	EXBK ¹	FFD	FL/FR	FPE	INTGE	IPE
------	-------	-------------------	-----	-------	-----	-------	-----

Custom Modification Options

ADD_SHLF	ADDTK	CBO	CCO	CFNTO	CFP	CFRMO	CHGDRW	CLIP	CMAT	CND	CSDGBK	DRT	DRWSEC	DRWTK	EX	EX_OL	FBFL	FD
FDSRTBTM	FLUT	FTK	ID	IH	INVFRM	IW	LIGHT	MIP	OBRB	PFINBTMB	RD	RECTK	RECTK_6	RECTKFR6	RH	ROSLUT	RT	
RW	SBCADDY	SBCADDYSM	SCPDRW	SRT	STW	TD	TKP	TVR	UDBX	URT	VTK	WS	WTC	WTKCUP	WTR			

¹ Not available with end extended back left.

BASE PANTRY PULL-OUT, 34 1/2" HIGH, 24" DEEP

L G I X

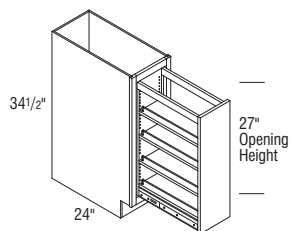

BPP9

BPP12

BPP15

BPP18

BPP9	5.8	2543	2668	2763	2911	3085	3377	3669
BPP12	7.5	2855	2995	3106	3277	3446	3764	4082
BPP15	9.1	3289	3446	3580	3768	3980	4351	4722
BPP18	10.8	3741	3928	4066	4282	4541	4966	5391

- Features adjustable shelves.

Door & Drawer Options

AF	AOMBWB	CC	CG	GAMD	IFHG	MD	PRMD	PTOWB	SHMD ¹	SPLITDR	SPLITDRWS	TCP
----	--------	----	----	------	------	----	------	-------	-------------------	---------	-----------	-----

End Panel Options

AUTH	CSFPE	EXBK	FFD	FL/FR	FPE	INTGE	IPE
------	-------	------	-----	-------	-----	-------	-----

Custom Modification Options

ADD_SHLF	ADDTK	CBO	CCO	CFNTO	CFP	CFRMO	CHGDRW	CLIP	CMAT	CND	CSDGBK	DRT	DRWSEC	DRWTK	EX	EX_OL	FBFL	FD
FDSRTBTM	FLUT ³	FTK ⁴	ID	IH	INVFRM	IW	LIGHT	MIP	OBRB	PFINBTMB	RD	RECTK	RECTK_6	RECTKFR6	RH	ROSLUT	RW	
RW	SBCADDY	SBCADDYSM	SCPDRW	SRT	STW	TD	TKP	TVR	UDBX	URT	VTK	WS	WTC	WTKCUP	WTR			

¹ Not available on 9" wide.

² Only available on 15" wide.

³ Not available with 6" fluting.

⁴ FTKAV and style B-L not available on 9" or 12" wide.

Base Spice & Base Utensil Pantry Pull-outs

	Cubic Feet	1	2	3	4	5	6	7	
BASE SPICE PULL-OUT, 34 1/2" HIGH, 24" DEEP	BSP12PG	7.5	3139	3294	3413	3603	3793	4141	4489
	BSP15PG	9.1	3611	3786	3929	4149	4371	4778	5185

L G I X

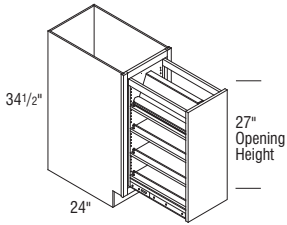

Spice Insert Top Shelf

- Features adjustable shelves.

Door & Drawer Options

AF	AOMBWB	CC	CG	GAMD	IFHG	MD	PRMD	PTOWB	SHMD	SPLITDR	SPLITDRWS	TCP
									✓			

End Panel Options

AUTH	CSFPE	EXBK	FFD	FL/FR	FPE	INTGE	IPE
✓	✓	✓		✓	✓	✓	✓

Custom Modification Options

ADD_SHLF	ADDTK	CBO	CCO	CFNT0	CFP	CFRMO	CHGDRW	CLIP	CMAT	CND	CSDGBK	DRT	DRWSEC	DRWTK	EX	EX_OL	FBFL	FD
															✓	✓		

FDSRTBTM	FLUT ²	FTK ³	ID	IH	INVRM	IW	LIGHT	MIP	OBRB	PFINBTMB	RD	RECTK	RECTK_6	RECTKFR6	RH	ROSFLUT	RT
	✓	✓						✓	✓							✓	

RW	SBCADDY	SBCADDYSM	SCPDWR	SRT	STW	TD	TKP	TVR	UDBX	URT	VTK	WS	WTCO	WTKCUP	WTR
													✓		✓

¹ Not available with 6" fluting.

² FTKAV and style B-L not available on 12" wide.

BASE UTENSIL PANTRY PULL-OUT, 34 1/2" HIGH, 24" DEEP

L G I X

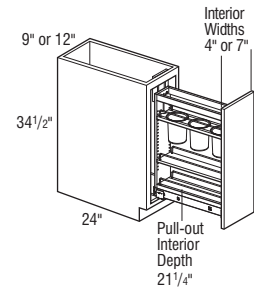

BUPP9	5.8	2994	3144	3256	3428	3635	3976	4317
BUPP12	7.5	3448	3620	3747	3945	4185	4577	4969

- Features Smart Stop pull-out with two adjustable shelves (including canister shelf) and one fixed shelf with chrome rails.
- Top shelf features three stainless steel (removable) canisters for utensils.
- BUPP9 canisters are 5.85" tall and have an inside diameter of 4.3". BUPP12 canisters are 6.7" tall and have an inside diameter of 5".

Door & Drawer Options

AF	AOMBWB	CC	CG	GAMD	IFHG	MD	PRMD	PTOWB	SHMD ¹	SPLITDR	SPLITDRWS	TCP
									✓			

End Panel Options

AUTH	CSFPE	EXBK	FFD	FL/FR	FPE	INTGE	IPE
✓	✓	✓		✓	✓	✓	✓

Custom Modification Options

ADD_SHLF	ADDTK	CBO	CCO	CFNT0	CFP	CFRMO	CHGDRW	CLIP	CMAT	CND	CSDGBK	DRT	DRWSEC	DRWTK	EX	EX_OL	FBFL	FD
															✓	✓		

FDSRTBTM	FLUT ²	FTK ³	ID	IH	INVRM	IW	LIGHT	MIP	OBRB	PFINBTMB	RD	RECTK	RECTK_6	RECTKFR6	RH	ROSFLUT	RT
	✓	✓						✓	✓							✓	

RW	SBCADDY	SBCADDYSM	SCPDWR	SRT	STW	TD	TKP	TVR	UDBX	URT	VTK	WS	WTCO	WTKCUP	WTR
													✓		✓

¹ Only available on 12" wide.

² Not available with 6" fluting.

³ Not available with FTKAV and style B-L.

IH/RH availability charts starting on page G•40.
IW/RW availability charts starting on page G•46.

Base Utensil Pantry & Base Tray Divider Pantry Pull-outs

BASE UTENSIL PANTRY PULL-OUT with KNIFE BLOCK, 34 1/2" HIGH, 24" DEEP

L G I X

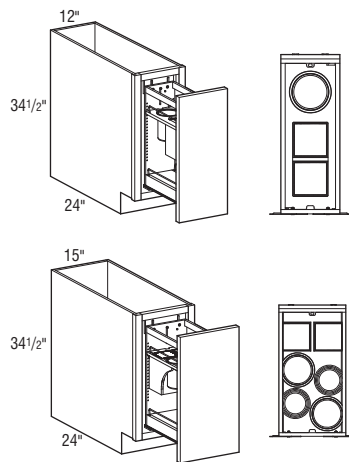

	Cubic Feet	1	2	3	4	5	6	7
BUPPKB12	7.5	3901	4095	4239	4466	4735	5179	5623
BUPPKB15	9.1	4450	4672	4837	5094	5402	5909	6416

- Features Smart Stop pull-out with adjustable knife and canister shelf and one fixed shelf with chrome rails.
- BUPPKB12 includes one stainless steel canister, 6.7" tall and has an inside diameter of 5".
- BUPPKB15 includes two stainless steel canisters 5.85" tall with an inside diameter of 4.3", and two stainless steel canisters 6.7" tall with an inside diameter of 5".
- Knife block features movable flex rods that adjust to hold a multitude of knives.

Door & Drawer Options

AF	AOMBWB	CC	CG	GAMD	IFHG	MD	PRMD	PTOWB	SHMD	SPLITDR	SPLITDRWS	TCP
									✓			

End Panel Options

AUTH	CSFPE	EXBK	FFD	FL/FR	FPE	INTGE	IPE
✓	✓	✓	✓	✓	✓	✓	✓

Custom Modification Options

ADD_SHLF	ADDTK	CBO	CCO	CFNT0	CFP	CFRMO	CHGDRW	CLIP	CMAT	CND	CSDGBK	DRT	DRWSEC	DRWTK	EX	EX_OL	FBFL	FD
										✓						✓	✓	

FDSRTBTM	FLUT ¹	FTK ²	ID	IH	INVFRM	IW	LIGHT	MIP	OBRB	PFINBTMB	RD	RECTK	RECTK_6	RECTKFT6	RH	ROSFLUT	RT
	✓	✓						✓	✓							✓	

RW	SBCADDY	SBCADDYSM	SCPDRW	SRT	STW	TD	TKP	TVR	UDBX	URT	VTK	WS	WTC	WTKCUP	WTR
													✓		✓

¹ Not available with 6" fluting.
² Not available with FTKAV and style B-L.

BASE TRAY DIVIDER PANTRY PULL-OUT, 34 1/2" HIGH, 24" DEEP

L G I X

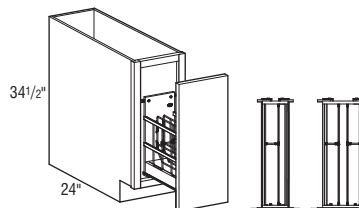

	5.8	2736	2874	2975	3132	3321	3633	3945
BTDP9	5.8	2736	2874	2975	3132	3321	3633	3945
BTDP12	7.5	3059	3212	3325	3501	3714	4062	4410

- Features Smart Stop slides.
- BTDP9 includes one removable center divider and one snap on T-bar.
- BTDP12 includes two removable center dividers and two snap on T-bars.
- Tray dividers are chrome plated steel.

Door & Drawer Options

AF	AOMBWB	CC	CG	GAMD	IFHG	MD	PRMD	PTOWB	SHMD ¹	SPLITDR	SPLITDRWS	TCP
									✓			

End Panel Options

AUTH	CSFPE	EXBK	FFD	FL/FR	FPE	INTGE	IPE
✓	✓	✓	✓	✓	✓	✓	✓

Custom Modification Options

ADD_SHLF	ADDTK	CBO	CCO	CFNT0	CFP	CFRMO	CHGDRW	CLIP	CMAT	CND	CSDGBK	DRT	DRWSEC	DRWTK	EX	EX_OL	FBFL	FD
																✓	✓	

FDSRTBTM	FLUT ²	FTK ³	ID	IH	INVFRM	IW	LIGHT	MIP	OBRB	PFINBTMB	RD	RECTK	RECTK_6	RECTKFT6	RH	ROSFLUT	RT
	✓	✓						✓	✓							✓	

RW	SBCADDY	SBCADDYSM	SCPDRW	SRT	STW	TD	TKP	TVR	UDBX	URT	VTK	WS	WTC	WTKCUP	WTR
													✓		✓

¹ Not available on 9" wide.
² Not available with 6" fluting.
³ Not available with FTKAV and style B-L.

Base Organization Cabinets

	Cubic Feet	1	2	3	4	5	6	7
--	------------	---	---	---	---	---	---	---

BASE CONTAINER ORGANIZATION PANTRY, 34 1/2" HIGH, 24" DEEP

L O G I X

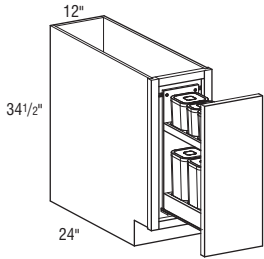

BCOPP12

- Features Smart Stop slides.
- Includes 7 OXO Good Grips® POP containers, BPA Free: (3) 1.7 quart, (1) 2.6 quart, (3) 4.3 quart.
- Fixed shelf.

Door & Drawer Options

AF	AOMBWB	CC	CG	GAMD	IFHG	MD	PRMD	PTOWB	SHMD	SPLITDR	SPLITDRWS	TCP
										✓		

End Panel Options

AUTH	CSFPE	EXBK	FFD	FL/FR	FPE	INTGE	IPE
✓	✓	✓	✓	✓	✓	✓	✓

Custom Modification Options

ADD	SHLF	ADDTK	CBO	CCO	CFNTO	CFP	CFRMO	CHGDRW	CLIP	CMAT	CND	CSDGBK	DRT	DRWSEC	DRWTK	EX	EX_OL	FBFL	FD	
																	✓	✓		

FDSRTBTM	FLUT ¹	FTK	ID	IH	INVFRM	IW	LIGHT	MIP	OBRB	PFINBTMB	RD	RECTK	RECTK_6	RECTKFRT6	RH	ROSLUT	RT
	✓	✓						✓	✓							✓	

RW	SBCADDY	SBCADDYSM	SCPDRW	SRT	STW	TD	TKP	TVR	UDBX	URT	VTK	WS	WTCO	WTKCUP	WTR
													✓		✓

¹ Not available with 6" fluting.

BASE with SPICE DRAWER, 34 1/2" HIGH, 24" DEEP

L O G I X

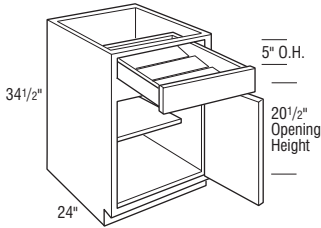

B18SD L or R

10.8	1340	1389	1429	1495	1561	1687	1813
------	------	------	------	------	------	------	------

B24SD L or R

14.1	1442	1501	1543	1615	1683	1816	1949
------	------	------	------	------	------	------	------

- One adjustable 15" deep shelf.
- Spice Drawer Insert not trimmable.

Door & Drawer Options

AF	AOMBWB	CC	CG	GAMD	IFHG	MD	PRMD	PTOWB	SHMD	SPLITDR	SPLITDRWS	TCP
				✓	✓	✓	✓	✓	✓			

End Panel Options

AUTH	CSFPE	EXBK	FFD	FL/FR	FPE	INTGE	IPE
✓	✓	✓	✓	✓	✓	✓	✓

Custom Modification Options

ADD	SHLF	ADDTK	CBO	CCO	CFNTO	CFP	CFRMO	CHGDRW	CLIP	CMAT	CND	CSDGBK	DRT	DRWSEC	DRWTK ¹	EX	EX_OL	FBFL	FD
															✓	✓	✓	✓	✓

FDSRTBTM	FLUT ²	FTK	ID	IH	INVFRM ³	IW	LIGHT	MIP	OBRB	PFINBTMB	RD	RECTK	RECTK_6	RECTKFRT6	RH	ROSLUT	RT
	✓	✓	✓	✓	✓			✓	✓							✓	✓

RW	SBCADDY	SBCADDYSM	SCPDRW	SRT	STW	TD	TKP	TVR ³	UDBX	URT	VTK	WS	WTCO	WTKCUP	WTR ³
								✓	✓		✓				✓

¹ Not available on 18" wide.

² Not available with 6" fluting.

³ Not available on 24" wide.

IH/RH availability charts starting on page G-40.
IW/RW availability charts starting on page G-46.

Base Wastebasket Cabinets

BASE WASTEBASKET, 34 1/2" HIGH, 24" DEEP

L O G I X

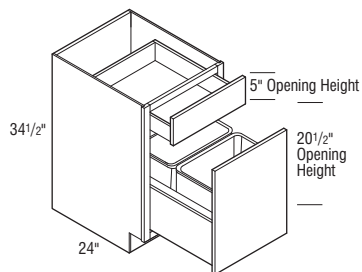
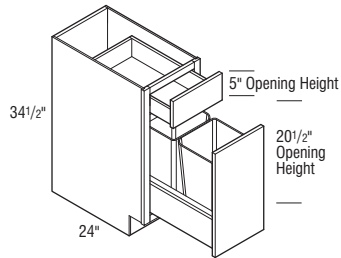
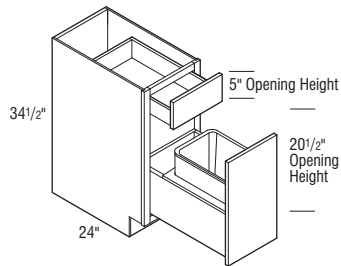

	Cubic Feet	1	2	3	4	5	6	7
BWB15	9.1	2284	2389	2476	2618	2764	3026	3288
BWB152	9.1	2565	2689	2785	2936	3110	3395	3680
BWB18	10.8	2391	2514	2606	2747	2911	3170	3429
BWB21	12.4	2444	2560	2650	2786	2935	3210	3485
BWB24	14.1	2511	2628	2720	2860	3015	3293	3571

• One 35 quart wastebasket included.

• Includes two 27 quart wastebaskets.

• Two 35 quart wastebaskets and one lid included. Wastebasket lid is operational on front wastebasket only.

Notes below apply to all products in section above:

- Features Smart Stop slides.
- Wastebasket is metallic gray.
- Panel inserted under drawer.
- It is recommended that the front wastebasket be removed for easier removal of the back wastebasket.
- Wastebasket pull-out box will be 6 3/8" high.

Door & Drawer Options

AF	AOMBWB	CC	CG	GAMD	IFHG	MD	PRMD	PTOWB ¹	SHMD	SPLITDR	SPLITDRWS	TCP
	✓							✓				

End Panel Options

AUTH	CSFPE	EXBK	FFD	FL/FR	FPE	INTGE	IPE
✓	✓	✓	✓	✓	✓	✓	✓

Custom Modification Options

ADD	SHLF	ADDTK	CBO	CCO	CFNTO	CFP	CFRMO	CHGDRW	CLIP	CMAT	CND	CSDGBK	DRT	DRWSEC ²	DRWTK	EX	EX_OL	FBFL	FD
			✓	✓							✓	✓		✓	✓	✓	✓		

FDSRTBTM ³	FLUT ⁴	FTK	ID	IH	INVERM	IW	LIGHT	MIP	OBRB	PFINBTMB	RD	RECTK	RECTK_6 ⁵	RECTKRT6	RH	ROSFLUT	RT
✓	✓	✓	✓	✓	✓	✓	✓	✓	✓	✓	✓	✓	✓	✓	✓	✓	✓

RW	SBCADDY	SBCADDYSM	SCPDRW	SRT	STW	TD	TKP	TVR	UDBX	URT	VTK	WS	WTCO	WTKCUP	WTR
			✓				✓				✓			✓	✓

¹ Not available on 24" wide.
² Not available on 15" wide.
³ Only available on 18" wide.
⁴ Not available with 6" fluting.
⁵ 15" and 18" wide can only be recessed in the front, back, and/or one side only.

Base Wastebasket Cabinets

BASE WASTEBASKET FULL HEIGHT, 34 1/2" HIGH, 24" DEEP

L O G I X

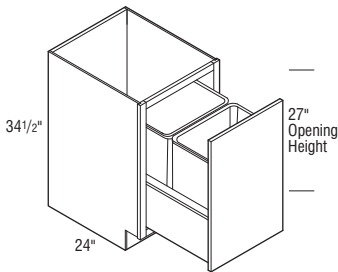
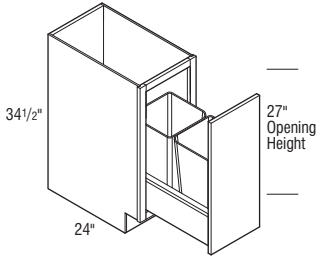
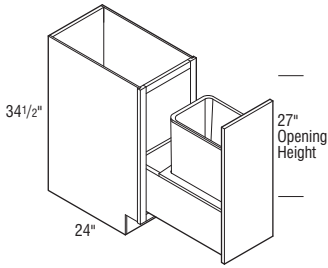

	Cubic Feet	1	2	3	4	5	6	7
BWB15FH	9.1	2417	2640	2738	2902	3088	3478	3868
BWB18FH	10.8	2667	2888	2989	3150	3339	3727	4115

- One 50 quart wastebasket included.
- Wastebasket pull-out box will be 10" high.

BWB15FH2	9.1	2379	2495	2584	2724	2886	3150	3414
BWB18FH2	11.1	2385	2501	2590	2731	2893	3157	3421

- BWB15FH2 includes two 27 quart wastebaskets. Wastebasket pull-out box will be 6 3/8" high.
- BWB18FH2 includes two 35 quart wastebaskets and one lid included. Wastebasket lid is operational on front wastebasket only. Wastebasket pull-out box will be 10" high.

BWB21FH	12.4	2925	3173	3281	3460	3668	4003	4338
BWB24FH	14.1	3019	3276	3385	3571	3786	4132	4478

- Two 50 quart wastebaskets and one lid included. Wastebasket lid is operational on front wastebasket only.
- Wastebasket pull-out box will be 10" high.

Notes below apply to all products in section above:

- Features Smart Stop slides.
- Wastebasket is metallic gray.
- It is recommended that the front wastebasket be removed for easier removal of the back wastebasket.

Door & Drawer Options

AF	AOMBWB	CC	CG	GAMD	IFHG	MD	PRMD	PTOWB ¹	SHMD	SPLITDR	SPLITDRWS	TCP
	✓							✓				

End Panel Options

AUTH	CSFPE	EXBK	FFD	FL/FR	FPE	INTGE	IPE
✓	✓	✓		✓	✓	✓	✓

Custom Modification Options

ADD	SHLF	ADDTK	CBO	CCO	CFNTO	CFP	CFRMO	CHGDRW	CLIP	CMAT	CND	CSDGBK	DRT	DRWSEC	DRWTK	EX	EX_OL	FBFL	FD
			✓	✓							✓	✓			✓	✓	✓		

FDSRTBTM	FLUT ²	FTK	ID	IH	INFRM	IW	LIGHT	MIP	OBRB	PFINBTMB	RD	RECTK	RECTK_6 ³	RECTKFRT6	RH	ROSFLUT	RT
	✓	✓	✓					✓	✓			✓	✓	✓		✓	

RW	SBCADDY	SBCADDYSM	SCPDWR ⁴	SRT	STW	TD	TKP	TVR	UDBX	URT	VTK	WS	WTCD	WTKCUP	WTR
			✓					✓			✓				✓

¹ Not available on 24" wide.

² Not available with 6" fluting.

³ 15" and 18" wide can only be recessed in the front, back, and/or one side only.

⁴ Only available on 24" wide.

IH/RH availability charts starting on page G•40.
IW/RW availability charts starting on page G•46.

Base Wastebasket Cabinets

BASE WASTEBASKET FULL HEIGHT with ROLL TRAY, 34 1/2" HIGH, 24" DEEP

L G I X

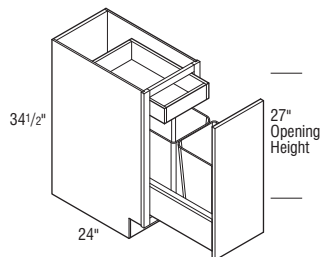

Cubic Feet	1	2	3	4	5	6	7
BWB15FHRT2	9.1	2816	2952	3058	3224	3415	4041
BWB18FHRT2	11.1	2822	2958	3064	3231	3422	4048

- BWB15FHRT2 includes two 27 quart wastebaskets.
- BWB18FHRT2 includes two 35 quart wastebaskets.
- Features Smart Stop slides.
- Wastebasket is metallic gray.
- It is recommended that the front wastebasket be removed for easier removal of the back wastebasket.
- On the BWB18FHRT2, one lid will be included. Wastebasket lid is operational on front wastebasket only.
- 15" wide will have a 6 3/8" high wastebasket pull-out box.
- 18" wide will have a 10" high wastebasket pull-out box.

Door & Drawer Options

AF	AOMBWB	CC	CG	GAMD	IFHG	MD	PRMD	PTOWB ¹	SHMD	SPLITDR	SPLITDRWS	TCP
✓								✓				

End Panel Options

AUTH	CSFPE	EXBK	FFD	FL/FR	FPE	INTGE	IPE
✓	✓	✓		✓	✓	✓	✓

Custom Modification Options

ADD_SHLF	ADDTK	CBO	CCO	CFNTO	CFP	CFRMO	CHGDRW	CLIP	CMAT	CND	CSDGBK	DRT	DRWSEC	DRWTK	EX	EX_OL	FBFL	FD
		✓	✓							✓	✓			✓	✓	✓		

FDSRTBTM	FLUT ¹	FTK	ID	IH	INVFRM	IW	LIGHT	MIP	OBRB	PFINBTMB	RD	RECTK	RECTK ²	RECTKRT6	RH	ROSFLUT ⁵	RT
	✓	✓	✓									✓	✓	✓	✓	✓	✓

RW	SBCADDY	SBCADDYSM	SCPDRW	SRT	STW	TD	TKP	TVR	UDBX	URT	VTK	WS	WTCDD ³	WTKCUP	WTR
											✓		✓	✓	✓

¹ Not available with 6" fluting.

² Can only be recessed in the front, back, and/or one side only.

³ Only available on 15" wide.

BASE WASTEBASKET with BREAD BOARD, 34 1/2" HIGH, 24" DEEP

L G I X

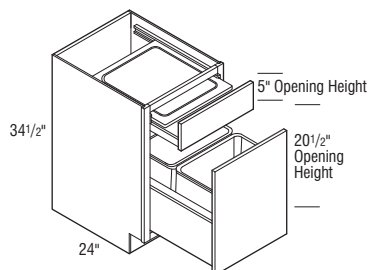
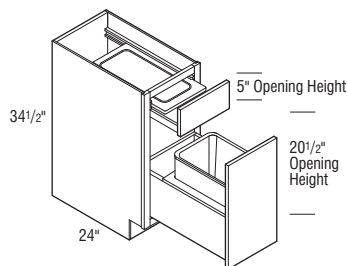

Cubic Feet	1	2	3	4	5	6	7
BWB15BB	9.1	3114	3240	3340	3512	3681	4313

- One 35 quart wastebasket included.

BWB18BB	10.8	3340	3490	3596	3764	3965	4272	4579
----------------	------	------	------	------	------	------	------	------

BWB21BB	12.4	3447	3592	3694	3868	4052	4367	4682
----------------	------	------	------	------	------	------	------	------

BWB24BB	14.1	3543	3693	3798	3976	4167	4490	4813
----------------	------	------	------	------	------	------	------	------

- Two 35 quart wastebaskets and one lid included. Wastebasket lid is operational on front wastebasket only.

Notes below apply to all products in section above:

- Features Smart Stop slides.
- Wastebasket is metallic gray.
- Panel inserted under drawer.
- It is recommended that the front wastebasket be removed for easier removal of the back wastebasket.
- Wastebasket pull-out box will be 6 3/8" high.

Door & Drawer Options

AF	AOMBWB	CC	CG	GAMD	IFHG	MD	PRMD	PTOWB ¹	SHMD	SPLITDR	SPLITDRWS	TCP
✓								✓				

End Panel Options

AUTH	CSFPE	EXBK	FFD	FL/FR	FPE	INTGE	IPE
✓	✓	✓		✓	✓	✓	✓

Custom Modification Options

ADD_SHLF	ADDTK	CBO	CCO	CFNTO	CFP	CFRMO	CHGDRW	CLIP ²	CMAT	CND	CSDGBK	DRT	DRWSEC	DRWTK	EX	EX_OL	FBFL	FD
								✓			✓			✓	✓	✓		

FDSRTBTM	FLUT ³	FTK	ID	IH	INVFRM	IW	LIGHT	MIP	OBRB	PFINBTMB	RD	RECTK	RECTK ⁴	RECTKRT6	RH	ROSFLUT ⁵	RT
	✓	✓	✓									✓	✓	✓	✓	✓	✓

RW	SBCADDY	SBCADDYSM	SCPDRW	SRT	STW	TD	TKP	TVR	UDBX	URT	VTK	WS	WTCDD ³	WTKCUP	WTR
											✓		✓	✓	✓

¹ Not available on 24" wide.

² Not available on 15" wide.

³ Fluting both 3" not available on 15"-18" wide. Not available with 6" fluting.

⁴ 15" and 18" wide can only be recessed in the front, back, and/or one side only.

⁵ Fluting both not available on 15"-18" wide.

Base Wastebasket Cabinets

BASE WASTEBASKET with WOOD TIERED CUTLERY DIVIDER, 34 1/2" HIGH, 24" DEEP

L G I X

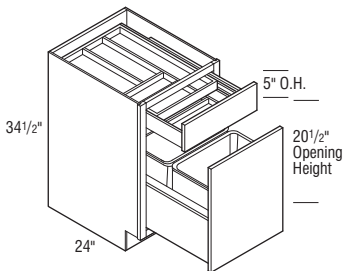
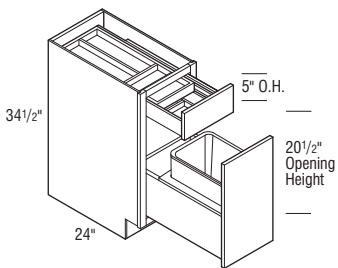

	Cubic Feet	1	2	3	4	5	6	7
BWB15WTC	9.1	2559	2664	2751	2893	3039	3301	3563
BWB18WTC	10.8	2666	2789	2881	3022	3186	3445	3704
BWB21WTC	12.4	2719	2835	2925	3061	3210	3485	3760
BWB24WTC	14.1	3011	3128	3220	3360	3515	3793	4071

• One 35 quart wastebasket included.

BWB18WTC

BWB21WTC

BWB24WTC

• Two 35 quart wastebaskets and one lid included. Wastebasket lid is operational on front wastebasket only.

Notes below apply to all products in section above:

- Features Smart Stop slides.
- Includes Wood Tiered Cutlery Divider Drawer.
- Exterior WTC drawer box height is 3 3/4", interior height of top and bottom tier is 1 3/8".
- Wood Tiered Cutlery Divider Drawer is also available as an accessory for field installation. See page S•5.
- Different sizes of the cutlery dividers may have different configurations. Please reference the accessory section on page S•5 for more details.
- Wastebasket is metallic gray.
- Panel inserted under drawer.
- It is recommended that the front wastebasket be removed for easier removal of the back wastebasket.
- Wastebasket pull-out box will be 6 3/8" high.

Door & Drawer Options

AF	AOMBWB	CC	CG	GAMD	IFHG	MD	PRMD	PTOWB ¹	SHMD	SPLITDR	SPLITDRWS	TCP
✓								✓				

End Panel Options

AUTH	CSFPE	EXBK	FFD	FL/FR	FPE	INTGE	IPE
✓	✓			✓	✓	✓	✓

Custom Modification Options

ADD	SHLF	ADDTK	CBO	CCO	CFNTO	CFP	CFRMO	CHGDRW	CLIP	CMAT	CND	CSDGBK	DRT	DRWSEC	DRWTK	EX	EX_OL	FBFL	FD
			✓	✓	✓						✓	✓			✓	✓			

FDSRTBTM	FLUT ²	FTK	ID	IH	INVFRM	IW	LIGHT	MIP	OBRB	PFINBTMB	RD	RECTK	RECTK_6 ³	RECTKFR6	RH	ROSFLUT ²	RT
	✓	✓	✓					✓	✓			✓	✓	✓		✓	

RW	SBCADDY	SBCADDYSM	SCPDW	SRT	STW	TD	TKP	TVR	UBX	URT	VTK	WS	WTC	WTKCUP	WTR
								✓			✓				✓

¹ Not available on 24" wide.

² Fluting both 3" not available on 15"-18" wide. Not available with 6" fluting.

³ 15" and 18" wide can only be recessed in the front, back, and/or one side only.

BASE WASTEBASKET with WOOD TIERED K-CUP* DRAWER, 34 1/2" HIGH, 24" DEEP

L G I X

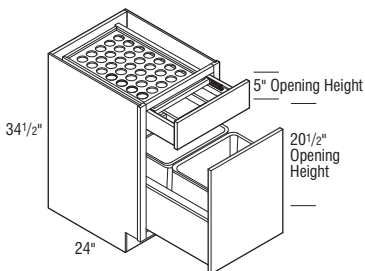

	Cubic Feet	1	2	3	4	5	6	7
BWB18KCP	10.8	3411	3585	3714	3917	4147	4521	4895

- Features Smart Stop slides.
- Holds 40 K-Cups.
- The Wood Tiered K-Cup Drawer is compatible with K-Cup pods only.
- Exterior Wood Tiered K-Cup drawer box height is 3 3/4", interior height of top tier is 1 5/8", and interior height of bottom tier is 1 3/8".
- Two 35 quart wastebaskets and one lid included. Wastebasket lid is operational on front wastebasket only.
- Wastebasket is metallic gray.
- Panel inserted under drawer.
- It is recommended that the front wastebasket be removed for easier removal of the back wastebasket.
- Wastebasket pull-out box will be 6 3/8" high.

*K-Cup is a registered trademark of Keurig Green Mountain, Inc.

Door & Drawer Options

AF	AOMBWB	CC	CG	GAMD	IFHG	MD	PRMD	PTOWB	SHMD	SPLITDR	SPLITDRWS	TCP
✓								✓				

End Panel Options

AUTH	CSFPE	EXBK	FFD	FL/FR	FPE	INTGE	IPE
✓	✓			✓	✓	✓	✓

Custom Modification Options

ADD	SHLF	ADDTK	CBO	CCO	CFNTO	CFP	CFRMO	CHGDRW	CLIP	CMAT	CND	CSDGBK	DRT	DRWSEC	DRWTK	EX	EX_OL	FBFL	FD
			✓	✓	✓										✓	✓			

FDSRTBTM	FLUT ¹	FTK	ID	IH	INVFRM	IW	LIGHT	MIP	OBRB	PFINBTMB	RD	RECTK	RECTK_6 ²	RECTKFR6	RH	ROSFLUT	RT
	✓	✓	✓					✓	✓			✓	✓	✓		✓	

RW	SBCADDY	SBCADDYSM	SCPDW	SRT	STW	TD	TKP	TVR	UBX	URT	VTK	WS	WTC	WTKCUP	WTR
								✓			✓				✓

¹ Not available with 6" fluting.

² Can only be recessed in the front, back, and/or one side only.

IH/RH availability charts starting on page G•40.
IW/RW availability charts starting on page G•46.

BASE WASTEBASKET with CHARGING DRAWER, 34 1/2" HIGH, 24" DEEP

L G I X

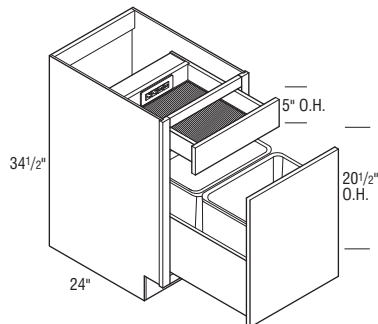

Cubic Feet	1	2	3	4	5	6	7	
BWB18CHGDRW	10.8	3641	3764	3856	3997	4161	4420	4679

- Two 35 quart wastebaskets and one lid included. Wastebasket lid is operational on front wastebasket only.
- Features Smart Stop slides.
- Wastebasket is metallic gray.
- Panel inserted under drawer.
- It is recommended that the front wastebasket be removed for easier removal of the back wastebasket.
- Wastebasket pull-out box will be 6 3/8" high.
- Charging drawer has full extension, concealed Smart Stop slides.
- 110 lb. rated.
- 120V outlet must be installed in rear of cabinet within 10" of bottom of drawer, in rear of cabinet.
- CUL US listed power strip with two 120V plugs and two 2.1 amp USB ports.
- Max Current: AC 15 amps @ 120VAC; USB 2.1 amp and 5 VDC each.
- Tamper resistant outlets.
- Power cord with NEMA 5-15 plug.
- Integrated cord guide mounts to cabinet side to ensure safe operation.
- Black, shock absorbing mat included.
- Special sizes not available.
- Only available in 24" deep.
- Not available on Inset or Beaded Inset Styles.

Door & Drawer Options

AF	AOMBWB	CC	CG	GAMD	IFHG	MD	PRMD	PTOWB	SHMD	SPLITDR	SPLITDRWS	TCP
	✓								✓			

End Panel Options

AUTH	CSFPE	EXBK	FFD	FL/FR	FPE	INTGE	IPE
✓	✓	✓	✓	✓	✓	✓	✓

Custom Modification Options

ADD_SHLF	ADDTK	CBO	CCO	CFNTO	CFP	CFRMO	CHGDRW	CLIP	CMAT	CND	CSDGBK	DRT	DRWSEC	DRWTK	EX	EX_OL	FBFL	FD
		✓	✓	✓		✓				✓	✓			✓	✓	✓		

FDSRTBTM	FLUT	FTK	ID	IH	INVFRM	IW	LIGHT	MIP	OBRB	PFINBTMB	RD	RECTK	RECTK_6 ¹	RECTKFRT6	RH	ROSFLUT	RT
				✓				✓	✓			✓	✓	✓			

RW	SBCADDY	SBCADDYSM	SCPDRW	SRT	STW	TD	TKP	TVR	UDBX	URT	VTK	WS	WTCO	WTKCUP	WTR
								✓			✓				✓

¹ Can only be recessed in the front, back, and/or one side only.

Base Wine & Spice Cabinets

BASE WINE CUBBY, 34 1/2" HIGH, 24" DEEP

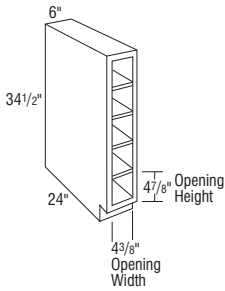

	Cubic Feet	1	2	3	4	5	6	7
BWC6	3.9	1207	1207	1207	1207	1207	1207	1207
BWC640.5	4.5	1261	1261	1261	1261	1261	1261	1261
BWC646.5	5.2	1314	1314	1314	1314	1314	1314	1314

• Five openings.

• Six openings.

• Seven openings.

Notes below apply to all products in section above:

- Matching Interior standard.
- Finished or Flush Panel Ends must be specified if required.
- Available as separate unit only.
- Not available with Beaded Inset styles.
- Reduced Depths available in 1/4" increments from 12" to 23 3/4".

Door & Drawer Options

AF	AOMBWB	CC	CG	GAMD	IFHG	MD	PRMD	PTOWB	SHMD	SPLITDR	SPLITDRWS	TCP
----	--------	----	----	------	------	----	------	-------	------	---------	-----------	-----

End Panel Options

AUTH	CSFPE	EXBK	FFD	FL/FR	FPE	INTGE	IPE
✓	✓				✓		

Custom Modification Options

ADD_SHLF	ADDTK	CBO	CCO	CFNTO	CFP	CFRMO	CHGDRW	CLIP	CMAT	CND	CSDGBK	DRT	DRWSEC	DRWTK	EX	EX_OL	FBFL	FD
FDSRTBTM	FLUT	FTK	ID	IH	INVFRM	IW	LIGHT	MIP	OBRB	PFINBTMB	RD	RECTK	RECTK_6	RECTKFRT6	RH	ROSLUT	RT	
		✓				✓				✓								
RW	SBCADDY	SBCADDYSM	SCPDWR	SRT	STW	TD	TKP	TVR	UBX	URT	VTK	WS	WTCO	WTKCUP	WTR			
												✓						

BASE SPICE DRAWER, 34 1/2" HIGH, 24" DEEP

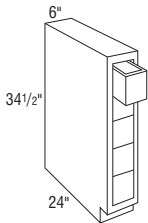

	Cubic Feet	1	2	3	4	5	6	7
BSD6	3.9	1760	1760	1760	1760	1760	1760	1760
BSD640.5	4.5	1854	1854	1854	1854	1854	1854	1854
BSD646.5	5.2	1904	1904	1904	1904	1904	1904	1904

• Five drawers.

• Six drawers.

• Seven drawers.

Notes below apply to all products in section above:

- Matching Interior standard.
- Finished or Flush Panel Ends must be specified if required.
- Not available on Inset or Beaded Inset Styles.
- Reduced Depths available in 3" increments from 12" to 24".

Door & Drawer Options

AF	AOMBWB	CC	CG	GAMD	IFHG	MD	PRMD	PTOWB	SHMD	SPLITDR	SPLITDRWS	TCP
----	--------	----	----	------	------	----	------	-------	------	---------	-----------	-----

End Panel Options

AUTH	CSFPE	EXBK ¹	FFD	FL/FR	FPE	INTGE	IPE
	✓	✓			✓		

Custom Modification Options

ADD_SHLF	ADDTK	CBO	CCO	CFNTO	CFP	CFRMO	CHGDRW	CLIP	CMAT	CND	CSDGBK	DRT	DRWSEC	DRWTK	EX	EX_OL	FBFL	FD
FDSRTBTM	FLUT	FTK	ID	IH	INVFRM	IW	LIGHT	MIP	OBRB	PFINBTMB	RD	RECTK	RECTK_6	RECTKFRT6	RH	ROSLUT	RT	
		✓				✓				✓								
RW	SBCADDY	SBCADDYSM	SCPDWR	SRT	STW	TD	TKP	TVR	UBX	URT	VTK	WS	WTCO	WTKCUP	WTR			
												✓						

¹ Not available on end extended back left.

IH/RH availability charts starting on page G•40.
IW/RW availability charts starting on page G•46.

Base Bottle Storage Cabinet & Base Shelves

BASE with BOTTLE STORAGE, 34 1/2" HIGH, 24" DEEP L G I X

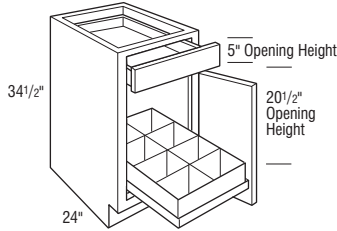

Cubic Feet	1	2	3	4	5	6	7	
BBS18 L or R	10.8	1668	1747	1805	1890	2009	2188	2367

- Pull-out includes eight storage compartments, each compartment is 5 1/4" x 4 3/8".
- Not available on Inset and Beaded Inset styles.

Door & Drawer Options

AF	AOMBWB	CC	CG	GAMD	IFHG	MD	PRMD	PTOWB	SHMD	SPLITDR	SPLITDRWS	TCP
	✓		✓		✓	✓			✓			

End Panel Options

AUTH	CSFPE	EXBK	FFD	FL/FR	FPE	INTGE	IPE
✓	✓	✓		✓	✓	✓	

Custom Modification Options

ADD_SHLF	ADDTK	CBO	CCO	CFNTD	CFP	CFRMO	CHGDRW	CLIP	CMAT	CND	CSDGBK	DRT	DRWSEC	DRWTK	EX	EX_OL ¹	FBFL	FD	
	✓	✓	✓	✓	✓	✓	✓	✓		✓	✓	✓	✓	✓	✓	✓	✓		

FDSRTBTM	FLUT ²	FTK	ID	IH	INVFRM	IW	LIGHT	MIP	OBRB	PFINBTMB	RD	RECTK	RECTK_6 ³	RECTKFR16	RH	ROSLUT ²	RT	
	✓	✓	✓	✓	✓	✓	✓	✓	✓	✓	✓	✓	✓	✓	✓	✓	✓	

RW	SBCADDY	SBCADDYSM	SCPDRW	SRT	STW	TD	TKP	TVR	UDBX	URT	VTK	WS	WTCB	WTKCUP	WTR
			✓					✓	✓		✓		✓	✓	✓

¹ Not available with extended stile both.

² Not available with 6" fluting.

³ Can only be recessed in the front, back, and/or one side only.

BASE QUARTER ROUND END SHELF

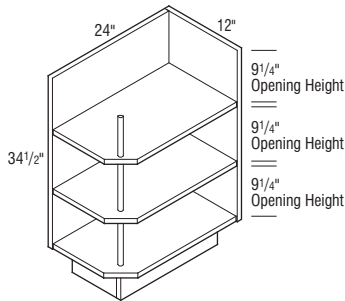

45° Angle (Right Angle Shown)

BQRES L or R	7.4	792	792	792	792	792	792	792

- L or R must be specified.
- 3/4" thick back and sides.
- Reduced Depths available in 1/4" increments from 9" to 23 3/4".
- Increased Depths available in 1/4" increments from 24 1/4" to 30".

Door & Drawer Options

AF	AOMBWB	CC	CG	GAMD	IFHG	MD	PRMD	PTOWB	SHMD	SPLITDR	SPLITDRWS	TCP

End Panel Options

AUTH	CSFPE	EXBK	FFD	FL/FR	FPE	INTGE	IPE

Custom Modification Options

ADD_SHLF	ADDTK	CBO	CCO	CFNTD	CFP	CFRMO	CHGDRW	CLIP	CMAT	CND	CSDGBK	DRT	DRWSEC	DRWTK	EX	EX_OL	FBFL	FD

FDSRTBTM	FLUT ²	FTK	ID	IH	INVFRM	IW	LIGHT	MIP	OBRB	PFINBTMB	RD	RECTK	RECTK_6	RECTKFR16	RH	ROSLUT ²	RT	
		✓				✓					✓							

RW	SBCADDY	SBCADDYSM	SCPDRW	SRT	STW	TD	TKP	TVR	UDBX	URT	VTK	WS	WTCB	WTKCUP	WTR
✓											✓				

BASE HALF ROUND END SHELF

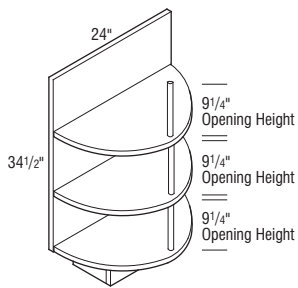

12" Radius

BHRES	7.4	792	792	792	792	792	792	792

- 3/4" thick back.
- Designed for use with Peninsula Base Cabinets.

Modifications
Are Not
Available

Desk File Drawer Base Cabinets

DESK FILE DRAWER BASE, 30" HIGH, 21" DEEP

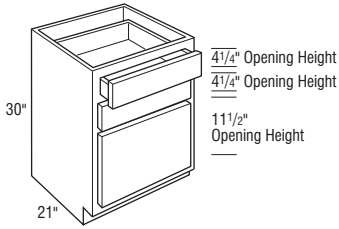

	Cubic Feet	1	2	3	4	5	6	7
DFD153021	7.1	1805	1890	1958	2064	2186	2388	2590
DFD183021	8.4	1887	1979	2048	2160	2287	2500	2713
DFD213021	9.6	2064	2164	2240	2363	2502	2732	2962
DFD243021	10.9	2175	2278	2361	2486	2633	2879	3125

- Lateral (side-to-side) Filing system installed.
- Increased Depth of 24" available.
- When an Inset or Beaded Inset style is selected, drawer fronts will be slab.

Door & Drawer Options

AF	AOMBWB	CC	CG	GAMD	IFHG	MD	PRMD	PTOWB	SHMD	SPLITDR	SPLITDRWS	TCP
----	--------	----	----	------	------	----	------	-------	------	---------	-----------	-----

End Panel Options

AUTH	CSFPE	EXBK	FFD	FL/FR	FPE	INTGE	IPE
✓	✓	✓	✓	✓	✓	✓	✓

Custom Modification Options

ADD_SHLF	ADDTK	CBO	CCO	CFNTD	CFP	CFRMO	CHGDRW	CLIP	CMAT	CND	CSDGBK	DRT	DRWSEC	DRWTK	EX	EX_OL	FBFL	FD	
		✓	✓	✓				✓								✓	✓		

FDSRTBTM	FLUT ¹	FTK	ID	IH	INVFRM	IW	LIGHT	MIP	OBRB	PFINBTMB	RD	RECTK	RECTK_6 ²	RECTKFRT6	RH	ROSFLUT	RT
	✓	✓	✓	✓	✓	✓	✓	✓	✓	✓	✓	✓	✓	✓	✓	✓	✓

RW	SBCADDY	SBCADDYSM	SCPDWR	SRT	STW	TD	TKP	TVR	UDBX	URT	VTK	WS	WTCO	WTKCUP	WTR
							✓				✓	✓			✓

¹ Not available with 6" fluting.

² 15" and 18" wide can only be recessed in the front, back, and/or one side only.

DESK FILE DRAWER BASE, 34 1/2" HIGH, 21" DEEP

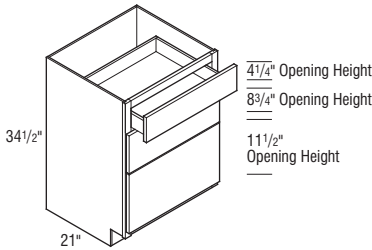

	Cubic Feet	1	2	3	4	5	6	7
DFD153421	8.1	2074	2175	2252	2373	2514	2747	2980
DFD183421	9.5	2170	2276	2357	2482	2629	2874	3119
DFD213421	11.0	2373	2486	2576	2716	2876	3143	3410
DFD243421	12.5	2501	2620	2715	2861	3031	3312	3593

- Lateral (side-to-side) Filing system installed.
- Increased Depths available in 3" increments from 24".

Door & Drawer Options

AF	AOMBWB	CC	CG	GAMD	IFHG	MD	PRMD	PTOWB	SHMD	SPLITDR	SPLITDRWS	TCP
----	--------	----	----	------	------	----	------	-------	------	---------	-----------	-----

End Panel Options

AUTH	CSFPE	EXBK	FFD	FL/FR	FPE	INTGE	IPE
✓	✓	✓	✓	✓	✓	✓	✓

Custom Modification Options

ADD_SHLF	ADDTK	CBO	CCO	CFNTD	CFP	CFRMO	CHGDRW	CLIP	CMAT	CND	CSDGBK	DRT	DRWSEC	DRWTK	EX	EX_OL	FBFL	FD	
		✓	✓	✓				✓								✓	✓		

FDSRTBTM	FLUT ¹	FTK	ID	IH	INVFRM	IW	LIGHT	MIP	OBRB	PFINBTMB	RD	RECTK	RECTK_6 ²	RECTKFRT6	RH	ROSFLUT	RT
	✓	✓	✓	✓	✓	✓	✓	✓	✓	✓	✓	✓	✓	✓	✓	✓	✓

RW	SBCADDY	SBCADDYSM	SCPDWR	SRT	STW	TD	TKP	TVR	UDBX	URT	VTK	WS	WTCO	WTKCUP	WTR
							✓				✓	✓			✓

¹ Not available with 6" fluting.

² 15" and 18" wide can only be recessed in the front, back, and/or one side only.

IH/RH availability charts starting on page G-40.
IW/RW availability charts starting on page G-46.

FURNITURE DRAWER, 6 3/4" HIGH, 24" DEEP

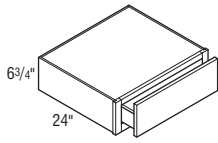

	Cubic Feet	1	2	3	4	5	6	7
FD1506.7524	2.1	1090	1144	1183	1246	1320	1442	1564
FD1806.7524	2.5	1145	1202	1245	1309	1388	1514	1640
FD2106.7524	2.9	1202	1262	1309	1377	1459	1593	1727
FD2406.7524	3.3	1263	1325	1373	1445	1532	1672	1812
FD2706.7524	3.7	1325	1391	1442	1516	1607	1753	1899
FD3006.7524	4.1	1391	1460	1513	1593	1688	1843	1998
FD3306.7524	4.4	1463	1535	1592	1674	1775	1938	2101
FD3606.7524	4.8	1535	1612	1669	1757	1861	2031	2201
FD3906.7524	5.2	1613	1693	1754	1845	1956	2134	2312
FD4206.7524	5.6	1694	1778	1843	1939	2056	2243	2430
FD4506.7524	5.9	1778	1866	1934	2035	2158	2355	2552
FD4806.7524	6.3	1866	1960	2031	2137	2266	2473	2680

- Reduced Depths available in 1/4" increments from 12" to 23 3/4".
- Increased Heights will not add a toekick.

Door & Drawer Options

AF	AOMBWB	CC	CG	GAMD	IFHG	MD	PRMD	PTOWB	SHMD	SPLITDR	SPLITDRWS	TCP
												✓

End Panel Options

AUTH	CSFPE	EXBK	FFD	FL/FR	FPE	INTGE	IPE
✓		✓		✓			

Custom Modification Options

ADD_SHLF	ADDTK	CBO	CCO	CFNTO	CFP	CFRMO	CHGDRW	CLIP	CMAT	CND	CSDGBK	DRT	DRWSEC	DRWTK	EX	EX_OL	FBFL	FD
	✓	✓	✓			✓		✓			✓				✓	✓		

FDSRTBTM	FLUT	FTK	ID	IH	INVFRM	IW	LIGHT	MIP	OBRB	PFINBTMB	RD	RECTK	RECTK_6	RECTKFR6	RH	ROSLUT	RT
	✓		✓	✓		✓		✓			✓						

RW	SBCADDY	SBCADDYSM	SCPDRW	SRT	STW	TD	TKP	TVR	UDBX	URT	VTK	WS	WTCB	WTKCUP	WTR
												✓			✓

Furniture Drawers

	Cubic Feet	1	2	3	4	5	6	7
FURNITURE DRAWER, 12" HIGH, 24" DEEP								
FD151224	3.5	1118	1174	1217	1281	1358	1481	1604
FD181224	4.1	1174	1233	1277	1345	1425	1555	1685
FD211224	4.7	1234	1295	1342	1412	1497	1632	1767
FD241224	5.4	1295	1359	1409	1482	1571	1715	1859
FD271224	6.0	1361	1427	1479	1556	1650	1801	1952
FD301224	6.6	1428	1500	1554	1634	1732	1892	2052
FD331224	7.2	1502	1576	1632	1719	1822	1988	2154
FD361224	7.9	1576	1655	1715	1805	1913	2088	2263
FD391224	8.4	1655	1737	1800	1893	2006	2188	2370
FD421224	9.1	1737	1823	1888	1988	2107	2300	2493
FD451224	9.7	1824	1914	1983	2086	2212	2414	2616
FD481224	10.3	1915	2010	2083	2192	2324	2535	2746

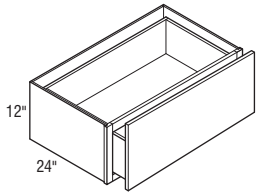

- Reduced Depths available in 1/4" increments from 12" to 23 3/4".
- Increased Heights will not add a toekick.

Door & Drawer Options

AF	AOMBWB	CC	CG	GAMD	IFHG	MD	PRMD	PTOWB	SHMD	SPLITDR	SPLITDRWS	TCP
												✓

End Panel Options

AUTH	CSFPE	EXBK	FFD	FL/FR	FPE	INTGE	IPE
✓		✓		✓			

Custom Modification Options

ADD	SHLF	ADDTK	CBO	CCO	CFNTO	CFP	CFRMO	CHGDRW	CLIP	CMAT	CND	CSDGBK	DRT	DRWSEC	DRWTK	EX	EX_OL	FBFL	FD	
			✓	✓	✓		✓		✓			✓					✓	✓		
FDSRTBTM	FLUT	FTK	ID	IH	INVFRM	IW	LIGHT	MIP	OBRB	PFINBTMB	RD	RECTK	RECTK_6	RECTKFRT6	RH	ROSLUT	RT			
		✓	✓	✓		✓		✓			✓									
RW	SBCADDY	SBCADDYSM	SCPDRW	SRT	STW	TD	TKP	TVR	UDBX	URT	VTK	WS	WTCD	WTKCUP	WTR					
												✓			✓					

IH/RH availability charts starting on page G•40.
IW/RW availability charts starting on page G•46.

FURNITURE DRAWER WINDOW BENCH, 18" HIGH, 24" DEEP

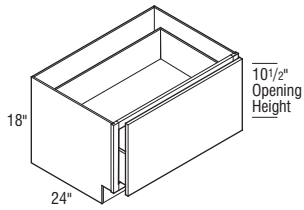

	Cubic Feet	1	2	3	4	5	6	7
FDWB151824	4.9	1196	1254	1297	1367	1448	1580	1712
FDWB181824	5.8	1254	1315	1362	1434	1520	1658	1796
FDWB211824	6.7	1315	1381	1432	1505	1597	1741	1885
FDWB241824	7.6	1381	1450	1501	1581	1673	1827	1981
FDWB271824	8.5	1450	1522	1578	1660	1757	1919	2081
FDWB301824	9.4	1522	1598	1656	1742	1848	2015	2182
FDWB331824	10.3	1598	1674	1738	1828	1940	2118	2296
FDWB361824	11.2	1674	1759	1826	1920	2035	2223	2411
FDWB391824	12.1	1763	1851	1918	2019	2139	2334	2529
FDWB421824	13.0	1851	1944	2013	2117	2245	2451	2657
FDWB451824	13.9	1945	2041	2115	2225	2359	2576	2793
FDWB481824	14.8	2041	2144	2220	2337	2478	2704	2930

- Reduced Depths available in 1/4" increments from 12" to 23 3/4".
- Toekick will remain when increasing or reducing heights.

Door & Drawer Options

AF	AOMBWB	CC	CG	GAMD	IFHG	MD	PRMD	PTOWB	SHMD	SPLITDR	SPLITDRWS ¹	TCP
											✓	

End Panel Options

AUTH	CSFPE	EXBK	FFD	FL/FR	FPE	INTGE	IPE
	✓	✓		✓	✓	✓	✓

Custom Modification Options

ADD	SHLF	ADDTK	CBO	CCO	CFNTO	CFP	CFRMO	CHGDRW	CLIP	CMAT	CND	CSDGBK	DRT	DRWSEC	DRWTK	EX	EX_OL	FBFL	FD
		✓	✓	✓	✓	✓	✓	✓	✓	✓	✓	✓	✓	✓	✓	✓	✓	✓	✓

FDSRTBTM	FLUT ²	FTK	ID	IH	INVFRM	IW ³	LIGHT	MIP	OBRB	PFINBTMB	RD	RECTK	RECTK_6	RECTKFRT6	RH	ROSFLUT ⁴	RT
	✓	✓	✓	✓	✓	✓	✓	✓	✓	✓	✓	✓	✓	✓	✓	✓	✓

RW	SBCADDY	SBCADDYSM	SCPDRW	SRT	STW	TD	TKP	TVR	UDBX	URT	VTK	WS	WTCB	WTKCUP	WTR
							✓	✓			✓	✓			

¹ Not available on 15"-21" wide.

² 6" fluting not available on 15" or 18" wide. Fluting both 6" also not available on 21" wide.

³ Not available on 36" or 48" wide.

⁴ Fluting both not available on 15" or 18" wide.

Hutch Base Cabinets

	Cubic Feet	1	2	3	4	5	6	7	
HUTCH BASE, 34 1/2" HIGH, 24" DEEP	HB30	17.4	2273	2382	2470	2607	2741	2997	3253
	HB36	20.7	2361	2470	2566	2704	2847	3111	3375
	HB42	24.0	2457	2575	2661	2812	2961	3234	3507
	HB48	27.3	2633	2764	2860	3026	3180	3470	3760

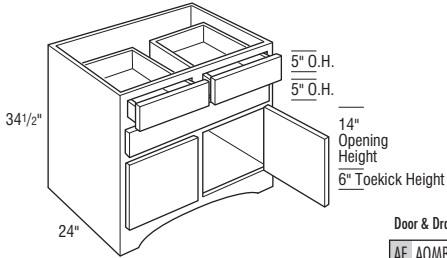
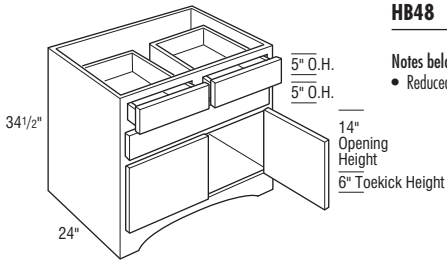

Notes below apply to all products in section above:
 • Reduced Depths available in 1/4" increments from 12" to 23 3/4".

Door & Drawer Options

AF	AOMBWB	CC	CG	GAMD	IFHG	MD	PRMD	PTOWB	SHMD	SPLITDR ¹	SPLITDRWS	TCP
		✓	✓	✓	✓	✓	✓		✓	✓		

End Panel Options

AUTH	CSFPE	EXBK	FFD	FL/FR	FPE	INTGE	IPE
✓	✓	✓	✓	✓	✓	✓	✓

Custom Modification Options

ADD	SHLF	ADDTK	CBO	CCO	CFNTO	CFP	CFRMO	CHGDRW	CLIP	CMAT	CND	CSDGBK	DRT	DRWSEC ²	DRWTK ¹	EX	EX_OL	FBFL	FD
			✓	✓	✓	✓	✓		✓		✓	✓	✓	✓	✓	✓	✓	✓	✓

FDSRTBTM	FLUT ³	FTK ⁴	ID	IH	INVFRM	IW	LIGHT	MIP	OBRB	PFINBTMB	RD	RECTK	RECTK_6	RECTKFRT6	RH	ROSELUT	RT
	✓	✓		✓				✓	✓		✓					✓	✓

RW	SBCADDY	SBCADDYSM	SCPDRW	SRT	STW	TD	TKP	TVR	UBX	URT	VTK	WS	WTCO	WTKCUP	WTR
			✓			✓		✓			✓	✓	✓	✓	✓

¹ Not available on 42" or 48" wide.
² Only available on 36"-48" wide.
³ Fluting both 6" not available on 30" wide.
⁴ Not available on FTKAV and style B-L.

IH/RH availability charts starting on page G-40.
 IW/RW availability charts starting on page G-46.

BASE OPEN CABINET with PLAIN BACK, 34 1/2" HIGH, 24" DEEP

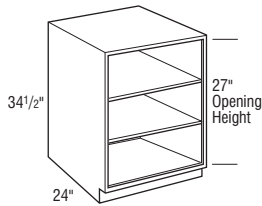

	Cubic Feet	1	2	3	4	5	6	7
BOCP15	9.1	1013	1061	1095	1157	1219	1333	1447
BOCP18	10.8	1061	1111	1148	1211	1282	1404	1526
BOCP24	14.1	1427	1497	1548	1631	1733	1891	2049
BOCP30	17.4	1692	1770	1839	1937	2035	2222	2409
BOCP36	20.7	1822	1908	1981	2093	2191	2398	2605

Notes below apply to all products in section above:

- Matching Interior Plywood (MIP) standard.
- If ordered with Hewn Technique, will not feature sand-through characteristics.
- To change the top rail valance, specify one of the Top Valance Rail modifications.
- Includes two full depth adjustable shelves.
- Reduced Depths available in 1/4" increments from 6" to 23 3/4".
- Increased Depths available in 1/4" increments from 24 1/4" to 30".

Door & Drawer Options

AF	AOMBWB	CC	CG	GAMD	IFHG	MD	PRMD	PTOWB	SHMD	SPLITDR	SPLITDRWS	TCP
----	--------	----	----	------	------	----	------	-------	------	---------	-----------	-----

End Panel Options

AUTH	CSFPE	EXBK	FFD	FL/FR	FPE	INTGE	IPE
------	-------	------	-----	-------	-----	-------	-----

Custom Modification Options

ADD	SHLF	ADDTK	CBO	CCO	CFNTD	CFP	CFRMO	CHGDRW	CLIP	CMAT	CND	CSDGBK	DRT	DRWSEC	DRWTK	EX	EX_OL	FBFL	FD
-----	------	-------	-----	-----	-------	-----	-------	--------	------	------	-----	--------	-----	--------	-------	----	-------	------	----

FDSRTBTM	FLUT ¹	FTK	ID	IH	INVFRM	IW	LIGHT	MIP	OBRB	PFINBTMB	RD	RECTK	RECTK_6	RECTKFRT6	RH	ROSFLUT	RT
----------	-------------------	-----	----	----	--------	----	-------	-----	------	----------	----	-------	---------	-----------	----	---------	----

RW	SBCADDY	SBCADDYSM	SCPDRW	SRT	STW	TD	TKP	TVR	UDBX	URT	VTK	IWS	WTCB	WTKCUP	WTR
----	---------	-----------	--------	-----	-----	----	-----	-----	------	-----	-----	-----	------	--------	-----

¹ Not available with 6" fluting.

BASE OPEN CABINET with CAR SIDING BACK, 34 1/2" HIGH, 24" DEEP

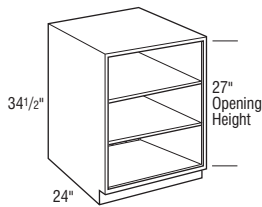

	Cubic Feet	1	2	3	4	5	6	7
BOCB15	9.1	1293	1341	1375	1437	1499	1613	1727
BOCB18	10.8	1341	1391	1428	1491	1562	1684	1806
BOCB24	14.1	1707	1777	1828	1911	2013	2171	2329
BOCB30	17.4	1972	2050	2119	2217	2315	2502	2689
BOCB36	20.7	2102	2188	2261	2373	2471	2678	2885

Notes below apply to all products in section above:

- Matching Interior Plywood (MIP) standard.
- The interior back of cabinet will be car siding back.
- If ordered with Hewn Technique, will not feature sand-through characteristics.
- To change the top rail valance, specify one of the Top Valance Rail modifications.
- Includes two full depth adjustable shelves.
- Reduced Depths available in 1/4" increments from 6" to 23 3/4".
- Increased Depths available in 1/4" increments from 24 1/4" to 30".

Door & Drawer Options

AF	AOMBWB	CC	CG	GAMD	IFHG	MD	PRMD	PTOWB	SHMD	SPLITDR	SPLITDRWS	TCP
----	--------	----	----	------	------	----	------	-------	------	---------	-----------	-----

End Panel Options

AUTH	CSFPE	EXBK	FFD	FL/FR	FPE	INTGE	IPE
------	-------	------	-----	-------	-----	-------	-----

Custom Modification Options

ADD	SHLF	ADDTK	CBO	CCO	CFNTD	CFP	CFRMO	CHGDRW	CLIP	CMAT	CND	CSDGBK	DRT	DRWSEC	DRWTK	EX	EX_OL	FBFL	FD
-----	------	-------	-----	-----	-------	-----	-------	--------	------	------	-----	--------	-----	--------	-------	----	-------	------	----

FDSRTBTM	FLUT ¹	FTK	ID	IH	INVFRM	IW	LIGHT	MIP	OBRB	PFINBTMB	RD	RECTK	RECTK_6	RECTKFRT6	RH	ROSFLUT	RT
----------	-------------------	-----	----	----	--------	----	-------	-----	------	----------	----	-------	---------	-----------	----	---------	----

RW	SBCADDY	SBCADDYSM	SCPDRW	SRT	STW	TD	TKP	TVR	UDBX	URT	VTK	IWS	WTCB	WTKCUP	WTR
----	---------	-----------	--------	-----	-----	----	-----	-----	------	-----	-----	-----	------	--------	-----

¹ Not available with 6" fluting.

Base Open Cabinets

BASE OPEN CABINET with PLAIN BACK and DRAWER, 34 1/2" HIGH, 24" DEEP

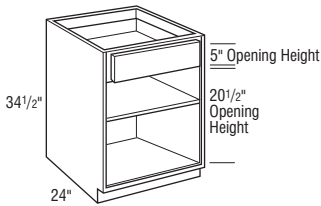

	Cubic Feet	1	2	3	4	5	6	7
BODP15	9.1	1196	1258	1303	1369	1434	1570	1706
BODP18	10.8	1230	1284	1326	1395	1465	1601	1737
BODP24	14.1	1650	1727	1776	1869	1982	2162	2342
BODP30	17.4	1883	1973	2037	2151	2254	2464	2674
BODP36	20.7	1982	2077	2151	2266	2382	2598	2814

Notes below apply to all products in section above:

- Includes one full depth adjustable shelf.
- Matching Interior Plywood (MIP) standard.
- If ordered with Hewn Technique, will not feature sand-through characteristics.
- To change the top rail valance, specify one of the Top Valance Rail modifications.

Door & Drawer Options

AF	AOMBWB	CC	CG	GAMD	IFHG	MD	PRMD	PTOWB	SHMD	SPLITDR	SPLITDRWS ¹	TCP
											✓	

End Panel Options

AUTH	CSFPE	EXBK	FFD	FL/FR	FPE	INTGE	IPE
✓	✓	✓	✓	✓	✓	✓	✓

Custom Modification Options

ADD_SHLF	ADDTK	CBO	CCO	CFNT0	CFP	CFRMO	CHGDRW	CLIP	CMAT	CND	CSDGBK	DRT	DRWSEC	DRWTK	EX	EX_OL	FBFL	FD
		✓	✓	✓	✓	✓		✓			✓			✓	✓	✓		

FDSRTBTM	FLUT ²	FTK	ID	IH	INVFRM	IW ³	LIGHT	MIP	OBRB	PFINBTMB	RD	RECTK	RECTK_6	RECTKFRT6	RH	ROSLUT	RT
✓	✓	✓	✓	✓	✓	✓				✓	✓	✓	✓	✓	✓	✓	✓

RW	SBCADDY	SBCADDYSM	SCPDRW	SRT	STW	TD	TKP	TVR ⁴	UDBX ¹	URT	VTK	WS	WTCD	WTKCUP ⁵	WTR
	✓	✓	✓	✓	✓	✓	✓	✓	✓	✓	✓	✓	✓	✓	✓

¹ Not available on 15"-18" wide.

² 6" fluting not available on 15" wide and FLUT6B is only available on 24" wide.

³ Not available on 24" wide.

⁴ Not available on 18" wide.

⁵ Only available on 18" and 36" wide. Only available on 36" wide when used in conjunction with SPLITDRWS modification.

BASE OPEN CABINET with CAR SIDING BACK and DRAWER, 4 1/2" HIGH, 24" DEEP

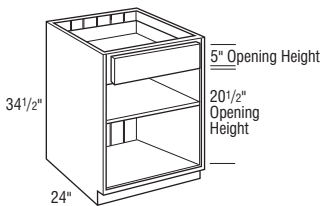

	Cubic Feet	1	2	3	4	5	6	7
BODB15	9.1	1476	1538	1583	1649	1714	1850	1986
BODB18	10.8	1510	1564	1606	1675	1745	1881	2017
BODB24	14.1	1930	2007	2056	2149	2262	2442	2622
BODB30	17.4	2163	2253	2317	2431	2534	2744	2954
BODB36	20.7	2262	2357	2431	2546	2662	2878	3094

Notes below apply to all products in section above:

- Includes one full depth adjustable shelf.
- Matching Interior Plywood (MIP) standard.
- The interior back of cabinet will be car siding back.
- If ordered with Hewn Technique, will not feature sand-through characteristics.
- To change the top rail valance, specify one of the Top Valance Rail modifications.

Door & Drawer Options

AF	AOMBWB	CC	CG	GAMD	IFHG	MD	PRMD	PTOWB	SHMD	SPLITDR	SPLITDRWS ¹	TCP
											✓	

End Panel Options

AUTH	CSFPE	EXBK	FFD	FL/FR	FPE	INTGE	IPE
✓	✓	✓	✓	✓	✓	✓	✓

Custom Modification Options

ADD_SHLF	ADDTK	CBO	CCO	CFNT0	CFP	CFRMO	CHGDRW	CLIP	CMAT	CND	CSDGBK	DRT	DRWSEC	DRWTK	EX	EX_OL	FBFL	FD
		✓	✓	✓	✓	✓		✓			✓			✓	✓	✓		

FDSRTBTM	FLUT ²	FTK	ID	IH	INVFRM	IW ³	LIGHT	MIP	OBRB	PFINBTMB	RD	RECTK	RECTK_6	RECTKFRT6	RH	ROSLUT	RT
✓	✓	✓	✓	✓	✓	✓				✓	✓	✓	✓	✓	✓	✓	✓

RW	SBCADDY	SBCADDYSM	SCPDRW	SRT	STW	TD	TKP	TVR ⁴	UDBX ¹	URT	VTK	WS	WTCD	WTKCUP ⁵	WTR
	✓	✓	✓	✓	✓	✓	✓	✓	✓	✓	✓	✓	✓	✓	✓

¹ Not available on 15"-18" wide.

² 6" fluting not available on 15" wide and FLUT6B is only available on 24" wide.

³ Not available on 24" wide.

⁴ Not available on 18" wide.

⁵ Only available on 18" and 36" wide. Only available on 36" wide when used in conjunction with SPLITDRWS modification.

IH/RH availability charts starting on page G-40.
IW/RW availability charts starting on page G-46.

Base Message Center Cabinets

BASE MESSAGE CENTER, 30" HIGH, 3" DEEP

L O G I X

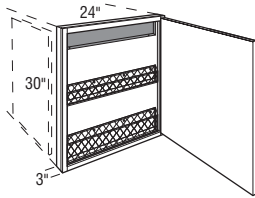

Cubic Feet	1	2	3	4	5	6	7	
BMC24 L or R	12.2	1695	1768	1838	1910	1946	1981	2016

- Finished Flush Ends standard.
- Includes magazine holder, bulletin board and mail holder.
- Cabinet recommended to be hinged on wall side.
- Door will open 90° without decorative hardware.
- For proper installation, adjacent cabinet must have flush ends or 3/32" skin applied.
- Embellishments or overlay fillers can be used on side of cabinet to add a decorative touch.
- Increased Depths available in 1/4" increments from 3 1/4" to 30".
- Not available on Inset and Beaded Inset styles.

Door & Drawer Options

AF	AOMBWB	CC	CG	GAMD	IFHG	MD	PRMD	PTOWB	SHMD	SPLITDR	SPLITDRWS	TCP
			✓	✓		✓	✓		✓			✓

End Panel Options

AUTH	CSFPE	EXBK	FFD	FL/FR	FPE	INTGE	IPE
	✓						

Custom Modification Options

ADD_SHLF	ADDTK	CBO	CCO	CFNT0	CFP	CFRMO	CHGDRW	CLIP	CMAT	CND	CSDGBK	DRT	DRWSEC	DRWTK	EX	EX_OL	FBFL	FD
		✓	✓	✓		✓				✓					✓	✓		

FDSRTBTM	FLUT	FTK	ID	IH	INVFRM	IW	LIGHT	MIP	OBRB	PFINBTMB	RD	RECTK	RECTK_6	RECTKFR16	RH	ROSFLUT	RT
		✓	✓					✓	✓								

RW	SBCADDY	SBCADDYSM	SCPDRW	SRT	STW	TD	TKP	TVR	UDBX	URT	VTK	WS	WTCB	WTKCUP	WTR
												✓			✓

Notes









How to Use Your Diamond Edge Price List

Your Diamond Edge price guide contains charts with prices for each cabinetry product, arranged according to an alphabetical code. Use the chart below to determine the price code for your preferred cabinetry style.

Then refer to the various sections of this binder to find the types and sizes of cabinets required. Read across each chart to the column that corresponds to your style's price code to determine the price for each unit.

For example, if you want a utility wall cabinet that is 12" wide and 84" high in the Karis Cherry style, you would

- Find the price code for Karis Cherry ("3" in the chart below)
- Refer to the Tall Cabinets section of this binder
- Locate product code U128412 L or R (U = utility wall, 12 = width in inches, 84 = height in inches)
- Read across the chart in the same row to column 3 to find the price for this model in Karis Cherry

Door Styles	Alder	Cherry	Maple	MDF	Quartersawn Oak	Rustic Alder	Walnut
Brooks	3	5	3		5	3	6
Brooks Beaded Inset	3+15%	5+15%	3+15%		5+15%	3+15%	6+15%
Brooks Inset	3+15%	5+15%	3+15%		5+15%	3+15%	6+15%
Caldera 	3	5	3		5	3	6
Daxton	2	4	2		4	2	6
Daxton Beaded Inset	2+15%	4+15%	2+15%		4+15%	2+15%	6+15%
Daxton Inset	2+15%	4+15%	2+15%		4+15%	2+15%	6+15%
Gunther	1	3	1		3	1	5
Gunther Beaded Inset	1+15%	3+15%	1+15%		3+15%	1+15%	5+15%
Gunther Inset	1+15%	3+15%	1+15%		3+15%	1+15%	5+15%
Karis	1	3	1		3	1	5
Karis Beaded Inset	1+15%	3+15%	1+15%		3+15%	1+15%	5+15%
Karis Inset	1+15%	3+15%	1+15%		3+15%	1+15%	5+15%
Langley	5	6	5		6	5	7
Langley Beaded Inset	5+15%	6+15%	5+15%		6+15%	5+15%	7+15%
Langley Inset	5+15%	6+15%	5+15%		6+15%	5+15%	7+15%
Montgomery 	1	3	1		3	1	5
Montgomery Beaded Inset 	1+15%	3+15%	1+15%		3+15%	1+15%	5+15%
Montgomery Inset 	1+15%	3+15%	1+15%		3+15%	1+15%	5+15%
Shona	1	3	1		3	1	5
Shona Beaded Inset	1+15%	3+15%	1+15%		3+15%	1+15%	5+15%
Shona Inset	1+15%	3+15%	1+15%		3+15%	1+15%	5+15%
Sumner 	3	5	3		5	3	6
Tackett	2	4	2		4	2	6
Tackett Beaded Inset	2+15%	4+15%	2+15%		4+15%	2+15%	6+15%
Tackett Inset	2+15%	4+15%	2+15%		4+15%	2+15%	6+15%
Trystan 	4	6	4	1	6		7
Trystan Beaded Inset 				1+15%			
Trystan Inset 				1+15%			
Vesta	2	4	2		4	2	6
Vesta Beaded Inset	2+15%	4+15%	2+15%		4+15%	2+15%	6+15%
Vesta Inset	2+15%	4+15%	2+15%		4+15%	2+15%	6+15%
Wells 	4	6	4		6	4	7

Diamond Edge Modification Option Descriptions

Your Diamond Edge price guide contains charts with modification option codes for each applicable cabinetry product. Reference the listing below to identify the modification description.

Door & Drawer Options

Option	Description
AF	Aluminum Door
CC	Craftsman Door
CG	Cut-for-glass
GAMD	Gallery Mullion Door
IFHG	Inset Finial Hinges
MD	Mullion Door
MFO	Modified Full Overlay
PRMD	Prairie Mullion Door
SGLPN	Single Panel Tall Door
SHMD	Shaker Mullion Door
SPLITDR	Split Doors

End Panel Options

Option	Description
AUTH	Authentic Flush End
CSFPE	Car Siding Flush Panel End
EXBK	End Extended Back
FFD	Face Frame and Door on End
FL/FR	Finished Ends
FPE	Flush Panel End
INTGE	Integral End
IPE	Inset Panel Ends

Custom Modification Options

Option	Description
ATTK	Attach Toekick
CBO	Cabinet Box Only
CCO	Cabinet Case Only
CFNTD	Cabinet Front Only
CFRMO	Cabinet Frame Only
CLIP	Clipped Corner
CND	Cabinet No Door
CSDGBK	Car Siding Back
DRT	Deep Roll Trays
DRWTK	Toekick Drawer
EX	Extended Stile
EX_OL	Extended Stile with Overlay
FLUT	Fluting
FTK	Flush Toekick
ID	Increased Depth
IH	Increased Height
IW	Increased Width
LIGHT	Lighting
MIP	Matching Interior
OBRB	Open Bottom Rail Base
RD	Reduced Depth
RECTK	Recessed Toekick
RH	Reduced Height
ROSFLOT	Rose Fluting
RT	Roll Trays
SRT	Scooped Roll Tray
TD	Tray Divider
TKP	Toekick Pedestal
TVR	Top Valance Rail
VTK	Void Toekick
WS	Wide Stiles
WTR	Wide Top Rail

NEW UTILITY, 66", 84", 87", 90", 93", 96", 102", or 108" HIGH, 12" DEEP

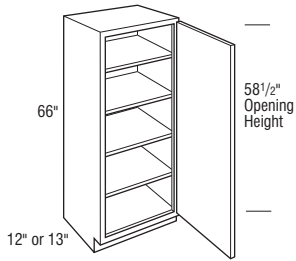

Cubic Feet	1	2	3	4	5	6	7
U126612 L or R	7.5	1765	1851	1917	2022	2132	2526
U156612 L or R	9.5	1866	1962	2030	2138	2265	2679
U186612 L or R	10.8	1978	2075	2148	2270	2393	2841
U216612 L or R	12.4	2105	2210	2288	2421	2548	3016
U246612 L or R	14.1	2236	2346	2429	2565	2706	3214

- Includes four adjustable shelves.
- Doors will include two center panels divided by a horizontal rail.
- Inset and Beaded Inset Door Styles are a standard 13" deep.
- Full Overlay Styles:
 - Increased Depths available in 1/4" increments from 12 1/4" to 30".
 - Reduced Depths available in 1/4" increments from 6" to 11 3/4".
- Inset and Beaded Inset Styles:
 - Increased Depths available in 1/4" increments from 13 1/4" to 30".
 - Reduced Depths available in 1/4" increments from 6" to 12 3/4".
- Recessed Toekick on ends must be specified if required.

Door & Drawer Options

AF	CC	CG	GAMD	IFHG	MD	MFO	PRMD	SGLPN	SHMD	SPLITDR
	✓			✓		✓		✓		

End Panel Options

AUTH	CSFPE	EXBK	FFD	FL/FR	FPE	INTGE	IPE
✓	✓	✓	✓	✓	✓	✓	✓

Custom Modification Options

ATTK	CBO	CCO	CFNT0	CFRMO	CLIP	CND	CSDGBK	DRT	DRWTK	EX	EX_OL	FLUT ¹	FTK ²	ID	IH	IW	LIGHT	MIP	OBRB
	✓	✓	✓	✓	✓	✓	✓		✓	✓	✓	✓	✓	✓	✓	✓	✓	✓	✓

RD	RECTK	RH	ROSFLUT ¹	RT	SRT	TD	TKP	TVR ³	VTK	IWS ⁴	WTR
✓	✓		✓	✓		✓	✓	✓	✓	✓	✓

¹ Fluting both not available on 12" wide. Not available with 6" fluting.

² FTKAV and style B-L are not available on 12" wide.

³ Not available on 12" wide except with TVRVV.

⁴ Wide stile both 3" not available on 12" wide.

Utility Cabinets

UTILITY, 66", 84", 87", 90", 93", 96", 102", or 108" HIGH, 12" DEEP (cont'd)

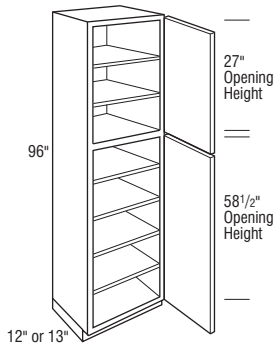
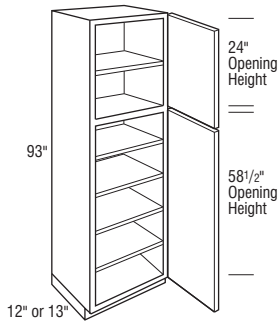
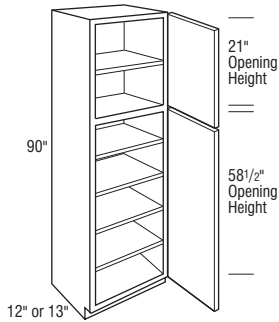
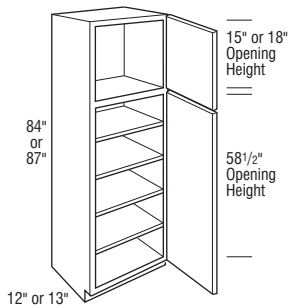

	Cubic Feet	1	2	3	4	5	6	7
U128412 L or R	9.7	1998	2096	2175	2292	2415	2631	2847
U158412 L or R	11.8	2123	2225	2309	2431	2561	2800	3039
U188412 L or R	14.0	2241	2351	2432	2566	2717	2971	3225
U218412 L or R	16.1	2389	2511	2594	2736	2891	3165	3439
U248412 L or R	18.3	2537	2661	2753	2908	3073	3362	3651
U128712 L or R	10.0	2102	2207	2283	2412	2542	2770	2998
U158712 L or R	12.3	2227	2337	2421	2554	2699	2945	3191
U188712 L or R	14.5	2359	2473	2558	2703	2855	3122	3389
U218712 L or R	16.7	2514	2640	2727	2882	3037	3321	3605
U248712 L or R	18.9	2665	2796	2896	3057	3230	3532	3834

• Includes four adjustable shelves.

U129012AH L or R	10.4	2206	2314	2396	2528	2665	2911	3157
U159012AH L or R	12.7	2332	2453	2537	2673	2831	3090	3349
U189012AH L or R	15.0	2473	2594	2685	2837	2991	3271	3551
U219012AH L or R	17.3	2631	2762	2860	3026	3185	3478	3771
U249012AH L or R	19.6	2795	2933	3036	3206	3383	3700	4017

• AH represents upper section alignment with doors on 24" or 27" high cabinets.

• Includes five adjustable shelves.

• Toekick shipped attached unless otherwise specified.

U129312AH L or R	10.7	2319	2432	2519	2658	2807	3066	3325
U159312AH L or R	13.1	2468	2590	2677	2826	2991	3262	3533
U189312AH L or R	15.5	2614	2742	2837	2995	3157	3451	3745
U219312AH L or R	17.8	2784	2917	3026	3195	3363	3668	3973
U249312AH L or R	20.2	2957	3099	3211	3387	3570	3902	4234

• AH represents upper section alignment with doors on 24" or 27" high cabinets.

• Includes five adjustable shelves.

• Shipped with loose toe space unless Attach Toekick or Flush Toekick is specified.

U129612 L or R	11.0	2436	2553	2644	2789	2945	3224	3503
U159612 L or R	13.5	2603	2727	2818	2977	3146	3438	3730
U189612 L or R	16.0	2753	2887	2991	3154	3323	3633	3943
U219612 L or R	18.4	2928	3073	3184	3363	3537	3864	4191
U249612 L or R	20.9	3117	3269	3383	3570	3758	4105	4452

• Includes six adjustable shelves.

• Shipped with loose toe space unless Attach Toekick or Flush Toekick is specified.

• Flush Toekick option not available in conjunction with Wide Top Rail unless loose Flush Toekick is specified.

Notes below apply to all products in section above:

• Large opening on tall doors will include two center panels divided by a horizontal rail.

• Inset and Beaded Inset Door Styles are a standard 13" deep.

• Full Overlay Styles:

– Increased Depths available in 1/4" increments from 12 1/4" to 30".

– Reduced Depths available in 1/4" increments from 6" to 11 3/4".

• Inset and Beaded Inset Styles:

– Increased Depths available in 1/4" increments from 13 1/4" to 30".

– Reduced Depths available in 1/4" increments from 6" to 12 3/4".

• Recessed Toekick on ends must be specified if required.

Door & Drawer Options

AF	CC	CG	GAMD ¹	IFHG	MD ¹	MFO	PRMD ²	SGLPN	SHMD ¹	SPLITDR
✓	✓	✓	✓	✓	✓	✓	✓	✓	✓	✓

End Panel Options

AUTH	CSFPE	EXBK	FFD	FL/FR	FPE	INTGE	IPE
✓	✓	✓	✓	✓	✓	✓	✓

Custom Modification Options

ATTK ³	CBO	CCO	CFNTO	CFRMO	CLIP ⁴	CND	CSDGBK	DRT	DRWTK	EX	EX_OL	FLUT ⁵	FTK ⁶	ID	IH ⁷	IW ⁸	LIGHT	MIP	OBRB	
✓	✓	✓	✓	✓	✓	✓	✓	✓	✓	✓	✓	✓	✓	✓	✓	✓	✓	✓	✓	✓

RD	RECTK ⁹	RH	ROSLUT	RT	SRT	TD ¹	TKP ¹⁰	TVR ¹¹	VTK	WS	WTR
✓	✓	✓	✓	✓	✓	✓	✓	✓	✓	✓	✓

¹ Only available on top section.

² Not available on 12" wide. Only available on top section.

³ Only available on 93"-96" high.

⁴ Not available on 12" wide.

⁵ Not available with 6" fluting.

⁶ FTKAV and style B-L not available on 12" wide.

⁷ Not available on 96" high.

⁸ Not available on 24" wide.

⁹ Only available on RECTK.L.R.BK.

¹⁰ Not available on 93"-96" high.

¹¹ Not available on 12" wide.

IH/RH availability charts starting on page G-40.
IW/RW availability charts starting on page G-46.

UTILITY, 66", 84", 87", 90", 93", 96", 102", or 108" HIGH, 12" DEEP (cont'd)

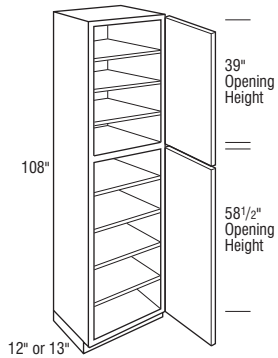
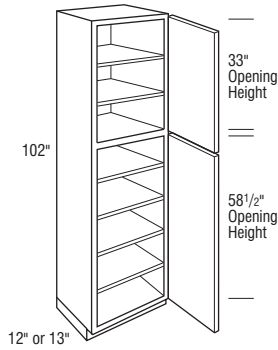

	Cubic Feet	1	2	3	4	5	6	7
U1210212 L or R	20.3	4755	4917	5044	5245	5461	5848	6235
U1510212 L or R	23.6	4987	5159	5285	5506	5740	6145	6550
U1810212 L or R	27.0	5195	5381	5525	5751	5986	6416	6846
U2110212 L or R	30.4	5438	5639	5793	6041	6283	6736	7189
U2410212 L or R	33.8	5700	5911	6069	6328	6589	7071	7553

• Includes six adjustable shelves.

U1210812 L or R	21.4	5278	5458	5598	5822	6062	6492	6922
U1510812 L or R	24.9	5535	5726	5866	6111	6371	6821	7271
U1810812 L or R	28.5	5766	5973	6133	6384	6644	7122	7600
U2110812 L or R	32.1	6036	6259	6430	6706	6974	7477	7980
U2410812 L or R	35.6	6327	6561	6736	7024	7314	7848	8382

• Includes seven adjustable shelves.

Notes below apply to all products in section above:

- Shipped with loose toe space unless Attach Toekick or Flush Toekick is specified.
- Large opening on tall doors will include two center panels divided by a horizontal rail.
- Inset and Beaded Inset Door Styles are a standard 13" deep.
- Full Overlay Styles:
 - Increased Depths available in 1/4" increments from 12 1/4" to 26".
 - Reduced Depths available in 1/4" increments from 6" to 11 3/4".
- Inset and Beaded Inset Styles:
 - Increased Depths available in 1/4" increments from 13 1/4" to 26".
 - Reduced Depths available in 1/4" increments from 6" to 12 3/4".
- Recessed Toekick on ends must be specified if required.
- Finish Flushed Ends standard.

Door & Drawer Options

AF	CC	CG	GAMD ¹	IFHG	MD ¹	MFO	PRMD ²	SGLPN	SHMD ¹	SPLITDR
✓	✓	✓	✓	✓	✓	✓	✓	✓	✓	✓

End Panel Options

AUTH	CSFPE	EXBK ³	FFD	FL/FR	FPE	INTGE	IPE
✓	✓	✓	✓	✓	✓	✓	✓

Custom Modification Options

ATTK	CBD	CCO	CFNTO	CFRMO	CLIP	CND	CSDGBK	DRT	DRWTK ⁴	EX	EX_OL	FLUT ⁵	FTK ⁶	ID	IH ⁷	IW ⁸	LIGHT	MIP	OBRB
✓	✓	✓	✓	✓	✓	✓	✓	✓	✓	✓	✓	✓	✓	✓	✓	✓	✓	✓	✓

RD	RECTK	RH ⁷	ROSLUT ⁵	RT	SRT	TD ¹	TKP	TVR ⁹	VTK	WS	WTR
✓	✓	✓	✓	✓	✓	✓	✓	✓	✓	✓	✓

¹ Only available on top section.

² Not available on 12" wide. Only available on top section.

³ This modification will allow the end to extend back to a maximum of 30" deep.

⁴ Only available when used in conjunction with attach toekick modification.

⁵ Not available with 6" fluting.

⁶ FTKAV and style B-L not available on 12" wide.

⁷ Not available on 108" high.

⁸ Not available on 24" wide.

⁹ Not available on 12" wide.

Utility Cabinets

NEW UTILITY, 66", 84", 87", 90", 93", 96", 102", or 108" HIGH, 12" DEEP (cont'd)

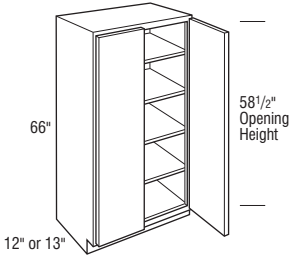

	Cubic Feet	1	2	3	4	5	6	7
U246612	14.1	2869	3011	3096	3264	3493	3815	4137
U276612	15.7	3130	3284	3387	3574	3795	4144	4493
U306612	17.4	3394	3557	3684	3886	4098	4478	4858
U336612	19.0	3493	3660	3792	3999	4221	4610	4999
U366612	20.6	3591	3763	3902	4112	4336	4742	5148

- Includes four adjustable shelves.
- Doors will include two center panels divided by a horizontal rail.
- Inset and Beaded Inset Door Styles are a standard 13" deep.
- Full Overlay Styles:
 - Increased Depths available in 1/4" increments from 12 1/4" to 30".
 - Reduced Depths available in 1/4" increments from 6" to 11 3/4".
- Inset and Beaded Inset Styles:
 - Increased Depths available in 1/4" increments from 13 1/4" to 30".
 - Reduced Depths available in 1/4" increments from 6" to 12 3/4".
- Recessed Toekick on ends must be specified if required.

Door & Drawer Options

AF	CC	CG	GAMD	IFHG	MD	MFO	PRMD	SGLPN	SHMD	SPLITDR
	✓			✓		✓		✓		✓

End Panel Options

AUTH	CSFPE	EXBK	FFD	FL/FR	FPE	INTGE	IPE
✓	✓	✓	✓	✓	✓	✓	✓

Custom Modification Options

ATTK	CBO	CCO	CFNTO	CFRMO	CLIP	CND	CSDGBK	DRT	DRWTK	EX	EX_OL	FLUT ¹	FTK	ID	IH	IW	LIGHT	MIP	OBRB	
	✓	✓	✓	✓	✓	✓	✓	✓	✓	✓	✓	✓	✓	✓	✓	✓	✓	✓	✓	✓

RD	RECTK	RH	ROSLUT	RT	SRT	TD	TKP	TVR	VTK	WS	WTR
✓	✓	✓	✓	✓	✓	✓	✓	✓	✓	✓	✓

¹ Not available with 6" fluting.

IH/RH availability charts starting on page G-40.
IW/RW availability charts starting on page G-46.

UTILITY, 66", 84", 87", 90", 93", 96", 102", or 108" HIGH, 12" DEEP (cont'd)

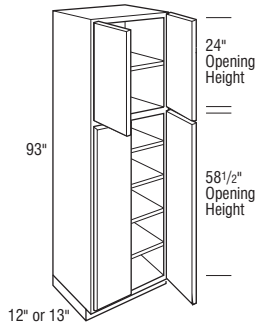
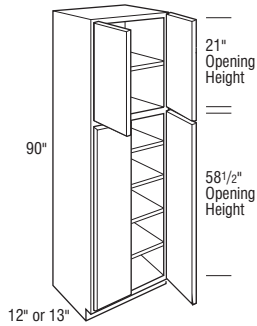
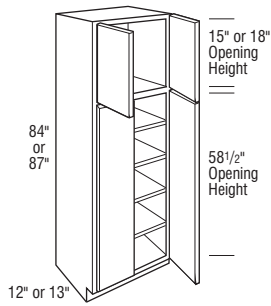

	Cubic Feet	1	2	3	4	5	6	7
U248412	18.3	3292	3452	3550	3742	3997	4372	4747
U278412	20.4	3571	3748	3866	4077	4322	4732	5142
U308412	22.6	3848	4040	4179	4406	4645	5084	5523
U338412	24.8	3965	4159	4307	4544	4793	5237	5681
U368412	26.9	4076	4277	4431	4676	4934	5397	5860
U248712	18.9	3441	3608	3710	3913	4179	4571	4963
U278712	21.2	3741	3925	4051	4274	4536	4958	5380
U308712	23.4	4045	4244	4394	4634	4885	5340	5795
U338712	25.6	4164	4367	4526	4773	5034	5500	5966
U368712	27.8	4282	4493	4651	4908	5179	5662	6145

• Includes four adjustable shelves.

U249012AH	19.6	3586	3764	3870	4080	4366	4769	5172
U279012AH	21.9	3913	4105	4234	4467	4744	5180	5616
U309012AH	24.2	4242	4446	4605	4858	5122	5597	6072
U339012AH	26.5	4366	4575	4740	4999	5276	5762	6248
U369012AH	28.8	4489	4704	4878	5140	5420	5928	6436

• AH represents upper section alignment with doors on 24" or 27" high cabinets.
 • Includes five adjustable shelves.
 • Toekick shipped attached unless otherwise specified.

U249312AH	20.2	3772	3956	4069	4292	4580	5006	5432
U279312AH	22.6	4125	4325	4466	4709	4996	5461	5926
U309312AH	25.0	4479	4698	4864	5134	5410	5912	6414
U339312AH	27.4	4609	4833	5007	5280	5569	6088	6607
U369312AH	29.7	4740	4971	5150	5431	5725	6263	6801

• AH represents upper section alignment with doors on 24" or 27" high cabinets.
 • Includes five adjustable shelves.
 • Shipped with loose toe space unless Attach Toekick or Flush Toekick is specified.

Notes below apply to all products in section above:

- Large opening on tall doors will include two center panels divided by a horizontal rail.
- Inset and Beaded Inset Door Styles are a standard 13" deep.
- Full Overlay Styles:
 - Increased Depths available in 1/4" increments from 12 1/4" to 30".
 - Reduced Depths available in 1/4" increments from 6" to 11 3/4".
- Inset and Beaded Inset Styles:
 - Increased Depths available in 1/4" increments from 13 1/4" to 30".
 - Reduced Depths available in 1/4" increments from 6" to 12 3/4".
- Recessed Toekick on ends must be specified if required.

Door & Drawer Options

AF ¹	CC	CG	GAMD ²	IFHG	MD ²	MFO	PRMD ²	SGLPN	SHMD ²	SPLITDR
✓	✓	✓	✓	✓	✓	✓	✓	✓	✓	✓

End Panel Options

AUTH	CSFPE	EXBK	FFD ³	FL/FR	FPE	INTGE	IPE
✓	✓	✓	✓	✓	✓	✓	✓

Custom Modification Options

ATTK ⁴	CBO	CCO	CFNTO	CFRMO	CLIP ¹	CND	CSDGBK	DRT	DRWTK	EX	EX_OL	FLUT ⁵	FTK	ID	IH	IW ⁶	LIGHT	MIP	OBRB
✓	✓	✓	✓	✓	✓	✓	✓	✓	✓	✓	✓	✓	✓	✓	✓	✓	✓	✓	✓

RD	RECTK ⁷	RH	ROSLUT	RT	SRT	TD ²	TKP ⁸	TVR	VTK	WS	WTR
✓	✓	✓	✓	✓	✓	✓	✓	✓	✓	✓	✓

¹ Not available on 24" wide.
² Only available on top section.
³ Not available on 2484 version.
⁴ Only available on 93" high.
⁵ Not available with 6" fluting.
⁶ Not available on 36" wide.
⁷ Only available on RECTKL.R.BK.
⁸ Not available on 93" high.

Utility Cabinets

UTILITY, 66", 84", 87", 90", 93", 96", 102", or 108" HIGH, 12" DEEP (cont'd)

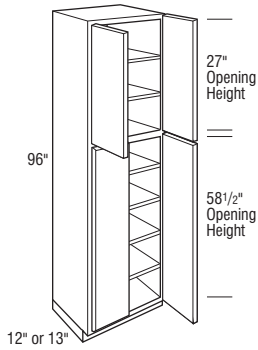

	Cubic Feet	1	2	3	4	5	6	7
U249612	20.9	3956	4146	4264	4498	4796	5241	5686
U279612	23.3	4336	4549	4693	4950	5244	5739	6234
U309612	25.8	4716	4949	5122	5407	5702	6231	6760
U339612	28.2	4856	5094	5276	5560	5864	6414	6964
U369612	30.7	4993	5236	5420	5720	6033	6596	7159

- Includes six adjustable shelves.
- Shipped with loose toe space unless Attach Toekick or Flush Toekick is specified.
- Flush Toekick option not available in conjunction with Wide Top Rail unless loose Flush Toekick is specified.
- Large opening on tall doors will include two center panels divided by a horizontal rail.
- Inset and Beaded Inset Door Styles are a standard 13" deep.
- Full Overlay Styles:
 - Increased Depths available in 1/4" increments from 12 1/4" to 30".
 - Reduced Depths available in 1/4" increments from 6" to 11 3/4".
- Inset and Beaded Inset Styles:
 - Increased Depths available in 1/4" increments from 13 1/4" to 30".
 - Reduced Depths available in 1/4" increments from 6" to 12 3/4".
- Recessed Toekick on ends must be specified if required.

Door & Drawer Options

AF ¹	CC	CG	GAMD ²	IFHG	MD ²	MFO	PRMD ²	SGLPN	SHMD ²	SPLITDR
✓	✓	✓	✓	✓	✓	✓	✓	✓	✓	✓

End Panel Options

AUTH	CSFPE	EXBK	FFD	FL/FR	FPE	INTGE	IPE
✓	✓	✓	✓	✓	✓	✓	✓

Custom Modification Options

ATTK	CBO	CCO	CFNTO	CFRMO ¹	CLIP ¹	CND	CSDGBK	DRT	DRWTK	EX	EX_OL	FLUT ³	FTK	ID	IH	IW ⁴	LIGHT	MIP	OBRB	
✓	✓	✓	✓	✓	✓	✓	✓	✓	✓	✓	✓	✓	✓	✓	✓	✓	✓	✓	✓	✓

RD	RECTK ⁵	RH	ROSLUT	RT	SRT	TD ²	TKP	TVR	VTK	WS	WTR
✓	✓	✓	✓	✓	✓	✓	✓	✓	✓	✓	✓

- ¹ Not available on 24" wide.
² Only available on top section.
³ Not available with 6" fluting.
⁴ Not available on 36" wide.
⁵ Only available on RECTKL.R.BK.

IH/RH availability charts starting on page G•40.
 IW/RW availability charts starting on page G•46.

UTILITY, 66", 84", 87", 90", 93", 96", 102", or 108" HIGH, 12" DEEP (cont'd)

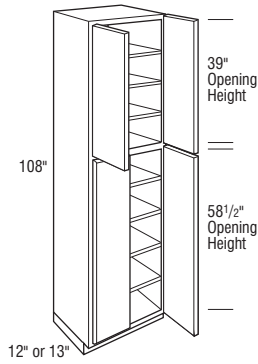
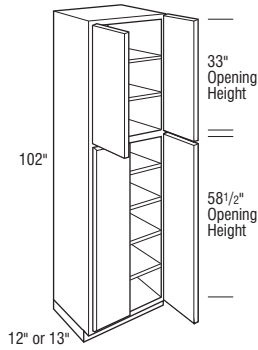

	Cubic Feet	1	2	3	4	5	6	7
U2410212	33.8	6864	7128	7291	7616	8029	8647	9265
U2710212	37.1	7391	7687	7887	8243	8651	9338	10025
U3010212	40.5	7918	8242	8482	8877	9287	10021	10755
U3310212	43.9	8113	8443	8695	9090	9511	10274	11037
U3610212	47.3	8303	8640	8895	9312	9746	10527	11308

- Includes six adjustable shelves.

U2410812	35.6	7619	7912	8093	8454	8913	9598	10283
U2710812	39.2	8204	8532	8754	9150	9603	10365	11127
U3010812	42.8	8789	9148	9415	9854	10308	11123	11938
U3310812	46.3	9005	9372	9652	10089	10558	11405	12252
U3610812	46.9	9216	9590	9874	10336	10818	11685	12552

- Includes seven adjustable shelves.

Notes below apply to all products in section above:

- Shipped with loose toe space unless Attach Toekick or Flush Toekick is specified.
- Large opening on tall doors will include two center panels divided by a horizontal rail.
- Inset and Beaded Inset Door Styles are a standard 13" deep.
- Full Overlay Styles:
 - Increased Depths available in 1/4" increments from 12 1/4" to 26".
 - Reduced Depths available in 1/4" increments from 6" to 11 3/4".
- Inset and Beaded Inset Styles:
 - Increased Depths available in 1/4" increments from 13 1/4" to 26".
 - Reduced Depths available in 1/4" increments from 6" to 12 3/4".
- Recessed Toekick on ends must be specified if required.
- Finish Flushed Ends standard.

Door & Drawer Options

AF ¹	CC	CG	GAMD ³	IFHG	MD ²	WFO	PRMD ²	SGLPN	SHMD ²	SPLITDR
✓	✓	✓	✓	✓	✓	✓	✓	✓	✓	✓

End Panel Options

AUTH	CSFPE	EXBK ³	FFD	FL/ER	FPE	INTGE	IPE
✓	✓	✓	✓	✓	✓	✓	✓

Custom Modification Options

ATTK ¹	CBO	CCO	CFNTO	CFRMO	CLIP	CND	CSDGBK	DRT	DRWTK ⁴	EX	EX_OL	FLUT ⁵	FTK	ID	IH ⁶	IW ⁷	LIGHT	MIP	OBRB	
✓	✓	✓	✓	✓	✓	✓	✓	✓	✓	✓	✓	✓	✓	✓	✓	✓	✓	✓	✓	✓

RD	RECTK	RH ⁶	ROSFLUT ⁵	RT	SRT	TD ²	TKP	TVR	VTK	WS	WTR
✓	✓	✓	✓	✓	✓	✓	✓	✓	✓	✓	✓

¹ Not available on 24" wide.

² Only available on top section.

³ This modification will allow the end to extend back to a maximum of 30" deep.

⁴ Only available when used in conjunction with attach toekick modification.

⁵ Not available with 6" fluting.

⁶ Not available on 108" high.

⁷ Not available on 36" wide.

Utility Cabinets

NEW UTILITY, 66", 84", 87", 90", 93", 96", 102", or 108" HIGH, 24" DEEP

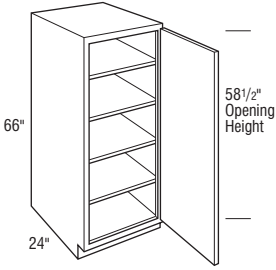

	Cubic Feet	1	2	3	4	5	6	7
U126624 L or R	14.0	1984	2086	2159	2278	2403	2631	2859
U156624 L or R	17.0	2119	2222	2305	2429	2569	2808	3047
U186624 L or R	20.1	2248	2357	2442	2579	2725	2980	3235
U216624 L or R	23.1	2358	2474	2565	2706	2857	3122	3387
U246624 L or R	26.2	2472	2590	2686	2830	2994	3274	3554

- Includes four adjustable shelves.
- Doors will include two center panels divided by a horizontal rail.
- Increased Depths available in 1/4" increments from 24 1/4" to 30".
- Reduced Depths available in 1/4" increments from 6" to 23 3/4".

Door & Drawer Options

AF	CC	CG	GAMD	IFHG	MD	MFO	PRMD	SGLPN	SHMD	SPLITDR
		✓		✓		✓		✓		

End Panel Options

AUTH	CSFPE	EXBK	FFD	FL/FR	FPE	INTGE	IPE
✓	✓	✓	✓	✓	✓	✓	✓

Custom Modification Options

ATTK	CBO	CCO	CFNTO	CFRMO	CLIP	CND	CSDGBK	DRT	DRWTK	EX	EX_OL	FLUT ¹	FTK	ID	IH	IW	LIGHT	MIP	OBRB
	✓	✓	✓	✓	✓	✓	✓		✓	✓	✓	✓	✓	✓	✓			✓	✓

RD	RECTK	RH	ROSEFLUT ¹	RT	SRT	TD	TKP	TVR ²	VTK	WS ³	WTR
✓	✓		✓	✓			✓	✓	✓	✓	✓

¹ 12" wide not available with fluting both. Not available with 6" fluting.

² 12" wide not available except with TVRVV.

³ Wide stile both 3" not available on 12" wide.

IH/RH availability charts starting on page G•40.
IW/RW availability charts starting on page G•46.

UTILITY, 66", 84", 87", 90", 93", 96", 102", or 108" HIGH, 24" DEEP (cont'd)

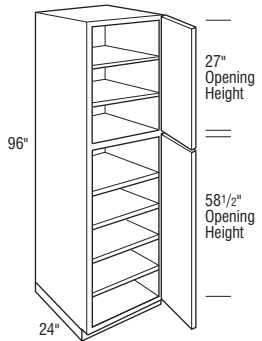
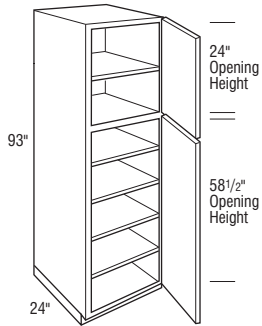
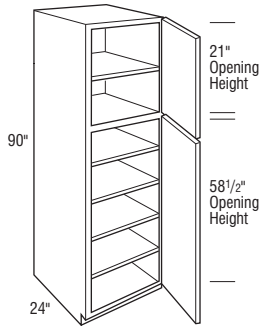
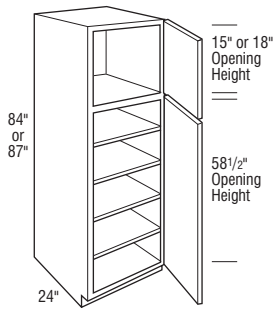

	Cubic Feet	1	2	3	4	5	6	7
U128424 L or R	17.7	2281	2394	2480	2618	2764	3026	3288
U158424 L or R	21.6	2404	2519	2615	2756	2911	3182	3453
U188424 L or R	25.6	2558	2679	2781	2935	3093	3385	3677
U218424 L or R	29.5	2717	2850	2948	3112	3286	3591	3896
U248424 L or R	33.4	2869	3009	3122	3291	3485	3804	4123
U128724 L or R	18.3	2382	2501	2590	2732	2886	3157	3428
U158724 L or R	22.4	2524	2650	2747	2896	3062	3346	3630
U188724 L or R	26.5	2687	2815	2914	3079	3250	3558	3866
U218724 L or R	30.5	2834	2971	3079	3244	3427	3748	4069
U248724 L or R	34.6	2981	3126	3238	3416	3617	3951	4285

• Includes four adjustable shelves.

U129024AH L or R	18.9	2480	2607	2699	2847	3004	3289	3574
U159024AH L or R	23.2	2649	2777	2881	3036	3211	3510	3809
U189024AH L or R	27.4	2810	2946	3052	3224	3406	3725	4044
U219024AH L or R	31.6	2948	3093	3206	3382	3571	3902	4233
U249024AH L or R	35.8	3090	3238	3357	3537	3742	4093	4444

• AH represents upper section alignment with doors on 24" or 27" high cabinets.
 • Includes five adjustable shelves.
 • Toekick shipped attached unless otherwise specified.

U129324AH L or R	19.6	2620	2752	2852	3005	3176	3469	3762
U159324AH L or R	23.9	2796	2934	3041	3207	3384	3703	4022
U189324AH L or R	28.3	2967	3114	3224	3399	3590	3928	4266
U219324AH L or R	32.6	3093	3243	3361	3547	3746	4093	4440
U249324AH L or R	37.0	3224	3379	3497	3691	3905	4271	4637

• AH represents upper section alignment with doors on 24" or 27" high cabinets.
 • Includes five adjustable shelves.
 • Shipped with loose toe space unless Attach Toekick or Flush Toekick is specified.

U129624 L or R	20.2	2762	2901	2999	3171	3340	3650	3960
U159624 L or R	24.7	2946	3090	3203	3379	3560	3895	4230
U189624 L or R	29.2	3121	3276	3392	3581	3775	4130	4485
U219624 L or R	33.6	3235	3392	3515	3709	3921	4286	4651
U249624 L or R	38.1	3355	3516	3639	3838	4069	4446	4823

• Includes six adjustable shelves.
 • Shipped with loose toe space unless Attach Toekick or Flush Toekick is specified.
 • Flush Toekick option not available in conjunction with Wide Top Rail unless loose Flush Toekick is specified.

Notes below apply to all products in section above:

- Large opening on tall doors will include two center panels divided by a horizontal rail.
- Increased Depths available in 1/4" increments from 24 1/4" to 30".
- Reduced Depths available in 1/4" increments from 6" to 23 3/4".

Door & Drawer Options

AF	CC	CG	GAMD ¹	IFHG	MD ¹	MFO	PRMD ²	SGLPN	SHMD ¹	SPLITDR
✓	✓	✓	✓	✓	✓	✓	✓	✓	✓	✓

End Panel Options

AUTH	CSFPE	EXBK	FFD ³	FL/FR	FPE	INTGE	IPE
✓	✓	✓	✓	✓	✓	✓	✓

Custom Modification Options

ATTK ⁴	CBO ⁵	CCO	CFNT0	CFRMO	CLIP ⁶	CND	CSDGBK	DRT	DRWTK	EX	EX_OL	FLUT ⁷	FTK ⁸	ID	IH ⁹	IW ¹⁰	LIGHT	MIP	OBRB	
✓	✓	✓	✓	✓	✓	✓	✓	✓	✓	✓	✓	✓	✓	✓	✓	✓	✓	✓	✓	✓

RD	RECTK ¹¹	RH	ROSFLUT	RT	SRT	TD ¹	TKP ¹²	TVR ¹³	VTK	WS	WTR
✓	✓	✓	✓	✓	✓	✓	✓	✓	✓	✓	✓

¹ Only available on top section.
² Not available on 12" wide. Only available on top section.
³ Not available on 1284 version.
⁴ Only available on 93"-96" high.
⁵ Not available on 12" wide or on 1584 version.
⁶ Not available on 12" wide.
⁷ Not available with 6" fluting.
⁸ FTKAV and style B-L not available on 12" wide.
⁹ Not available on 96" high.
¹⁰ Not available on 24" wide.
¹¹ Only available on RECTKL.R.BK.
¹² Not available on 93"-96" high.
¹³ Not available on 12" wide.

Utility Cabinets

UTILITY, 66", 84", 87", 90", 93", 96", 102", or 108" HIGH, 24" DEEP (cont'd)

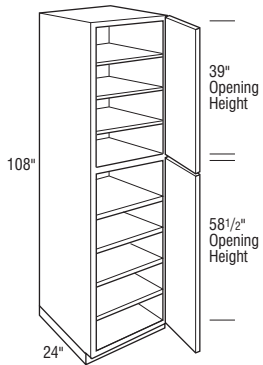
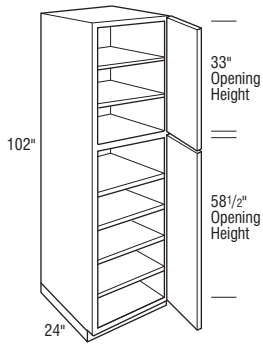

	Cubic Feet	1	2	3	4	5	6	7
U1210224 L or R	33.8	5207	5400	5536	5775	6009	6439	6869
U1510224 L or R	39.4	5463	5662	5819	6063	6315	6779	7243
U1810224 L or R	45.0	5705	5920	6081	6344	6613	7105	7597
U2110224 L or R	50.6	5864	6081	6252	6521	6815	7322	7829
U2410224 L or R	56.3	6030	6253	6424	6700	7021	7544	8067

• Includes six adjustable shelves.

U1210824 L or R	35.6	5780	5994	6145	6410	6670	7148	7626
U1510824 L or R	41.6	6063	6285	6459	6730	7009	7525	8041
U1810824 L or R	47.5	6333	6572	6750	7041	7340	7887	8434
U2110824 L or R	53.4	6509	6750	6940	7239	7565	8127	8689
U2410824 L or R	59.4	6693	6941	7131	7437	7793	8374	8955

• Includes seven adjustable shelves.

Notes below apply to all products in section above:

- Shipped with loose toe space unless Attach Toekick or Flush Toekick is specified.
- Large opening on tall doors will include two center panels divided by a horizontal rail.
- Increased Depths available in 1/4" increments from 24 1/4" to 26".
- Reduced Depths available in 1/4" increments from 6" to 23 3/4".
- Finish Flushed Ends standard.

Door & Drawer Options

AF	CC	CG	GAMD ¹	IFHG	MD ¹	MFO	PRMD ²	SGLPN	SHMD ¹	SPLITDR
✓	✓	✓	✓	✓	✓	✓	✓	✓	✓	✓

End Panel Options

AUTH	CSFPE	EXBK ³	FFD	FL/FR	FPE	INTGE	IPE
✓	✓	✓	✓	✓	✓	✓	✓

Custom Modification Options

ATTK	CBO	CCO	CFNTO	CFRMO	CLIP	CND	CSDGBK	DRT	DRWTK ⁴	EX	EX_OL	FLUT ⁵	FTK ⁶	ID	IH ⁷	IW ⁸	LIGHT	MIP	OBRB	
✓	✓	✓	✓	✓	✓	✓	✓	✓	✓	✓	✓	✓	✓	✓	✓	✓	✓	✓	✓	✓

RD	RECTK	RH ⁹	ROSLUT ⁵	RT	SRT	TD ¹	TKP	TVR ⁹	VTK	WS	WTR
✓	✓	✓	✓	✓	✓	✓	✓	✓	✓	✓	✓

¹ Only available on top section.

² Not available on 12" wide. Only available on top section.

³ This modification will allow the end to extend back to a maximum of 30" deep.

⁴ Only available when used in conjunction with attach toekick modification.

⁵ Not available with 6" fluting.

⁶ FTKAV and style B-L not available on 12" wide.

⁷ Not available on 108" high.

⁸ Not available on 24" wide.

⁹ Not available on 12" wide.

IH/RH availability charts starting on page G-40.
IW/RW availability charts starting on page G-46.

NEW UTILITY, 66", 84", 87", 90", 93", 96", 102", or 108" HIGH, 24" DEEP (cont'd)

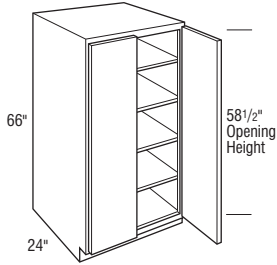

	Cubic Feet	1	2	3	4	5	6	7
U246624	26.2	3137	3289	3383	3569	3806	4160	4514
U276624	29.2	3498	3667	3792	3999	4242	4638	5034
U306624	32.2	3864	4052	4194	4433	4678	5113	5548
U336624	35.3	3988	4182	4332	4572	4826	5275	5724
U366624	38.3	4112	4310	4464	4712	4973	5438	5903

- Includes four adjustable shelves.
- Doors will include two center panels divided by a horizontal rail.
- Increased Depths available in 1/4" increments from 24 1/4" to 30".
- Reduced Depths available in 1/4" increments from 6" to 23 3/4".

Door & Drawer Options

AF	CC	CG	GAMD	IFHG	MD	MFO	PRMD	SGLPN	SHMD	SPLITDR
	✓			✓		✓		✓		✓

End Panel Options

AUTH	CSFPE	EXBK	FFD	FL/FR	FPE	INTGE	IPE
✓	✓	✓	✓	✓	✓	✓	✓

Custom Modification Options

ATTK	CBO	CCO	CFNT	CFRMO	CLIP	CND	CSDGBK	DRT	DRWTK	EX	EX_OL	FLUT ¹	FTK	ID	IH	IW	LIGHT	MIP	OBRB
	✓	✓	✓	✓	✓	✓	✓		✓	✓	✓	✓	✓	✓				✓	✓

RD	RECTK	RH	ROSLUT ¹	RT	SRT	TD	TKP	TVR	VTK	WS	WTR
✓	✓		✓	✓			✓	✓	✓	✓	✓

¹ Not available with 6" fluting.

Utility Cabinets

UTILITY, 66", 84", 87", 90", 93", 96", 102", or 108" HIGH, 24" DEEP (cont'd)

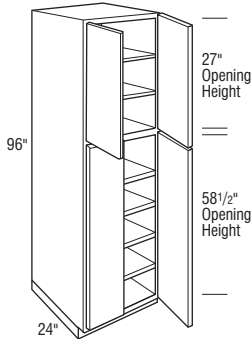
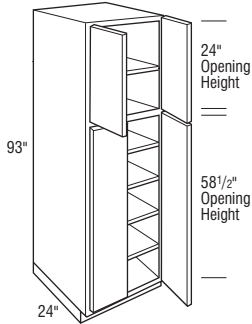
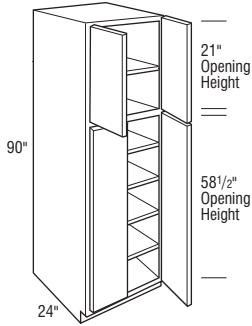
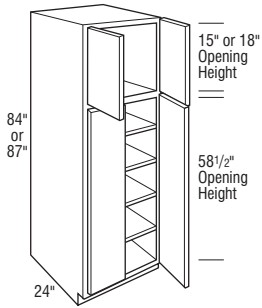

	Cubic Feet	1	2	3	4	5	6	7
U248424	33.4	3657	3837	4084	4296	4447	4863	5279
U278424	37.4	4025	4223	4429	4669	4884	5335	5786
U308424	41.3	4390	4606	4769	5035	5311	5809	6307
U338424	45.2	4533	4750	4924	5196	5490	6003	6516
U368424	49.2	4673	4897	5074	5360	5664	6194	6724
U248724	34.6	3789	3975	4159	4381	4605	5031	5457
U278724	38.7	4201	4404	4582	4832	5094	5565	6036
U308724	42.8	4609	4833	5007	5286	5579	6099	6619
U338724	46.8	4758	4991	5167	5455	5760	6300	6840
U368724	50.9	4906	5142	5330	5624	5941	6495	7049

• Includes four adjustable shelves.

U249024AH	35.8	3921	4111	4229	4461	4758	5200	5642
U279024AH	40.0	4373	4584	4740	4999	5303	5797	6291
U309024AH	44.2	4830	5065	5243	5541	5847	6391	6935
U339024AH	48.4	4985	5227	5415	5715	6033	6594	7155
U369024AH	52.6	5140	5387	5580	5890	6216	6798	7380

• AH represents upper section alignment with doors on 24" or 27" high cabinets.

• Includes five adjustable shelves.

• Toekick shipped attached unless otherwise specified.

U249324AH	37.0	4087	4290	4416	4654	4970	5430	5890
U279324AH	41.3	4592	4817	4977	5248	5569	6086	6603
U309324AH	45.7	5098	5344	5537	5845	6169	6740	7311
U339324AH	50.0	5259	5515	5714	6032	6360	6953	7546
U369324AH	54.3	5420	5685	5888	6215	6556	7165	7774

• AH represents upper section alignment with doors on 24" or 27" high cabinets.

• Includes five adjustable shelves.

• Shipped with loose toe space unless Attach Toekick or Flush Toekick is specified.

U249624	38.1	4254	4464	4601	4848	5177	5661	6145
U279624	42.6	4809	5045	5213	5499	5835	6378	6921
U309624	47.1	5367	5624	5822	6146	6488	7085	7682
U339624	51.6	5535	5804	6008	6342	6687	7311	7935
U369624	56.1	5702	5982	6194	6537	6893	7534	8175

• Includes six adjustable shelves.

• Shipped with loose toe space unless Attach Toekick or Flush Toekick is specified.

• Flush Toekick option not available in conjunction with Wide Top Rail unless loose Flush Toekick is specified.

Notes below apply to all products in section above:

- Large opening on tall doors will include two center panels divided by a horizontal rail.
- Increased Depths available in 1/4" increments from 24 1/4" to 30".
- Reduced Depths available in 1/4" increments from 6" to 23 3/4".

Door & Drawer Options

AF	CC	CG	GAMD ¹	IFHG	MD ¹	MFO	PRMD ¹	SGLPN	SHMD ¹	SPLITDR
✓	✓	✓	✓	✓	✓	✓	✓	✓	✓	✓

End Panel Options

AUTH	CSFPE	EXBK	FFD	FL/FR	FPE	INTGE	IPE
✓	✓	✓	✓	✓	✓	✓	✓

Custom Modification Options

ATTK ²	CBO ³	CCO	CFNT0	CFRMO ⁴	CLIP ⁵	CND	CSDGBK	DRT	DRWTK	EX	EX_OL	FLUT ⁶	FTK	ID	IH ⁷	IW ⁸	LIGHT	MP	OBRB	
✓	✓	✓	✓	✓	✓	✓	✓	✓	✓	✓	✓	✓	✓	✓	✓	✓	✓	✓	✓	✓

RD	RECTK ⁹	RH	ROSFLUT	RT	SRT	TD ¹⁰	TKP ¹⁰	TVR	VTK	WS	WTR
✓	✓	✓	✓	✓	✓	✓	✓	✓	✓	✓	✓

¹ Only available on top section.

² Only available on 93"-96" high.

³ Only available on 24" wide.

⁴ Not available on 2496 version.

⁵ Not available on 24" wide.

⁶ Not available with 6" fluting.

⁷ Not available on 96" high.

⁸ Not available on 36" wide.

⁹ Only available on RECTLR.BK.

¹⁰ Not available on 93"-96" high.

IH/RH availability charts starting on page G-40.
IW/RW availability charts starting on page G-46.

UTILITY, 66", 84", 87", 90", 93", 96", 102", or 108" HIGH, 24" DEEP (cont'd)

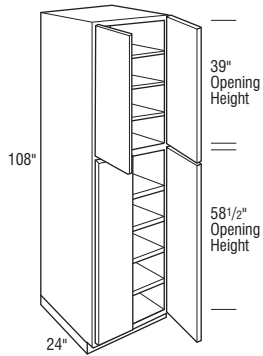
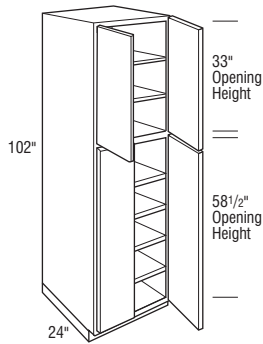

	Cubic Feet	1	2	3	4	5	6	7
U2410224	56.3	7277	7569	7759	8102	8558	9230	9902
U2710224	61.9	8047	8375	8608	9005	9471	10224	10977
U3010224	67.5	8822	9178	9453	9903	10377	11205	12033
U3310224	73.1	9055	9428	9711	10175	10653	11519	12385
U3610224	78.8	9287	9675	9969	10445	10939	11828	12717

• Includes six adjustable shelves.

U2410824	59.4	8078	8401	8612	8993	9499	10245	10991
U2710824	65.3	8933	9296	9555	9995	10513	11349	12185
U3010824	71.3	9792	10188	10493	10992	11519	12438	13357
U3310824	77.2	10051	10465	10779	11294	11825	12786	13747
U3610824	83.1	10308	10739	11066	11594	12142	13130	14118

• Includes seven adjustable shelves.

Notes below apply to all products in section above:

- Shipped with loose toe space unless Attach Toekick or Flush Toekick is specified.
- Large opening on tall doors will include two center panels divided by a horizontal rail.
- Increased Depths available in 1/4" increments from 24 1/4" to 26".
- Reduced Depths available in 1/4" increments from 6" to 23 3/4".
- Finish Flushed Ends standard.

Door & Drawer Options

AF	CC	CG	GAMD ¹	IFHG	MD ¹	MFO	PRMD ¹	SGLPN	SHMD ¹	SPLITDR
✓	✓	✓	✓	✓	✓	✓	✓	✓	✓	✓

End Panel Options

AUTH	CSFPE	EXBK ²	FFD	FL/FR	FPE	INTGE	IPE
✓	✓	✓	✓	✓	✓	✓	✓

Custom Modification Options

ATTK	CBO	CCO	CFNT0	CFRMO	CLIP	CND	CSDGBK	DRT	DRWTK ³	EX	EX_OL	FLUT ⁴	FTK	ID	IH ⁵	IW ⁶	LIGHT	MIP	OBRB
✓	✓	✓	✓	✓	✓	✓	✓	✓	✓	✓	✓	✓	✓	✓	✓	✓	✓	✓	✓

RD	RECTK	RH ⁵	ROSFLUT ⁴	RT	SRT	TD ¹	TKP	TVR	VTK	WS	WTR
✓	✓	✓	✓	✓	✓	✓	✓	✓	✓	✓	✓

¹ Only available on top section.

² This modification will allow the end to extend back to a maximum of 30" deep.

³ Only available when used in conjunction with attach toekick modification.

⁴ Not available with 6" fluting.

⁵ Not available on 108" high.

⁶ Not available on 36" wide.

Utility Drawer Cabinets

UTILITY with THREE DRAWERS, 84", 87", 90", 93", or 96" HIGH, 24" DEEP

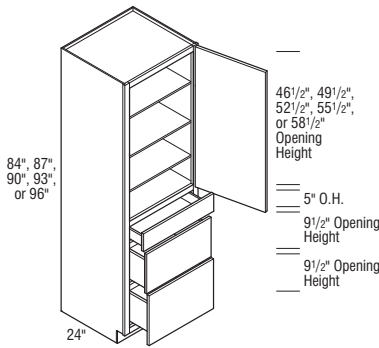

	Cubic Feet	1	2	3	4	5	6	7
U3D128424 L or R	17.7	3308	3473	3596	3795	4007	4388	4769
U3D158424 L or R	21.6	3485	3652	3791	3994	4221	4616	5011
U3D188424 L or R	25.6	3709	3885	4034	4256	4485	4908	5331
U3D218424 L or R	29.5	3940	4132	4275	4512	4764	5207	5650
U3D248424 L or R	33.4	4159	4363	4527	4773	5054	5516	5978
U3D128724 L or R	18.3	3453	3625	3754	3962	4185	4576	4967
U3D158724 L or R	22.4	3661	3841	3985	4200	4440	4852	5264
U3D188724 L or R	26.5	3896	4080	4226	4466	4713	5157	5601
U3D218724 L or R	30.5	4111	4307	4466	4704	4970	5436	5902
U3D248724 L or R	34.6	4323	4533	4696	4953	5244	5730	6216
U3D129024 L or R	18.9	3596	3779	3913	4128	4355	4771	5187
U3D159024 L or R	23.2	3839	4026	4178	4403	4655	5088	5521
U3D189024 L or R	27.4	4074	4274	4425	4676	4938	5400	5862
U3D219024 L or R	31.6	4275	4485	4648	4903	5178	5659	6140
U3D249024 L or R	35.8	4482	4696	4868	5129	5428	5936	6444

• Includes three adjustable shelves in upper section.

U3D129324 L or R	19.6	3799	3989	4133	4356	4606	5030	5454
U3D159324 L or R	23.9	4055	4254	4409	4649	4907	5370	5833
U3D189324 L or R	28.3	4302	4515	4676	4929	5205	5696	6187
U3D219324 L or R	32.6	4485	4702	4873	5143	5432	5936	6440
U3D249324 L or R	37.0	4676	4900	5072	5351	5662	6193	6724

• Includes four adjustable shelves in upper section.

• Shipped with loose toe space unless Attach Toekick or Flush Toekick is specified.

U3D129624 L or R	20.2	4004	4205	4350	4598	4843	5293	5743
U3D159624 L or R	24.7	4274	4482	4644	4900	5161	5648	6135
U3D189624 L or R	29.2	4526	4750	4919	5193	5474	5988	6502
U3D219624 L or R	33.6	4692	4919	5095	5377	5685	6215	6745
U3D249624 L or R	38.1	4863	5098	5277	5565	5900	6447	6994

• Includes four adjustable shelves in upper section.

• Shipped with loose toe space unless Attach Toekick or Flush Toekick is specified.

• Flush Toekick option not available in conjunction with Wide Top Rail unless loose Flush Toekick is specified.

Notes below apply to all products in section above:

- Large opening on tall doors will include two center panels divided by a horizontal rail.
- Drawers are the same size as on a standard 34 1/2" high three drawer base.
- Reduced Depths available in 1/4" increments from 12" to 23 3/4".

Door & Drawer Options

AF	CC	CG	GAMD	IFHG	MD	MFO	PRMD	SGLPN ¹	SHMD	SPLITDR
✓	✓			✓		✓		✓		

End Panel Options

AUTH	CSFPE	EXBK	FFD	FL/FR	FPE	INTGE	IPE
✓	✓	✓	✓	✓	✓	✓	✓

Custom Modification Options

ATTK ²	CBO	CCO	CFNT0	CFRMO	CLIP ³	CND	CSDGBK	DRT	DRWTK	EX	EX_OL	FLUT	FTK ⁴	ID	IH ⁵	IW ⁶	LIGHT	MIP	OBRB	
✓	✓	✓	✓	✓	✓	✓	✓	✓	✓	✓	✓	✓	✓	✓	✓	✓	✓	✓	✓	✓

RD	RECTK	RH	ROSLUT	RT	SRT	TD	TKP ⁷	TVR ⁸	VTK	WS	WTR
✓	✓	✓	✓	✓	✓	✓	✓	✓	✓	✓	✓

¹ Only available on 96" high.

² Only available on 93" or 96" high.

³ Not available on 12" wide.

⁴ FTAV and style B-L not available on 12" wide.

⁵ Not available on 96" high.

⁶ Not available on 24" wide.

⁷ Not available on 93" or 96" high.

⁸ TVRAV and style B-L not available on 12" wide.

IH/RH availability charts starting on page G•40.
IW/RW availability charts starting on page G•46.

Utility Drawer Cabinets

UTILITY with THREE DRAWERS, 84", 87", 90", 93", or 96" HIGH, 24" DEEP

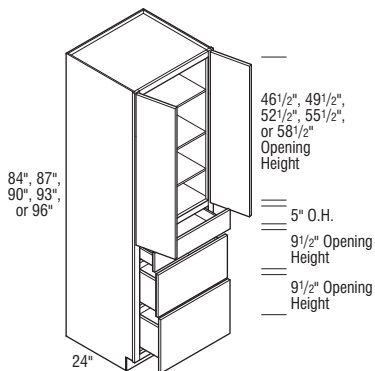

	Cubic Feet	1	2	3	4	5	6	7
U3D248424	33.4	5302	5563	5922	6230	6449	7053	7657
U3D278424	37.4	5836	6123	6420	6768	7081	7735	8389
U3D308424	41.3	6366	6679	6915	7301	7701	8423	9145
U3D338424	45.2	6573	6888	7140	7534	7960	8705	9450
U3D368424	49.2	6776	7102	7358	7772	8213	8980	9747
U3D248724	34.6	5494	5762	6033	6351	6676	7296	7916
U3D278724	38.7	6092	6387	6644	7006	7386	8070	8754
U3D308724	42.8	6685	7008	7260	7664	8088	8844	9600
U3D338724	46.8	6900	7236	7493	7910	8353	9134	9915
U3D368724	50.9	7114	7456	7728	8155	8614	9418	10222
U3D249024	35.8	5685	5960	6132	6468	6900	7541	8182
U3D279024	40.0	6342	6647	6873	7249	7690	8406	9122
U3D309024	44.2	7003	7345	7602	8033	8478	9267	10056
U3D339024	48.4	7227	7578	7853	8288	8747	9561	10375
U3D369024	42.6	7452	7810	8090	8540	9015	9856	10697

• Includes three adjustable shelves in upper section.

U3D249324	37.0	5925	6220	6403	6749	7205	7873	8541
U3D279324	41.3	6659	6984	7216	7610	8076	8824	9572
U3D309324	45.7	7392	7749	8028	8475	8946	9773	10600
U3D339324	50.0	7626	7997	8285	8744	9223	10081	10939
U3D369324	54.3	7861	8242	8536	9012	9506	10389	11272

• Includes four adjustable shelves in upper section.

• Shipped with loose toe space unless Attach Toekick or Flush Toekick is specified.

U3D249624	38.1	6168	6472	6671	7029	7505	8210	8915
U3D279624	42.6	6973	7315	7561	7973	8460	9250	10040
U3D309624	47.1	7783	8155	8443	8911	9407	10274	11141
U3D339624	51.6	8024	8416	8712	9194	9695	10600	11505
U3D369624	56.1	8268	8674	8980	9479	9994	10925	11856

• Includes four adjustable shelves in upper section.

• Shipped with loose toe space unless Attach Toekick or Flush Toekick is specified.

• Flush Toekick option not available in conjunction with Wide Top Rail unless loose Flush Toekick is specified.

Notes below apply to all products in section above:

- Large opening on tall doors will include two center panels divided by a horizontal rail.
- Drawers are the same size as on a standard 34 1/2" high three drawer base.
- Reduced Depths available in 1/4" increments from 12" to 23 3/4".

Door & Drawer Options

AF	CC	CG	GAMD	IFHG	MD	MFO	PRMD	SGLPN ¹	SHMD	SPLTDR
✓	✓	✓	✓	✓	✓	✓	✓	✓	✓	✓

End Panel Options

AUTH	CSFPE	EXBK	FFD	FL/FR	FPE	INTGE	IPE
✓	✓	✓	✓	✓	✓	✓	✓

Custom Modification Options

ATTK ²	CBO	CCO	CFNT0	CFRMO	CLIP	CND	CSDGBK	DRT	DRWTK	EX	EX_OL	FLUT	FTK	ID	IH ³	IW ⁴	LIGHT	MIP	OBRB	
✓	✓	✓	✓	✓	✓	✓	✓	✓	✓	✓	✓	✓	✓	✓	✓	✓	✓	✓	✓	✓

RD	RECTK	RH	ROSFLUT	RT	SRT	TD	TKP ⁵	TVR	VTK	WS ⁶	WTR
✓	✓	✓	✓	✓	✓	✓	✓	✓	✓	✓	✓

¹ Only available on 96" high.

² Only available on 93" or 96" high.

³ Not available on 96" high.

⁴ Not available on 36" wide.

⁵ Not available on 93"-96" high.

⁶ Not available on 24" wide.

Utility Drawer Cabinets

UTILITY with FOUR DRAWERS, 84", 87", 90", 93", or 96" HIGH, 24" DEEP

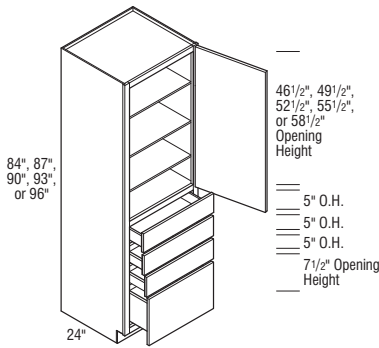

	Cubic Feet	1	2	3	4	5	6	7
U4D128424 L or R	17.7	3536	3711	3844	4057	4285	4691	5097
U4D158424 L or R	21.6	3725	3905	4053	4271	4510	4933	5356
U4D188424 L or R	25.6	3964	4153	4311	4549	4794	5248	5702
U4D218424 L or R	29.5	4212	4418	4570	4824	5093	5565	6037
U4D248424 L or R	33.4	4446	4662	4840	5102	5402	5896	6390
U4D128724 L or R	18.3	3692	3876	4015	4235	4474	4892	5310
U4D158724 L or R	22.4	3913	4106	4258	4489	4745	5188	5631
U4D188724 L or R	26.5	4165	4363	4517	4773	5039	5514	5989
U4D218724 L or R	30.5	4393	4605	4773	5029	5312	5810	6308
U4D248724 L or R	34.6	4621	4844	5019	5295	5605	6125	6645
U4D129024 L or R	18.9	3844	4040	4183	4414	4655	5099	5543
U4D159024 L or R	23.2	4104	4303	4467	4705	4976	5440	5904
U4D189024 L or R	27.4	4354	4568	4730	4997	5280	5773	6266
U4D219024 L or R	31.6	4570	4794	4969	5242	5536	6049	6562
U4D249024 L or R	35.8	4790	5019	5202	5483	5800	6344	6888

• Includes three adjustable shelves in upper section.

U4D129324 L or R	19.6	4062	4265	4420	4657	4923	5377	5831
U4D159324 L or R	23.9	4335	4548	4714	4971	5245	5740	6235
U4D189324 L or R	28.3	4598	4826	4997	5269	5564	6088	6612
U4D219324 L or R	32.6	4794	5028	5209	5498	5806	6344	6882
U4D249324 L or R	37.0	4997	5238	5423	5720	6052	6620	7188

• Includes four adjustable shelves in upper section.

• Shipped with loose toe space unless Attach Toekick or Flush Toekick is specified.

U4D129624 L or R	20.2	4281	4495	4649	4915	5178	5658	6138
U4D159624 L or R	24.7	4568	4790	4964	5238	5517	6038	6559
U4D189624 L or R	29.2	4837	5078	5258	5551	5852	6401	6950
U4D219624 L or R	33.6	5014	5258	5447	5749	6076	6643	7210
U4D249624 L or R	38.1	5199	5448	5640	5949	6307	6891	7475

• Includes four adjustable shelves in upper section.

• Shipped with loose toe space unless Attach Toekick or Flush Toekick is specified.

• Flush Toekick option not available in conjunction with Wide Top Rail unless loose Flush Toekick is specified.

Notes below apply to all products in section above:

- Large opening on tall doors will include two center panels divided by a horizontal rail.
- Drawers are the same size as on a standard 34 1/2" high four drawer base.
- Reduced Depths available in 1/4" increments from 12" to 23 3/4".

Door & Drawer Options

AF	CC	CG	GAMD	IFHG	MD	MFO	PRMD	SGLPN ¹	SHMD	SPLITDR
✓	✓			✓		✓		✓		

End Panel Options

AUTH	CSFPE	EXBK	FFD	FL/FR	FPE	INTGE	IPE
✓	✓	✓	✓	✓	✓	✓	✓

Custom Modification Options

ATTK ²	CBO	CCO	CFNT0	CFRMO	CLIP ³	CND	CSDGBK	DRT	DRWTK	EX	EX_OL	FLUT	FTK ⁴	ID	IH ⁵	IW ⁶	LIGHT	MIP	OBRB
✓	✓	✓	✓	✓	✓	✓	✓	✓	✓	✓	✓	✓	✓	✓	✓	✓	✓	✓	✓

RD	RECTK	RH	ROSLUT	RT	SRT	TD	TKP ⁷	TVR ⁸	VTK	WS ⁹	WTR
✓	✓	✓	✓	✓	✓	✓	✓	✓	✓	✓	✓

¹ Only available on 96" high.

² Only available on 93" or 96" high.

³ Not available on 12" wide.

⁴ FTAV and style B-L not available on 12" wide.

⁵ Not available on 96" high.

⁶ Not available on 24" wide.

⁷ Not available on 93"-96" high.

⁸ TVRAV and style B-L not available on 12" wide.

⁹ Wide stile both 3" not available on 12" wide.

IH/RH availability charts starting on page G•40.
IW/RW availability charts starting on page G•46.

Utility Drawer Cabinets

UTILITY with FOUR DRAWERS, 84", 87", 90", 93", or 96" HIGH, 24" DEEP

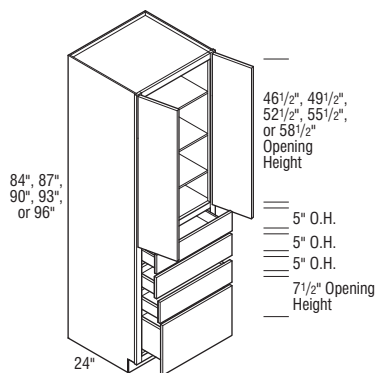

	Cubic Feet	1	2	3	4	5	6	7
U4D248424	33.4	5667	5948	6330	6659	6894	7537	8180
U4D278424	37.4	6239	6546	6864	7235	7569	8269	8969
U4D308424	41.3	6805	7140	7392	7804	8232	9005	9778
U4D338424	45.2	7026	7363	7632	8055	8510	9306	10102
U4D368424	49.2	7243	7591	7865	8309	8780	9600	10420
U4D248724	34.6	5873	6161	6447	6791	7139	7799	8459
U4D278724	38.7	6513	6826	7103	7491	7896	8627	9358
U4D308724	42.8	7146	7492	7761	8193	8646	9453	10260
U4D338724	46.8	7376	7735	8010	8455	8927	9765	10603
U4D368724	50.9	7605	7970	8262	8717	9208	10068	10928
U4D249024	35.8	6076	6371	6556	6915	7376	8060	8744
U4D279024	40.0	6777	7104	7347	7750	8220	8984	9748
U4D309024	44.2	7486	7851	8127	8588	9063	9904	10745
U4D339024	48.4	7726	8102	8393	8860	9349	10220	11091
U4D369024	42.6	7967	8350	8648	9129	9636	10536	11436

• Includes three adjustable shelves in upper section.

U4D249324	37.0	6335	6649	6845	7214	7703	8416	9129
U4D279324	41.3	7118	7466	7714	8134	8632	9432	10232
U4D309324	45.7	7903	8283	8582	9059	9563	10447	11331
U4D339324	50.0	8152	8550	8858	9348	9857	10778	11699
U4D369324	54.3	8402	8811	9125	9634	10160	11105	12050

• Includes four adjustable shelves in upper section.

• Shipped with loose toe space unless Attach Toekick or Flush Toekick is specified.

U4D249624	38.1	6595	6919	7131	7515	8023	8776	9529
U4D279624	42.6	7455	7820	8081	8524	9043	9887	10731
U4D309624	47.1	8320	8717	9026	9526	10055	10982	11909
U4D339624	51.6	8578	8996	9314	9829	10365	11332	12299
U4D369624	56.1	8838	9272	9600	10132	10683	11678	12673

• Includes four adjustable shelves in upper section.

• Shipped with loose toe space unless Attach Toekick or Flush Toekick is specified.

• Flush Toekick option not available in conjunction with Wide Top Rail unless loose Flush Toekick is specified.

Notes below apply to all products in section above:

- Large opening on tall doors will include two center panels divided by a horizontal rail.
- Drawers are the same size as on a standard 34 1/2" high four drawer base.
- Reduced Depths available in 1/4" increments from 12" to 23 3/4".

Door & Drawer Options

AF	CC	CG	GAMD	IFHG	MD	MFO	PRMD	SGLPN ¹	SHMD	SPLTDR
✓	✓			✓		✓		✓		✓

End Panel Options

AUTH	CSFPE	EXBK	FFD	FL/FR	FPE	INTGE	IPE
✓	✓	✓	✓	✓	✓	✓	✓

Custom Modification Options

ATTK ²	CBO	CCO	CFNTO	CFRMO	CLIP	CND	CSDGBK	DRT	DRWTK	EX	EX_OL	FLUT	FTK	ID	IH	IW ³	LIGHT	MIP	OBRB
✓	✓	✓	✓	✓	✓	✓	✓	✓	✓	✓	✓	✓	✓	✓	✓	✓	✓	✓	✓

RD	RECTK	RH	ROSLUT	RT	SRT	TD	TKP ⁴	TVR	VTK	WS ⁵	WTR
✓	✓	✓	✓	✓	✓	✓	✓	✓	✓	✓	✓

¹ Only available on 96" high.

² Only available on 93" or 96" high.

³ Not available on 36" wide.

⁴ Not available on 93"-96" high.

⁵ Not available on 24" wide.

Utility Inverted Cabinets

UTILITY INVERTED, 84", 87", 90", 93", or 96" HIGH, 24" DEEP

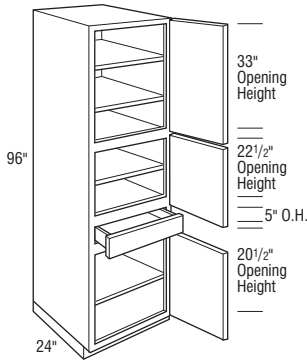
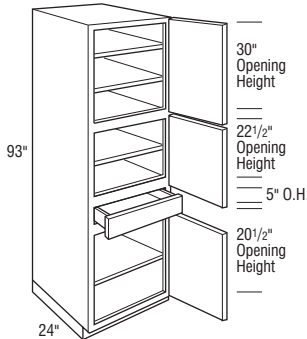
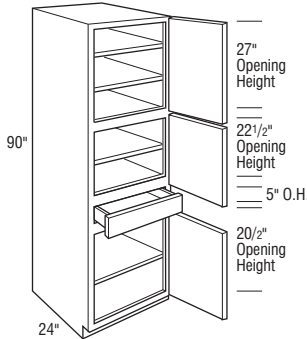
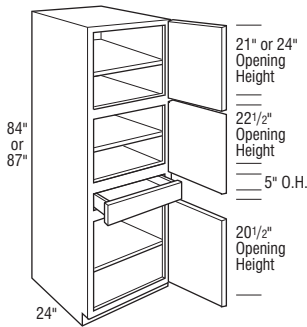

Cubic Feet	1	2	3	4	5	6	7
UI128424 L or R	17.7	2785	2893	2979	3116	3261	3779
UI158424 L or R	21.6	2902	3018	3112	3248	3409	3945
UI188424 L or R	25.6	3053	3179	3277	3430	3588	4182
UI218424 L or R	29.5	3213	3340	3448	3608	3780	4398
UI248424 L or R	33.4	3372	3512	3622	3785	3980	4628
UI128724 L or R	18.3	2882	2997	3087	3230	3384	3920
UI158724 L or R	22.4	3026	3144	3243	3392	3560	4122
UI188724 L or R	26.5	3182	3315	3416	3574	3746	4364
UI218724 L or R	30.5	3329	3467	3574	3742	3925	4569
UI248724 L or R	34.6	3478	3627	3736	3911	4111	4783

• Includes three adjustable shelves.

UI129024 L or R	18.9	2979	3105	3191	3339	3506	4062
UI159024 L or R	23.2	3143	3273	3378	3534	3705	4311
UI189024 L or R	27.4	3312	3447	3550	3719	3902	4546
UI219024 L or R	31.6	3448	3588	3703	3878	4073	4731
UI249024 L or R	35.8	3586	3737	3853	4035	4242	4942

• Includes four adjustable shelves.
• Toekick shipped attached unless otherwise specified.

UI129324 L or R	19.6	3128	3248	3347	3501	3673	4261
UI159324 L or R	23.9	3296	3428	3537	3705	3881	4517
UI189324 L or R	28.3	3465	3608	3723	3900	4088	4770
UI219324 L or R	32.6	3591	3739	3855	4042	4247	4931
UI249324 L or R	37.0	3719	3876	3993	4188	4403	5139

• Includes four adjustable shelves.
• Shipped with loose toe space unless Attach Toekick or Flush Toekick is specified.

UI129624 L or R	20.2	3277	3393	3501	3663	3839	4455
UI159624 L or R	24.7	3447	3586	3700	3876	4055	4725
UI189624 L or R	29.2	3620	3772	3892	4079	4274	4984
UI219624 L or R	33.6	3734	3892	4012	4206	4420	5136
UI249624 L or R	38.1	3848	4014	4137	4338	4563	5331

• Includes four adjustable shelves.
• Shipped with loose toe space unless Attach Toekick or Flush Toekick is specified.
• Flush Toekick option not available in conjunction with Wide Top Rail unless loose Flush Toekick is specified.

Notes below apply to all products in section above:

• Reduced Depths available in 1/4" increments from 12" to 23 3/4".

Door & Drawer Options

AF	CC	CG	GAMD	IFHG	MD	MFO	PRMD ¹	SGLPN	SHMD ²	SPLITDR
✓	✓	✓	✓	✓	✓	✓	✓	✓	✓	✓

End Panel Options

AUTH	CSFPE	EXBK	FFD	FL/FR	FPE	INTGE	IPE
✓	✓	✓	✓	✓	✓	✓	✓

Custom Modification Options

ATTK ³	CBO	CCO	CFNT0	CFRMO	CLIP ⁴	CND	CSDGBK	DRT	DRWTK	EX	EX_OL	FLUT ⁵	FTK ⁶	ID	IH	IW	LIGHT	MIP	OBRB	
✓	✓	✓	✓	✓	✓	✓	✓	✓	✓	✓	✓	✓	✓	✓	✓	✓	✓	✓	✓	✓

RD	RECTK ⁷	RH	ROSFLUT	RT	SRT	TD	TKP ⁸	TVR ¹	VTK	WS	WTR
✓	✓	✓	✓	✓	✓	✓	✓	✓	✓	✓	✓

¹ Not available on 12" wide.
² Only available on top section.
³ Only available on 93"-96" high.
⁴ Not available on 12" wide.
⁵ Not available with 6" fluting.
⁶ FTKAV and style B-L not available on 12" wide.
⁷ Only available on RECTKL.R.BK.
⁸ Not available on 93"-96" high.

IH/RH availability charts starting on page G-40.
IW/RW availability charts starting on page G-46.

Utility Inverted Cabinets & Utility with Roll Trays Cabinets

UTILITY INVERTED, 102" or 108" HIGH, 24" DEEP

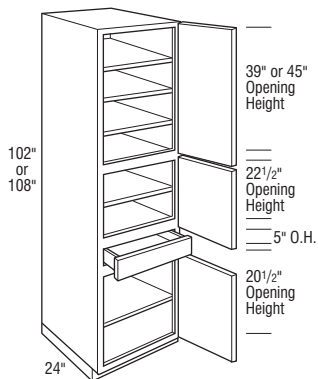

	Cubic Feet	1	2	3	4	5	6	7
UI1210224 L or R	33.8	5922	6083	6233	6457	6702	7129	7556
UI1510224 L or R	39.4	6158	6351	6509	6753	7001	7466	7931
UI1810224 L or R	45.0	6398	6609	6775	7035	7305	7798	8291
UI2110224 L or R	50.6	6556	6775	6942	7211	7508	8004	8500
UI2410224 L or R	56.3	6714	6944	7115	7394	7706	8239	8772
UI1210824 L or R	35.6	6573	6752	6918	7168	7439	7913	8387
UI1510824 L or R	41.6	6835	7049	7225	7496	7771	8287	8803
UI1810824 L or R	47.5	7102	7336	7520	7808	8109	8655	9201
UI2110824 L or R	53.4	7277	7520	7705	8004	8334	8885	9436
UI2410824 L or R	59.4	7453	7708	7898	8207	8554	9145	9736

- Includes five adjustable shelves.
- Shipped with loose toe space unless Attach Toekick or Flush Toekick is specified.
- Reduced Depths available in 1/4" increments from 12" to 23 3/4".
- Finish Flushed Ends standard.

Door & Drawer Options

AF	CC	CG	GAMD	IFHG	MD	MFO	PRMD ¹	SGLPN	SHMD ²	SPLITDR
✓	✓	✓	✓	✓	✓	✓	✓	✓	✓	✓

End Panel Options

AUTH	CSFPE	EXBK ³	FFD	FL/FR	FPE	INTGE	IPE
✓	✓	✓	✓	✓	✓	✓	✓

Custom Modification Options

ATTK	CBO	CCO	CFNTD	CFRMO	CLIP	CND	CSDGBK	DRT	DRWTK ⁴	EX	EX_OL	FLUT ⁵	FTK ⁶	ID	IH ⁷	IW	LIGHT	MIP	OBRB
✓	✓	✓	✓	✓	✓	✓	✓	✓	✓	✓	✓	✓	✓	✓	✓	✓	✓	✓	✓

RD	RECTK	RH ⁷	ROSLUT ⁵	RT	SRT	TD	TKP	TVR ¹	VTK	WS	WTR
✓	✓	✓	✓	✓	✓	✓	✓	✓	✓	✓	✓

- ¹ Not available on 12" wide.
² Only available on top section.
³ This modification will allow the end to extend back to a maximum of 30" deep.
⁴ Only available when used in conjunction with attach toekick modification.
⁵ Not available with 6" fluting.
⁶ FTKAV and style B-L not available on 12" wide.
⁷ Not available on 108" high.

NEW UTILITY with ROLL TRAYS, 66", 84", 87", 90", 93", 96", 102", or 108" HIGH, 24" DEEP

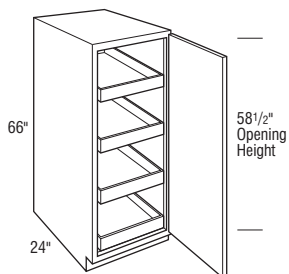

U156624RT L or R	17.0	3674	3775	3861	3986	4123	4362	4601
U186624RT L or R	20.1	3804	3914	3997	4134	4279	4535	4791
U216624RT L or R	23.1	3915	4030	4121	4262	4412	4678	4944
U246624RT L or R	26.2	4028	4147	4242	4386	4550	4830	5110

- Doors will include two center panels divided by a horizontal rail.
- Contains four easily adjustable roll trays.
- Reduced Depths available in 1/4" increments from 12" to 23 3/4".

Door & Drawer Options

AF	CC	CG	GAMD	IFHG	MD	MFO	PRMD	SGLPN	SHMD	SPLITDR
✓	✓	✓	✓	✓	✓	✓	✓	✓	✓	✓

End Panel Options

AUTH	CSFPE	EXBK	FFD	FL/FR	FPE	INTGE	IPE
✓	✓	✓	✓	✓	✓	✓	✓

Custom Modification Options

ATTK	CBO	CCO	CFNTD	CFRMO	CLIP	CND	CSDGBK	DRT	DRWTK	EX	EX_OL	FLUT ¹	FTK	ID	IH	IW	LIGHT	MIP	OBRB
✓	✓	✓	✓	✓	✓	✓	✓	✓	✓	✓	✓	✓	✓	✓	✓	✓	✓	✓	✓

RD	RECTK	RH	ROSLUT ¹	RT	SRT	TD	TKP	TVR	VTK	WS	WTR
✓	✓	✓	✓	✓	✓	✓	✓	✓	✓	✓	✓

- ¹ Not available with 6" fluting.

Utility with Roll Trays Cabinets

UTILITY with ROLL TRAYS, 66", 84", 87", 90", 93", 96", 102", or 108" HIGH, 24" DEEP (cont'd)

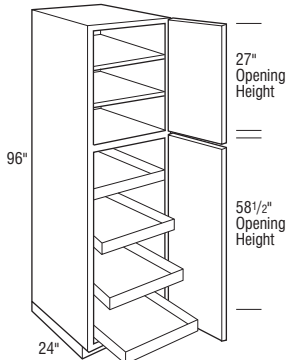
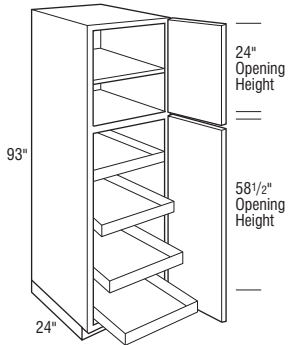
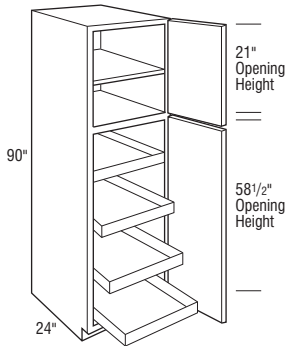
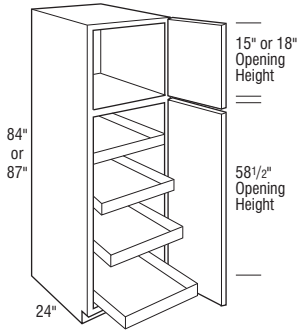

	Cubic Feet	1	2	3	4	5	6	7
U158424RT L or R	21.6	4347	4466	4559	4699	4856	5129	5402
U188424RT L or R	25.6	4501	4624	4726	4880	5038	5332	5626
U218424RT L or R	29.5	4661	4793	4894	5057	5229	5537	5845
U248424RT L or R	33.4	4814	4953	5067	5237	5430	5749	6068
U158724RT L or R	22.4	4469	4595	4691	4841	5006	5289	5572
U188724RT L or R	26.5	4632	4757	4859	5024	5195	5501	5807
U218724RT L or R	30.5	4779	4916	5024	5189	5372	5692	6012
U248724RT L or R	34.6	4927	5071	5184	5361	5558	5896	6234

U159024RTAH L or R	23.2	4593	4719	4826	4982	5154	5453	5752
U189024RTAH L or R	27.4	4755	4892	4996	5167	5349	5669	5989
U219024RTAH L or R	31.6	4894	5038	5151	5328	5515	5848	6181
U249024RTAH L or R	35.8	5035	5184	5302	5483	5688	6038	6388

- AH represents upper section alignment with doors on 24" or 27" high cabinets.
- Includes one adjustable shelf in upper section.
- Toekick shipped attached unless otherwise specified.

U159324RTAH L or R	23.9	4742	4879	4986	5152	5330	5648	5966
U189324RTAH L or R	28.3	4912	5058	5167	5344	5536	5870	6204
U219324RTAH L or R	32.6	5038	5188	5306	5489	5690	6038	6386
U249324RTAH L or R	37.0	5167	5324	5444	5634	5851	6215	6579

- AH represents upper section alignment with doors on 24" or 27" high cabinets.
- Includes one adjustable shelf in upper section.
- Shipped with loose toe space unless Attach Toekick or Flush Toekick is specified.

U159624RT L or R	24.7	4892	5035	5147	5324	5505	5838	6171
U189624RT L or R	29.2	5066	5221	5338	5525	5719	6073	6427
U219624RT L or R	33.6	5180	5338	5456	5654	5864	6231	6598
U249624RT L or R	38.1	5300	5457	5585	5783	6012	6391	6770

- Includes two adjustable shelves in upper section.
- Shipped with loose toe space unless Attach Toekick or Flush Toekick is specified.
- Flush Toekick option not available in conjunction with Wide Top Rail unless loose Flush Toekick is specified.

Notes below apply to all products in section above:

- Large opening on tall doors will include two center panels divided by a horizontal rail.
- Contains four easily adjustable roll trays.
- Reduced Depths available in 1/4" increments from 12" to 23 3/4".

Door & Drawer Options

AF	CC	CG	GAMD ¹	IFHG	MD ¹	MFO	PRMD ¹	SGLPN	SHMD ¹	SPLITDR
✓	✓	✓	✓	✓	✓	✓	✓	✓	✓	✓

End Panel Options

AUTH	CSFPE	EXBK	FFD	FL/FR	FPE	INTGE	IPE
✓	✓	✓	✓	✓	✓	✓	✓

Custom Modification Options

ATTK ²	CBO	CCO	CFNTO	CFRMO	CLIP	CND	CSDGBK	DRT	DRWTK	EX	EX_OL	FLUT ³	FTK	ID	IH ⁴	IW ⁵	LIGHT	MIP	OBRB
✓	✓	✓	✓	✓	✓	✓	✓	✓	✓	✓	✓	✓	✓	✓	✓	✓	✓	✓	✓

RD	RECTK	RH	ROSEFLUT	RT ¹	SRT	TD ¹	TKP ⁶	TVR	VTK	WS	WTR
✓	✓	✓	✓	✓	✓	✓	✓	✓	✓	✓	✓

- ¹ Only available on top section.
- ² Only available 93"-96" high.
- ³ Not available with 6" fluting.
- ⁴ Not available on 96" high.
- ⁵ Not available on 24" wide.
- ⁶ Not available on 93"-96" high.

IH/RH availability charts starting on page G•40.
IW/RW availability charts starting on page G•46.

Utility with Roll Trays Cabinets

UTILITY with ROLL TRAYS, 66", 84", 87", 90", 93", 96", 102", or 108" HIGH, 24" DEEP (cont'd)

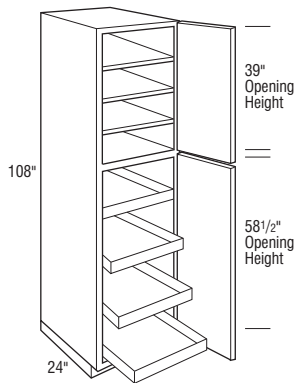
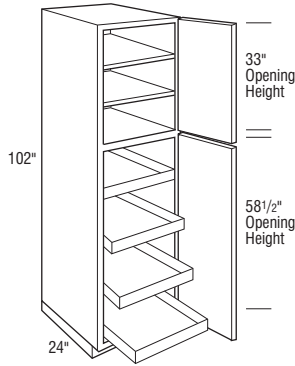

Cubic Feet	1	2	3	4	5	6	7	
U1510224RT L or R	39.4	8163	8361	8516	8762	9013	9475	9937
U1810224RT L or R	45.0	8404	8619	8781	9041	9310	9801	10292
U2110224RT L or R	50.6	8562	8781	8945	9220	9511	10021	10531
U2410224RT L or R	56.3	8729	8947	9124	9399	9717	10243	10769

• Includes two adjustable shelves in upper section.

U1510824RT L or R	41.6	9061	9281	9453	9726	10005	10517	11029
U1810824RT L or R	47.5	9329	9567	9747	10035	10334	10879	11424
U2110824RT L or R	53.4	9504	9747	9929	10234	10558	11123	11688
U2410824RT L or R	59.4	9689	9931	10128	10433	10785	11369	11953

• Includes three adjustable shelves in upper section.

Notes below apply to all products in section above:

- Shipped with loose toe space unless Attach Toekick or Flush Toekick is specified.
- Large opening on tall doors will include two center panels divided by a horizontal rail.
- Contains four easily adjustable roll trays.
- Reduced Depths available in 1/4" increments from 12" to 23 3/4".
- Finish Flushed Ends standard.

Door & Drawer Options

AF	CC	CG	GAMD ¹	IFHG	MD ¹	MFO	PRMD ¹	SGLPN	SHMD ¹	SPLITDR
✓	✓	✓	✓	✓	✓	✓	✓	✓	✓	✓

End Panel Options

AUTH	CSFPE	EXBK ²	FFD	FL/FR	FPE	INTGE	IPE
✓	✓	✓	✓	✓	✓	✓	✓

Custom Modification Options

ATTK	CBO	CCO	CFNT0	CFRMO	CLIP	CND	CSDGBK	DRT	DRWTK ³	EX	EX_OL	FLUT ⁴	FTK	ID	IH ⁵	IW ⁶	LIGHT	MIP	OBRB	
✓	✓	✓	✓	✓	✓	✓	✓	✓	✓	✓	✓	✓	✓	✓	✓	✓	✓	✓	✓	✓

RD	RECTK	RH ⁵	ROSFLUT ⁴	RT ¹	SRT	TD ¹	TKP	TVR	VTK	WS	WTR
✓	✓	✓	✓	✓	✓	✓	✓	✓	✓	✓	✓

- ¹ Only available on top section.
² This modification will allow the end to extend back to a maximum of 30" deep.
³ Only available when used in conjunction with attach toekick modification.
⁴ Not available with 6" fluting.
⁵ Not available on 108" high.
⁶ Not available on 24" wide.

NEW UTILITY with ROLL TRAYS, 66", 84", 87", 90", 93", 96", 102", or 108" HIGH, 24" DEEP (cont'd)

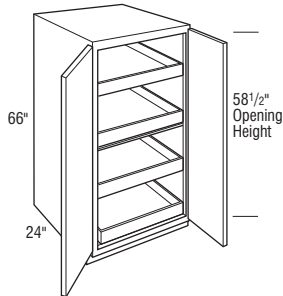

U246624RT	26.2	4691	4845	4939	5126	5363	5717	6071
U276624RT	29.3	5054	5223	5347	5555	5799	6192	6585
U306624RT	32.2	5418	5609	5751	5987	6231	6669	7107
U336624RT	35.3	5544	5735	5888	6127	6381	6831	7281
U366624RT	38.3	5668	5866	6020	6267	6530	6994	7458

- Doors will include two center panels divided by a horizontal rail.
- Contains four easily adjustable roll trays.
- Reduced Depths available in 1/4" increments from 12" to 23 3/4".

Door & Drawer Options

AF	CC	CG	GAMD	IFHG	MD	MFO	PRMD	SGLPN	SHMD	SPLITDR
✓	✓	✓	✓	✓	✓	✓	✓	✓	✓	✓

End Panel Options

AUTH	CSFPE	EXBK	FFD	FL/FR	FPE	INTGE	IPE
✓	✓	✓	✓	✓	✓	✓	✓

Custom Modification Options

ATTK	CBO	CCO	CFNT0	CFRMO	CLIP	CND	CSDGBK	DRT	DRWTK	EX	EX_OL	FLUT ¹	FTK	ID	IH	IW	LIGHT	MIP	OBRB
✓	✓	✓	✓	✓	✓	✓	✓	✓	✓	✓	✓	✓	✓	✓	✓	✓	✓	✓	✓

RD	RECTK	RH	ROSFLUT ¹	RT	SRT	TD	TKP	TVR	VTK	WS	WTR
✓	✓	✓	✓	✓	✓	✓	✓	✓	✓	✓	✓

¹ Not available with 6" fluting.

Utility with Roll Trays Cabinets

UTILITY with ROLL TRAYS, 66", 84", 87", 90", 93", 96", 102", or 108" HIGH, 24" DEEP (cont'd)

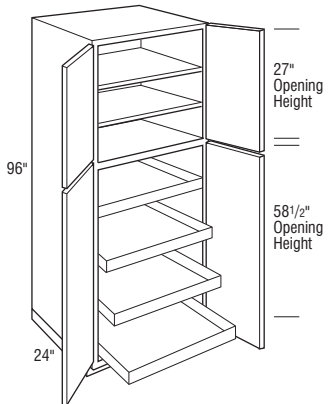
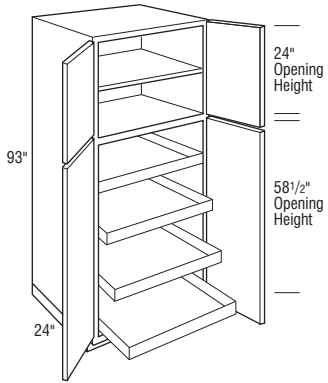
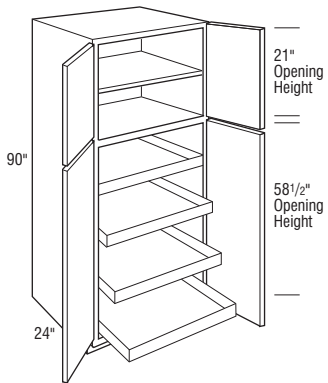
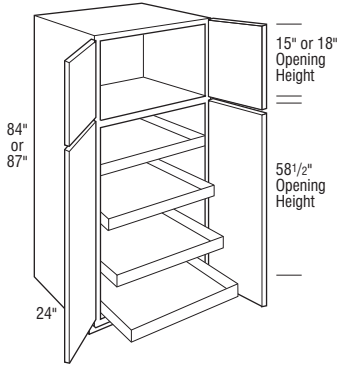

	Cubic Feet	1	2	3	4	5	6	7
U248424RT	33.4	5601	5782	6029	6242	6392	6809	7226
U278424RT	37.4	5970	6168	6374	6612	6827	7280	7733
U308424RT	41.3	6334	6551	6712	6980	7257	7755	8253
U338424RT	45.2	6477	6696	6868	7142	7435	7949	8463
U368424RT	49.2	6618	6843	7019	7304	7610	8136	8662
U248724RT	34.6	5734	5918	6104	6324	6549	6975	7401
U278724RT	38.7	6147	6350	6527	6777	7040	7510	7980
U308724RT	42.8	6556	6778	6953	7231	7524	8042	8560
U338724RT	46.8	6704	6936	7113	7401	7705	8243	8781
U368724RT	50.9	6850	7087	7274	7568	7885	8439	8993

U249024RTAH	35.8	5864	6056	6174	6407	6704	7146	7588
U279024RTAH	40.0	6318	6529	6684	6944	7249	7740	8231
U309024RTAH	44.2	6773	7011	7189	7484	7789	8336	8883
U339024RTAH	48.4	6930	7169	7360	7659	7976	8539	9102
U369024RTAH	52.6	7085	7332	7525	7834	8162	8742	9322

- AH represents upper section alignment with doors on 24" or 27" high cabinets.
- Includes one adjustable shelf in upper section.
- Toekick shipped attached unless otherwise specified.

U249324RTAH	37.0	6033	6236	6359	6597	6914	7372	7830
U279324RTAH	41.3	6536	6762	6921	7194	7514	8031	8548
U309324RTAH	45.7	7044	7290	7479	7788	8112	8685	9258
U339324RTAH	50.0	7203	7461	7658	7975	8306	8897	9488
U369324RTAH	54.3	7366	7628	7831	8161	8501	9111	9721

- AH represents upper section alignment with doors on 24" or 27" high cabinets.
- Includes one adjustable shelf in upper section.
- Shipped with loose toe space unless Attach Toekick or Flush Toekick is specified.

U249624RT	38.1	6200	6409	6547	6794	7119	7606	8093
U279624RT	42.6	6755	6990	7160	7443	7778	8323	8868
U309624RT	47.1	7313	7568	7769	8091	8432	9031	9630
U339624RT	51.6	7477	7749	7954	8284	8631	9257	9883
U369624RT	56.1	7647	7926	8136	8481	8836	9479	10122

- Includes two adjustable shelves in upper section.
- Shipped with loose toe space unless Attach Toekick or Flush Toekick is specified.
- Flush Toekick option not available in conjunction with Wide Top Rail unless loose Flush Toekick is specified.

Notes below apply to all products in section above:

- Large opening on tall doors will include two center panels divided by a horizontal rail.
- Contains four easily adjustable roll trays.
- Reduced Depths available in 1/4" increments from 12" to 23 3/4".

Door & Drawer Options

AF	CC	CG	GAMD ¹	IFHG	MD ¹	MFO	PRMD ¹	SGLPN	SHMD ¹	SPLITDR
✓	✓	✓	✓	✓	✓	✓	✓	✓	✓	✓

End Panel Options

AUTH	CSFPE	EXBK	FFD	FL/FR	FPE	INTGE	IPE
✓	✓	✓	✓	✓	✓	✓	✓

Custom Modification Options

ATTK ²	CBO ³	CCO	CFNTO ⁴	CFRMO ⁴	CLIP ⁵	CND	CSDGBK	DRT	DRWTK	EX	EX_OL	FLUT ⁶	FTK	ID	IH ⁷	IW ⁸	LIGHT	MIP	OBRB
✓	✓	✓	✓	✓	✓	✓	✓	✓	✓	✓	✓	✓	✓	✓	✓	✓	✓	✓	✓

RD	RECTK ⁹	RH	ROSLUT	RT ¹	SRT	TD ¹	TKP ¹⁰	TVR	VTK	WS	WTR
✓	✓	✓	✓	✓	✓	✓	✓	✓	✓	✓	✓

- ¹ Only available on top section.
- ² Only available on 93"-96" high.
- ³ Only available on 24" wide.
- ⁴ Not available on 24" wide.
- ⁵ Not available on 24" wide. Not available with 6" clipped corners.
- ⁶ Not available with 6" fluting.
- ⁷ Not available on 96" high.
- ⁸ Not available on 36" wide.
- ⁹ Only available on RECTKL.R.BK.
- ¹⁰ Not available on 93"-96" high.

IH/RH availability charts starting on page G-40.
IW/RW availability charts starting on page G-46.

Utility with Roll Trays Cabinets

UTILITY with ROLL TRAYS, 66", 84", 87", 90", 93", 96", 102", or 108" HIGH, 24" DEEP (cont'd)

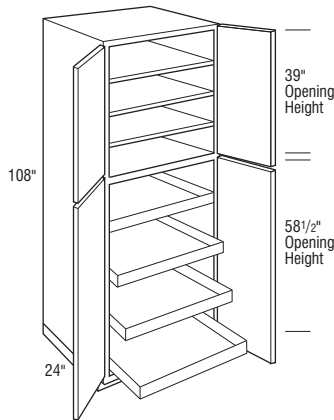
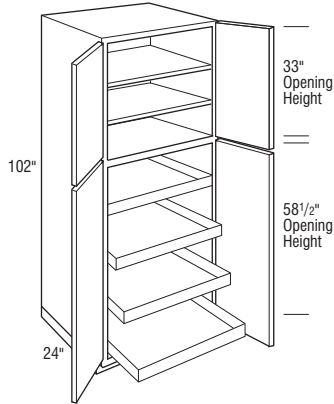

Cubic Feet	1	2	3	4	5	6	7	
U2410224RT	56.3	9978	10267	10459	10802	11253	11928	12603
U2710224RT	61.9	10748	11074	11310	11702	12167	12923	13679
U3010224RT	67.5	11522	11876	12154	12601	13074	13906	14738
U3310224RT	73.1	11749	12127	12411	12869	13351	14219	15087
U3610224RT	78.8	11985	12372	12664	13142	13635	14527	15419

• Includes two adjustable shelves in upper section.

U2410824RT	59.4	11075	11397	11609	11990	12490	13240	13990
U2710824RT	65.3	11930	12292	12554	12989	13505	14345	15185
U3010824RT	71.3	12789	13182	13491	13987	14513	15435	16357
U3310824RT	77.2	13042	13461	13776	14285	14819	15783	16747
U3610824RT	83.1	13304	13733	14057	14588	15135	16125	17115

• Includes three adjustable shelves in upper section.

Notes below apply to all products in section above:

- Shipped with loose toe space unless Attach Toekick or Flush Toekick is specified.
- Large opening on tall doors will include two center panels divided by a horizontal rail.
- Contains four easily adjustable roll trays.
- Reduced Depths available in 1/4" increments from 12" to 23 3/4".
- Finish Flushed Ends standard.

Door & Drawer Options

AF	CC	CG	GAMD ¹	IFHG	MD ¹	MFO	PRMD ¹	SGLPN	SHMD ¹	SPLITDR
✓	✓	✓	✓	✓	✓	✓	✓	✓	✓	✓

End Panel Options

AUTH	CSFPE	EXBK ²	FFD	FL/FR	FPE	INTGE	IPE
✓	✓	✓	✓	✓	✓	✓	✓

Custom Modification Options

ATTK	CBO	CCO	CFNTO	CFRMO	CLIP	CND	CSDGBK	DRT	DRWTK ³	EX	EX_OL	FLUT ⁴	FTK	ID	IH ⁵	IW ⁶	LIGHT	MIP	OBRB	
✓	✓	✓	✓	✓	✓	✓	✓	✓	✓	✓	✓	✓	✓	✓	✓	✓	✓	✓	✓	✓

RD	RECTK	RH ⁵	ROSFLUT ⁴	RT ¹	SRT	TD ¹	TKP	TVR	VTK	WS	WTR
✓	✓	✓	✓	✓	✓	✓	✓	✓	✓	✓	✓

¹ Only available on top section.

² This modification will allow the end to extend back to a maximum of 30" deep.

³ Only available when used in conjunction with attach toekick modification.

⁴ Not available with 6" fluting.

⁵ Not available on 108" high.

⁶ Not available on 36" wide.

Tall Pantry Pull-outs

TALL PANTRY PULL-OUT, 66", 84", 87", 90", 93", or 96" HIGH, 24" DEEP
L O G I X

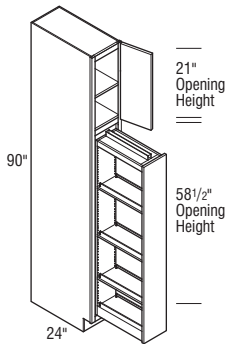
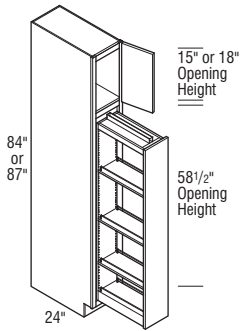
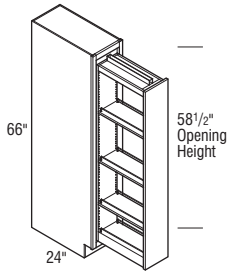

	Cubic Feet	1	2	3	4	5	6	7
TPP96624	10.9	4528	4627	4703	4831	4971	5207	5443
TPP126624	14.0	4669	4771	4849	4981	5125	5368	5611
TPP156624	17.1	4960	5072	5161	5298	5444	5702	5960
TPP186624	20.2	5301	5415	5510	5658	5808	6086	6364

• This unit is not designed to be freestanding. It must be bolted or screwed to the wall. Failure to do so will result in the unit tipping forward and will invalidate the product warranty.

TPP98424 L or R	13.8	4763	4878	4959	5099	5242	5503	5764
TPP128424 L or R	17.7	4908	5019	5106	5243	5394	5653	5912
TPP158424 L or R	21.6	5221	5338	5431	5574	5733	6002	6271
TPP188424 L or R	25.6	5576	5701	5800	5955	6114	6409	6704
TPP98724 L or R	14.3	4859	4975	5058	5200	5346	5612	5878
TPP128724 L or R	18.3	5009	5129	5215	5361	5511	5787	6063
TPP158724 L or R	22.4	5344	5468	5564	5717	5880	6168	6456
TPP188724 L or R	26.5	5704	5833	5938	6098	6271	6577	6883

TPP99024AH L or R	14.8	4954	5078	5168	5311	5462	5739	6016
TPP129024AH L or R	18.9	5106	5234	5328	5476	5632	5915	6198
TPP159024AH L or R	23.2	5468	5595	5698	5856	6029	6328	6627
TPP189024AH L or R	27.4	5831	5966	6073	6243	6425	6748	7071

- AH represents upper section alignment with doors on 24" or 27" high cabinets.
- Toekick shipped attached unless otherwise specified.

Notes below apply to all products in section above:

- Pull-outs include adjustable wood/chrome shelves.
- Large opening on tall doors will include two center panels divided by a horizontal rail.
- Not available on Inset and Beaded Inset styles.

Door & Drawer Options

AF	CC	CG ¹	GAMD ²	IFHG	MD ²	MFO	PRMD ³	SGLPN	SHMD ²	SPLITDR
		✓	✓		✓	✓	✓	✓	✓	✓

End Panel Options

AUTH	CSFPE	EXBK	FFD	FL/FR	FPE	INTGE	IPE
✓	✓	✓	✓	✓	✓	✓	✓

Custom Modification Options

ATTK	CBO	CCO	CFNTO	CFRMO	CLIP	CND ¹	CSDGBK	DRT	DRWTK	EX	EX_OL	FLUT ⁴	FTK ⁵	ID	IH ⁶	IW	LIGHT	MIP	OBRB
						✓	✓				✓	✓	✓	✓	✓	✓	✓	✓	✓

RD	RECTK ⁷	RH	ROSELLUT	RT ²	SRT	TD ¹	TKP	TVR ³	VTK	WS ⁸	WTR
	✓		✓	✓	✓	✓	✓	✓	✓	✓	✓

- ¹ Not available on 66" high and only available on top section.
- ² Not available on 66" high and only available on top section and not available with 9" wide.
- ³ Only available on 15"-18" wide. Not available on 66" high. Only available on top section.
- ⁴ Not available with 6" fluting.
- ⁵ FTKAV and style B-L not available on 12" wide.
- ⁶ Not available on 66" high.
- ⁷ Only available on RECTKL.R.BK.
- ⁸ Not available on 9" wide.

IH/RH availability charts starting on page G•40.
 IW/RW availability charts starting on page G•46.

Tall Pantry Pull-outs

TALL PANTRY PULL-OUT, 66", 84", 87", 90", 93", or 96" HIGH, 24" DEEP (cont'd) L G I X

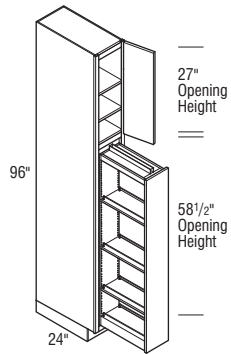
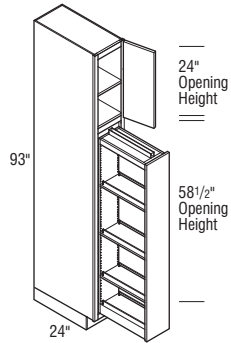

	Cubic Feet	1	2	3	4	5	6	7
TPP99324AH L or R	15.3	5090	5217	5312	5466	5629	5912	6195
TPP129324AH L or R	19.6	5248	5380	5478	5635	5803	6096	6389
TPP159324AH L or R	23.9	5616	5751	5858	6029	6204	6522	6840
TPP189324AH L or R	28.3	5990	6134	6243	6420	6612	6949	7286

- AH represents upper section alignment with doors on 24" or 27" high cabinets.
- Shipped with loose toe space unless Attach Toekick or Flush Toekick is specified.

TPP99624 L or R	15.7	5228	5362	5460	5626	5789	6091	6393
TPP129624 L or R	20.2	5389	5528	5629	5799	5968	6278	6588
TPP159624 L or R	24.7	5763	5909	6018	6199	6381	6713	7045
TPP189624 L or R	29.2	6142	6294	6414	6602	6797	7149	7501

- Shipped with loose toe space unless Attach Toekick or Flush Toekick is specified.
- Flush Toekick option not available in conjunction with Wide Top Rail unless loose Flush Toekick is specified.

Notes below apply to all products in section above:

- Pull-outs include adjustable wood/chrome shelves.
- Large opening on tall doors will include two center panels divided by a horizontal rail.
- Not available on Inset and Beaded Inset styles.

Door & Drawer Options

AF	CC	CG ¹	GAMD ²	IFHG	MD ²	MFO	PRMD ³	SGLPN	SHMD ²	SPLITDR
		✓	✓		✓	✓	✓	✓	✓	✓

End Panel Options

AUTH	CSFPE	EXBK	FFD	FL/FR	FPE	INTGE	IPE
✓	✓	✓		✓	✓	✓	✓

Custom Modification Options

ATTK	CBO	CCO	CFNT0	CFRMO	CLIP	CND ¹	CSDGBK	DRT	DRWTK	EX	EX_OL	FLUT ⁴	FTK ⁵	ID	IH ⁶	IW	LIGHT	MIP	OBRB
✓						✓	✓			✓	✓	✓	✓	✓	✓	✓		✓	✓

RD	RECTK ⁷	RH	ROSLUT	RT ²	SRT	TD ¹	TKP	TVR ³	VTK	WS ⁸	WTR
	✓		✓	✓	✓	✓		✓	✓	✓	✓

¹ Only available on top section.

² Only available on top section and not available with 9" wide.

³ Only available on 15"-18" wide. Only available on top section.

⁴ Not available with 6" fluting.

⁵ FTKAV and style B-L not available on 12" wide.

⁶ Not available on 96" high.

⁷ Only available on RECTKL.R.BK.

⁸ Not available on 9" wide.

Tall Pantry Pull-outs

TALL PANTRY PULL-OUT, 102" or 108" HIGH, 24" DEEP

L G I X

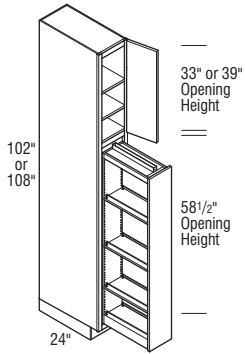

	Cubic Feet	1	2	3	4	5	6	7
TPP910224 L or R	28.1	8629	8815	8951	9181	9407	9826	10245
TPP1210224 L or R	33.8	8852	9045	9185	9421	9656	10086	10516
TPP1510224 L or R	39.4	9371	9574	9725	9976	10229	10689	11149
TPP1810224 L or R	45.0	9897	10108	10274	10535	10806	11294	11782
TPP910824 L or R	29.7	9578	9784	9935	10191	10442	10907	11372
TPP1210824 L or R	35.6	9826	10040	10196	10457	10718	11195	11672
TPP1510824 L or R	41.6	10402	10627	10795	11073	11354	11865	12376
TPP1810824 L or R	47.5	10986	11220	11405	11694	11994	12537	13080

- Shipped with loose toe space unless Attach Toekick or Flush Toekick is specified.
- Pull-outs include adjustable wood/chrome shelves.
- Large opening on tall doors will include two center panels divided by a horizontal rail.
- Not available on Inset and Beaded Inset styles.
- Finish Flushed Ends standard.

Door & Drawer Options

AF	CC	CG ¹	GAMD ²	IFHG	MD ²	MFO	PRMD ³	SGLPN	SHMD ²	SPLITDR
		✓	✓		✓	✓	✓	✓	✓	✓

End Panel Options

AUTH	CSFPE	EXBK ⁴	FFD	FL/FR	FPE	INTGE	IPE
✓		✓		✓			

Custom Modification Options

ATTK	CBO	CCO	CFNTO	CFRMO	CLIP	CND ¹	CSDGBK	DRT	DRWTK ⁵	EX	EX_OL	FLUT ⁶	FTK ⁷	ID	IH ⁸	IW	LIGHT	MIP	OBRB
✓						✓			✓	✓	✓	✓	✓	✓	✓				✓

RD	RECTK	RH ⁸	ROSLUT ⁶	RT ²	SRT	TD ¹	TKP	TVR ⁹	VTK	WS	WTR
	✓	✓	✓	✓	✓	✓		✓	✓		✓

¹ Only available on top section.

² Only available on top section and not available on 9" wide.

³ Only available on top section and not available on 9" or 12" wide.

⁴ This modification will allow the end to extend back to a maximum of 30" deep.

⁵ Only available when used in conjunction with attach toekick modification. Not available on 9" wide.

⁶ Not available with 6" fluting.

⁷ FTKAV and style B-L not available on 9" or 12" wide.

⁸ Not available on 108" high.

⁹ Only available on top section. TVRAVTOP and style B-L not available on 9" or 12" wide.

IH/RH availability charts starting on page G•40.
IW/RW availability charts starting on page G•46.

PANTRY UNIT, 84", 87", 90", 93", or 96" HIGH, 24" DEEP

L O G I X

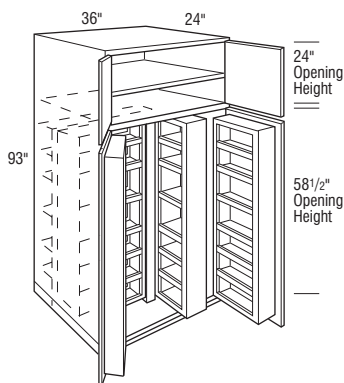
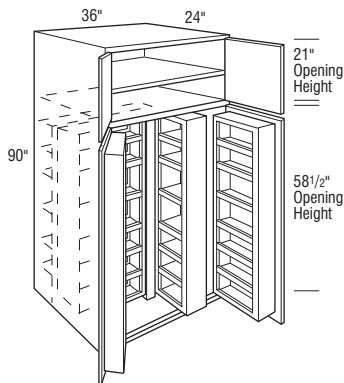
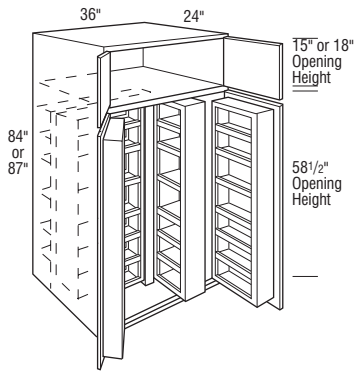

	Cubic Feet	1	2	3	4	5	6	7
PY368424	49.2	8263	8660	8966	9450	10014	10936	11858
PY368724	50.9	8520	8931	9244	9749	10326	11278	12230

PY369024AH	52.6	8776	9200	9526	10044	10640	11618	12596
-------------------	------	------	------	------	-------	-------	-------	-------

PY369324AH	54.3	9033	9471	9803	10337	10949	11959	12969
-------------------	------	------	------	------	-------	-------	-------	-------

PY369624	56.1	9292	9738	10083	10631	11261	12298	13335
-----------------	------	------	------	-------	-------	-------	-------	-------

- AH represents upper section alignment with doors on 24" or 27" high cabinets.
- Includes one adjustable shelf in upper section.
- Toekick shipped attached unless otherwise specified.

- Includes one adjustable shelf in upper section.
- Shipped with loose toe space unless Attach Toekick or Flush Toekick is specified.

- Includes two adjustable shelves in upper section.
- Shipped with loose toe space unless Attach Toekick or Flush Toekick is specified.
- Flush Toekick option not available in conjunction with Wide Top Rail unless loose Flush Toekick is specified.

Notes below apply to all products in section above:

- Large opening on tall doors will include two center panels divided by a horizontal rail.
- Door mounted racks include six adjustable shelves and one fixed shelf.
- Ten 6 1/4" deep adjustable shelves located behind pull-out.
- Swing-outs include four adjustable shelves and three fixed shelves.
- Swing-outs and door mounted racks have 4 1/2" deep adjustable shelves that are a natural finished wood with metallic finish wire rail fronts.
- Unit can be used next to wall without use of a filler.
- Not available on Inset and Beaded Inset styles.

Door & Drawer Options

AF	CC	CG ¹	GAMD ¹	IFHG	MD ¹	MFO	PRMD ¹	SGLPN	SHMD ¹	SPLITDR
✓	✓	✓	✓	✓	✓	✓	✓	✓	✓	✓

End Panel Options

AUTH	CSFPE	EXBK	FFD	FL/FR	FPE	INTGE	IPE
✓	✓	✓	✓	✓	✓	✓	✓

Custom Modification Options

ATTK ²	CBO	CCO	CFNTO	CFRMO	CLIP	CND ¹	CSDGBK	DRT	DRWTK ³	EX	EX_OL	FLUT ⁴	FTK	ID	IH ⁵	IW	LIGHT	MIP	OBRB
✓	✓	✓	✓	✓	✓	✓	✓	✓	✓	✓	✓	✓	✓	✓	✓	✓	✓	✓	✓

RD	RECTK	RH	ROSFLUT	RT ¹	SRT	TD ¹	TKP ⁶	TVR	VTK	WS	WTR
✓	✓	✓	✓	✓	✓	✓	✓	✓	✓	✓	✓

- ¹ Only available on top section.
² Only available on 93" or 96" high.
³ 93" and 96" high are not available except when used in conjunction with attach toekick modification.
⁴ Not available with 6" fluting.
⁵ Not available on 96" high.
⁶ Not available on 93"-96" high.

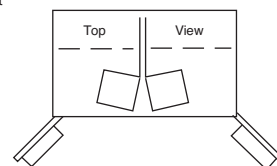
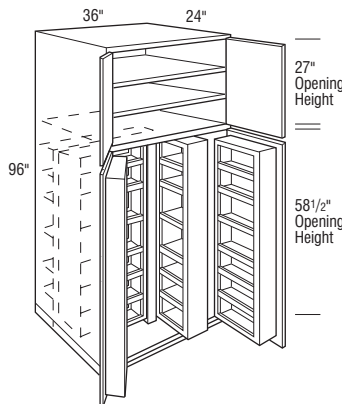

Pantry Cabinets

PANTRY UNIT, 102" or 108" HIGH, 24" DEEP

L O G I X

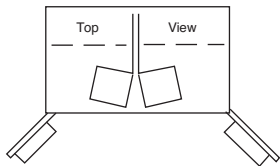
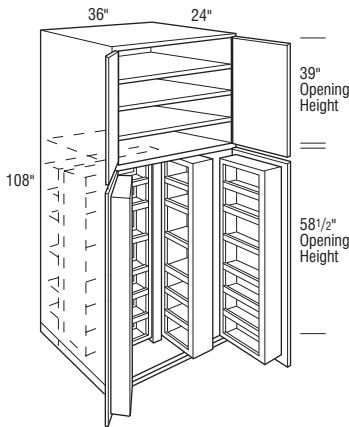
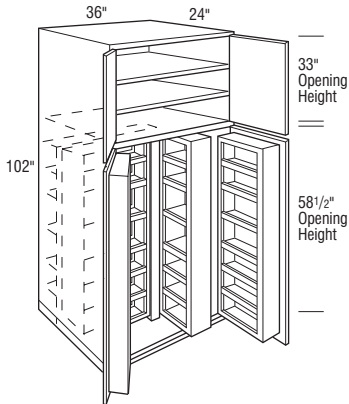

	Cubic Feet	1	2	3	4	5	6	7
PY3610224	78.8	14268	14886	15365	16126	17000	18438	19876
PY3610824	83.1	15837	16524	17055	17899	18870	20467	22064

• Includes two adjustable shelves in upper section.

PY3610824
• Includes three adjustable shelves in upper section.

Notes below apply to all products in section above:

- Shipped with loose toe space unless Attach Toekick or Flush Toekick is specified.
- Large opening on tall doors will include two center panels divided by a horizontal rail.
- Door mounted racks include six adjustable shelves and one fixed shelf.
- Ten 6 1/4" deep adjustable shelves located behind pull-out.
- Swing-outs include four adjustable shelves and three fixed shelves.
- Swing-outs and door mounted racks have 4 1/2" deep adjustable shelves that are a natural finished wood with metallic finish wire rail fronts.
- Unit can be used next to wall without use of a filler.
- Not available on Inset and Beaded Inset styles.
- Finish Flushed Ends standard.

Door & Drawer Options

AF	CC	CG	GAMD ¹	IFHG	MD ¹	MFO	PRMD ¹	SGLPN	SHMD ¹	SPLITDR
✓	✓	✓	✓	✓	✓	✓	✓	✓	✓	✓

End Panel Options

AUTH	CSFPE	EXBK ²	FFD	FL/FR	FPE	INTGE	IPE
✓	✓	✓	✓	✓	✓	✓	✓

Custom Modification Options

ATTK	CBO	CCO	CFNTO	CFRMO	CLIP	CND ¹	CSDGBK	DRT	DRWTK ³	EX	EX_OL	FLUT ⁴	FTK	ID	IH ⁵	IW	LIGHT	MIP	OBRB	
✓	✓	✓	✓	✓	✓	✓	✓	✓	✓	✓	✓	✓	✓	✓	✓	✓	✓	✓	✓	✓

RD	RECTK	RH ⁵	ROSLUT ⁴	RT ¹	SRT	TD ¹	TKP	TVR	VTK	WS	WTR
✓	✓	✓	✓	✓	✓	✓	✓	✓	✓	✓	✓

- ¹ Only available on top section.
- ² This modification will allow the end to extend back to a maximum of 30" deep.
- ³ Only available when used in conjunction with attach toekick modification.
- ⁴ Not available with 6" fluting.
- ⁵ Not available on 108" high.

IH/RH availability charts starting on page G•40.
IW/RW availability charts starting on page G•46.

UTILITY ORGANIZER CABINET, 84", 87", 90", 93", or 96" HIGH, 6" DEEP

L O G I X

Cubic Feet	1	2	3	4	5	6	7
UOC24846 L or R	10.7	2532	2656	2749	2897	3068	3642
UOC24876 L or R	11.1	2661	2790	2887	3046	3227	3821

- Includes four adjustable shelves.

UOC24906 L or R	11.5	2788	2920	3026	3186	3378	3689	4000
UOC24936 L or R	11.9	2936	3080	3186	3361	3561	3887	4213

- Includes five adjustable shelves.

UOC24966 L or R	12.2	3091	3239	3356	3536	3748	4093	4438
------------------------	------	------	------	------	------	------	------	------

- Includes six adjustable shelves.

Notes below apply to all products in section above:

- Finish Flushed Ends standard.
- Large opening on tall doors will include two center panels divided by a horizontal rail.
- Void toekick standard.
- Field installs on side of 24" deep tall cabinet.
- Cabinet includes a broom clip (included in cabinet un-installed) that can be used instead of shelves in lower section.
- Broom clip installation instructions included.

Door & Drawer Options

AF	CC	CG	GAMD ¹	IFHG	MD ¹	MFO	PRMD ¹	SGLPN	SHMD ¹	SPLITDR
✓	✓	✓	✓	✓	✓	✓	✓	✓	✓	✓

End Panel Options

AUTH	CSFPE	EXBK	FFD	FL/FR	FPE	INTGE	IPE
✓							

Custom Modification Options

ATTK	CBO	CCO	CFNT0	CFRMO	CLIP	CND	CSDGBK	DRT	DRWTK	EX	EX_OL	FLUT ²	FTK	ID	IH ³	IW	LIGHT	MIP	OBRB
✓	✓	✓	✓	✓	✓	✓	✓	✓	✓	✓	✓	✓	✓	✓	✓	✓	✓	✓	✓

RD	RECTK	RH	ROSLUT	RT	SRT	TD	TKP	TVR	VTK	WS	WTR
			✓						✓	✓	✓

¹ Only available on top section.

² Not available with 6" fluting.

³ Not available on 96" high.

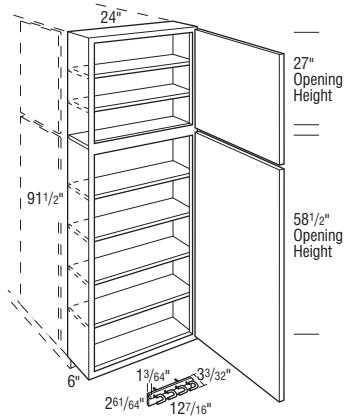
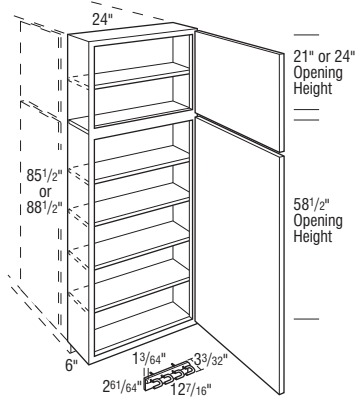
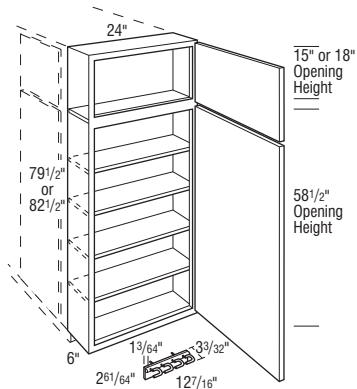

Utility Organizer Cabinets

UTILITY ORGANIZER CABINET, 102" or 108" HIGH, 6" DEEP L G | X

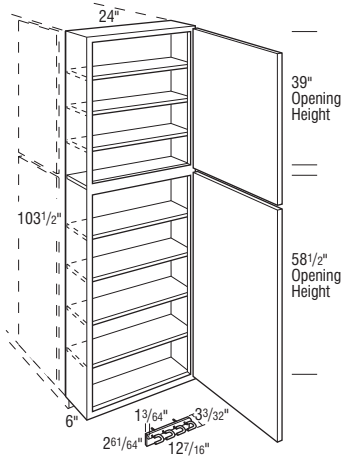
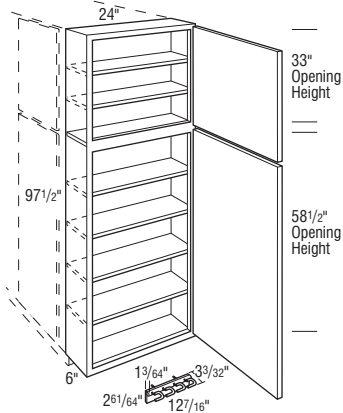

Cubic Feet	1	2	3	4	5	6	7	
UOC241026 L or R	22.5	5664	5869	6031	6281	6575	7054	7533
UOC241086 L or R	23.8	6287	6515	6695	6972	7299	7830	8361

UOC241026 L or R

- Includes six adjustable shelves.

UOC241086 L or R

- Includes seven adjustable shelves.

Notes below apply to all products in section above:

- Finish Flushed Ends standard.
- Large opening on tall doors will include two center panels divided by a horizontal rail.
- Void toekick standard.
- Field installs on side of 24" deep tall cabinet.
- Cabinet includes a broom clip (included in cabinet un-installed) that can be used instead of shelves in lower section.
- Broom clip installation instructions included.

Door & Drawer Options

AF	CC	CG	GAMD ¹	IFHG	MD ¹	MFO	PRMD ¹	SGLPN	SHMD ¹	SPLITDR
✓	✓	✓	✓	✓	✓	✓	✓	✓	✓	✓

End Panel Options

AUTH	CSFPE	EXBK	FFD	FL/FR	FPE	INTGE	IPE
✓	✓	✓	✓	✓	✓	✓	✓

Custom Modification Options

ATTK	CBO	CCO	CFNTO	CFRMO	CLIP	CND	CSDGBK	DRT	DRWTK ²	EX	EX_OL	FLUT ³	FTK	ID	IH ⁴	IW	LIGHT	MIP	OBRB	
✓	✓	✓	✓	✓	✓	✓	✓	✓	✓	✓	✓	✓	✓	✓	✓	✓	✓	✓	✓	✓

RD	RECTK	RH ⁴	ROSLUT ³	RT	SRT	TD	TKP	TVR	VTK	WS	WTR
✓	✓	✓	✓	✓	✓	✓	✓	✓	✓	✓	✓

¹ Only available on top section.

² Only available when used in conjunction with attach toekick modification.

³ Not available with 6" fluting.

⁴ Not available on 108" high.

IH/RH availability charts starting on page G•40.
IW/RW availability charts starting on page G•46.

Utility Organizer Cabinets

UTILITY ORGANIZER CABINET, 84", 87", 90", 93", or 96" HIGH, 6" DEEP

L O G I X

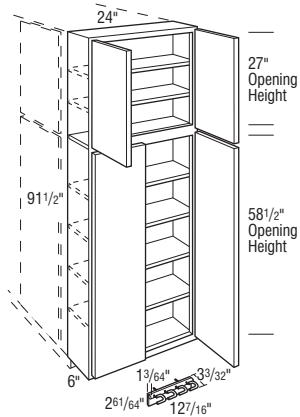
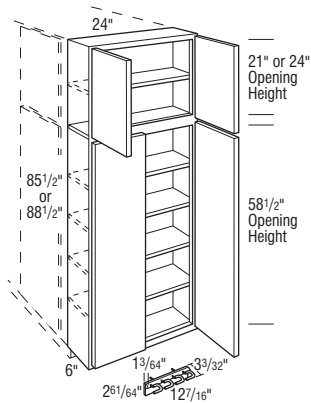
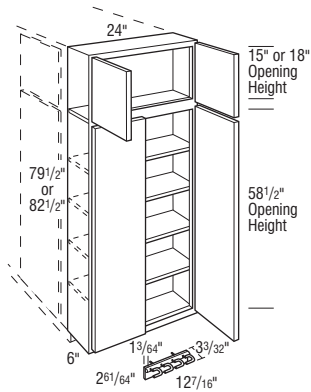

Cubic Feet	1	2	3	4	5	6	7	
UOC24846	10.7	3296	3456	3575	3772	3993	4365	4737
UOC24876	11.1	3446	3611	3737	3943	4174	4559	4944

- Includes four adjustable shelves.

UOC24906AH	11.5	3593	3769	3900	4112	4356	4758	5160
UOC24936AH	11.9	3775	3957	4098	4318	4576	4998	5420

- AH represents upper section alignment with doors on 24" or 27" high cabinets.
- Includes five adjustable shelves.

UOC24966	12.2	3955	4146	4292	4526	4793	5237	5681
-----------------	------	------	------	------	------	------	------	------

- Includes six adjustable shelves.

Notes below apply to all products in section above:

- Finish Flushed Ends standard.
- Large opening on tall doors will include two center panels divided by a horizontal rail.
- Void toekick standard.
- Field installs on side of 24" deep tall cabinet.
- Cabinet includes a broom clip (included in cabinet un-installed) that can be used instead of shelves in lower section.
- Broom clip installation instructions included.

Door & Drawer Options

AF	CC	CG	GAMD ¹	IFHG	MD ¹	MFO	PRMD ¹	SGLPN	SHMD ¹	SPLITDR
✓	✓	✓	✓	✓	✓	✓	✓	✓	✓	✓

End Panel Options

AUTH	CSFPE	EXBK	FFD	FL/FR	FPE	INTGE	IPE
✓	✓	✓	✓	✓	✓	✓	✓

Custom Modification Options

ATTK	CBO	CCO	CFNT0	CFRMO	CLIP	CND	CSDGBK	DRT	DRWTK	EX	EX_OL	FLUT ²	FTK	ID	IH ³	IW	LIGHT	MIP	OBRB	
✓	✓	✓	✓	✓	✓	✓	✓	✓	✓	✓	✓	✓	✓	✓	✓	✓	✓	✓	✓	✓

RD	RECTK	RH	ROSLUT	RT	SRT	TD	TKP	TVR	VTK	WS	WTR
✓	✓	✓	✓	✓	✓	✓	✓	✓	✓	✓	✓

¹ Only available on top section.

² Not available with 6" fluting.

³ Not available on 96" high.

Utility Organizer Cabinets

UTILITY ORGANIZER CABINET, 102" or 108" HIGH, 6" DEEP

L O G I X

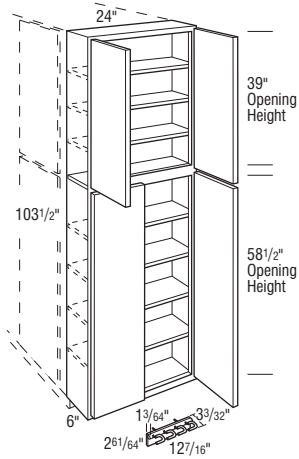
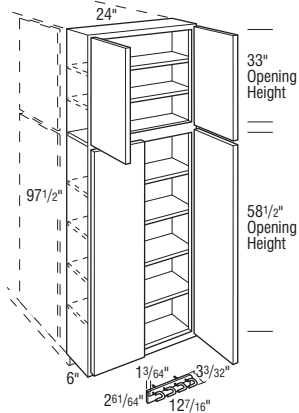

Cubic Feet	1	2	3	4	5	6	7	
UOC241026	22.5	6863	7128	7330	7655	8025	8641	9257
UOC241086	23.8	7617	7912	8136	8497	8908	9592	10276

UOC241026

- Includes six adjustable shelves.

UOC241086

- Includes seven adjustable shelves.

Notes below apply to all products in section above:

- Finish Flushed Ends standard.
- Large opening on tall doors will include two center panels divided by a horizontal rail.
- Void toekick standard.
- Field installs on side of 24" deep tall cabinet.
- Cabinet includes a broom clip (included in cabinet un-installed) that can be used instead of shelves in lower section.
- Broom clip installation instructions included.

Door & Drawer Options

AF	CC	CG	GAMD ¹	IFHG	MD ¹	MFO	PRMD ¹	SGLPN	SHMD ¹	SPLITDR
✓	✓	✓	✓	✓	✓	✓	✓	✓	✓	✓

End Panel Options

AUTH	CSFPE	EXBK	FFD	FL/FR	FPE	INTGE	IPE
✓	✓	✓	✓	✓	✓	✓	✓

Custom Modification Options

ATTK	CBO	CCO	CFNTO	CFRMO	CLIP	CND	CSDGBK	DRT	DRWTK ²	EX	EX_OL	FLUT ³	FTK	ID	IH ⁴	IW	LIGHT	MIP	OBRB	
✓	✓	✓	✓	✓	✓	✓	✓	✓	✓	✓	✓	✓	✓	✓	✓	✓	✓	✓	✓	✓

RD	RECTK	RH ⁴	ROSLUT ³	RT	SRT	TD	TKP	TVR	VTK	WS	WTR
✓	✓	✓	✓	✓	✓	✓	✓	✓	✓	✓	✓

¹ Only available on top section.

² Only available when used in conjunction with attach toekick modification.

³ Not available with 6" fluting.

⁴ Not available on 108" high.

IH/RH availability charts starting on page G•40.
IW/RW availability charts starting on page G•46.

UTILITY ORGANIZER CABINET, 84", 87", 90", 93", or 96" HIGH, 9" DEEP

L O G I X

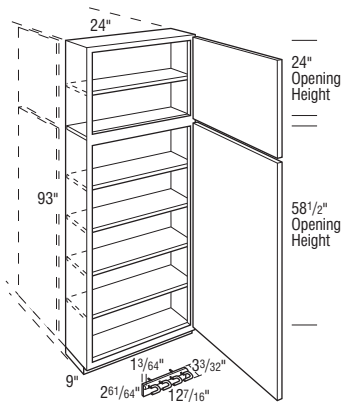
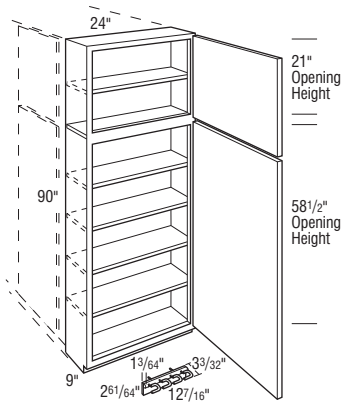
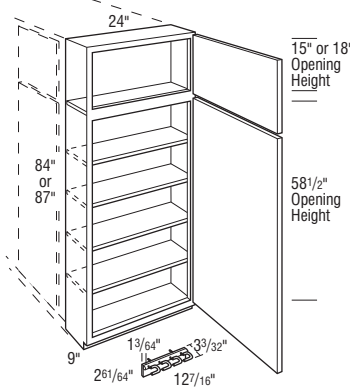

	Cubic Feet	1	2	3	4	5	6	7
UOC24849 L or R	14.5	2532	2656	2749	2897	3068	3355	3642
UOC24879 L or R	15.0	2661	2790	2887	3046	3227	3524	3821
UOC24909 L or R	15.5	2788	2920	3026	3186	3378	3689	4000
UOC24939 L or R	16.0	2936	3080	3186	3361	3561	3887	4213
UOC24969 L or R	16.5	3091	3239	3356	3536	3748	4093	4438

- Includes four adjustable shelves.

- Includes five adjustable shelves.

- Includes five adjustable shelves.
- Shipped with loose toe space unless Attach Toekick or Flush Toekick is specified.

- Includes six adjustable shelves.
- Shipped with loose toe space unless Attach Toekick or Flush Toekick is specified.
- Flush Toekick option not available in conjunction with Wide Top Rail unless a Flush Toekick Loose is specified.

Notes below apply to all products in section above:

- Finish Flushed Ends standard.
- Large opening on tall doors will include two center panels divided by a horizontal rail.
- Field installs on side of 24" deep tall cabinet.
- Cabinet includes a broom clip (included in cabinet un-installed) that can be used instead of shelves in lower section.
- Broom clip installation instructions included.
- Increased Depths available in 1/4" increments from 9 1/4" to 30".

Door & Drawer Options

AF	CC	CG	GAMD ¹	IFHG	MD ¹	MFO	PRMD ¹	SGLPN	SHMD ¹	SPLITDR
<input checked="" type="checkbox"/>	<input checked="" type="checkbox"/>	<input checked="" type="checkbox"/>	<input checked="" type="checkbox"/>	<input checked="" type="checkbox"/>	<input checked="" type="checkbox"/>	<input checked="" type="checkbox"/>	<input checked="" type="checkbox"/>	<input checked="" type="checkbox"/>	<input checked="" type="checkbox"/>	<input checked="" type="checkbox"/>

End Panel Options

AUTH	CSFPE	EXBK	FFD	FL/FR	FPE	INTGE	IPE
<input checked="" type="checkbox"/>	<input checked="" type="checkbox"/>	<input type="checkbox"/>	<input type="checkbox"/>	<input type="checkbox"/>	<input type="checkbox"/>	<input type="checkbox"/>	<input type="checkbox"/>

Custom Modification Options

ATTK ²	CBO	CCO	CFNT0	CFRMO	CLIP	CND	CSDGBK	DRT	DRWTK	EX	EX_OL	FLUT ³	FTK	ID	IH ⁴	IW	LIGHT	MIP	OBRB
<input checked="" type="checkbox"/>	<input checked="" type="checkbox"/>	<input checked="" type="checkbox"/>	<input checked="" type="checkbox"/>	<input checked="" type="checkbox"/>	<input checked="" type="checkbox"/>	<input checked="" type="checkbox"/>	<input checked="" type="checkbox"/>	<input checked="" type="checkbox"/>	<input checked="" type="checkbox"/>	<input checked="" type="checkbox"/>	<input checked="" type="checkbox"/>	<input checked="" type="checkbox"/>	<input checked="" type="checkbox"/>	<input checked="" type="checkbox"/>	<input checked="" type="checkbox"/>	<input checked="" type="checkbox"/>	<input checked="" type="checkbox"/>	<input checked="" type="checkbox"/>	<input checked="" type="checkbox"/>

RD	RECTK	RH	ROSLUT	RT	SRT	TD	TKP ⁵	TVR	VTK	WS	WTR
<input checked="" type="checkbox"/>	<input checked="" type="checkbox"/>	<input checked="" type="checkbox"/>	<input checked="" type="checkbox"/>	<input checked="" type="checkbox"/>	<input checked="" type="checkbox"/>	<input checked="" type="checkbox"/>	<input checked="" type="checkbox"/>	<input checked="" type="checkbox"/>	<input checked="" type="checkbox"/>	<input checked="" type="checkbox"/>	<input checked="" type="checkbox"/>

¹ Only available on top section.

² Only available on 93"-96" high.

³ Not available with 6" fluting.

⁴ Not available on 96" high.

⁵ Not available on 93"-96" high.

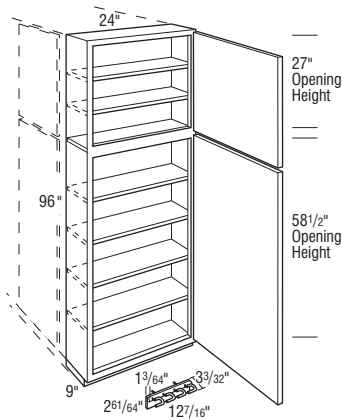

Utility Organizer Cabinets

UTILITY ORGANIZER CABINET, 102" or 108" HIGH, 9" DEEP

L O G I X

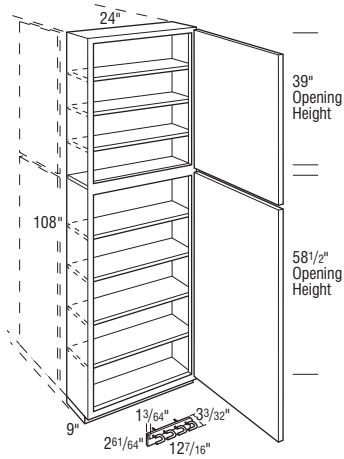
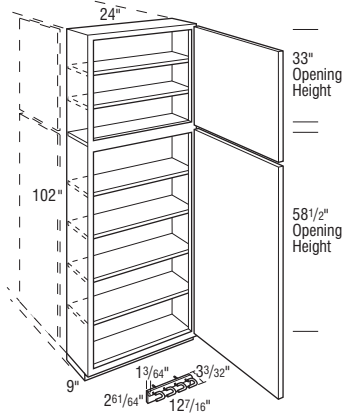

Cubic Feet	1	2	3	4	5	6	7	
UOC241029 L or R	28.1	5664	5869	6031	6281	6575	7054	7533
UOC241089 L or R	29.7	6287	6515	6695	6972	7299	7830	8361

• Includes six adjustable shelves.

• Includes seven adjustable shelves.

Notes below apply to all products in section above:

- Finish Flushed Ends standard.
- Shipped with loose toe space unless Attach Toekick or Flush Toekick is specified.
- Large opening on tall doors will include two center panels divided by a horizontal rail.
- Field installs on side of 24" deep tall cabinet.
- Cabinet includes a broom clip (included in cabinet un-installed) that can be used instead of shelves in lower section.
- Broom clip installation instructions included.
- Increased Depths available in 1/4" increments from 9 1/4" to 26".

Door & Drawer Options

AF	CC	CG	GAMD ¹	IFHG	MD ¹	MFO	PRMD ¹	SGLPN	SHMD ¹	SPLITDR
✓	✓	✓	✓	✓	✓	✓	✓	✓	✓	✓

End Panel Options

AUTH	CSFPE	EXBK	FFD	FL/FR	FPE	INTGE	IPE
✓							

Custom Modification Options

ATTK	CBO	CCO	CFNTO	CFRMO	CLIP	CND	CSDGBK	DRT	DRWTK ²	EX	EX_OL	FLUT ³	FTK	ID	IH ⁴	IW	LIGHT	MIP	OBRB	
✓	✓	✓	✓	✓		✓			✓	✓	✓	✓	✓	✓	✓					✓

RD	RECTK	RH ⁴	ROSFLUT ³	RT	SRT	TD	TKP	TVR	VTK	WS	WTR
	✓	✓	✓			✓	✓	✓	✓	✓	✓

¹ Only available on top section.

² Only available when used in conjunction with attach toekick modification.

³ Not available with 6" fluting.

⁴ Not available on 108" high.

IH/RH availability charts starting on page G-40.
IW/RW availability charts starting on page G-46.

Utility Organizer Cabinets

UTILITY ORGANIZER CABINET, 84", 87", 90", 93", or 96" HIGH, 9" DEEP

L O G I X

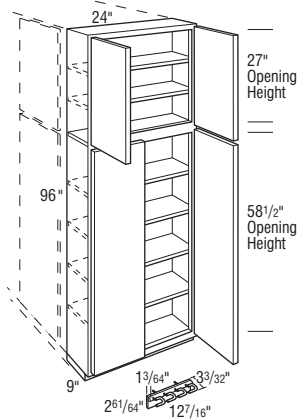
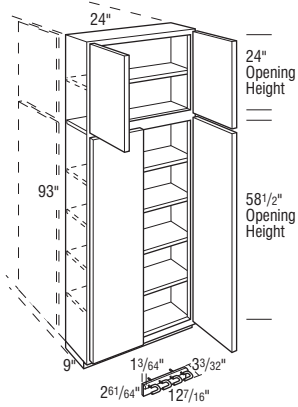
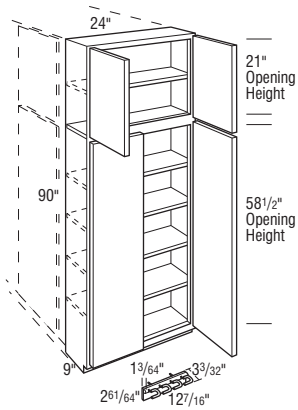
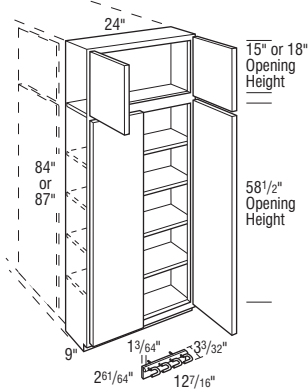

Cubic Feet	1	2	3	4	5	6	7	
UOC24849	14.5	3296	3456	3575	3772	3993	4365	4737
UOC24879	15.0	3446	3611	3737	3943	4174	4559	4944
UOC24909	15.5	3593	3769	3900	4112	4356	4758	5160
UOC24939	16.0	3775	3957	4098	4318	4576	4998	5420
UOC24969	16.5	3955	4146	4292	4526	4793	5237	5681

- Includes four adjustable shelves.

- Includes five adjustable shelves.

- Includes five adjustable shelves.
- Shipped with loose toe space unless Attach Toekick or Flush Toekick is specified.

- Includes six adjustable shelves.
- Shipped with loose toe space unless Attach Toekick or Flush Toekick is specified.
- Flush Toekick option not available in conjunction with Wide Top Rail unless a Flush Toekick Loose is specified.

Notes below apply to all products in section above:

- Finish Flushed Ends standard.
- Large opening on tall doors will include two center panels divided by a horizontal rail.
- Field installs on side of 24" deep tall cabinet.
- Cabinet includes a broom clip (included in cabinet un-installed) that can be used instead of shelves in lower section.
- Broom clip installation instructions included.
- Increased Depths available in 1/4" increments from 9 1/4" to 30".

Door & Drawer Options

AF	CC	CG	GAMD ¹	IFHG	MD ¹	MFO	PRMD ¹	SGLPN	SHMD ¹	SPLITDR
✓	✓	✓	✓	✓	✓	✓	✓	✓	✓	✓

End Panel Options

AUTH	CSFPE	EXBK	FFD	FL/FR	FPE	INTGE	IPE
✓	✓	✓	✓	✓	✓	✓	✓

Custom Modification Options

ATTK ²	CBO	CCO	CFNTO	CFRMO	CLIP	CND	CSDGBK	DRT	DRWTK	EX	EX	OL	FLUT ³	FTK	ID	IH ⁴	IW	LIGHT	MIP	OBRB	
✓	✓	✓	✓	✓	✓	✓	✓	✓	✓	✓	✓	✓	✓	✓	✓	✓	✓	✓	✓	✓	✓

RD	RECTK	RH	ROSLUT	RT	SRT	TD	TKP ⁵	TVR	VTK	WS	WTR
✓	✓	✓	✓	✓	✓	✓	✓	✓	✓	✓	✓

- ¹ Only available on top section.
- ² Only available on 93"-96" high.
- ³ Not available with 6" fluting.
- ⁴ Not available on 96" high.
- ⁵ Not available on 93"-96" high.

Utility Organizer Cabinets

UTILITY ORGANIZER CABINET, 102" or 108" HIGH, 9" DEEP

L O G I X

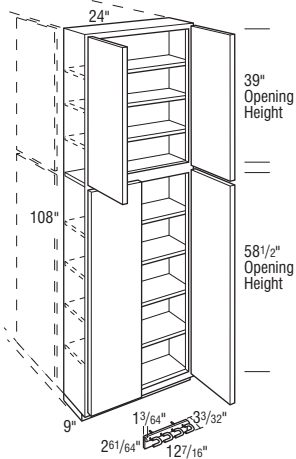
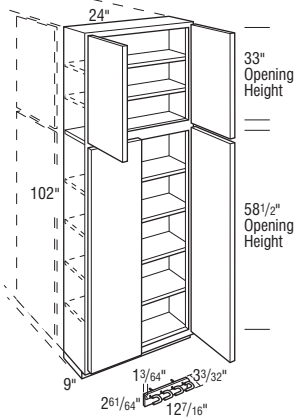

Cubic Feet	1	2	3	4	5	6	7	
UOC241029	28.1	6863	7128	7330	7655	8025	8641	9257
UOC241089	29.7	7617	7912	8136	8497	8908	9592	10276

UOC241029

- Includes six adjustable shelves.

UOC241089

- Includes seven adjustable shelves.

Notes below apply to all products in section above:

- Finish Flushed Ends standard.
- Shipped with loose toe space unless Attach Toekick or Flush Toekick is specified.
- Large opening on tall doors will include two center panels divided by a horizontal rail.
- Field installs on side of 24" deep tall cabinet.
- Cabinet includes a broom clip (included in cabinet un-installed) that can be used instead of shelves in lower section.
- Broom clip installation instructions included.
- Increased Depths available in 1/4" increments from 9 1/4" to 26".

Door & Drawer Options

AF	CC	CG	GAMD ¹	IFHG	MD ¹	MFO	PRMD ¹	SGLPN	SHMD ¹	SPLITDR
✓	✓	✓	✓	✓	✓	✓	✓	✓	✓	✓

End Panel Options

AUTH	CSFPE	EXBK	FFD	FL/FR	FPE	INTGE	IPE
✓							

Custom Modification Options

ATTK	CBO	CCO	CFNTO	CFRMO	CLIP	CND	CSDGBK	DRT	DRWTK ²	EX	EX_OL	FLUT ³	FTK	ID	IH ⁴	IW	LIGHT	MIP	OBRB	
✓	✓	✓	✓	✓		✓			✓	✓	✓	✓	✓	✓	✓					✓

RD	RECTK	RH ⁴	ROSLUT ³	RT	SRT	TD	TKP	TVR	VTK	WS	WTR
	✓	✓	✓			✓	✓	✓	✓	✓	✓

¹ Only available on top section.

² Only available when used in conjunction with attach toekick modification.

³ Not available with 6" fluting.

⁴ Not available on 108" high.

IH/RH availability charts starting on page G•40.
IW/RW availability charts starting on page G•46.

UTILITY ORGANIZER DROP ZONE CABINET, 84", 87", 93", or 96" HIGH, 9" DEEP
L O G I X

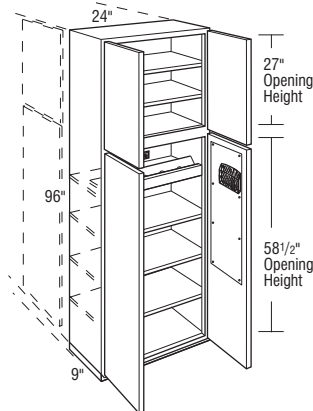
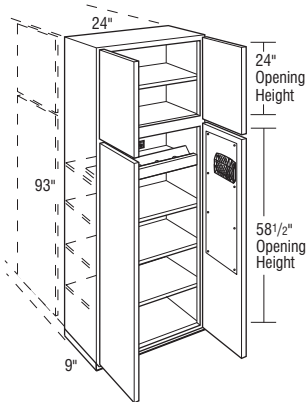
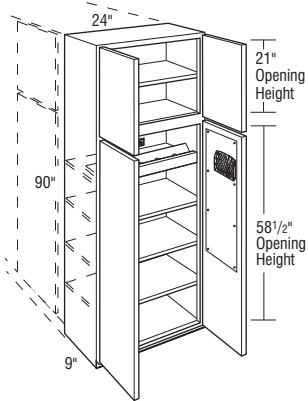
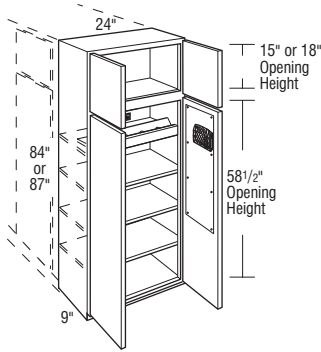

Cubic Feet	1	2	3	4	5	6	7
UOCDZ24849	14.5	3604	3960	4314	4669	4844	5200
UOCDZ24879	15.0	3754	4115	4476	4840	5025	5407
UOCDZ24909	15.5	3901	4273	4639	5009	5207	5623
UOCDZ24939	16.0	4083	4461	4837	5215	5427	5883
UOCDZ24969	16.5	4263	4650	5031	5423	5644	6144

• Includes three adjustable shelves.

• Includes four adjustable shelves.

• Includes four adjustable shelves.

• Shipped with loose toe space unless Attach Toekick or Flush Toekick is specified.

• Includes five adjustable shelves.

• Shipped with loose toe space unless Attach Toekick or Flush Toekick is specified.

• Flush Toekick option not available in conjunction with Wide Top Rail unless a Flush Toekick Loose is specified.

Notes below apply to all products in section above:

- Finish Flushed Ends standard.
- Features magnetic whiteboards on back of lower doors, one magnetic black mesh pencil holder, charging station shelf, power strip, black plastic grommet for power cord, key hooks, and coat hooks.
- Charging station shelf is adjustable, features four cord cut-out areas.
- Power strip is UL listed with three standard 110-volt plug-ins and one USB charging port.
- Field installs on side of 24" deep tall cabinet.
- Large opening on tall doors will include two center panels divided by a horizontal rail.
- Increased Depths available in 1/4" increments from 9 1/4" to 30".
- Not available on Inset and Beaded Inset styles.

Door & Drawer Options

AF	CC	CG	GAMD	IFHG	MD ¹	MFO	PRMD	SGLPN	SHMD ¹	SPLITDR
✓	✓	✓	✓	✓	✓	✓	✓	✓	✓	✓

End Panel Options

AUTH	CSFPE	EXBK	FFD	FL/FR	FPE	INTGE	IPE
✓	✓	✓	✓	✓	✓	✓	✓

Custom Modification Options

ATTK ²	CBO	CCO	CFNTO	CFRMO	CLIP	CND	CSDGBK	DRT	DRWTK	EX	EX_OL	FLUT ³	FTK	ID	IH ⁴	IW	LIGHT	MIP	OBRB
✓	✓	✓	✓	✓	✓	✓	✓	✓	✓	✓	✓	✓	✓	✓	✓	✓	✓	✓	✓

RD	RECTK	RH	ROSLUT	RT	SRT	TD ¹	TKP ⁵	TVR	VTK	WS	WTR
✓	✓	✓	✓	✓	✓	✓	✓	✓	✓	✓	✓

- ¹ Only available on top section.
- ² Only available on 93"-96" high.
- ³ Not available with 6" fluting.
- ⁴ Not available on 96" high.
- ⁵ Not available 93"-96" high.

Utility Organizer Cabinets

UTILITY ORGANIZER DROP ZONE CABINET, 102" or 108" HIGH, 9" DEEP

L O G I X

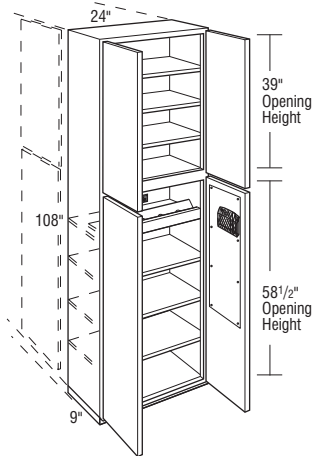
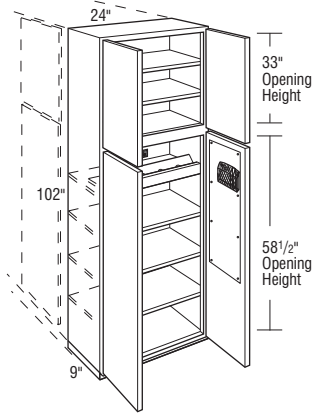

Cubic Feet	1	2	3	4	5	6	7	
UOCDZ241029	28.1	7290	7827	8356	8899	9206	9553	9900
UOCDZ241089	29.7	8092	8688	9275	9878	10219	10604	10989

• Includes five adjustable shelves.

• Includes six adjustable shelves.

Notes below apply to all products in section above:

- Shipped with loose toe space unless Attach Toekick or Flush Toekick is specified.
- Finish Flushed Ends standard.
- Features magnetic whiteboards on back of lower doors, one magnetic black mesh pencil holder, charging station shelf, power strip, black plastic grommet for power cord, key hooks and coat hooks.
- Charging station shelf is adjustable, features four cord cut-out areas.
- Power strip is UL listed with three standard 110-volt plug-ins and one USB charging port.
- Field installs on side of 24" deep tall cabinet.
- Large opening on tall doors will include two center panels divided by a horizontal rail.
- Increased Depths available in 1/4" increments from 9 1/4" to 26".
- Not available on Inset and Beaded Inset styles.

Door & Drawer Options

AF	CC	CG	GAMD	IFHG	MD ¹	MFO	PRMD ¹	SGLPN	SHMD ¹	SPLITDR
✓					✓	✓	✓	✓	✓	

End Panel Options

AUTH	CSFPE	EXBK	FFD	FL/FR	FPE	INTGE	IPE
✓							

Custom Modification Options

ATTK	CBO	CCO	CFNTO	CFRMO	CLIP	CND	CSDGBK	DRT	DRWTK ²	EX	EX_OL	FLUT ³	FTK	ID	IH ⁴	IW	LIGHT	MIP	OBRB	
✓	✓	✓	✓			✓			✓	✓	✓	✓	✓	✓	✓					
RD	RECTK	RH ⁴	ROSFLUT ³	RT	SRT	TD ¹	TKP	TVR	VTK	WS	WTR									
✓	✓	✓	✓			✓		✓	✓	✓	✓									

¹ Only available on top section.

² Only available when used in conjunction with attach toekick modification.

³ Not available with 6" fluting.

⁴ Not available on 108" high.

IH/RH availability charts starting on page G•40.
IW/RW availability charts starting on page G•46.

Utility Organizer Cabinets

UTILITY ORGANIZER DROP ZONE CABINET with AUTHENTIC END, 84", 87", 90", 93", or 96" HIGH, 9" DEEP

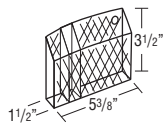
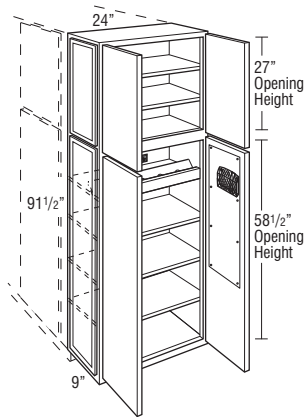
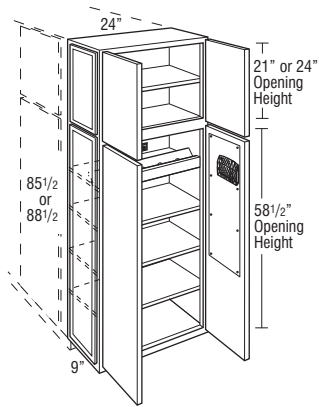
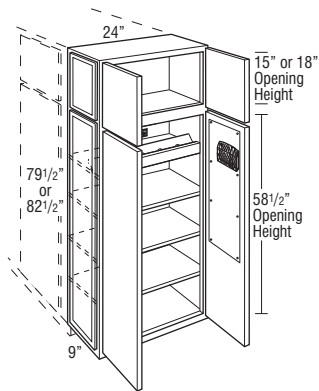

Pencil Holder

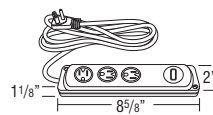

Power Strip



Grommet



Key Hooks

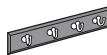

Coat Hooks

	Cubic Feet	1	2	3	4	5	6	7
UOCDZ24849AE L or R	14.5	4084	4440	4794	5149	5324	5502	5680
UOCDZ24879AE L or R	15.0	4084	4440	4794	5149	5324	5502	5680

- Three full depth adjustable shelves in lower section are included, but packaged separately.

UOCDZ24909AHA L or R	15.5	4084	4440	4794	5149	5324	5502	5680
-----------------------------	------	------	------	------	------	------	------	------

- AH represents upper section alignment with doors on 24" or 27" high cabinets.
- One full depth adjustable shelf in upper section, and three full depth adjustable shelves in lower section are included, but packaged separately.

UOCDZ24939AHA L or R	16.0	4084	4440	4794	5149	5324	5502	5680
-----------------------------	------	------	------	------	------	------	------	------

- AH represents upper section alignment with doors on 24" or 27" high cabinets.
- One full depth adjustable shelf in upper section, and three full depth adjustable shelves in lower section are included, but packaged separately.
- Shipped with loose toe space unless Attach Toekick or Flush Toekick is specified.

UOCDZ24969AE L or R	16.5	4084	4440	4794	5149	5324	5502	5680
----------------------------	------	------	------	------	------	------	------	------

- Two full depth adjustable shelves in upper section, and three full depth adjustable shelves in lower section are included, but packaged separately.
- Shipped with loose toe space unless Attach Toekick or Flush Toekick is specified.
- Flush Toekick option not available in conjunction with Wide Top Rail unless a Flush Toekick Loose is specified.

Notes below apply to all products in section above:

- Features magnetic whiteboards on back of lower doors, one magnetic black mesh pencil holder, charging station with power strip, black plastic grommet for power cord, key hooks, and coat hooks. Accessories are field installed.
- Charging station shelf is adjustable, features four cord cut-out areas.
- Power strip is UL listed with three standard 110-volt plug-ins and one USB charging port.
- Authentic Ends are standard on one side. Specify AEL model for installation on the right side of a tall cabinet. Specify AER model for installation on the left side of a tall cabinet.
- Designed to be installed onto an adjacent 24" deep tall cabinet.
- Utility cabinets with depths of 12" or less must be installed to wall studs or onto the end of another tall cabinet.
- Consult local electrical/building codes for proper installation.
- For proper installation, adjacent cabinet must have FPEB or 3/32" skin applied.
- Finish Flushed Ends standard.
- Large opening on tall doors will include two center panels divided by a horizontal rail.
- Increased Depths available in 1/4" increments from 9 1/4" to 30".
- Not available on Inset and Beaded Inset styles.

Door & Drawer Options

AF	CC	CG	GAMD	IFHG	MD	MFO	PRMD	SGLPN	SHMD	SPLITDR
✓						✓	✓	✓	✓	

End Panel Options

AUTH	CSFPE	EXBK	FFD	FL/FR	FPE	INTGE	IPE
✓	✓						

Custom Modification Options

ATTK ¹	CBO	CCO	CFNTO	CFRMO	CLIP	CND	CSDGBK	DRT	DRWTK	EX	EX_OL	FLUT	FTK	ID	IH	IW	LIGHT	MIP	OBRB	
✓	✓	✓	✓	✓	✓	✓	✓	✓	✓	✓	✓	✓	✓	✓	✓	✓	✓	✓	✓	✓

RD	RECTK	RH	RDSFLUT	RT	SRT	TD	TKP	TVR	VTK	WS	WTR
✓	✓	✓	✓	✓	✓	✓	✓	✓	✓	✓	✓

¹ Only available on 93"-96" high.

Notes









How to Use Your Diamond Edge Price List

Your Diamond Edge price guide contains charts with prices for each cabinetry product, arranged according to an alphabetical code. Use the chart below to determine the price code for your preferred cabinetry style.

Then refer to the various sections of this binder to find the types and sizes of cabinets required. Read across each chart to the column that corresponds to your style's price code to determine the price for each unit.

For example, if you want a microwave wall cabinet that is 27" wide and 30" high in the Karis Cherry style, you would

- Find the price code for Karis Cherry ("3" in the chart below)
- Refer to the "Microwave & Oven Cabinets" section of this binder
- Locate product code MW2730 (MW = microwave wall, 27 = width in inches, 30 = height in inches)
- Read across the chart in the same row to column 3 to find the price for this model in Karis Cherry

Door Styles	Alder	Cherry	Maple	MDF	Quartersawn Oak	Rustic Alder	Walnut
Brooks	3	5	3		5	3	6
Brooks Beaded Inset	3+15%	5+15%	3+15%		5+15%	3+15%	6+15%
Brooks Inset	3+15%	5+15%	3+15%		5+15%	3+15%	6+15%
Caldera 	3	5	3		5	3	6
Daxton	2	4	2		4	2	6
Daxton Beaded Inset	2+15%	4+15%	2+15%		4+15%	2+15%	6+15%
Daxton Inset	2+15%	4+15%	2+15%		4+15%	2+15%	6+15%
Gunther	1	3	1		3	1	5
Gunther Beaded Inset	1+15%	3+15%	1+15%		3+15%	1+15%	5+15%
Gunther Inset	1+15%	3+15%	1+15%		3+15%	1+15%	5+15%
Karis	1	3	1		3	1	5
Karis Beaded Inset	1+15%	3+15%	1+15%		3+15%	1+15%	5+15%
Karis Inset	1+15%	3+15%	1+15%		3+15%	1+15%	5+15%
Langley	5	6	5		6	5	7
Langley Beaded Inset	5+15%	6+15%	5+15%		6+15%	5+15%	7+15%
Langley Inset	5+15%	6+15%	5+15%		6+15%	5+15%	7+15%
Montgomery 	1	3	1		3	1	5
Montgomery Beaded Inset 	1+15%	3+15%	1+15%		3+15%	1+15%	5+15%
Montgomery Inset 	1+15%	3+15%	1+15%		3+15%	1+15%	5+15%
Shona	1	3	1		3	1	5
Shona Beaded Inset	1+15%	3+15%	1+15%		3+15%	1+15%	5+15%
Shona Inset	1+15%	3+15%	1+15%		3+15%	1+15%	5+15%
Sumner 	3	5	3		5	3	6
Tackett	2	4	2		4	2	6
Tackett Beaded Inset	2+15%	4+15%	2+15%		4+15%	2+15%	6+15%
Tackett Inset	2+15%	4+15%	2+15%		4+15%	2+15%	6+15%
Trystan 	4	6	4	1	6		7
Trystan Beaded Inset 				1+15%			
Trystan Inset 				1+15%			
Vesta	2	4	2		4	2	6
Vesta Beaded Inset	2+15%	4+15%	2+15%		4+15%	2+15%	6+15%
Vesta Inset	2+15%	4+15%	2+15%		4+15%	2+15%	6+15%
Wells 	4	6	4		6	4	7

Diamond Edge Modification Option Descriptions

Your Diamond Edge price guide contains charts with modification option codes for each applicable cabinetry product. Reference the listing below to identify the modification description.

Door & Drawer Options	
Option	Description
AF	Aluminum Door
CC	Craftsman Door
CG	Cut-for-glass
GAMD	Gallery Mullion Door
HC	Horizon Door
IFHG	Inset Finial Hinges
MC	Mission Door
MD	Mullion Door
MFO	Modified Full Overlay
PRMD	Prairie Mullion Door
SHMD	Shaker Mullion Door
SPLITDR	Split Doors
SPLITDRWS	Split Drawers

End Panel Options	
Option	Description
AUTH	Authentic Flush End
CSFPE	Car Siding Flush Panel End
EXBK	End Extended Back
EXDN	Wall End and Back Extended Down
FL/FR	Finished Ends
FPE	Flush Panel End
INTGE	Integral End
IPE	Inset Panel Ends

Custom Modification Options	
Option	Description
ADD_SHLF	Add Shelf
ADDTK	Add Toekick
ADRW	Add Drawer Below Wall Unit
ATTK	Attach Toekick
BVR	Bottom Valance Rail
CBO	Cabinet Box Only
CCO	Cabinet Case Only
CFNTO	Cabinet Front Only
CFP	Cabinet False Panel
CFRMO	Cabinet Frame Only
CLIP	Clipped Corner
CND	Cabinet No Door
CSDGBK	Car Siding Back
DRWTK	Toekick Drawer
EX	Extended Stile
EX_OL	Extended Stile with Overlay
FLUT	Fluting
FTK	Flush Toekick
ID	Increased Depth
IH	Increased Height
IW	Increased Width
MIP	Matching Interior
OBRB	Open Bottom Rail Base
PFINBTMB	Finished Bottom
RD	Reduced Depth
RECTK	Recessed Toekick
RH	Reduced Height
ROSFLUT	Rose Fluting
RT	Roll Trays
SCPDRW	Scooped Drawer
TD	Tray Divider
TKP	Toekick Pedestal
TVR	Top Valance Rail
VTK	Void Toekick
WS	Wide Stiles
WTCU	Wood Tiered Cutlery Divider Drawer
WTKCUP	Wood Tiered K-Cup Drawer
WTR	Wide Top Rail

WALL MICROWAVE CABINET, 18" or 21" HIGH

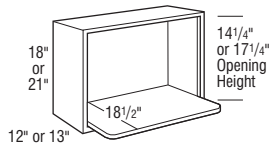

	Opening		Cabinet	
	Width	Height	Width	Height
MW2718	24"	14 1/4"	27"	18"
MW3018	27"	14 1/4"	30"	18"
MW2721	24"	17 1/4"	27"	21"
MW3021	27"	17 1/4"	30"	21"

	Cubic Feet	1	2	3	4	5	6	7
MW2718	4.6	1456	1456	1456	1456	1456	1456	1456
MW3018	6.9	1456	1456	1456	1456	1456	1456	1456
MW2721	5.4	1456	1456	1456	1456	1456	1456	1456
MW3021	8.0	1456	1456	1456	1456	1456	1456	1456

- Matching Interior standard.
- Solid-wood microwave shelf shipped unattached.
- See chart for specific model appliance opening limitations.
- Full Overlay Styles:
 - Increased Depths available in 1/4" increments from 12 1/4" to 30".
- Inset and Beaded Inset Styles:
 - Increased Depths available in 1/4" increments from 13 1/4" to 30".
- Increased depth modification will also increase the depth of the microwave shelf.
- Inset and Beaded Inset Door Styles are a standard 13" deep.

Door & Drawer Options

AF	CC	CG	GAMD	HC	IFHG	MC	MD	MFO	PRMD	SHMD	SPLITDR	SPLITDRWS
----	----	----	------	----	------	----	----	-----	------	------	---------	-----------

End Panel Options

AUTH	CSFPE	EXBK	EXDN	FL/FR	FPE	INTGE	IPE
✓	✓	✓	✓		✓	✓	✓

Custom Modification Options

ADD_SHLF	ADDTK	ADRW	ATTK	BVR	CBO	CCO	CFNT0	CFP	CFRMO	CLIP ¹	CND	CSDGBK	DRWTK	EX	EX_OL	FLUT ²	FTK	ID
✓	✓			✓	✓	✓	✓	✓	✓	✓		✓	✓	✓	✓	✓	✓	✓

IH ³	IW	MIP	OBRB	PFINBTMB	RD	RECTK	RH	ROSLUT ²	RT	SCPDWR	TD	TKP	TVR ⁴	VTK	WS	WTCD	WTKCUP	WTR
✓	✓	✓	✓	✓	✓	✓	✓	✓	✓	✓	✓	✓	✓	✓	✓	✓	✓	✓

¹ Not available with clipped both.

² Not available with fluting both or 6" fluting.

³ Not available on 21" high.

⁴ Not available on 27" wide.

Wall Microwave Cabinets

WALL MICROWAVE DOUBLE DOOR CABINET, 30" or 33" HIGH

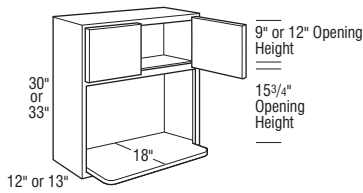

Specify appliance opening dimensions:

MW_ _
Microwave Wall
with Shelf

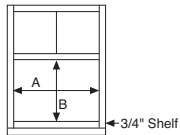

Appliance Opening Dimensions:

A _____
B _____

NOTE:

See chart for specific model appliance opening limitations.

Cabinet appliance openings may vary with modifications (i.e. clipped corner modification reduces maximum cut-out width by 3" per clipped corner).

	Cubic Feet	1	2	3	4	5	6	7
MW2430	6.7	2239	2323	2390	2501	2619	2821	3023
MW2730	7.5	2281	2369	2438	2553	2667	2869	3071
MW3030	8.3	2350	2437	2510	2624	2749	2960	3171
MW3330	9.1	2449	2539	2615	2735	2864	3084	3304
MW3630	9.9	2566	2660	2742	2868	2998	3240	3482
MW2433	7.4	2412	2502	2576	2694	2822	3037	3252
MW2733	8.3	2454	2548	2620	2746	2869	3090	3311
MW3033	9.1	2524	2619	2700	2824	2960	3182	3404
MW3333	10.0	2599	2695	2777	2904	3041	3276	3511
MW3633	10.9	2688	2788	2874	3003	3144	3397	3650

- Matching Interior standard.
- Specify cut-out size.
- When Beaded Inset is ordered, the cabinet should be ordered to the appropriate width using the 1/4" width modification instead of using the piece-in or cut-out applications.
- The maximum cut-out width is 2" less than the overall width of the cabinet. The maximum cut-out height varies depending on the cabinet.
- Shelf shipped unattached.
- Microwave shelf depth may be decreased; specify depth required.
- Microwave shelf is solid wood.
- Inset and Beaded Inset Door Styles are a standard 13" deep.
- Full Overlay Styles:
 - Reduced Depths available in 1/4" increments from 6" to 11 3/4".
- Inset and Beaded Inset Styles:
 - Reduced Depths available in 1/4" increments from 6" to 12 3/4".

	Standard Appliance Opening		Decreased Appliance Opening Width*		Increased Appliance Opening Width**		Appliance Opening Height***	
	Width (A)	Height (B)	Min. Width (A)	Max. Width (A)	Min. Width (A)	Max. Width (A)	Min. Height (B)	Max. Height (B)
MW2430	21"	15 3/4"	9"	20 1/2"	21 1/16"	22"	14"	15 3/4"
MW2730	24"	15 3/4"	12"	23 1/2"	24 1/16"	25"	14"	15 3/4"
MW3030	27"	15 3/4"	15"	26 1/2"	27 1/16"	28"	14"	15 3/4"
MW3330	30"	15 3/4"	18"	29 1/2"	30 1/16"	31"	14"	15 3/4"
MW3630	33"	15 3/4"	21"	32 1/2"	33 1/16"	34"	14"	15 3/4"
MW2433	21"	15 3/4"	9"	20 1/2"	21 1/16"	22"	14"	18 3/4"
MW2733	24"	15 3/4"	12"	23 1/2"	24 1/16"	25"	14"	18 3/4"
MW3033	27"	15 3/4"	15"	26 1/2"	27 1/16"	28"	14"	18 3/4"
MW3333	30"	15 3/4"	18"	29 1/2"	30 1/16"	31"	14"	18 3/4"
MW3633	33"	15 3/4"	21"	32 1/2"	33 1/16"	34"	14"	18 3/4"

*Decreased Appliance Opening Width can vary in 1/16" increments by piecing in frame material.

**Increased Appliance Opening Width can vary in 1/16" increments by cutting out the frame stiles.

***Appliance Opening Height could have a variance of 1/16". By changing openings, it may require the door/drawer openings to change.

Door & Drawer Options

AF	CC	CG	GAMD	HC	IFHG	MC	MD ¹	MFO	PRMD ¹	SHMD	SPLITDR	SPLITDRWS
✓	✓	✓	✓	✓	✓	✓	✓	✓	✓	✓	✓	✓

End Panel Options

AUTH	CSFPE	EXBK	EXDN	FL/FR	FPE	INTGE	IPE
✓	✓	✓	✓	✓	✓	✓	✓

Custom Modification Options

ADD	SHLF	ADDTK ²	ADRW	ATTK	BVR	CBO	CCO	CFNT0	CFP	CFRMO	CLIP	CND	CSDGBK	DRWTK	EX	EX_QL	FLUT ³	FTK	ID
✓	✓	✓	✓	✓	✓	✓	✓	✓	✓	✓	✓	✓	✓	✓	✓	✓	✓	✓	✓

IH	IW ⁴	MIP	OBRB	PFINBTMB	RD	RECTK ²	RH ⁵	ROSFLUT ⁶	RT	SCPDRW	TD ⁷	TKP ²	TVR	VTK	WS	WTCD	WTKCUP	WTR
✓	✓	✓	✓	✓	✓	✓	✓	✓	✓	✓	✓	✓	✓	✓	✓	✓	✓	✓

¹ Only available on 33" high except not available on 24" wide.

² Not available on 24" or 33" wide.

³ Not available with fluting both or with 6" fluting.

⁴ Not available on 36" wide.

⁵ Only available on 33" wide.

⁶ Not available with fluting both.

⁷ Not available on 24" wide.

IH/RH availability charts starting on page G•40.
IW/RW availability charts starting on page G•46.

WALL BUILT-IN MICROWAVE DOUBLE DOOR CABINET, 30" or 33" HIGH, 18" DEEP

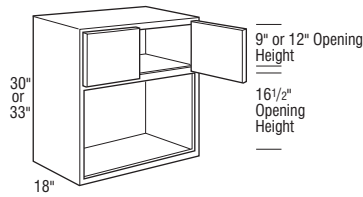

Specify appliance opening dimensions:

WBMW__18AC

Microwave Wall
18" Deep

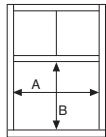

Appliance Opening Dimensions:

A _____
B _____

NOTE:

See chart for specific model appliance opening limitations.

Cabinet appliance openings may vary with modifications (i.e. clipped corner modification reduces maximum cut-out width by 3" per clipped corner).

	Cubic Feet	1	2	3	4	5	6	7
WBMW243018AC	9.4	2107	2185	2250	2353	2464	2655	2846
WBMW273018AC	10.7	2149	2235	2305	2417	2534	2736	2938
WBMW303018AC	11.8	2216	2304	2374	2487	2615	2824	3033
WBMW333018AC	13.9	2316	2404	2474	2587	2711	2918	3125
WBMW363018AC	14.0	2431	2526	2610	2735	2865	3111	3357
WBMW243318AC	10.5	2282	2366	2437	2550	2668	2875	3082
WBMW273318AC	11.7	2319	2412	2485	2613	2736	2957	3178
WBMW303318AC	12.9	2389	2484	2566	2690	2824	3048	3272
WBMW333318AC	16.3	2465	2558	2633	2756	2885	3106	3327
WBMW363318AC	15.3	2554	2652	2738	2869	3009	3262	3515

- Matching Interior standard.
- Specify cut-out size.
- When Beaded Inset is ordered, the cabinet should be ordered to the appropriate width using the 1/4" width modification instead of using the piece-in or cut-out applications.
- The maximum cut-out width is 1 1/2" less than the overall width of the cabinet. The maximum cut-out height varies depending on the cabinet.
- Reduced Depths available in 1/4" increments from 6" to 17 3/4".
- Ordering Maximum Width Cut-out on cabinet will change end panel thickness from 1/2" to 3/8" for non-flush ends, and from 5/8" to 1/2" for flush ends.

	Standard Appliance Opening		Decreased Appliance Opening Width*		Increased Appliance Opening Width**		Appliance Opening Height***	
	Width (A)	Height (B)	Min. Width (A)	Max. Width (A)	Min. Width (A)	Max. Width (A)	Min. Height (B)	Max. Height (B)
WBMW243018AC	21"	16 1/2"	9"	20 1/2"	21 1/16"	22 1/2"	14"	16 1/2"
WBMW273018AC	24"	16 1/2"	12"	23 1/2"	24 1/16"	25 1/2"	14"	16 1/2"
WBMW303018AC	27"	16 1/2"	15"	26 1/2"	27 1/16"	28 1/2"	14"	16 1/2"
WBMW333018AC	30"	16 1/2"	18"	29 1/2"	30 1/16"	31 1/2"	14"	16 1/2"
WBMW363018AC	33"	16 1/2"	21"	32 1/2"	33 1/16"	34 1/2"	14"	16 1/2"
WBMW243318AC	21"	16 1/2"	9"	20 1/2"	21 1/16"	22 1/2"	14"	19 1/2"
WBMW273318AC	24"	16 1/2"	12"	23 1/2"	24 1/16"	25 1/2"	14"	19 1/2"
WBMW303318AC	27"	16 1/2"	15"	26 1/2"	27 1/16"	28 1/2"	14"	19 1/2"
WBMW333318AC	30"	16 1/2"	18"	29 1/2"	30 1/16"	31 1/2"	14"	19 1/2"
WBMW363318AC	33"	16 1/2"	21"	32 1/2"	33 1/16"	34 1/2"	14"	19 1/2"

*Decreased Appliance Opening Width can vary in 1/16" increments by piecing in frame material.

**Increased Appliance Opening Width can vary in 1/16" increments by cutting out the frame stiles.

***Appliance Opening Height could have a variance of 1/16". By changing openings, it may require the door/drawer openings to change.

Door & Drawer Options

AF	CC	CG	GAMD ¹	HC	IFHG	MC	MD ²	MFO	PRMD ³	SHMD	SPLITDR	SPLITDRWS
✓	✓	✓	✓	✓	✓	✓	✓	✓	✓	✓	✓	✓

End Panel Options

AUTH	CSFPE ⁴	EXBK	EXDN	FL/FR	FPE	INTGE ⁴	IPE ⁴
✓	✓	✓	✓	✓	✓	✓	✓

Custom Modification Options

ADD_SHLF	ADDTK	ADRW	ATTK	BVR	CBO	CCO	CFNTO	CFP	CFRMO	CLIP	CND	CSDGBK	DRWTK	EX	EX_OL	FLUT ⁵	FTK	ID
✓	✓	✓	✓	✓	✓	✓	✓	✓	✓	✓	✓	✓	✓	✓	✓	✓	✓	✓

IH	IW ⁶	MIP	OBRB	PFINBTMB	RD	RECTK	RH	ROSLUT	RT	SCPDRW	TD ⁷	TKP	TVR	VTK	WS	WTCD	WTKCUP	WTR
✓	✓	✓	✓	✓	✓	✓	✓	✓	✓	✓	✓	✓	✓	✓	✓	✓	✓	✓

¹ Only available on 273318, 303318 and 363318 versions.

² Only available on 33" high.

³ Only available on 33" high except not available on 24" wide.

⁴ Not available when cut-out width is greater than standard.

⁵ Not available with 6" fluting.

⁶ Not available on 36" wide.

⁷ Not available on 24" wide.

Wall Microwave Cabinets

WALL MICROWAVE DOUBLE DOOR CABINET, 36" or 39" HIGH

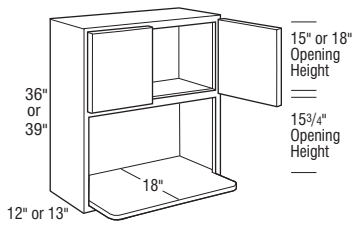

Specify appliance opening dimensions:

MW_ _
Microwave Wall
with Shelf

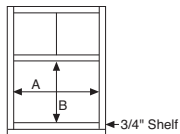

Appliance Opening Dimensions:

A _____

B _____

NOTE:

See chart for specific model appliance opening limitations.

Cabinet appliance openings may vary with modifications (i.e. clipped corner modification reduces maximum cut-out width by 3" per clipped corner).

	Cubic Feet	1	2	3	4	5	6	7
MW2436	8.0	2497	2590	2666	2789	2922	3146	3370
MW2736	9.0	2544	2641	2713	2842	2979	3213	3447
MW3036	9.9	2615	2713	2792	2924	3071	3318	3565
MW3336	10.9	2742	2850	2934	3071	3218	3475	3732
MW3636	11.8	2854	2966	3057	3203	3363	3634	3905
MW2439	8.7	2714	2815	2897	3031	3174	3419	3664
MW2739	9.7	2761	2861	2944	3084	3235	3490	3745
MW3039	10.7	2837	2944	3034	3178	3334	3603	3872
MW3339	11.7	2977	3093	3185	3334	3495	3778	4061
MW3639	12.7	3095	3219	3320	3480	3652	3951	4250

- Matching Interior standard.
- Specify cut-out size.
- When Beaded Inset is ordered, the cabinet should be ordered to the appropriate width using the 1/4" width modification instead of using the piece-in or cut-out applications.
- The maximum cut-out width is 2" less than the overall width of the cabinet. The maximum cut-out height varies depending on the cabinet.
- Shelf shipped unattached.
- Microwave shelf depth may be decreased; specify depth required.
- Microwave shelf is solid wood.
- Inset and Beaded Inset Door Styles are a standard 13" deep.
- Full Overlay Styles:
 - Reduced Depths available in 1/4" increments from 6" to 11 3/4".
- Inset and Beaded Inset Styles:
 - Reduced Depths available in 1/4" increments from 6" to 12 3/4".

	Standard Appliance Opening		Decreased Appliance Opening Width*		Increased Appliance Opening Width**		Appliance Opening Height***	
	Width (A)	Height (B)	Min. Width (A)	Max. Width (A)	Min. Width (A)	Max. Width (A)	Min. Height (B)	Max. Height (B)
MW2436	21"	15 3/4"	9"	20 1/2"	21 1/16"	22"	14"	18 3/4"
MW2736	24"	15 3/4"	12"	23 1/2"	24 1/16"	25"	14"	18 3/4"
MW3036	27"	15 3/4"	15"	26 1/2"	27 1/16"	28"	14"	18 3/4"
MW3336	30"	15 3/4"	18"	29 1/2"	30 1/16"	31"	14"	18 3/4"
MW3636	33"	15 3/4"	21"	32 1/2"	33 1/16"	34"	14"	18 3/4"
MW2439	21"	15 3/4"	9"	20 1/2"	21 1/16"	22"	14"	18 3/4"
MW2739	24"	15 3/4"	12"	23 1/2"	24 1/16"	25"	14"	18 3/4"
MW3039	27"	15 3/4"	15"	26 1/2"	27 1/16"	28"	14"	18 3/4"
MW3339	30"	15 3/4"	18"	29 1/2"	30 1/16"	31"	14"	18 3/4"
MW3639	33"	15 3/4"	21"	32 1/2"	33 1/16"	34"	14"	18 3/4"

*Decreased Appliance Opening Width can vary in 1/16" increments by piecing in frame material.

**Increased Appliance Opening Width can vary in 1/16" increments by cutting out the frame stiles.

***Appliance Opening Height could have a variance of 1/16". By changing openings, it may require the door/drawer openings to change.

Door & Drawer Options

AF	CC	CG	GAMD	HC	IFHG	MC	MD	MFO	PRMD ¹	SHMD	SPLITDR	SPLITDRWS
✓	✓	✓	✓	✓	✓	✓	✓	✓	✓	✓	✓	✓

End Panel Options

AUTH	CSFPE	EXBK	EXDN	FL/FR ²	FPE	INTGE	IPE
✓	✓	✓	✓	✓	✓	✓	✓

Custom Modification Options

ADD_SHLF	ADDTK ³	ADRW	ATTK	BVR	CBO	CCO	CFNT0	CFP	CFRMO	CLIP	CND	CSDGBK	DRWTK	EX	EX_OL	FLUT ³	FTK	ID
✓	✓	✓	✓	✓	✓	✓	✓	✓	✓	✓	✓	✓	✓	✓	✓	✓	✓	✓

IH	IW ⁴	MIP	OBRB	PFINBTMB	RD	RECTK ¹	RH ⁵	ROSFLUT ⁶	RT	SCPDWR	TD ¹	TKP ¹	TVR	VTK	WS	WTC	WTKCUP	WTR
✓	✓	✓	✓	✓	✓	✓	✓	✓	✓	✓	✓	✓	✓	✓	✓	✓	✓	✓

¹ Not available on 24" wide.

² Not available on 3639 version.

³ Not available with fluting both or with 6" fluting.

⁴ Not available on 36" wide.

⁵ Only available on 3336 version.

⁶ Not available with fluting both.

IH/RH availability charts starting on page G•40.
IW/RW availability charts starting on page G•46.

WALL BUILT-IN MICROWAVE DOUBLE DOOR CABINET, 36" or 39" HIGH, 18" DEEP

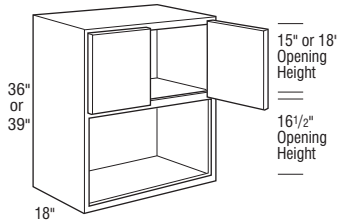

Specify appliance opening dimensions:

WBMW__18AC

Microwave Wall

18" Deep

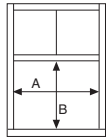

Appliance Opening Dimensions:

A _____
B _____

NOTE:

See chart for specific model appliance opening limitations.

Cabinet appliance openings may vary with modifications (i.e. clipped corner modification reduces maximum cut-out width by 3" per clipped corner).

	Cubic Feet	1	2	3	4	5	6	7
WBMW243618AC	11.6	2363	2452	2524	2640	2765	2978	3191
WBMW273618AC	12.7	2410	2507	2577	2709	2847	3080	3313
WBMW303618AC	14.0	2480	2577	2658	2791	2938	3182	3426
WBMW333618AC	15.3	2610	2715	2797	2938	3083	3340	3597
WBMW363618AC	16.7	2719	2831	2922	3067	3230	3499	3768
WBMW243918AC	12.7	2580	2676	2754	2881	3018	3249	3480
WBMW273918AC	13.7	2626	2727	2810	2951	3100	3357	3614
WBMW303918AC	15.1	2704	2810	2901	3043	3203	3469	3735
WBMW333918AC	16.6	2843	2961	3052	3203	3362	3643	3924
WBMW363918AC	18.0	2963	3084	3185	3346	3520	3817	4114

- Matching Interior standard.
- Specify cut-out size.
- When Beaded Inset is ordered, the cabinet should be ordered to the appropriate width using the 1/4" width modification instead of using the piece-in or cut-out applications.
- The maximum cut-out width is 1 1/2" less than the overall width of the cabinet. The maximum cut-out height varies depending on the cabinet.
- Reduced Depths available in 1/4" increments from 6" to 17 3/4".
- Ordering Maximum Width Cut-out on cabinet will change end panel thickness from 1/2" to 3/8" for non-flush ends, and from 5/8" to 1/2" for flush ends.

	Standard Appliance Opening		Decreased Appliance Opening Width*		Increased Appliance Opening Width**		Appliance Opening Height***	
	Width (A)	Height (B)	Min. Width (A)	Max. Width (A)	Min. Width (A)	Max. Width (A)	Min. Height (B)	Max. Height (B)
WBMW243618AC	21"	16 1/2"	9"	20 1/2"	21 1/16"	22 1/2"	14"	19 1/2"
WBMW273618AC	24"	16 1/2"	12"	23 1/2"	24 1/16"	25 1/2"	14"	19 1/2"
WBMW303618AC	27"	16 1/2"	15"	26 1/2"	27 1/16"	28 1/2"	14"	19 1/2"
WBMW333618AC	30"	16 1/2"	18"	29 1/2"	30 1/16"	31 1/2"	14"	19 1/2"
WBMW363618AC	33"	16 1/2"	21"	32 1/2"	33 1/16"	34 1/2"	14"	19 1/2"
WBMW243918AC	21"	16 1/2"	9"	20 1/2"	21 1/16"	22 1/2"	14"	19 1/2"
WBMW273918AC	24"	16 1/2"	12"	23 1/2"	24 1/16"	25 1/2"	14"	19 1/2"
WBMW303918AC	27"	16 1/2"	15"	26 1/2"	27 1/16"	28 1/2"	14"	19 1/2"
WBMW333918AC	30"	16 1/2"	18"	29 1/2"	30 1/16"	31 1/2"	14"	19 1/2"
WBMW363918AC	33"	16 1/2"	21"	32 1/2"	33 1/16"	34 1/2"	14"	19 1/2"

*Decreased Appliance Opening Width can vary in 1/16" increments by piecing in frame material.

**Increased Appliance Opening Width can vary in 1/16" increments by cutting out the frame stiles.

***Appliance Opening Height could have a variance of 1/16". By changing openings, it may require the door/drawer openings to change.

Door & Drawer Options

AF	CC	CG	GAMD ¹	HC	IFHG	MC	MD	MFO	PRMD ¹	SHMD	SPLITDR	SPLITDRWS
✓	✓	✓	✓	✓	✓	✓	✓	✓	✓	✓	✓	✓

End Panel Options

AUTH	CSFPE ²	EXBK	EXDN	FL/FR	FPE	INTGE ²	IPE ²
✓	✓	✓	✓	✓	✓	✓	✓

Custom Modification Options

ADD	SHLF	ADTK	ADRW	ATTK	BVR	CBO	CCO	CFNTO	CFP	CFRMO	CLIP	CND	CSDGBK	DRWTK	EX	EX_OL	FLUT ³	FTK	ID
✓	✓	✓	✓	✓	✓	✓	✓	✓	✓	✓	✓	✓	✓	✓	✓	✓	✓	✓	✓

IH	IW ⁴	MIP	OBRB	PFINBTMB	RD	RECTK	RH	ROSLUT	RT	SCPDRW	TD ¹	TKP	TVR	VTK	WS	WTCD	WTKCUP	WTR
✓	✓	✓	✓	✓	✓	✓	✓	✓	✓	✓	✓	✓	✓	✓	✓	✓	✓	✓

¹ Not available on 24" wide.

² Not available when cut-out width is greater than standard.

³ Not available with 6" fluting.

⁴ Not available on 36" wide.

Wall Microwave Cabinets

WALL MICROWAVE DOUBLE DOOR CABINET, 42", 45", or 48" HIGH

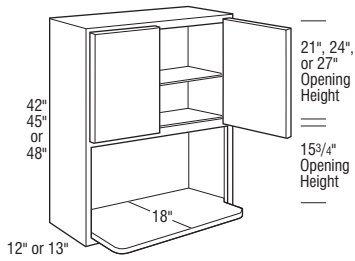

Specify appliance opening dimensions:

MW _____
Microwave Wall
with Shelf

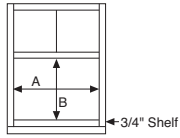

Appliance Opening Dimensions:

A _____
B _____

NOTE:

See chart for specific model appliance opening limitations.

Cabinet appliance openings may vary with modifications (i.e. clipped corner modification reduces maximum cut-out width by 3" per clipped corner).

	Cubic Feet	1	2	3	4	5	6	7
MW2442	9.3	2763	2865	2951	3087	3232	3481	3730
MW2742	10.4	2859	2975	3057	3203	3357	3629	3901
MW3042	11.5	2938	3052	3144	3299	3460	3739	4018
MW3342	12.6	3020	3132	3224	3373	3532	3802	4072
MW3642	13.7	3105	3221	3315	3468	3631	3911	4191
MW2445	9.9	2946	3056	3146	3291	3447	3711	3975
MW2745	11.1	3050	3171	3260	3419	3581	3874	4167
MW3045	12.3	3136	3256	3357	3521	3693	3991	4289
MW3345	13.5	3223	3341	3441	3599	3769	4058	4347
MW3645	14.6	3314	3436	3538	3700	3875	4174	4473
MW2448	10.6	3037	3150	3244	3394	3554	3827	4100
MW2748	11.8	3130	3256	3351	3506	3670	3973	4276
MW3048	13.1	3212	3339	3447	3615	3786	4096	4406
MW3348	14.3	3291	3414	3516	3676	3850	4144	4438
MW3648	15.6	3373	3497	3601	3768	3945	4248	4551

- Matching Interior standard.
- Specify cut-out size.
- When Beaded Inset is ordered, the cabinet should be ordered to the appropriate width using the 1/4" width modification instead of using the piece-in or cut-out applications.
- The maximum cut-out width is 2" less than the overall width of the cabinet. The maximum cut-out height varies depending on the cabinet.
- 48" high has two adjustable shelves. Varies with modifications.
- Shelf shipped unattached.
- Microwave shelf depth may be decreased; specify depth required.
- Microwave shelf is solid wood.
- Inset and Beaded Inset Door Styles are a standard 13" deep.
- Full Overlay Styles:
 - Reduced Depths available in 1/4" increments from 6" to 11 3/4".
- Inset and Beaded Inset Styles:
 - Reduced Depths available in 1/4" increments from 6" to 12 3/4".

	Standard Appliance Opening		Decreased Appliance Opening Width*		Increased Appliance Opening Width**		Appliance Opening Height***	
	Width (A)	Height (B)	Min. Width (A)	Max. Width (A)	Min. Width (A)	Max. Width (A)	Min. Height (B)	Max. Height (B)
MW2442	21"	15 3/4"	9"	20 1/2"	21 1/16"	22"	14"	18 3/4"
MW2742	24"	15 3/4"	12"	23 1/2"	24 1/16"	25"	14"	18 3/4"
MW3042	27"	15 3/4"	15"	26 1/2"	27 1/16"	28"	14"	18 3/4"
MW3342	30"	15 3/4"	18"	29 1/2"	30 1/16"	31"	14"	18 3/4"
MW3642	33"	15 3/4"	21"	32 1/2"	33 1/16"	34"	14"	18 3/4"
MW2445	21"	15 3/4"	9"	20 1/2"	21 1/16"	22"	14"	18 3/4"
MW2745	24"	15 3/4"	12"	23 1/2"	24 1/16"	25"	14"	18 3/4"
MW3045	27"	15 3/4"	15"	26 1/2"	27 1/16"	28"	14"	18 3/4"
MW3345	30"	15 3/4"	18"	29 1/2"	30 1/16"	31"	14"	18 3/4"
MW3645	33"	15 3/4"	21"	32 1/2"	33 1/16"	34"	14"	18 3/4"
MW2448	21"	15 3/4"	9"	20 1/2"	21 1/16"	22"	14"	18 3/4"
MW2748	24"	15 3/4"	12"	23 1/2"	24 1/16"	25"	14"	18 3/4"
MW3048	27"	15 3/4"	15"	26 1/2"	27 1/16"	28"	14"	18 3/4"
MW3348	30"	15 3/4"	18"	29 1/2"	30 1/16"	31"	14"	18 3/4"
MW3648	33"	15 3/4"	21"	32 1/2"	33 1/16"	34"	14"	18 3/4"

*Decreased Appliance Opening Width can vary in 1/16" increments by piecing in frame material.

**Increased Appliance Opening Width can vary in 1/16" increments by cutting out the frame stiles.

***Appliance Opening Height could have a variance of 1/16". By changing openings, it may require the door/drawer openings to change.

Door & Drawer Options

AF	CC	CG	GAMD	HC	IFHG	MC	MD	MFO	PRMD	SHMD	SPLITDR	SPLITDRWS
✓	✓	✓	✓	✓	✓	✓	✓	✓	✓	✓	✓	✓

End Panel Options

AUTH	CSFPE	EXBK	EXDN	FL/FR	FPE	INTGE	IPE
✓	✓	✓	✓	✓	✓	✓	✓

Custom Modification Options

ADD_SHLF	ADDTK ²	ADRW	ATTK	BVR	CBO	CCO	CFNT0	CFP	CFRMO	CLIP	CND	CSDGBK	DRWTK	EX	EX_QL	FLUT ³	FTK	ID	
✓	✓	✓	✓	✓	✓	✓	✓	✓	✓	✓	✓	✓	✓	✓	✓	✓	✓	✓	✓

IH	IW ⁴	MIP	OBRB	PFINBTMB	RD	RECTK ²	RH ⁵	ROSFLUT ⁶	RT	SCPDRW	TD ¹	TKP ²	TVR	VTK	WS	WTCD	WTKCUP	WTR	
✓	✓	✓	✓	✓	✓	✓	✓	✓	✓	✓	✓	✓	✓	✓	✓	✓	✓	✓	✓

¹ Not available on 24" wide.

² Only available on 27" and 30" wide.

³ Not available with fluting both or with 6" fluting.

⁴ Not available on 36" wide.

⁵ Only available on 33" wide.

⁶ Not available with fluting both.

IH/RH availability charts starting on page G-40.
IW/RW availability charts starting on page G-46.

WALL BUILT-IN MICROWAVE DOUBLE DOOR CABINET, 36", 39", or 42" HIGH, 18" or 21" DEEP

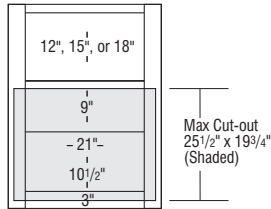
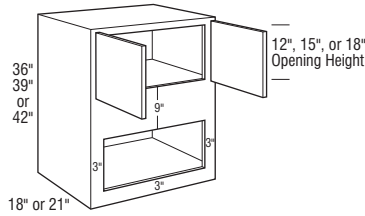

WBMW273618, WBMW273918, WBMW274218
WBMW273621, WBMW273921, WBMW274221

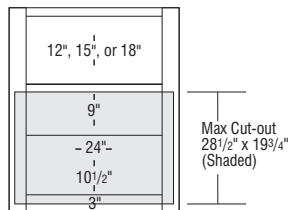

WBMW303618, WBMW303918, WBMW304218
WBMW303621, WBMW303921, WBMW304221

	Cubic Feet	1	2	3	4	5	6	7
WBMW273618	13.7	2281	2366	2436	2548	2668	2875	3082
WBMW303618	15.0	2369	2457	2530	2646	2771	2986	3201
WBMW273621	11.8	2372	2460	2534	2649	2774	2990	3206
WBMW303621	13.1	2464	2555	2631	2752	2882	3105	3328
WBMW273918	13.5	2497	2589	2666	2789	2920	3146	3372
WBMW303918	14.9	2598	2694	2774	2901	3038	3274	3510
WBMW273921	12.8	2598	2694	2774	2901	3038	3274	3510
WBMW303921	14.2	2701	2801	2885	3017	3159	3404	3649
WBMW274218	15.8	2725	2826	2910	3043	3187	3434	3681
WBMW304218	17.4	2835	2940	3028	3166	3316	3573	3830
WBMW274221	13.8	2826	2930	3018	3156	3305	3561	3817
WBMW304221	17.4	2939	3047	3138	3282	3437	3703	3969

- Matching Interior standard.
- 42" high includes one adjustable shelf.
- See chart for specific model appliance opening limitations.
- Designed for built-in microwaves.
- Increased Depths available in 1/4" increments from 18 1/4" to 30".
- Reduced Depths available in 1/4" increments from 6" to 17 3/4".

	Factory Opening		Maximum Cut-out	
	Width	Height	Width	Height
WBMW273618	21"	10 1/2"	25 1/2"	19 3/4"
WBMW303618	24"	10 1/2"	28 1/2"	19 3/4"
WBMW273621	21"	10 1/2"	25 1/2"	19 3/4"
WBMW303621	24"	10 1/2"	28 1/2"	19 3/4"
WBMW273918	21"	10 1/2"	25 1/2"	19 3/4"
WBMW303918	24"	10 1/2"	28 1/2"	19 3/4"
WBMW273921	21"	10 1/2"	25 1/2"	19 3/4"
WBMW303921	24"	10 1/2"	28 1/2"	19 3/4"
WBMW274218	21"	10 1/2"	25 1/2"	19 3/4"
WBMW304218	24"	10 1/2"	28 1/2"	19 3/4"
WBMW274221	21"	10 1/2"	25 1/2"	19 3/4"
WBMW304221	24"	10 1/2"	28 1/2"	19 3/4"

Door & Drawer Options

AF	CC	CG	GAMD ¹	HC	IFHG	MC	MD	MFO	PRMD ¹	SHMD	SPLITDR	SPLITDRWS
✓	✓	✓	✓	✓	✓	✓	✓	✓	✓	✓	✓	✓

End Panel Options

AUTH	CSFPE	EXBK	EXDN	FL/FR	FPE	INTGE	IPE
✓	✓	✓	✓	✓	✓	✓	✓

Custom Modification Options

ADD_SHLF	ADDTK	ADRW	ATTK	BVR	CBO	CCO	CFNTO	CFP	CFRMO	CLIP	CND	CSDGBK	DRWTK	EX	EX_OL	FLUT ²	FTK	ID
✓	✓	✓	✓	✓	✓	✓	✓	✓	✓	✓	✓	✓	✓	✓	✓	✓	✓	✓

IH	IW ³	MIP	OBRB	PFINBTMB	RD	RECTK	RH	ROSLUT	RT	SCPDRW	TD ¹	TKP	TVR	VTK	WS	WTCD	WTKCUP	WTR
✓	✓	✓	✓	✓	✓	✓	✓	✓	✓	✓	✓	✓	✓	✓	✓	✓	✓	✓

¹ Not available on 24" wide.

² Not available with 6" fluting.

³ Not available on 36" wide.

Wall Microwave Cabinets

WALL BUILT-IN MICROWAVE DOUBLE DOOR CABINET, 42", 45", or 48" HIGH, 18" DEEP

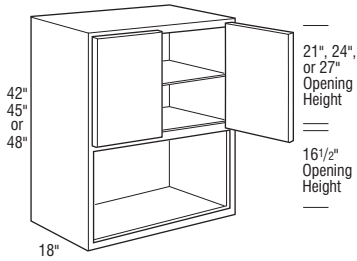

Specify appliance opening dimensions:

WBMW _ _ **18**
Microwave Wall
18" Deep

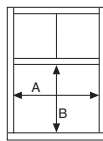

Appliance Opening Dimensions:

A _____
B _____

NOTE:

See chart for specific model appliance opening limitations.

Cabinet appliance openings may vary with modifications (i.e. clipped corner modification reduces maximum cut-out width by 3" per clipped corner).

	Cubic Feet	1	2	3	4	5	6	7
WBMW244218AC	13.8	2678	2777	2859	2991	3131	3372	3613
WBMW274218AC	14.7	2724	2839	2922	3067	3224	3494	3764
WBMW304218AC	16.3	2804	2917	3009	3166	3325	3607	3889
WBMW334218AC	17.5	2890	2997	3087	3228	3382	3640	3898
WBMW364218AC	18.7	2978	3088	3180	3326	3483	3750	4017
WBMW244518AC	14.9	2866	2975	3062	3203	3355	3611	3867
WBMW274518AC	15.7	2914	3036	3127	3286	3447	3737	4027
WBMW304518AC	17.4	2999	3122	3224	3385	3560	3859	4158
WBMW334518AC	19.9	3089	3205	3298	3451	3615	3891	4167
WBMW364518AC	21.1	3180	3297	3395	3552	3720	4004	4288
WBMW244818AC	16.0	2932	3041	3131	3276	3430	3693	3956
WBMW274818AC	16.7	2995	3122	3214	3374	3537	3838	4139
WBMW304818AC	18.5	3079	3207	3315	3478	3654	3964	4274
WBMW334818AC	22.3	3159	3277	3373	3528	3695	3978	4261
WBMW364818AC	23.5	3244	3365	3464	3624	3795	4087	4379

- Matching Interior standard.
- Specify cut-out size.
- When Beaded Inset is ordered, the cabinet should be ordered to the appropriate width using the 1/4" width modification instead of using the piece-in or cut-out applications.
- The maximum cut-out height varies less than the overall width of the cabinet. The maximum cut-out height varies depending on the cabinet.
- 48" high has two adjustable shelves. Varies with modifications.
- Reduced Depths available in 1/4" increments from 6" to 17 3/4".
- Ordering Maximum Width Cut-out on cabinet will change end panel thickness from 1/2" to 3/8" for non-flush ends, and from 5/8" to 1/2" for flush ends.

	Standard Appliance Opening		Decreased Appliance Opening Width*		Increased Appliance Opening Width**		Appliance Opening Height***	
	Width (A)	Height (B)	Min. Width (A)	Max. Width (A)	Min. Width (A)	Max. Width (A)	Min. Height (B)	Max. Height (B)
WBMW244218AC	21"	16 1/2"	9"	20 1/2"	21 1/16"	22 1/2"	14"	19 1/2"
WBMW274218AC	24"	16 1/2"	12"	23 1/2"	24 1/16"	25 1/2"	14"	19 1/2"
WBMW304218AC	27"	16 1/2"	15"	26 1/2"	27 1/16"	28 1/2"	14"	19 1/2"
WBMW334218AC	30"	16 1/2"	18"	29 1/2"	30 1/16"	31 1/2"	14"	19 1/2"
WBMW364218AC	33"	16 1/2"	21"	32 1/2"	33 1/16"	34 1/2"	14"	19 1/2"
WBMW244518AC	21"	16 1/2"	9"	20 1/2"	21 1/16"	22 1/2"	14"	19 1/2"
WBMW274518AC	24"	16 1/2"	12"	23 1/2"	24 1/16"	25 1/2"	14"	19 1/2"
WBMW304518AC	27"	16 1/2"	15"	26 1/2"	27 1/16"	28 1/2"	14"	19 1/2"
WBMW334518AC	30"	16 1/2"	18"	29 1/2"	30 1/16"	31 1/2"	14"	19 1/2"
WBMW364518AC	33"	16 1/2"	21"	32 1/2"	33 1/16"	34 1/2"	14"	19 1/2"
WBMW244818AC	21"	16 1/2"	9"	20 1/2"	21 1/16"	22 1/2"	14"	19 1/2"
WBMW274818AC	24"	16 1/2"	12"	23 1/2"	24 1/16"	25 1/2"	14"	19 1/2"
WBMW304818AC	27"	16 1/2"	15"	26 1/2"	27 1/16"	28 1/2"	14"	19 1/2"
WBMW334818AC	30"	16 1/2"	18"	29 1/2"	30 1/16"	31 1/2"	14"	19 1/2"
WBMW364818AC	33"	16 1/2"	21"	32 1/2"	33 1/16"	34 1/2"	14"	19 1/2"

*Decreased Appliance Opening Width can vary in 1/16" increments by piecing in frame material.

**Increased Appliance Opening Width can vary in 1/16" increments by cutting out the frame stiles.

***Appliance Opening Height could have a variance of 1/16". By changing openings, it may require the door/drawer openings to change.

Door & Drawer Options

AF	CC	CG	GAMD ¹	HC	IFHG	MC	MD	MFO	PRMD ²	SHMD	SPLITDR	SPLITDRWS
✓	✓	✓	✓	✓	✓	✓	✓	✓	✓	✓	✓	✓

End Panel Options

AUTH	CSFPE ³	EXBK	EXDN	FL/FR	FPE	INTGE ³	IPE ³
✓	✓	✓	✓	✓	✓	✓	✓

Custom Modification Options

ADD	SHLF	ADTK	ADRW	ATTK	BVR	CBO	CCO	CFNT0	CFP	CFRMO	CLIP	CND	CSDGBK	DRWTK	EX	EX_OL	FLUT ⁴	FTK	ID	
✓	✓	✓	✓	✓	✓	✓	✓	✓	✓	✓	✓	✓	✓	✓	✓	✓	✓	✓	✓	✓

IH	IW ⁵	IMP	OBRB	PFINBTMB	RD	RECTK	RH	ROSLUT	RT	SCPDRW	TD ²	TKP	TVR	VTK	WS	WTCD	WTKCUP	WTR	
✓	✓	✓	✓	✓	✓	✓	✓	✓	✓	✓	✓	✓	✓	✓	✓	✓	✓	✓	✓

¹ Only available on 27" and 30" wide.

² Not available on 24" wide.

³ Not available when cut-out width is greater than standard.

⁴ Not available with 6" fluting.

⁵ Not available on 36" wide.

IH/RH availability charts starting on page G•40.
IW/RW availability charts starting on page G•46.

Three Drawer Base Cabinets

THREE DRAWER BASE, WARMING DRAWER, 34 1/2" HIGH, 24" DEEP

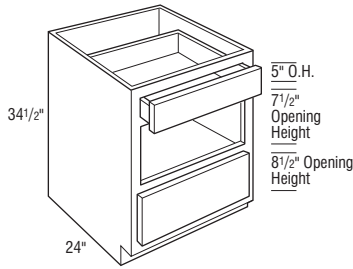

Specify appliance opening dimensions:

3DB _ _ WD

3 Drawer Base, Warming Drawer

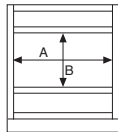

Appliance Opening Dimensions:

A _____
B _____

NOTE:

See chart for specific model appliance opening limitations.

Cabinet appliance openings may vary with modifications (i.e. clipped corner modification reduces maximum cut-out width by 3" per clipped corner).

	Cubic Feet	1	2	3	4	5	6	7
3DB24WD	14.1	1835	1926	1988	2096	2225	2432	2639
3DB27WD	15.7	2323	2437	2517	2649	2805	3067	3329
3DB30WD	17.4	2553	2672	2769	2917	3093	3382	3671
3DB33WD	19.0	2781	2885	2970	3109	3255	3502	3749
3DB36WD	20.7	3002	3114	3206	3355	3512	3782	4052

- When Beaded Inset is ordered, the cabinet should be ordered to the appropriate width using the 1/4" width modification instead of using the piece-in or cut-out applications.
- Reduced Depths available in 1/4" increments from 12" to 23 3/4".
- Ordering Maximum Width Cut-out on cabinet will change end panel thickness from 1/2" to 3/8" for non-flush ends, and from 5/8" to 1/2" for flush ends.

	Standard Appliance Opening		Decreased Appliance Opening Width*		Increased Appliance Opening Width**		Appliance Opening Height***	
	Width (A)	Height (B)	Min. Width (A)	Max. Width (A)	Min. Width (A)	Max. Width (A)	Min. Height (B)	Max. Height (B)
3DB24WD	21"	7 1/2"	9"	20 1/2"	21 1/16"	22 1/2"	7 1/2"	10 1/2"
3DB27WD	24"	7 1/2"	12"	23 1/2"	24 1/16"	25 1/2"	7 1/2"	10 1/2"
3DB30WD	27"	7 1/2"	15"	26 1/2"	27 1/16"	28 1/2"	7 1/2"	10 1/2"
3DB33WD	30"	7 1/2"	18"	29 1/2"	30 1/16"	31 1/2"	7 1/2"	10 1/2"
3DB36WD	33"	7 1/2"	21"	32 1/2"	33 1/16"	34 1/2"	7 1/2"	10 1/2"

*Decreased Appliance Opening Width can vary in 1/16" increments by piecing in frame material.

**Increased Appliance Opening Width can vary in 1/16" increments by cutting out the frame stiles.

***Appliance Opening Height could have a variance of 1/16". By changing openings, it may require the door/drawer openings to change.

Door & Drawer Options

AF	CC	CG	GAMD	HC	IFHG	MC	MD	MFO	PRMD	SHMD	SPLITDR	SPLITDRWS
												✓

End Panel Options

AUTH	CSFPE ¹	EXBK	EXDN	FL/FR	FPE	INTGE ¹	IFE ¹
✓	✓	✓	✓	✓	✓	✓	✓

Custom Modification Options

ADD_SHLF	ADDTK	ADRW	ATTK	BVR	CBO	CCO	CFNT0	CFP	CFRMO	CLIP	CND	CSDGBK	DRWTK ²	EX	EX_QL	FLUT	FTK	ID	
					✓	✓	✓	✓	✓	✓	✓	✓	✓	✓	✓	✓	✓	✓	✓

IH	IW ³	MIP	OBRB	PFINBTMB	RD	RECTK ⁴	RH	ROSFLUT	RT	SCPDRW	TD	TKP ⁴	TVR ⁵	VTK ⁴	WS	WTC ⁶	WTKCUP	WTR	
✓	✓	✓	✓	✓	✓	✓	✓	✓	✓	✓	✓	✓	✓	✓	✓	✓	✓	✓	✓

¹ Not available when cut-out width is greater than standard.

² Only available on 27" and 30" wide.

³ Not available on 36" wide.

⁴ Not available on 33" or 36" wide.

⁵ Not available on 24" or 27" wide. Not available on 27" or 33" wide.

Base Microwave Cabinets

BASE MICROWAVE CABINET with ROLL TRAY(S), 34 1/2" or 40 1/2" HIGH, 24" DEEP

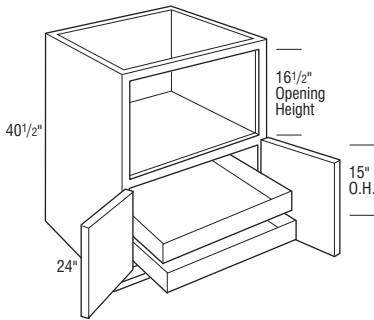
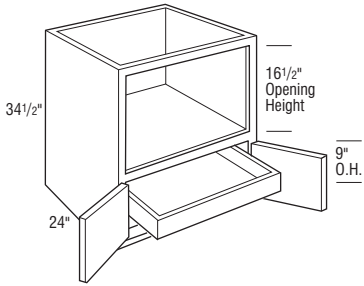

Specify appliance opening dimensions:

BMW __
Base Microwave with Drawer

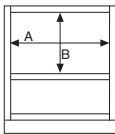

Appliance Opening Dimensions:

A _____
B _____

NOTE:

See chart for specific model appliance opening limitations.

Cabinet appliance openings may vary with modifications (i.e. clipped corner modification reduces maximum cut-out width by 3" per clipped corner).

	Cubic Feet	1	2	3	4	5	6	7
BMW24RT	14.1	2341	2428	2501	2617	2740	2949	3158
BMW27RT	15.7	2378	2491	2578	2720	2882	3146	3410
BMW30RT	17.4	2423	2544	2630	2774	2940	3211	3482
BMW33RT	19.0	2481	2574	2651	2773	2903	3126	3349
BMW36RT	20.7	2533	2628	2706	2829	2963	3191	3419

• Includes one roll-out tray.

BMW2440RT	16.3	2918	3026	3116	3260	3414	3675	3936
BMW2740RT	18.4	2961	3100	3212	3385	3588	3918	4248
BMW3040RT	20.3	3003	3148	3260	3438	3640	3978	4316
BMW3340RT	22.0	3056	3169	3262	3414	3574	3848	4122
BMW3640RT	23.9	3100	3217	3313	3465	3628	3906	4184

• Includes two roll-out trays.

Notes below apply to all products in section above:

- Matching Interior standard.
- Specify cut-out or use standard cut-out.
- When Beaded Inset is ordered, the cabinet should be ordered to the appropriate width using the 1/4" width modification instead of using the piece-in or cut-out applications.
- The maximum cut-out width is 1 1/2" less than the overall width of the cabinet.
- Reduced Depths available in 1/4" increments from 12" to 23 3/4".
- Ordering Maximum Width Cut-out on cabinet will change end panel thickness from 1/2" to 3/8" for non-flush ends, and from 5/8" to 1/2" for flush ends.

	Standard Appliance Opening		Decreased Appliance Opening Width*		Increased Appliance Opening Width**		Appliance Opening Height***	
	Width (A)	Height (B)	Min. Width (A)	Max. Width (A)	Min. Width (A)	Max. Width (A)	Min. Height (B)	Max. Height (B)
BMW24RT	21"	16 1/2"	9"	20 1/2"	21 1/16"	22 1/2"	11 1/2"	16 1/2"
BMW27RT	24"	16 1/2"	12"	23 1/2"	24 1/16"	25 1/2"	11 1/2"	16 1/2"
BMW30RT	27"	16 1/2"	15"	26 1/2"	27 1/16"	28 1/2"	11 1/2"	16 1/2"
BMW33RT	30"	16 1/2"	18"	29 1/2"	30 1/16"	31 1/2"	11 1/2"	16 1/2"
BMW36RT	33"	16 1/2"	21"	32 1/2"	33 1/16"	34 1/2"	11 1/2"	16 1/2"
BMW2440RT	21"	16 1/2"	9"	20 1/2"	21 1/16"	22 1/2"	11 1/2"	19 1/2"
BMW2740RT	24"	16 1/2"	12"	23 1/2"	24 1/16"	25 1/2"	11 1/2"	19 1/2"
BMW3040RT	27"	16 1/2"	15"	26 1/2"	27 1/16"	28 1/2"	11 1/2"	19 1/2"
BMW3340RT	30"	16 1/2"	18"	29 1/2"	30 1/16"	31 1/2"	11 1/2"	19 1/2"
BMW3640RT	33"	16 1/2"	21"	32 1/2"	33 1/16"	34 1/2"	11 1/2"	19 1/2"

*Decreased Appliance Opening Width can vary in 1/16" increments by piecing in frame material.

**Increased Appliance Opening Width can vary in 1/16" increments by cutting out the frame stiles.

***Appliance Opening Height could have a variance of 1/16". By changing openings, it may require the door/drawer openings to change.

Door & Drawer Options

AF	CC	CG ¹	GAMD ²	HC	IFHG	JMC	MD ¹	MFO	PRMD ³	SHMD	SPLITDR	SPLITDRWS
		✓	✓		✓		✓		✓			

End Panel Options

AUTH	CSFPE ⁴	EXBK ⁵	EXDN	FL/FR	FPE	INTGE ⁴	IPE ⁴
✓	✓	✓		✓	✓	✓	✓

Custom Modification Options

ADD	SHLF	ADDTK	ADRW	ATTK	BVR	CBO ⁵	CCO	CFNT ⁵	CFP	CFRMO ⁵	CLIP	CND ⁵	CSDGBK	DRWTK ⁶	EX	EX_OL	FLUT ⁷	FTK	ID	
						✓		✓		✓	✓	✓	✓	✓	✓	✓	✓	✓	✓	✓

IH	IW ⁸	JMP	OBRB ⁵	PFINBTMB	RD	RECTK ⁹	RH	ROSLUT	RT	SCPRW	TD	TKP ⁹	TVR	VTK ⁹	WS	WTCD	WTKCUP	WTR	
✓	✓	✓	✓	✓	✓	✓	✓	✓	✓	✓	✓	✓	✓	✓	✓	✓	✓	✓	✓

¹ Only available on 40.5" high.

² Not available on 24" or 27" wide.

³ Only available on the 40.5" high except on the 24" and 27" wide.

⁴ Not available when cut-out width is greater than standard.

⁵ Not available on 24" or 27" wide on the 34.5" high. Not available on 27" wide on the 40.5" high.

⁶ Only available on the 30" wide on the 34.5" high.

⁷ 6" fluting not available on 24" or 27" wide. Not available with 6" fluting both.

⁸ Not available on 36" wide.

⁹ Only available on 27" and 30" wide.

IH/RH availability charts starting on page G•40.
IW/RW availability charts starting on page G•46.

BASE MICROWAVE CABINET with DRAWER, 34 1/2" HIGH, 24" DEEP

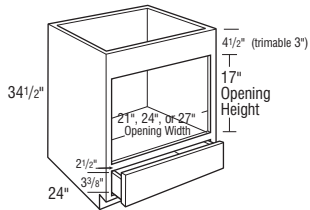

Specify appliance opening dimensions:

BMWD _ _
Base Microwave with Drawer

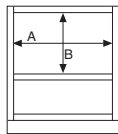

Appliance Opening Dimensions:

A _____
B _____

NOTE:

See chart for specific model appliance opening limitations.

Cabinet appliance openings may vary with modifications (i.e. clipped corner modification reduces maximum cut-out width by 3" per clipped corner).

	Cubic Feet	1	2	3	4	5	6	7
BMWD24	14.1	2267	2375	2459	2595	2747	3001	3255
BMWD27	16.1	2361	2474	2561	2703	2861	3125	3389
BMWD30	17.4	3023	3168	3280	3461	3664	4002	4340

- Matching Interior standard.
- The usable cabinet face height between top of drawer front and top of cabinet is 23 1/2". Be sure to verify overall appliance height, gap requirements, and cut-out dimensions with cabinet specifications.
- Includes one drawer.
- Reduced Depths available in 1/4" increments from 12" to 23 3/4".

Model	Opening Width (A)	Maximum Width (A)	Opening Height (B)	Maximum Height (B)
BMWD24	21"	22 1/2"	17"	20"
BMWD27	24"	25 1/2"	17"	20"
BMWD30	27"	28 1/2"	17"	20"

Door & Drawer Options

AF	CC	CG	GAMD	HC	IFHG	MC	MD	MFO	PRMD	SHMD	SPLITDR	SPLITDRWS
----	----	----	------	----	------	----	----	-----	------	------	---------	-----------

End Panel Options

AUTH	CSFPE	EXBK	EXDN	FL/FR	FPE	INTGE	IPE
✓	✓	✓	✓	✓	✓	✓	✓

Custom Modification Options

ADD	SHLF	ADDTK	ADRW	ATTK	BVR	CBO	CCO	CFNTO	CFP	CFRMO	CLIP	CND	CSDGBK	DRWTK ¹	EX	EX_OL	FLUT ²	FTK	ID

IH	IW ³	MIP	OBRB	PFINBTMB	RD	RECTK ⁴	RH	ROSFLUT	RT	SCPDRW	TD	TKP ⁴	TVR	VTK ⁴	WS	WTCD	WTKCUP	WTR	
✓	✓	✓	✓	✓	✓	✓	✓	✓	✓	✓	✓	✓	✓	✓	✓	✓	✓	✓	✓

¹ Only available on 24" and 30" wide.

² 6" fluting not available on 24" or 27" wide. Not available with 6" fluting both.

³ Not available on 36" wide.

⁴ Not available on 33" or 36" wide.

BASE BUILT-IN MICROWAVE CABINET with DRAWER, 34 1/2" HIGH, 24" DEEP

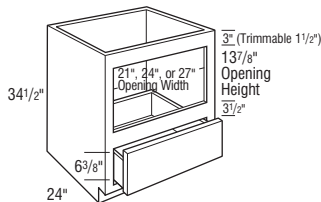

Specify appliance opening dimensions:

BBMWD _ _
Base Microwave with Drawer

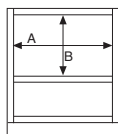

Appliance Opening Dimensions:

A _____
B _____

NOTE:

See chart for specific model appliance opening limitations.

Cabinet appliance openings may vary with modifications (i.e. clipped corner modification reduces maximum cut-out width by 3" per clipped corner).

	14.1	2391	2506	2594	2738	2898	3165	3432
BBMWD24	14.1	2391	2506	2594	2738	2898	3165	3432
BBMWD27	16.1	2849	2986	3091	3262	3454	3772	4090
BBMWD30	17.4	2873	3010	3117	3289	3482	3803	4124

- Matching Interior standard.
- The usable cabinet face height between top of drawer front and top of cabinet is 19 3/4". Be sure to verify overall appliance height, gap requirements, and cut-out dimensions with cabinet specifications.
- Includes one drawer.
- Reduced Depths available in 1/4" increments from 12" to 23 3/4".
- For built-in appliance support, OCINSTALLKIT is included in 24" deep cabinets, but will not be included when depth is modified.

Model	Opening Width (A)	Maximum Width (A)	Opening Height (B)	Maximum Height (B)
BBMWD24	21"	22 1/2"	13 7/8"	16 7/8"
BBMWD27	24"	25 1/2"	13 7/8"	16 7/8"
BBMWD30	27"	28 1/2"	13 7/8"	16 7/8"

Door & Drawer Options

AF	CC	CG	GAMD	HC	IFHG	MC	MD	MFO	PRMD	SHMD	SPLITDR	SPLITDRWS
----	----	----	------	----	------	----	----	-----	------	------	---------	-----------

End Panel Options

AUTH	CSFPE	EXBK	EXDN	FL/FR	FPE	INTGE	IPE
✓	✓	✓	✓	✓	✓	✓	✓

Custom Modification Options

ADD	SHLF	ADDTK	ADRW	ATTK	BVR	CBO	CCO	CFNTO	CFP	CFRMO	CLIP	CND	CSDGBK	DRWTK ¹	EX	EX_OL	FLUT ²	FTK	ID

IH	IW ³	MIP	OBRB	PFINBTMB	RD	RECTK ⁴	RH	ROSFLUT	RT	SCPDRW	TD	TKP ⁴	TVR	VTK ⁴	WS	WTCD	WTKCUP	WTR	
✓	✓	✓	✓	✓	✓	✓	✓	✓	✓	✓	✓	✓	✓	✓	✓	✓	✓	✓	✓

¹ Only available on 24" and 30" wide.

² 6" fluting not available on 24" or 27" wide. Not available with 6" fluting both.

³ Not available on 36" wide.

⁴ Not available on 33" or 36" wide.

Base Microwave & Base Oven Cabinets

BASE MICROWAVE CABINET with DEEP DRAWER, 34 1/2" HIGH, 24" DEEP

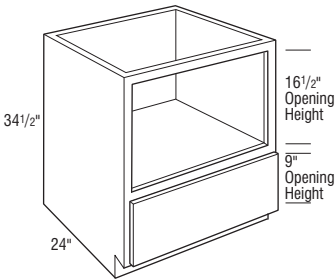

Specify appliance opening dimensions:

BMWD _ _ DD

Base Microwave with Drawer

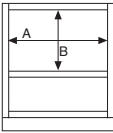

Appliance Opening Dimensions:

A _____
B _____

NOTE:

See chart for specific model appliance opening limitations.

Cabinet appliance openings may vary with modifications (i.e. clipped corner modification reduces maximum cut-out width by 3" per clipped corner).

	Cubic Feet	1	2	3	4	5	6	7
BMWD24DD	13.9	2232	2339	2422	2559	2699	2940	3181
BMWD27DD	15.7	2272	2380	2465	2599	2753	3005	3257
BMWD30DD	17.4	2320	2431	2517	2656	2812	3071	3330
BMWD33DD	19.0	2367	2455	2528	2645	2769	2982	3195
BMWD36DD	20.7	2415	2505	2578	2695	2824	3041	3258

- Matching Interior standard.
- If opening height increases, drawer opening decreases to 6 1/2" or 4 1/2".
- Reduced Depths available in 1/4" increments from 12" to 23 3/4".
- When Beaded Inset is ordered, the cabinet should be ordered to the appropriate width using the 1/4" width modification instead of using the piece-in or cut-out applications.
- Ordering Maximum Width Cut-out on cabinet will change end panel thickness from 1/2" to 3/8" for non-flush ends, and from 5/8" to 1/2" for flush ends.

	Standard Appliance Opening		Decreased Appliance Opening Width*		Increased Appliance Opening Width**		Appliance Opening Height***	
	Width (A)	Height (B)	Min. Width (A)	Max. Width (A)	Min. Width (A)	Max. Width (A)	Min. Height (B)	Max. Height (B)
BMWD24DD	21"	16 1/2"	9"	20 1/2"	21 1/16"	22 1/2"	11 1/2"	21"
BMWD27DD	24"	16 1/2"	12"	23 1/2"	24 1/16"	25 1/2"	11 1/2"	21"
BMWD30DD	27"	16 1/2"	15"	26 1/2"	27 1/16"	28 1/2"	11 1/2"	21"
BMWD33DD	30"	16 1/2"	18"	29 1/2"	30 1/16"	31 1/2"	11 1/2"	21"
BMWD36DD	33"	16 1/2"	21"	32 1/2"	33 1/16"	34 1/2"	11 1/2"	21"

*Decreased Appliance Opening Width can vary in 1/16" increments by piecing in frame material.

**Increased Appliance Opening Width can vary in 1/16" increments by cutting out the frame stiles.

***Appliance Opening Height could have a variance of 1/16". By changing openings, it may require the door/drawer openings to change.

Door & Drawer Options

AF	CC	CG	GAMD	HC	IFHG	MC	MD	MFO	PRMD	SHMD	SPLITDR	SPLITDRWS
----	----	----	------	----	------	----	----	-----	------	------	---------	-----------

End Panel Options

AUTH	CSFPE ¹	EXBK	EXDN	FL/FR	FPE	INTGE ¹	IPE ¹
✓	✓	✓	✓	✓	✓	✓	✓

Custom Modification Options

ADD	SHLF	ADTK	ADRW	ATTK	BVR	CBO	CCO	CFNTD	CFP	CFRMO	CLIP	CND	CSDGBK	DRWTK ²	EX	EX_OL	FLUT ³	FTK	ID
✓	✓	✓	✓	✓	✓	✓	✓	✓	✓	✓	✓	✓	✓	✓	✓	✓	✓	✓	✓

IH	IW ⁴	MIP	OBRB	PFINBTMB	RD	RECTK ⁵	RH	ROSFLUT	RT	SCPDWR	TD	TKP ⁵	TVR	VTK ⁵	WS	WTCD	WTKCUP	WTR
✓	✓	✓	✓	✓	✓	✓	✓	✓	✓	✓	✓	✓	✓	✓	✓	✓	✓	✓

¹ Not available when cut-out width is greater than standard.

² Only available on 24" and 30" wide.

³ 6" fluting not available on 24" or 27" wide. Not available with 6" fluting both.

⁴ Not available on 36" wide.

⁵ Not available on 33" or 36" wide.

BASE OVEN TRIMMABLE CABINET, 34 1/2" HIGH, 24" DEEP

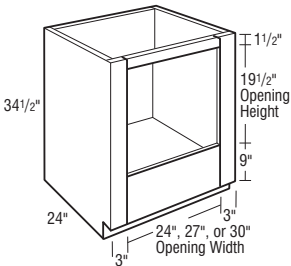

	15.6	1650	1650	1650	1650	1650	1650	1650
B027	15.6	1650	1650	1650	1650	1650	1650	1650
B030	17.7	1701	1701	1701	1701	1701	1701	1701
B033	19.6	1766	1766	1766	1766	1766	1766	1766
B036	21.1	1889	1889	1889	1889	1889	1889	1889

- See chart for specific model appliance opening limitations.
- Increased Depths available in 1/4" increments from 24 1/4" to 30".
- Reduced Depths available in 1/4" increments from 6" to 23 3/4".
- For built-in appliance support, OCINSTALLKIT is included in 24" deep cabinets, but will not be included when depth is modified.

Model	Opening Width	Maximum Width	Opening Height	Maximum Height*
B027	21"	25 1/2"	19 1/2"	27 1/2"
B030	24"	28 1/2"	19 1/2"	27 1/2"
B033	27"	31 1/2"	19 1/2"	27 1/2"
B036	30"	34 1/2"	19 1/2"	27 1/2"

*Top frame cross rail can be removed during field installation if cabinet is properly installed between two adjacent cabinets, increasing the maximum height to 28 1/4".

Door & Drawer Options

AF	CC	CG	GAMD	HC	IFHG	MC	MD	MFO	PRMD	SHMD	SPLITDR	SPLITDRWS
----	----	----	------	----	------	----	----	-----	------	------	---------	-----------

End Panel Options

AUTH	CSFPE	EXBK	EXDN	FL/FR	FPE	INTGE	IPE
✓	✓	✓	✓	✓	✓	✓	✓

Custom Modification Options

ADD	SHLF	ADTK	ADRW	ATTK	BVR	CBO	CCO	CFNTD	CFP	CFRMO	CLIP	CND	CSDGBK	DRWTK	EX	EX_OL	FLUT ¹	FTK	ID
✓	✓	✓	✓	✓	✓	✓	✓	✓	✓	✓	✓	✓	✓	✓	✓	✓	✓	✓	✓

IH	IW ²	MIP	OBRB	PFINBTMB	RD	RECTK ²	RH	ROSFLUT	RT	SCPDWR	TD	TKP ²	TVR	VTK ²	WS	WTCD	WTKCUP	WTR
✓	✓	✓	✓	✓	✓	✓	✓	✓	✓	✓	✓	✓	✓	✓	✓	✓	✓	✓

¹ 6" fluting not available on 27" wide. 6" fluting both only available on 36" wide.

² Not available on 36" wide.

IH/RH availability charts starting on page G-40.
IW/RW availability charts starting on page G-46.

BASE OVEN CABINET, 34 1/2" HIGH, 24" DEEP

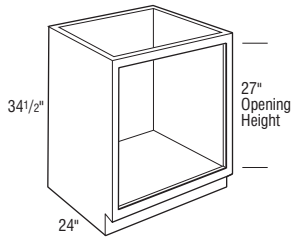

Specify appliance opening dimensions:

BO__AC Base Oven Cabinet

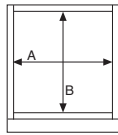

Appliance Opening Dimensions:

A _____
B _____

NOTE:

See chart for specific model appliance opening limitations.

Cabinet appliance openings may vary with modifications (i.e. clipped corner modification reduces maximum cut-out width by 3" per clipped corner).

Cubic Feet	1	2	3	4	5	6	7
BO27AC	15.7	814	814	814	814	814	814
BO30AC	17.4	903	903	903	903	903	903
BO33AC	19.0	984	984	984	984	984	984
BO36AC	20.7	1062	1062	1062	1062	1062	1062

- Includes floor under oven section.
- Specify cut-out size.
- When Beaded Inset is ordered, the cabinet should be ordered to the appropriate width using the 1/4" width modification instead of using the piece-in or cut-out applications.
- Reduced Depths available in 1/4" increments from 6" to 23 3/4".
- Ordering Maximum Width Cut-out on cabinet will change end panel thickness from 1/2" to 3/8" for non-flush ends, and from 5/8" to 1/2" for flush ends.

	Standard Appliance Opening		Decreased Appliance Opening Width*		Increased Appliance Opening Width**		Appliance Opening Height***	
	Width (A)	Height (B)	Min. Width (A)	Max. Width (A)	Min. Width (A)	Max. Width (A)	Min. Height (B)	Max. Height**** (B)
BO27AC	24"	27"	12"	23 1/2"	24 1/16"	25 1/2"	22"	27 1/2"
BO30AC	27"	27"	15"	26 1/2"	27 1/16"	28 1/2"	22"	27 1/2"
BO33AC	30"	27"	18"	29 1/2"	30 1/16"	31 1/2"	22"	27 1/2"
BO36AC	33"	27"	21"	32 1/2"	33 1/16"	34 1/2"	22"	27 1/2"

*Decreased Appliance Opening Width can vary in 1/16" increments by piecing in frame material.

**Increased Appliance Opening Width can vary in 1/16" increments by cutting out the frame stiles.

***Appliance Opening Height could have a variance of 1/16". By changing openings, it may require the door/drawer openings to change.

****Top Frame cross rail can be removed during field installation if cabinet is properly installed between two adjacent cabinets, increasing the maximum height to 28 1/2".

Door & Drawer Options

AF	CC	CG	GAMD	HC	IFHG	MC	MD	MFO	PRMD	SHMD	SPLITDR	SPLITDRWS
----	----	----	------	----	------	----	----	-----	------	------	---------	-----------

End Panel Options

AUTH	CSFPE ¹	EXBK	EXDN	FL/FR	FPE	INTGE ¹	IPE ¹
✓	✓	✓		✓	✓	✓	✓

Custom Modification Options

ADD_SHLF	ADDTK	ADRW	ATTK	BVR	CBO	CCO	CFNTO	CFP	CFRMO	CLIP	CND	CSDGBK	DRWTK ²	EX	EX_OL	FLUT ³	FTK	ID
										✓		✓	✓	✓	✓	✓	✓	✓

IH	IW ⁴	MIP	OBRB	PFINBTMB	RD	RECTK ⁴	RH	ROSFLUT	RT	SCPDRW	TD	TKP ⁴	TVR	VTK ⁴	WS	WTCD	WTKCLUP	WTR
✓	✓	✓	✓		✓	✓		✓				✓	✓	✓	✓		✓	✓

¹ Not available when cut-out width is greater than standard.

² Not available on 36" wide.

³ 6" fluting not available on 27" wide. 6" fluting both only available on 36" wide.

⁴ Not available on 36" wide.

Base Oven Cabinets

BASE OVEN CABINET with LOWER DRAWER, 34 1/2" HIGH, 24" DEEP

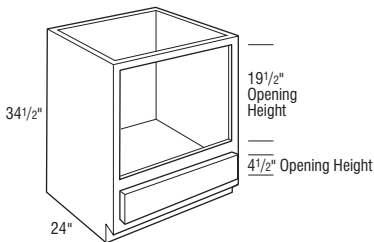

Specify appliance opening dimensions:

BO __ LD

Base Oven Cabinet with Lower Drawer

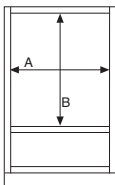

Appliance Opening Dimensions:

A _____
B _____

NOTE:

See chart for specific model appliance opening limitations.

Cabinet appliance openings may vary with modifications (i.e. clipped corner modification reduces maximum cut-out width by 3" per clipped corner).

	Cubic Feet	1	2	3	4	5	6	7
BO27LD	15.7	1362	1428	1477	1557	1650	1803	1956
BO30LD	17.4	1441	1508	1564	1648	1746	1907	2068
BO33LD	19.0	1540	1613	1672	1759	1866	2037	2208
BO36LD	20.7	1640	1700	1751	1829	1917	2064	2211

- Includes floor between oven and drawer section.
- Maintain 3" rail above drawer for full overlay clearance.
- Specify cut-out size.
- When Beaded Inset is ordered, the cabinet should be ordered to the appropriate width using the 1/4" width modification instead of using the piece-in or cut-out applications.
- Reduced Depths available in 1/4" increments from 12" to 23 3/4".
- Ordering Maximum Width Cut-out on cabinet will change end panel thickness from 1/2" to 3/8" for non-flush ends, and from 5/8" to 1/2" for flush ends.

	Standard Appliance Opening		Decreased Appliance Opening Width*		Increased Appliance Opening Width**		Appliance Opening Height***	
	Width (A)	Height (B)	Min. Width (A)	Max. Width (A)	Min. Width (A)	Max. Width (A)	Min. Height (B)	Max. Height (B)
BO27LD	24"	19 1/2"	12"	23 1/2"	24 1/16"	25 1/2"	16"	21"
BO30LD	27"	19 1/2"	15"	26 1/2"	27 1/16"	28 1/2"	16"	21"
BO33LD	30"	19 1/2"	18"	29 1/2"	30 1/16"	31 1/2"	16"	21"
BO36LD	33"	19 1/2"	21"	32 1/2"	33 1/16"	34 1/2"	16"	21"

*Decreased Appliance Opening Width can vary in 1/16" increments by piecing in frame material.

**Increased Appliance Opening Width can vary in 1/16" increments by cutting out the frame stiles.

***Appliance Opening Height could have a variance of 1/16". By changing openings, it may require the door/drawer openings to change.

Door & Drawer Options

AF	CC	CG	GAMD	HC	IFHG	MC	MD	MFO	PRMD	SHMD	SPLITDR	SPLITDRWS
----	----	----	------	----	------	----	----	-----	------	------	---------	-----------

End Panel Options

AUTH	CSFPE ¹	EXBK	EXDN	FL/FR	FPE	INTGE ¹	IPE ¹
✓	✓	✓	✓	✓	✓	✓	✓

Custom Modification Options

ADD	SHLF	ADDTK	ADRW	ATTK	BVR	CBO	CCO	CFNT0	CFP	CFRMO	CLIP	CND	CSDGBK	DRWTK ²	EX	EX_OL	FLUT	FTK	ID	
✓	✓	✓	✓	✓	✓	✓	✓	✓	✓	✓	✓	✓	✓	✓	✓	✓	✓	✓	✓	✓
IH	IW ³	MIP	OBRB	PFINBTMB	RD	RECTK ³	RH	ROSFLUT	RT	SCPDRW	TD	TKP ³	TVR ⁴	VTK ³	WS	WTC0	WTKCUP	WTR ⁴		
✓	✓	✓	✓	✓	✓	✓	✓	✓	✓	✓	✓	✓	✓	✓	✓	✓	✓	✓	✓	

¹ Not available when cut-out width is greater than standard.

² Only available on 30" wide.

³ Not available on 36" wide.

⁴ Not available on 27" wide.

IH/RH availability charts starting on page G•40.
IW/RW availability charts starting on page G•46.

Tall Microwave Cabinets

TALL BUILT-IN MICROWAVE CABINET, 84", 87", or 90" HIGH, 24" DEEP

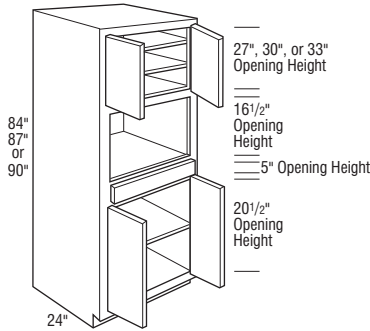

Specify appliance opening dimensions:

OCM_AC
Microwave

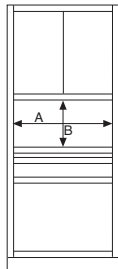

Appliance Opening Dimensions:

A _____

B _____

NOTE:

See chart for specific model appliance opening limitations.

Cabinet appliance openings may vary with modifications (i.e. clipped corner modification reduces maximum cut-out width by 3" per clipped corner).

	Cubic Feet	1	2	3	4	5	6	7
OCM278424AC	37.4	3330	3495	3622	3825	4028	4394	4760
OCM308424AC	41.3	3611	3784	3916	4132	4356	4758	5160
OCM338424AC	45.2	3827	4013	4149	4382	4621	5045	5469
OCM368424AC	49.2	4093	4293	4440	4688	4942	5399	5856
OCM398424AC	53.1	4335	4543	4698	4959	5227	5710	6193
OCM278724AC	38.7	3640	3820	3957	4174	4403	4808	5213
OCM308724AC	42.8	3916	4106	4247	4483	4724	5158	5592
OCM338724AC	46.8	4149	4351	4499	4747	5006	5468	5930
OCM368724AC	50.9	4416	4634	4792	5058	5330	5819	6308
OCM398724AC	55.0	4698	4927	5094	5376	5664	6188	6712
OCM279024AC	40.0	3951	4143	4292	4531	4778	5221	5664
OCM309024AC	44.2	4220	4427	4576	4828	5088	5555	6022
OCM339024AC	48.4	4469	4691	4848	5118	5394	5889	6384
OCM369024AC	52.6	4739	4972	5140	5423	5715	6242	6769
OCM399024AC	56.8	5063	5308	5489	5794	6100	6666	7232

- Specify cut-out size.
- When Beaded Inset is ordered, the cabinet should be ordered to the appropriate width using the 1/4" width modification instead of using the piece-in or cut-out applications.
- Cabinet openings are subject to change based on the cut-out. Please review the acknowledged drawing.
- Two adjustable shelves in upper section and one adjustable shelf on the bottom.
- Increased Depths available in 1/4" increments from 24 1/4" to 30".
- Reduced Depths available in 1/4" increments from 12" to 23 3/4".
- Ordering Maximum Width Cut-out on cabinet will change end panel thickness from 1/2" to 3/8" for non-flush ends, and from 5/8" to 1/2" for flush ends.

	Standard Appliance Opening		Decreased Appliance Opening Width*		Increased Appliance Opening Width**		Appliance Opening Height***	
	Width (A)	Height (B)	Min. Width (A)	Max. Width (A)	Min. Width (A)	Max. Width (A)	Min. Height (B)	Max. Height (B)
OCM278424AC	24"	16 1/2"	12"	23 1/2"	24 1/16"	25 1/2"	12"	23 1/2"
OCM308424AC	27"	16 1/2"	15"	26 1/2"	27 1/16"	28 1/2"	12"	23 1/2"
OCM338424AC	30"	16 1/2"	18"	29 1/2"	30 1/16"	31 1/2"	12"	23 1/2"
OCM368424AC	33"	16 1/2"	21"	32 1/2"	33 1/16"	34 1/2"	12"	23 1/2"
OCM398424AC	36"	16 1/2"	24"	35 1/2"	36 1/16"	37 1/2"	12"	23 1/2"
OCM278724AC	24"	16 1/2"	12"	23 1/2"	24 1/16"	25 1/2"	12"	23 1/2"
OCM308724AC	27"	16 1/2"	15"	26 1/2"	27 1/16"	28 1/2"	12"	23 1/2"
OCM338724AC	30"	16 1/2"	18"	29 1/2"	30 1/16"	31 1/2"	12"	23 1/2"
OCM368724AC	33"	16 1/2"	21"	32 1/2"	33 1/16"	34 1/2"	12"	23 1/2"
OCM398724AC	36"	16 1/2"	24"	35 1/2"	36 1/16"	37 1/2"	12"	23 1/2"
OCM279024AC	24"	16 1/2"	12"	23 1/2"	24 1/16"	25 1/2"	12"	23 1/2"
OCM309024AC	27"	16 1/2"	15"	26 1/2"	27 1/16"	28 1/2"	12"	23 1/2"
OCM339024AC	30"	16 1/2"	18"	29 1/2"	30 1/16"	31 1/2"	12"	23 1/2"
OCM369024AC	33"	16 1/2"	21"	32 1/2"	33 1/16"	34 1/2"	12"	23 1/2"
OCM399024AC	36"	16 1/2"	24"	35 1/2"	36 1/16"	37 1/2"	12"	23 1/2"

*Decreased Appliance Opening Width can vary in 1/16" increments by piecing in frame material.

**Increased Appliance Opening Width can vary in 1/16" increments by cutting out the frame stiles.

***Appliance Opening Height could have a variance of 1/16". By changing openings, it may require the door/drawer openings to change.

Door & Drawer Options

AF	CC	CG	GAMD	HC	IFHG	MC	MD	MFO	PRMD	SHMD ¹	SPLITDR	SPLITDRWS

End Panel Options

AUTH	CSFPE ²	EXBK	EXDN	FL/FR	FPE	INTGE ²	IPE ²

Custom Modification Options

ADD_SHLF	ADDTK	ADRW	ATTK	BVR	CBO	CCO	CFNT0	CFP	CFRMO	CLIP	CND	CSDGBK	DRWTK ³	EX	EX_OL	FLUT ⁴	FTK	ID	

IH	IW ⁵	MIP	ORBR	PFINBTMB	RD	RECTK	RH	ROSLUT	RT	SCDRW	TD	TKP	TVR	VTK	WS	WTC	WTKCUP	WTR	

¹ Only available on top section.

² Not available when cut-out width is greater than standard.

³ Not available on units over 36" wide.

⁴ Not available with 6" fluting.

⁵ Not available on 39" wide.

Tall Microwave Cabinets

TALL BUILT-IN MICROWAVE CABINET, 93" or 96" HIGH, 24" DEEP

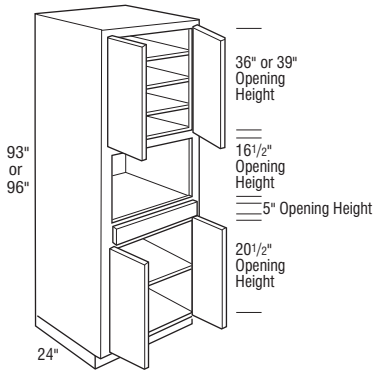

Specify appliance opening dimensions:

OCM _ _ AC
Microwave

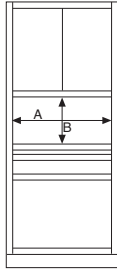

Appliance Opening Dimensions:

A _____
B _____

NOTE:

See chart for specific model appliance opening limitations.

Cabinet appliance openings may vary with modifications (i.e. clipped corner modification reduces maximum cut-out width by 3" per clipped corner).

	Cubic Feet	1	2	3	4	5	6	7
OCM279324AC	41.3	4058	4256	4408	4650	4908	5362	5816
OCM309324AC	45.7	4366	4579	4737	4998	5265	5752	6239
OCM339324AC	50.0	4628	4852	5019	5298	5579	6096	6613
OCM369324AC	54.3	4902	5145	5324	5615	5912	6463	7014
OCM399324AC	58.7	5238	5494	5685	5998	6318	6905	7492

• Includes two adjustable shelves in upper section and one adjustable shelf on the bottom.

OCM279624AC	42.6	4168	4371	4531	4777	5038	5500	5962
OCM309624AC	47.1	4507	4732	4896	5164	5441	5948	6455
OCM339624AC	51.6	4780	5014	5193	5477	5765	6305	6845
OCM369624AC	56.1	5067	5314	5501	5804	6113	6680	7247
OCM399624AC	60.6	5410	5676	5878	6201	6529	7140	7751

• Includes three adjustable shelves in upper section and one adjustable shelf on the bottom.

• Flush ToeKick modification not available in conjunction with Wide Top Rail unless loose Flush ToeKick is specified.

Notes below apply to all products in section above:

- Specify cut-out size.
- When Beaded Inset is ordered, the cabinet should be ordered to the appropriate width using the 1/4" width modification instead of using the piece-in or cut-out applications.
- Cabinet openings are subject to change based on the cut-out. Please review the acknowledged drawing.
- Shipped with loose toe space unless Attach ToeKick or Flush ToeKick is specified.
- Increased Depths available in 1/4" increments from 24 1/4" to 30".
- Reduced Depths available in 1/4" increments from 12" to 23 3/4".
- Ordering Maximum Width Cut-out on cabinet will change end panel thickness from 1/2" to 3/8" for non-flush ends, and from 5/8" to 1/2" for flush ends.

	Standard Appliance Opening		Decreased Appliance Opening Width*		Increased Appliance Opening Width**		Appliance Opening Height***	
	Width (A)	Height (B)	Min. Width (A)	Max. Width (A)	Min. Width (A)	Max. Width (A)	Min. Height (B)	Max. Height (B)
OCM279324AC	24"	16 1/2"	12"	23 1/2"	24 1/16"	25 1/2"	12"	23 1/2"
OCM309324AC	27"	16 1/2"	15"	26 1/2"	27 1/16"	28 1/2"	12"	23 1/2"
OCM339324AC	30"	16 1/2"	18"	29 1/2"	30 1/16"	31 1/2"	12"	23 1/2"
OCM369324AC	33"	16 1/2"	21"	32 1/2"	33 1/16"	34 1/2"	12"	23 1/2"
OCM399324AC	36"	16 1/2"	24"	35 1/2"	36 1/16"	37 1/2"	12"	23 1/2"
OCM279624AC	24"	16 1/2"	12"	23 1/2"	24 1/16"	25 1/2"	12"	23 1/2"
OCM309624AC	27"	16 1/2"	15"	26 1/2"	27 1/16"	28 1/2"	12"	23 1/2"
OCM339624AC	30"	16 1/2"	18"	29 1/2"	30 1/16"	31 1/2"	12"	23 1/2"
OCM369624AC	33"	16 1/2"	21"	32 1/2"	33 1/16"	34 1/2"	12"	23 1/2"
OCM399624AC	36"	16 1/2"	24"	35 1/2"	36 1/16"	37 1/2"	12"	23 1/2"

*Decreased Appliance Opening Width can vary in 1/16" increments by piecing in frame material.

**Increased Appliance Opening Width can vary in 1/16" increments by cutting out the frame stiles.

***Appliance Opening Height could have a variance of 1/16". By changing openings, it may require the door/drawer openings to change.

Door & Drawer Options

AF	CC	CG	GAMD	HC	IFHG	MC	MD	MFO	PRMD	SHMD ¹	SPLITDR	SPLITDRWS
✓	✓	✓	✓	✓	✓	✓	✓	✓	✓	✓	✓	✓

End Panel Options

AUTH	CSFPE ²	EXBK	EXDN	FL/FR	FPE	INTGE ²	IPE ²
✓	✓	✓	✓	✓	✓	✓	✓

Custom Modification Options

ADD	SHLF	ADTK	ADRW	ATTK	BVR	CBO	CCO	CFNTD	CFP	CFRMO	CLIP	CND	CSDGBK	DRWTK ³	EX	EX_OL	FLUT ⁴	FTK	ID	
✓	✓	✓	✓	✓	✓	✓	✓	✓	✓	✓	✓	✓	✓	✓	✓	✓	✓	✓	✓	✓

IH	IW ⁵	MIP	OBRB	PFINBTMB	RD	RECTK	RH	ROSFLUT	RT	SCPDRW	TD	TKP	TVR	VTK	WS	WTCB	WTKCUP	WTR	
✓	✓	✓	✓	✓	✓	✓	✓	✓	✓	✓	✓	✓	✓	✓	✓	✓	✓	✓	✓

¹ Only available on top section.

² Not available when cut-out width is greater than standard.

³ Not available on units over 36" wide and only available when used in conjunction with attach toeKick modification.

⁴ Not available with 6" fluting.

⁵ Not available on 39" wide.

IH/RH availability charts starting on page G•40.
IW/RW availability charts starting on page G•46.

TALL BUILT-IN MICROWAVE CABINET, 102" or 108" HIGH, 24" DEEP

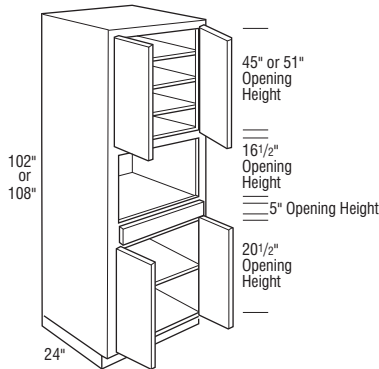

Specify appliance opening dimensions:

OCM_AC

Microwave

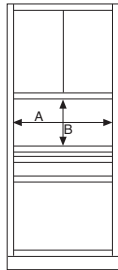

Appliance Opening Dimensions:

A _____
B _____

NOTE:

See chart for specific model appliance opening limitations.

Cabinet appliance openings may vary with modifications (i.e. clipped corner modification reduces maximum cut-out width by 3" per clipped corner).

	Cubic Feet	1	2	3	4	5	6	7
OCM2710224AC	61.9	7158	7440	7662	8003	8365	9006	9647
OCM3010224AC	67.5	7628	7941	8168	8540	8924	9628	10332
OCM3310224AC	73.1	8007	8332	8580	8974	9374	10123	10872
OCM3610224AC	78.8	8405	8748	9008	9428	9857	10644	11431
OCM3910224AC	84.4	8881	9250	9531	9979	10434	11282	12130
OCM2710824AC	65.3	7945	8258	8505	8883	9285	9997	10709
OCM3010824AC	71.3	8468	8814	9067	9479	9906	10687	11468
OCM3310824AC	77.2	8888	9248	9524	9962	10405	11237	12069
OCM3610824AC	83.1	9330	9710	9998	10465	10941	11814	12687
OCM3910824AC	89.1	9858	10268	10579	11077	11582	12523	13464

- Specify cut-out size.
- When Beaded Inset is ordered, the cabinet should be ordered to the appropriate width using the 1/4" width modification instead of using the piece-in or cut-out applications.
- Cabinet openings are subject to change based on the cut-out. Please review the acknowledged drawing.
- Shipped with loose toe space unless Attach Toekick or Flush Toekick is specified.
- Units include three adjustable shelves in upper section and one adjustable shelf on the bottom.
- Increased Depths available in 1/4" increments from 24 1/4" to 26".
- Reduced Depths available in 1/4" increments from 12" to 23 3/4".
- Finish Flushed Ends standard.

	Standard Appliance Opening		Decreased Appliance Opening Width*		Increased Appliance Opening Width**		Appliance Opening Height***	
	Width (A)	Height (B)	Min. Width (A)	Max. Width (A)	Min. Width (A)	Max. Width (A)	Min. Height (B)	Max. Height (B)
OCM2710224AC	24"	16 1/2"	12"	23 1/2"	24 1/16"	25"	12"	23 1/2"
OCM3010224AC	27"	16 1/2"	15"	26 1/2"	27 1/16"	28"	12"	23 1/2"
OCM3310224AC	30"	16 1/2"	18"	29 1/2"	30 1/16"	31"	12"	23 1/2"
OCM3610224AC	33"	16 1/2"	21"	32 1/2"	33 1/16"	34"	12"	23 1/2"
OCM3910224AC	36"	16 1/2"	24"	35 1/2"	36 1/16"	37"	12"	23 1/2"
OCM2710824AC	24"	16 1/2"	12"	23 1/2"	24 1/16"	25"	12"	23 1/2"
OCM3010824AC	27"	16 1/2"	15"	26 1/2"	27 1/16"	28"	12"	23 1/2"
OCM3310824AC	30"	16 1/2"	18"	29 1/2"	30 1/16"	31"	12"	23 1/2"
OCM3610824AC	33"	16 1/2"	21"	32 1/2"	33 1/16"	34"	12"	23 1/2"
OCM3910824AC	36"	16 1/2"	24"	35 1/2"	36 1/16"	37"	12"	23 1/2"

*Decreased Appliance Opening Width can vary in 1/16" increments by piecing in frame material.

**Increased Appliance Opening Width can vary in 1/16" increments by cutting out the frame stiles.

***Appliance Opening Height could have a variance of 1/16". By changing openings, it may require the door/drawer openings to change.

Door & Drawer Options

AF	CC	CG	GAMD	HC	IFHG	MC	MD	MFO	PRMD	SHMD ¹	SPLITDR	SPLITDRWS
✓	✓	✓	✓	✓	✓	✓	✓	✓	✓	✓	✓	✓

End Panel Options

AUTH	CSFPE	EXBK ²	EXDN	FL/FR	FPE	INTGE	IPE
✓	✓	✓	✓	✓	✓	✓	✓

Custom Modification Options

ADD_SHLF	ADDTK	ADRW	ATTK	BVR	CBO	CCO	CFNTO	CFP	CFRMO	CLIP	CND	CSDGBK	DRWTK ³	EX	EX_OL	FLUT ⁴	FTK	ID	
✓	✓	✓	✓	✓	✓	✓	✓	✓	✓	✓	✓	✓	✓	✓	✓	✓	✓	✓	✓

IH ⁵	IW ⁶	MIP	OBRB	PFINBTMB	RD	RECTK	RH ⁵	ROSFLUT ⁴	RT	SCPDRW	TD ⁷	TKP	TVR	VTK	WS	WTCB	WTKCUP	WTR	
✓	✓	✓	✓	✓	✓	✓	✓	✓	✓	✓	✓	✓	✓	✓	✓	✓	✓	✓	✓

¹ Only available on top section.

² This modification will allow the end to extend back to a maximum of 30" deep.

³ Not available on units over 36" wide and only available when used in conjunction with attach toekick modification.

⁴ Not available with 6" fluting.

⁵ Not available on 108" high.

⁶ Not available on 39" wide.

⁷ Only available on bottom section.

Oven Microwave Cabinets

OVEN MICROWAVE TRIMMABLE CABINET, 84", 87", or 90" HIGH, 24" DEEP

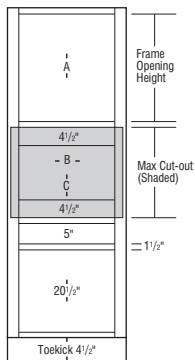
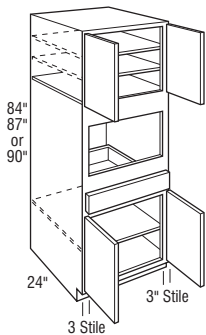

	Cubic Feet	1	2	3	4	5	6	7
TBMWB278424AH	37.4	3330	3495	3622	3825	4028	4394	4760
TBMWB308424AH	41.3	3611	3784	3916	4132	4356	4758	5160
TBMWB338424AH	45.2	3827	4013	4149	4382	4621	5045	5469
TBMWB368424AH	49.2	4093	4293	4440	4688	4942	5399	5856
TBMWB398424AH	52.4	4335	4543	4698	4959	5227	5710	6193
TBMWB278724	38.7	3640	3820	3957	4174	4403	4808	5213
TBMWB308724	42.0	3916	4106	4247	4483	4724	5158	5592
TBMWB338724	46.8	4149	4351	4499	4747	5006	5468	5930
TBMWB368724	50.9	4416	4634	4792	5058	5330	5819	6308
TBMWB398724	54.3	4698	4927	5094	5376	5664	6188	6712
TBMWB279024	40.0	3951	4143	4292	4531	4778	5221	5664
TBMWB309024	44.2	4220	4427	4576	4828	5088	5555	6022
TBMWB339024	47.8	4469	4691	4848	5118	5394	5889	6384
TBMWB369024	52.6	4739	4972	5140	5423	5715	6242	6769
TBMWB399024	56.1	5063	5308	5489	5794	6100	6666	7232

- AH represents upper section alignment with doors on 24" or 27" high cabinets.
- All top and bottom cross rails are 1 1/2" wide.
- Includes two adjustable shelves in upper section and one adjustable shelf on the bottom.
- Cabinet installation kit will not be included when depth is modified.
- A cabinet installation kit will be provided.
- Oven cabinet cut-out is shaded in gray and is cut out on job site.
- Increased Heights modification will increase the height of the upper cabinet section. The bottom section will retain its original height.

	A Frame Opening Height	B Cut-out Width		C Cut-out Height		Door Height (Upper Section) Full Overlay
		Min.	Max.	Min.	Max.	
TBMWB278424AH	24"	21"	25 1/2"	13 1/2"	22 1/2"	26 1/2"
TBMWB308424AH	24"	24"	28 1/2"	13 1/2"	22 1/2"	26 1/2"
TBMWB338424AH	24"	27"	31 1/2"	13 1/2"	22 1/2"	26 1/2"
TBMWB368424AH	24"	30"	34 1/2"	13 1/2"	22 1/2"	26 1/2"
TBMWB398424AH	24"	33"	37 1/2"	13 1/2"	22 1/2"	26 1/2"
TBMWB278724	27"	21"	25 1/2"	13 1/2"	22 1/2"	29 1/2"
TBMWB308724	27"	24"	28 1/2"	13 1/2"	22 1/2"	29 1/2"
TBMWB338724	27"	27"	31 1/2"	13 1/2"	22 1/2"	29 1/2"
TBMWB368724	27"	30"	34 1/2"	13 1/2"	22 1/2"	29 1/2"
TBMWB398724	27"	33"	37 1/2"	13 1/2"	22 1/2"	29 1/2"
TBMWB279024	30"	21"	25 1/2"	13 1/2"	22 1/2"	32 1/2"
TBMWB309024	30"	24"	28 1/2"	13 1/2"	22 1/2"	32 1/2"
TBMWB339024	30"	27"	31 1/2"	13 1/2"	22 1/2"	32 1/2"
TBMWB369024	30"	30"	34 1/2"	13 1/2"	22 1/2"	32 1/2"
TBMWB399024	30"	33"	37 1/2"	13 1/2"	22 1/2"	32 1/2"

Maximum cut-out dimension will allow 1/4" reveal for doors and drawer fronts on full overlay for trim kit face clearance.

Door & Drawer Options

AF	CC	CG	GAMD	HC	IFHG	MC	MD	MFO	PRMD	SHMD	SPLITDR	SPLITDRWS
<input checked="" type="checkbox"/>	<input checked="" type="checkbox"/>	<input checked="" type="checkbox"/>	<input checked="" type="checkbox"/>	<input checked="" type="checkbox"/>	<input checked="" type="checkbox"/>	<input checked="" type="checkbox"/>	<input checked="" type="checkbox"/>	<input checked="" type="checkbox"/>	<input checked="" type="checkbox"/>	<input checked="" type="checkbox"/>	<input checked="" type="checkbox"/>	<input checked="" type="checkbox"/>

End Panel Options

AUTH	CSFPE	EXBK	EXDN	FL/FR	FPE	INTGE	IPE
<input checked="" type="checkbox"/>	<input checked="" type="checkbox"/>	<input checked="" type="checkbox"/>	<input checked="" type="checkbox"/>	<input checked="" type="checkbox"/>	<input checked="" type="checkbox"/>	<input checked="" type="checkbox"/>	<input checked="" type="checkbox"/>

Custom Modification Options

ADD	SHLF	ADTK	ADRW	ATTK	BVR	CBO	CCO	CFNTO	CFP	CFRMO	CLIP	CND	CSDGBK	DRWK ¹	EX	EX_OL	FLUT ²	FTK	ID
<input checked="" type="checkbox"/>	<input checked="" type="checkbox"/>	<input checked="" type="checkbox"/>	<input checked="" type="checkbox"/>	<input checked="" type="checkbox"/>	<input checked="" type="checkbox"/>	<input checked="" type="checkbox"/>	<input checked="" type="checkbox"/>	<input checked="" type="checkbox"/>	<input checked="" type="checkbox"/>	<input checked="" type="checkbox"/>	<input checked="" type="checkbox"/>	<input checked="" type="checkbox"/>	<input checked="" type="checkbox"/>	<input checked="" type="checkbox"/>	<input checked="" type="checkbox"/>	<input checked="" type="checkbox"/>	<input checked="" type="checkbox"/>	<input checked="" type="checkbox"/>	<input checked="" type="checkbox"/>

IH	IW ³	MIP	OBRB	PFINBTMB	RD	RECTK	RH	ROSFLUT	RT	SCPDWR	TD	TKP	TVR	VTK	WS	WTCD	WTKCUP	WTR	
<input checked="" type="checkbox"/>	<input checked="" type="checkbox"/>	<input checked="" type="checkbox"/>	<input checked="" type="checkbox"/>	<input checked="" type="checkbox"/>	<input checked="" type="checkbox"/>	<input checked="" type="checkbox"/>	<input checked="" type="checkbox"/>	<input checked="" type="checkbox"/>	<input checked="" type="checkbox"/>	<input checked="" type="checkbox"/>	<input checked="" type="checkbox"/>	<input checked="" type="checkbox"/>	<input checked="" type="checkbox"/>	<input checked="" type="checkbox"/>	<input checked="" type="checkbox"/>	<input checked="" type="checkbox"/>	<input checked="" type="checkbox"/>	<input checked="" type="checkbox"/>	<input checked="" type="checkbox"/>

¹ Not available on units over 36" wide.

² Not available with 6" fluting.

³ Not available on 39" wide.

IH/RH availability charts starting on page G-40.
IW/RW availability charts starting on page G-46.

OVEN MICROWAVE TRIMMABLE CABINET, 93" or 96" HIGH, 24" DEEP

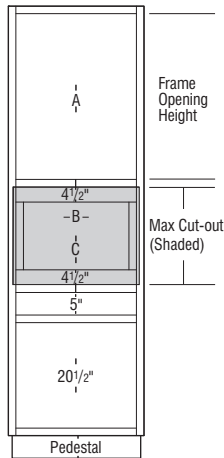
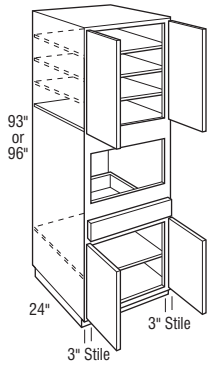

	Cubic Feet	1	2	3	4	5	6	7
TBMWB279324	41.3	4058	4256	4408	4650	4908	5362	5816
TBMWB309324	45.7	4366	4579	4737	4998	5265	5752	6239
TBMWB339324	50.0	4628	4852	5019	5298	5579	6096	6613
TBMWB369324	54.3	4902	5145	5324	5615	5912	6463	7014
TBMWB399324	57.9	5238	5494	5685	5998	6318	6905	7492

• Includes two adjustable shelves in upper section and one adjustable shelf on the bottom.

TBMWB279624	42.6	4168	4371	4531	4777	5038	5500	5962
TBMWB309624	47.1	4507	4732	4896	5164	5441	5948	6455
TBMWB339624	51.6	4780	5014	5193	5477	5765	6305	6845
TBMWB369624	56.1	5067	5314	5501	5804	6113	6680	7247
TBMWB399624	59.8	5410	5676	5878	6201	6529	7140	7751

• Includes three adjustable shelves in upper section and one adjustable shelf on the bottom.
 • Flush toe kick option not available in conjunction with Wide Top Rail unless loose Flush Toe Kick is specified.

Notes below apply to all products in section above:

- Shipped with loose toe kick unless ATTK or Flush Toe Kick is specified.
- Cabinet installation kit will not be included when depth is modified.
- A cabinet installation kit will be provided.
- Oven cabinet cut-out is shaded in gray and is cut out on job site.
- Increased Heights modification will increase the height of the upper cabinet section. The bottom section will retain its original height.

	A Frame Opening Height	B Cut-out Width		C Cut-out Height		Door Height (Upper Section) Full Overlay
		Min.	Max.	Min.	Max.	
TBMWB279324	33"	21"	25 1/2"	13 1/2"	22 1/2"	35 1/2"
TBMWB309324	33"	24"	28 1/2"	13 1/2"	22 1/2"	35 1/2"
TBMWB339324	33"	27"	31 1/2"	13 1/2"	22 1/2"	35 1/2"
TBMWB369324	33"	30"	34 1/2"	13 1/2"	22 1/2"	35 1/2"
TBMWB399324	33"	33"	37 1/2"	13 1/2"	22 1/2"	35 1/2"
TBMWB279624	36"	21"	25 1/2"	13 1/2"	22 1/2"	38 1/2"
TBMWB309624	36"	24"	28 1/2"	13 1/2"	22 1/2"	38 1/2"
TBMWB339624	36"	27"	31 1/2"	13 1/2"	22 1/2"	38 1/2"
TBMWB369624	36"	30"	34 1/2"	13 1/2"	22 1/2"	38 1/2"
TBMWB399624	36"	33"	37 1/2"	13 1/2"	22 1/2"	38 1/2"

Maximum cut-out dimension will allow 1/4" reveal for doors and drawer fronts on full overlay for trim kit face clearance.

Door & Drawer Options

AF	CC	CG	GAMD	HC	IFHG	MC	MD	MFO	PRMD	SHMD	SPLITDR	SPLITDRWS
✓	✓	✓	✓	✓	✓	✓	✓	✓	✓	✓	✓	✓

End Panel Options

AUTH	CSFPE	EXBK	EXDN	FL/FR	FPE	INTGE	IPE
✓	✓	✓	✓	✓	✓	✓	✓

Custom Modification Options

ADD_SHLF	ADDTK	ADRW	ATTK	BVR	CBO	CCO	CFNTO	CFP	CFRMO	CLIP	CND	CSDGBK	DRWTK ¹	EX	EX_OL	FLUT ²	FTK	ID	
✓	✓	✓	✓	✓	✓	✓	✓	✓	✓	✓	✓	✓	✓	✓	✓	✓	✓	✓	✓

IH ³	IW ⁴	MIP	OBRB	PFINBTMB	RD	RECTK	RH	ROSFLUT	RT	SCPDRW	TD	TKP	TVR	VTK	WS	WTCD	WTKCUP	WTR	
✓	✓	✓	✓	✓	✓	✓	✓	✓	✓	✓	✓	✓	✓	✓	✓	✓	✓	✓	✓

¹ Not available on units over 36" wide and only available when used in conjunction with attach toe kick modification.

² Not available with 6" fluting.

³ Not available on 96" high.

⁴ Not available on 39" wide.

Oven Microwave Cabinets

BUILT-IN OVEN MICROWAVE CABINET, 84" or 87" HIGH, 24" DEEP

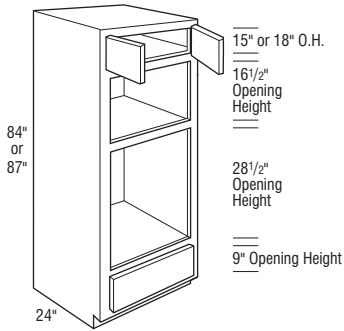

Specify appliance opening dimensions:

OMC_AC

Microwave/Single Oven

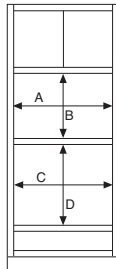

Appliance Opening Dimensions:

A _____
 B _____
 C _____
 D _____

NOTE:

See chart for specific model appliance opening limitations.

Cabinet appliance openings may vary with modifications (i.e. clipped corner modification reduces maximum cut-out width by 3" per clipped corner).

	Cubic Feet	1	2	3	4	5	6	7
OMC278424AC	37.4	2759	2893	2998	3165	3323	3633	3943
OMC308424AC	41.3	3289	3449	3570	3767	3969	4336	4703
OMC338424AC	45.2	3448	3619	3741	3951	4159	4547	4935
OMC368424AC	49.2	3791	3978	4117	4344	4576	5002	5428
OMC398424AC	53.1	3966	4159	4301	4544	4783	5228	5673
OMC278724AC	38.7	2997	3143	3256	3435	3607	3944	4281
OMC308724AC	42.8	3568	3741	3876	4087	4306	4704	5102
OMC338724AC	46.8	3704	3886	4024	4244	4466	4884	5302
OMC368724AC	50.9	4076	4275	4427	4669	4912	5372	5832
OMC398724AC	55.0	4258	4468	4628	4879	5135	5616	6097

- Specify cut-out size.
- When Beaded Inset is ordered, the cabinet should be ordered to the appropriate width using the 1/4" width modification instead of using the piece-in or cut-out applications.
- Cabinet openings are subject to change based on the cut-out. Please review the acknowledged drawing.
- Increased Depths available in 1/4" increments from 24 1/4" to 30".
- Reduced Depths available in 1/4" increments from 12" to 23 3/4".
- Ordering Maximum Width Cut-out on cabinet will change end panel thickness from 1/2" to 3/8" for non-flush ends, and from 5/8" to 1/2" for flush ends.

Microwave	Standard Appliance Opening		Decreased Appliance Opening Width*		Increased Appliance Opening Width**		Appliance Opening Height***	
	Width (A)	Height (B)	Min. Width (A)	Max. Width (A)	Min. Width (A)	Max. Width (A)	Min. Height (B)	Max. Height (B)
OMC278424AC	24"	16 1/2"	12"	23 1/2"	24 1/16"	25 1/2"	14"	19 1/2"
OMC308424AC	27"	16 1/2"	15"	26 1/2"	27 1/16"	28 1/2"	14"	19 1/2"
OMC338424AC	30"	16 1/2"	18"	29 1/2"	30 1/16"	31 1/2"	14"	19 1/2"
OMC368424AC	33"	16 1/2"	21"	32 1/2"	33 1/16"	34 1/2"	14"	19 1/2"
OMC398424AC	36"	16 1/2"	24"	35 1/2"	36 1/16"	37 1/2"	14"	19 1/2"
OMC278724AC	24"	16 1/2"	12"	23 1/2"	24 1/16"	25 1/2"	14"	19 1/2"
OMC308724AC	27"	16 1/2"	15"	26 1/2"	27 1/16"	28 1/2"	14"	19 1/2"
OMC338724AC	30"	16 1/2"	18"	29 1/2"	30 1/16"	31 1/2"	14"	19 1/2"
OMC368724AC	33"	16 1/2"	21"	32 1/2"	33 1/16"	34 1/2"	14"	19 1/2"
OMC398724AC	36"	16 1/2"	24"	35 1/2"	36 1/16"	37 1/2"	14"	19 1/2"

*Decreased Appliance Opening Width can vary in 1/16" increments by piecing in frame material.

**Increased Appliance Opening Width can vary in 1/16" increments by cutting out the frame stiles.

***Appliance Opening Height could have a variance of 1/16". By changing openings, it may require the door/drawer openings to change.

Oven	Standard Appliance Opening		Decreased Appliance Opening Width*		Increased Appliance Opening Width**		Appliance Opening Height***	
	Width (C)	Height (D)	Min. Width (C)	Max. Width (C)	Min. Width (C)	Max. Width (C)	Min. Height (D)	Max. Height (D)
OMC278424AC	24"	28 1/2"	12"	23 1/2"	24 1/16"	25 1/2"	25 1/2"	32 1/2"
OMC308424AC	27"	28 1/2"	15"	26 1/2"	27 1/16"	28 1/2"	25 1/2"	32 1/2"
OMC338424AC	30"	28 1/2"	18"	29 1/2"	30 1/16"	31 1/2"	25 1/2"	32 1/2"
OMC368424AC	33"	28 1/2"	21"	32 1/2"	33 1/16"	34 1/2"	25 1/2"	32 1/2"
OMC398424AC	36"	28 1/2"	24"	35 1/2"	36 1/16"	37 1/2"	25 1/2"	32 1/2"
OMC278724AC	24"	28 1/2"	12"	23 1/2"	24 1/16"	25 1/2"	25 1/2"	32 1/2"
OMC308724AC	27"	28 1/2"	15"	26 1/2"	27 1/16"	28 1/2"	25 1/2"	32 1/2"
OMC338724AC	30"	28 1/2"	18"	29 1/2"	30 1/16"	31 1/2"	25 1/2"	32 1/2"
OMC368724AC	33"	28 1/2"	21"	32 1/2"	33 1/16"	34 1/2"	25 1/2"	32 1/2"
OMC398724AC	36"	28 1/2"	24"	35 1/2"	36 1/16"	37 1/2"	25 1/2"	32 1/2"

Door & Drawer Options

AF	CC	CG	GAMD	HC	IFHG	MC	MD	MFO	PRMD	SHMD	SPLITDR	SPLITDRWS

End Panel Options

AUTH	CSFPE ¹	EXBK	EXDN	FL/FR	FPE	INTGE ¹	IPE ¹

Custom Modification Options

ADD	SHLF	ADDTK	ADRW	ATTK	BVR	CBO	CCO	CFNTD	CFP	CFRMO	CLIP	CND	CSDBGK	DRWK ²	EX	EX_OL	FLUT ³	FTK	ID

IH	IW ⁴	IMP	OBRB	PFINBTMB	RD	RECTK	RH	ROSFLUT	RT	SCPDRW	TD	TKP	TVR	VTK	WS	WTCD	WTKCUP	WTR

¹ Not available when cut-out width is greater than standard.

² Not available on units over 36" wide.

³ Not available with 6" fluting.

⁴ Not available on 39" wide.

IH/RH availability charts starting on page G•40.
 IW/RW availability charts starting on page G•46.

BUILT-IN OVEN MICROWAVE CABINET, 90" HIGH, 24" DEEP

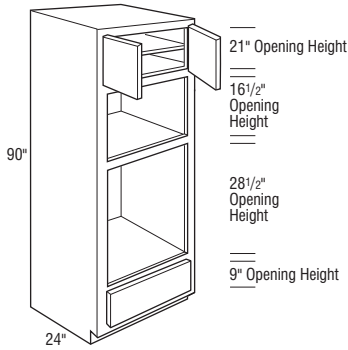

Specify appliance opening dimensions:

OMC_AC Microwave/Single Oven

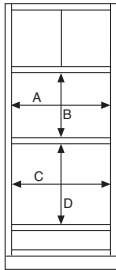

Appliance Opening Dimensions:

A _____
B _____
C _____
D _____

NOTE:

See chart for specific model appliance opening limitations.

Cabinet appliance openings may vary with modifications (i.e. clipped corner modification reduces maximum cut-out width by 3" per clipped corner).

	Cubic Feet	1	2	3	4	5	6	7
OMC279024AC	40.0	3235	3392	3512	3704	3892	4254	4616
OMC309024AC	44.2	3847	4034	4179	4406	4641	5076	5511
OMC339024AC	48.4	3961	4156	4303	4536	4771	5218	5665
OMC369024AC	52.6	4356	4569	4734	4985	5244	5740	6236
OMC399024AC	56.8	4553	4777	4949	5212	5483	6002	6521

- Specify cut-out size.
- When Beaded Inset is ordered, the cabinet should be ordered to the appropriate width using the 1/4" width modification instead of using the piece-in or cut-out applications.
- Cabinet openings are subject to change based on the cut-out. Please review the acknowledged drawing.
- 90" high includes one adjustable shelf in upper section.
- Increased Depths available in 1/4" increments from 24 1/4" to 30".
- Reduced Depths available in 1/4" increments from 12" to 23 3/4".
- Ordering Maximum Width Cut-out on cabinet will change end panel thickness from 1/2" to 3/8" for non-flush ends, and from 5/8" to 1/2" for flush ends.

Microwave	Standard Appliance Opening		Decreased Appliance Opening Width*		Increased Appliance Opening Width**		Appliance Opening Height***	
	Width (A)	Height (B)	Min. Width (A)	Max. Width (A)	Min. Width (A)	Max. Width (A)	Min. Height (B)	Max. Height (B)
OMC279024AC	24"	16 1/2"	12"	23 1/2"	24 1/16"	25 1/2"	14"	19 1/2"
OMC309024AC	27"	16 1/2"	15"	26 1/2"	27 1/16"	28 1/2"	14"	19 1/2"
OMC339024AC	30"	16 1/2"	18"	29 1/2"	30 1/16"	31 1/2"	14"	19 1/2"
OMC369024AC	33"	16 1/2"	21"	32 1/2"	33 1/16"	34 1/2"	14"	19 1/2"
OMC399024AC	36"	16 1/2"	24"	35 1/2"	36 1/16"	37 1/2"	14"	19 1/2"

*Decreased Appliance Opening Width can vary in 1/16" increments by piecing in frame material.

**Increased Appliance Opening Width can vary in 1/16" increments by cutting out the frame stiles.

***Appliance Opening Height could have a variance of 1/16". By changing openings, it may require the door/drawer openings to change.

Oven	Standard Appliance Opening		Decreased Appliance Opening Width*		Increased Appliance Opening Width**		Appliance Opening Height***	
	Width (C)	Height (D)	Min. Width (C)	Max. Width (C)	Min. Width (C)	Max. Width (C)	Min. Height (D)	Max. Height (D)
OMC279024AC	24"	28 1/2"	12"	23 1/2"	24 1/16"	25 1/2"	25 1/2"	32 1/2"
OMC309024AC	27"	28 1/2"	15"	26 1/2"	27 1/16"	28 1/2"	25 1/2"	32 1/2"
OMC339024AC	30"	28 1/2"	18"	29 1/2"	30 1/16"	31 1/2"	25 1/2"	32 1/2"
OMC369024AC	33"	28 1/2"	21"	32 1/2"	33 1/16"	34 1/2"	25 1/2"	32 1/2"
OMC399024AC	36"	28 1/2"	24"	35 1/2"	36 1/16"	37 1/2"	25 1/2"	32 1/2"

Door & Drawer Options

AF	CC	CG	GAMD	HC	IFHG	MC	MD	MFO	PRMD	SHMD	SPLITDR	SPLITDRWS

End Panel Options

AUTH	CSFPE ¹	EXBK	EXDN	FL/FR	FPE	INTGE ¹	IPE ¹

Custom Modification Options

ADD_SHLF	ADDTK	ADRW	ATTK	BVR	CBO	CCO	CFNTO	CFP	CFRMO	CLIP	CND	CSDGBK	DRWTK ²	EX	EX_OL	FLUT ³	FTK	ID

IH	IW ⁴	MIP	OBRB	PFINBTMB	RD	RECTK	RH	ROSLUT	RT	SCPDRW	TD	TKP	TVR	VTK	WS	WTCO	WTKCUP	WTR

¹ Not available when cut-out width is greater than standard.

² Not available on units over 36" wide.

³ Not available with 6" fluting.

⁴ Not available on 39" wide.

Oven Microwave Cabinets

BUILT-IN OVEN MICROWAVE CABINET, 93" or 96" HIGH, 24" DEEP

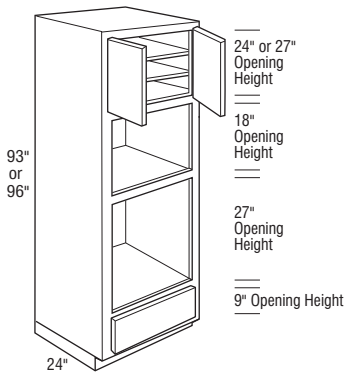

Specify appliance opening dimensions:

OMC _AC Microwave/Single Oven

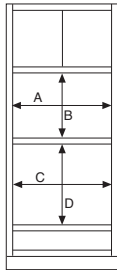

Appliance Opening Dimensions:

- A _____
- B _____
- C _____
- D _____

NOTE:

See chart for specific model appliance opening limitations.

Cabinet appliance openings may vary with modifications (i.e. clipped corner modification reduces maximum cut-out width by 3" per clipped corner).

	Cubic Feet	1	2	3	4	5	6	7
OMC279324AC	41.3	3340	3502	3629	3828	4025	4402	4779
OMC309324AC	45.7	3976	4170	4322	4557	4800	5248	5696
OMC339324AC	50.0	4131	4335	4491	4737	4979	5448	5917
OMC369324AC	54.3	4545	4768	4938	5210	5477	5992	6507
OMC399324AC	58.7	4750	4982	5162	5446	5723	6263	6803

• Includes one adjustable shelf in upper section.

OMC279624AC	42.6	3448	3619	3741	3951	4159	4547	4935
OMC309624AC	47.1	4106	4308	4461	4704	4958	5419	5880
OMC339624AC	51.6	4304	4509	4676	4935	5186	5672	6158
OMC369624AC	56.1	4735	4964	5142	5430	5704	6241	6778
OMC399624AC	60.6	4950	5191	5375	5676	5964	6522	7080

• Includes two adjustable shelves in upper section.

• Flush ToeKick modification not available in conjunction with Wide Top Rail unless loose Flush ToeKick is specified.

Notes below apply to all products in section above:

- Specify cut-out size.
- When Beaded Inset is ordered, the cabinet should be ordered to the appropriate width using the 1/4" width modification instead of using the piece-in or cut-out applications.
- Cabinet openings are subject to change based on the cut-out. Please review the acknowledged drawing.
- Shipped with loose toe space unless Attach ToeKick or Flush ToeKick is specified.
- Increased Depths available in 1/4" increments from 24 1/4" to 30".
- Reduced Depths available in 1/4" increments from 12" to 23 3/4".
- Ordering Maximum Width Cut-out on cabinet will change end panel thickness from 1/2" to 3/8" for non-flush ends, and from 5/8" to 1/2" for flush ends.

Microwave	Standard Appliance Opening		Decreased Appliance Opening Width*		Increased Appliance Opening Width**		Appliance Opening Height***	
	Width (A)	Height (B)	Min. Width (A)	Max. Width (A)	Min. Width (A)	Max. Width (A)	Min. Height (B)	Max. Height (B)
OMC279324AC	24"	18"	12"	23 1/2"	24 1/16"	25 1/2"	14"	19 1/2"
OMC309324AC	27"	18"	15"	26 1/2"	27 1/16"	28 1/2"	14"	19 1/2"
OMC339324AC	30"	18"	18"	29 1/2"	30 1/16"	31 1/2"	14"	19 1/2"
OMC369324AC	33"	18"	21"	32 1/2"	33 1/16"	34 1/2"	14"	19 1/2"
OMC399324AC	36"	18"	24"	35 1/2"	36 1/16"	37 1/2"	14"	19 1/2"
OMC279624AC	24"	18"	12"	23 1/2"	24 1/16"	25 1/2"	14"	19 1/2"
OMC309624AC	27"	18"	15"	26 1/2"	27 1/16"	28 1/2"	14"	19 1/2"
OMC339624AC	30"	18"	18"	29 1/2"	30 1/16"	31 1/2"	14"	19 1/2"
OMC369624AC	33"	18"	21"	32 1/2"	33 1/16"	34 1/2"	14"	19 1/2"
OMC399624AC	36"	18"	24"	35 1/2"	36 1/16"	37 1/2"	14"	19 1/2"

*Decreased Appliance Opening Width can vary in 1/16" increments by piecing in frame material.

**Increased Appliance Opening Width can vary in 1/16" increments by cutting out the frame stiles.

***Appliance Opening Height could have a variance of 1/16". By changing openings, it may require the door/drawer openings to change.

Oven	Standard Appliance Opening		Decreased Appliance Opening Width*		Increased Appliance Opening Width**		Appliance Opening Height***	
	Width (C)	Height (D)	Min. Width (C)	Max. Width (C)	Min. Width (C)	Max. Width (C)	Min. Height (D)	Max. Height (D)
OMC279324AC	24"	27"	12"	23 1/2"	24 1/16"	25 1/2"	25 1/2"	32 1/2"
OMC309324AC	27"	27"	15"	26 1/2"	27 1/16"	28 1/2"	25 1/2"	32 1/2"
OMC339324AC	30"	27"	18"	29 1/2"	30 1/16"	31 1/2"	25 1/2"	32 1/2"
OMC369324AC	33"	27"	21"	32 1/2"	33 1/16"	34 1/2"	25 1/2"	32 1/2"
OMC399324AC	36"	27"	24"	35 1/2"	36 1/16"	37 1/2"	25 1/2"	32 1/2"
OMC279624AC	24"	27"	12"	23 1/2"	24 1/16"	25 1/2"	25 1/2"	32 1/2"
OMC309624AC	27"	27"	15"	26 1/2"	27 1/16"	28 1/2"	25 1/2"	32 1/2"
OMC339624AC	30"	27"	18"	29 1/2"	30 1/16"	31 1/2"	25 1/2"	32 1/2"
OMC369624AC	33"	27"	21"	32 1/2"	33 1/16"	34 1/2"	25 1/2"	32 1/2"
OMC399624AC	36"	27"	24"	35 1/2"	36 1/16"	37 1/2"	25 1/2"	32 1/2"

Door & Drawer Options

AF	CC	CG	GAMD	HC	IFHG	MC	MD	MFO	PRMD	SHMD	SPLITDR	SPLITDRWS
	✓	✓		✓	✓	✓	✓	✓	✓	✓	✓	✓

End Panel Options

AUTH	CSFPE ¹	EXBK	EXDN	FL/FR	FPE	INTGE ¹	IPE ¹
✓	✓	✓		✓	✓	✓	✓

Custom Modification Options

ADD	SHLF	ADTK	ADRW	ATTK	BVR	CBO	CCO	CFNT0	CFP	CFRMO	CLIP	CND	CSDGBK	DRWTK ²	EX	EX_OL	FLUT ³	FTK	ID	
		✓					✓	✓	✓	✓	✓	✓	✓	✓	✓	✓	✓	✓	✓	✓

IH	IW ⁴	MIP	OBRB	PFINBTMB	RD	RECTK	RH	ROSFLUT	RT	SCPDRW	TD	TKP	TVR	VTK	WS	WTCD	WTKCUP	WTR	
✓	✓	✓			✓	✓		✓	✓	✓	✓	✓	✓	✓	✓	✓	✓	✓	✓

¹ Not available when cut-out width is greater than standard.

² Not available on units over 36" wide and only available when used in conjunction with attach toeKick modification.

³ Not available with 6" fluting.

⁴ Not available on 39" wide.

IH/RH availability charts starting on page G-40.
IW/RW availability charts starting on page G-46.

BUILT-IN OVEN MICROWAVE CABINET, 102" HIGH, 24" DEEP

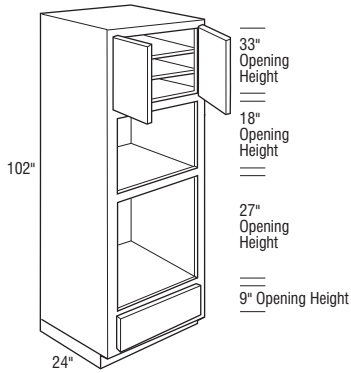

Specify appliance opening dimensions:

OMC_AC Microwave/Single Oven

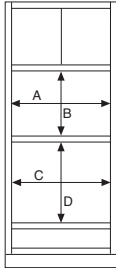

Appliance Opening Dimensions:

A _____
 B _____
 C _____
 D _____

NOTE:

See chart for specific model appliance opening limitations.

Cabinet appliance openings may vary with modifications (i.e. clipped corner modification reduces maximum cut-out width by 3" per clipped corner).

Cubic Feet	1	2	3	4	5	6	7
OMC2710224AC	61.9	6159	6396	6566	6857	7146	8222
OMC3010224AC	67.5	7072	7352	7565	7902	8254	9534
OMC3310224AC	73.1	7347	7631	7863	8222	8571	9919
OMC3610224AC	78.8	7945	8263	8510	8909	9289	10034
OMC3910224AC	84.4	8243	8578	8833	9250	9650	10424

- Specify cut-out size.
- When Beaded Inset is ordered, the cabinet should be ordered to the appropriate width using the 1/4" width modification instead of using the piece-in or cut-out applications.
- Cabinet openings are subject to change based on the cut-out. Please review the acknowledged drawing.
- Two adjustable shelves in upper section.
- Shipped with loose toe space unless Attach Toekick or Flush Toekick is specified.
- Increased Depths available in 1/4" increments from 24 1/4" to 26".
- Reduced Depths available in 1/4" increments from 12" to 23 3/4".
- Finish Flushed Ends standard.

Microwave	Standard Appliance Opening		Decreased Appliance Opening Width*		Increased Appliance Opening Width**		Appliance Opening Height***	
	Width (A)	Height (B)	Min. Width (A)	Max. Width (A)	Min. Width (A)	Max. Width (A)	Min. Height (B)	Max. Height (B)
OMC2710224AC	24"	18"	12"	23 1/2"	24 1/16"	25"	14"	19 1/2"
OMC3010224AC	27"	18"	15"	26 1/2"	27 1/16"	28"	14"	19 1/2"
OMC3310224AC	30"	18"	18"	29 1/2"	30 1/16"	31"	14"	19 1/2"
OMC3610224AC	33"	18"	21"	32 1/2"	33 1/16"	34"	14"	19 1/2"
OMC3910224AC	36"	18"	24"	35 1/2"	36 1/16"	37"	14"	19 1/2"

*Decreased Appliance Opening Width can vary in 1/16" increments by piecing in frame material.

**Increased Appliance Opening Width can vary in 1/16" increments by cutting out the frame stiles.

***Appliance Opening Height could have a variance of 1/16". By changing openings, it may require the door/drawer openings to change.

Oven	Standard Appliance Opening		Decreased Appliance Opening Width*		Increased Appliance Opening Width**		Appliance Opening Height***	
	Width (C)	Height (D)	Min. Width (C)	Max. Width (C)	Min. Width (C)	Max. Width (C)	Min. Height (D)	Max. Height (D)
OMC2710224AC	24"	27"	12"	23 1/2"	24 1/16"	25"	25 1/2"	32 1/2"
OMC3010224AC	27"	27"	15"	26 1/2"	27 1/16"	28"	25 1/2"	32 1/2"
OMC3310224AC	30"	27"	18"	29 1/2"	30 1/16"	31"	25 1/2"	32 1/2"
OMC3610224AC	33"	27"	21"	32 1/2"	33 1/16"	34"	25 1/2"	32 1/2"
OMC3910224AC	36"	27"	24"	35 1/2"	36 1/16"	37"	25 1/2"	32 1/2"

Door & Drawer Options

AF	CC	CG	GAMD	HC	IFHG	MC	MD	MFO	PRMD	SHMD ¹	SPLITDR	SPLITDRWS
✓	✓	✓	✓	✓	✓	✓	✓	✓	✓	✓	✓	✓

End Panel Options

AUTH	CSFPE	EXBK ²	EXDN	FL/FR	FPE	INTGE	IPE
✓	✓	✓	✓	✓	✓	✓	✓

Custom Modification Options

ADD_SHLF	ADDTK	ADRW	ATTK	BVR	CBO	CCO	CFNTO	CFP	CFRMO	CLIP	CND	CSDGBK	DRWTK ³	EX	EX_OL	FLUT ⁴	FTK	ID
✓	✓	✓	✓	✓	✓	✓	✓	✓	✓	✓	✓	✓	✓	✓	✓	✓	✓	✓

IH	IW ⁵	MIP	OBRB	PFINBTMB	RD	RECTK	RH	ROSLUT ⁴	RT	SCPDRW	TD	TKP	TVR	VTK	WS	WTCD	WTKCUP	WTR
✓	✓	✓	✓	✓	✓	✓	✓	✓	✓	✓	✓	✓	✓	✓	✓	✓	✓	✓

¹ Only available on top section.

² This modification will allow the end to extend back to a maximum of 30" deep.

³ Not available on units over 36" wide and only available when used in conjunction with attach toekick modification.

⁴ Not available with 6" fluting.

⁵ Not available on 39" wide.

Oven Microwave Cabinets

BUILT-IN OVEN MICROWAVE CABINET, 108" HIGH, 24" DEEP

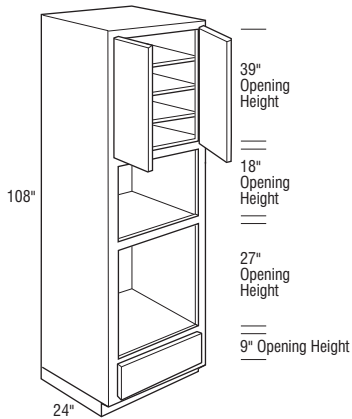

Specify appliance opening dimensions:

OMC _AC
Microwave/Single Oven

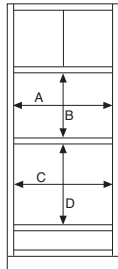

Appliance Opening Dimensions:

A _____
B _____
C _____
D _____

NOTE:

See chart for specific model appliance opening limitations.

Cabinet appliance openings may vary with modifications (i.e. clipped corner modification reduces maximum cut-out width by 3" per clipped corner).

	Cubic Feet	1	2	3	4	5	6	7
OMC2710824AC	65.3	6837	7100	7288	7611	7932	8529	9126
OMC3010824AC	71.3	7850	8161	8397	8771	9162	9872	10582
OMC3310824AC	77.2	8155	8471	8728	9127	9513	10262	11011
OMC3610824AC	83.1	8819	9171	9446	9889	10311	11138	11965
OMC3910824AC	89.1	9150	9521	9804	10268	10712	11571	12430

- Specify cut-out size.
- When Beaded Inset is ordered, the cabinet should be ordered to the appropriate width using the 1/4" width modification instead of using the piece-in or cut-out applications.
- Cabinet openings are subject to change based on the cut-out. Please review the acknowledged drawing.
- Three adjustable shelves in upper section.
- Shipped with loose toe space unless Attach Toekick or Flush Toekick is specified.
- Increased Depths available in 1/4" increments from 24 1/4" to 26".
- Reduced Depths available in 1/4" increments from 12" to 23 3/4".
- Finish Flushed Ends standard.

Microwave	Standard Appliance Opening		Decreased Appliance Opening Width*		Increased Appliance Opening Width**		Appliance Opening Height***	
	Width (A)	Height (B)	Min. Width (A)	Max. Width (A)	Min. Width (A)	Max. Width (A)	Min. Height (B)	Max. Height (B)
OMC2710824AC	24"	18"	12"	23 1/2"	24 1/16"	25"	14"	19 1/2"
OMC3010824AC	27"	18"	15"	26 1/2"	27 1/16"	28"	14"	19 1/2"
OMC3310824AC	30"	18"	18"	29 1/2"	30 1/16"	31"	14"	19 1/2"
OMC3610824AC	33"	18"	21"	32 1/2"	33 1/16"	34"	14"	19 1/2"
OMC3910824AC	36"	18"	24"	35 1/2"	36 1/16"	37"	14"	19 1/2"

*Decreased Appliance Opening Width can vary in 1/16" increments by piecing in frame material.

**Increased Appliance Opening Width can vary in 1/16" increments by cutting out the frame stiles.

***Appliance Opening Height could have a variance of 1/16". By changing openings, it may require the door/drawer openings to change.

Oven	Standard Appliance Opening		Decreased Appliance Opening Width*		Increased Appliance Opening Width**		Appliance Opening Height***	
	Width (C)	Height (D)	Min. Width (C)	Max. Width (C)	Min. Width (C)	Max. Width (C)	Min. Height (D)	Max. Height (D)
OMC2710824AC	24"	27"	12"	23 1/2"	24 1/16"	25"	25 1/2"	32 1/2"
OMC3010824AC	27"	27"	15"	26 1/2"	27 1/16"	28"	25 1/2"	32 1/2"
OMC3310824AC	30"	27"	18"	29 1/2"	30 1/16"	31"	25 1/2"	32 1/2"
OMC3610824AC	33"	27"	21"	32 1/2"	33 1/16"	34"	25 1/2"	32 1/2"
OMC3910824AC	36"	27"	24"	35 1/2"	36 1/16"	37"	25 1/2"	32 1/2"

Door & Drawer Options

AF	CC	CG	GAMD	HC	IFHG	MC	MD	MFO	PRMD	SHMD	SPLITDR	SPLITDRWS
	✓		✓		✓		✓	✓	✓	✓	✓	✓

End Panel Options

AUTH	CSFPE	EXBK ¹	EXDN	FL/ER	FPE	INTGE	IPE
✓	✓	✓		✓	✓	✓	✓

Custom Modification Options

ADD_SHLF	ADTK	ADRW	ATTK	BVR	CBO	CCO	CFNTO	CFP	CFRMO	CLIP	CND	CSDGBK	DRWTK ²	EX	EX_OL	FLUT ³	FTK	ID	
	✓		✓	✓	✓	✓	✓	✓	✓	✓	✓	✓	✓	✓	✓	✓	✓	✓	✓

IH	IW ⁴	MIP	OBRB	PFINBTMB	RD	RECTK	RH	ROSLUT ³	RT	SCPDWR	TD	TKP	TVR	VTK	WS	WTCD	WTKCUP	WTR	
✓	✓	✓	✓	✓	✓	✓	✓	✓	✓	✓	✓	✓	✓	✓	✓	✓	✓	✓	✓

¹ This modification will allow the end to extend back to a maximum of 30" deep.

² Not available on units over 36" wide and only available when used in conjunction with attach toekick modification.

³ Not available with 6" fluting.

⁴ Not available on 39" wide.

IH/RH availability charts starting on page G•40.
IW/RW availability charts starting on page G•46.

Oven Microwave Cabinets

MICROWAVE and SINGLE OVEN TRIMMABLE CABINET, 84", 87", or 90" HIGH, 24" DEEP

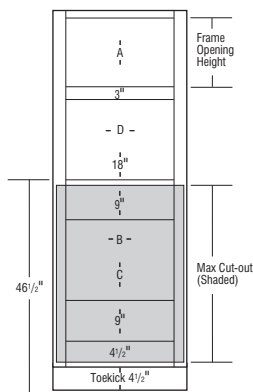
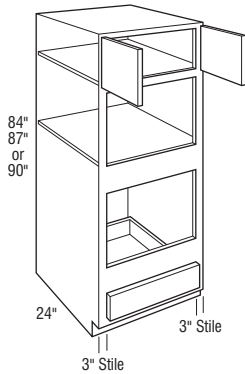

	Cubic Feet	1	2	3	4	5	6	7
OMC278424	37.4	2759	2893	2998	3165	3323	3633	3943
OMC308424	41.3	3289	3449	3570	3767	3969	4336	4703
OMC338424	45.2	3448	3619	3741	3951	4159	4547	4935
OMC368424	49.2	3791	3978	4117	4344	4576	5002	5428
OMC398424	52.4	3966	4159	4301	4544	4783	5228	5673
OMC278724	38.7	2997	3143	3256	3435	3607	3944	4281
OMC308724	42.8	3568	3741	3876	4087	4306	4704	5102
OMC338724	46.8	3704	3886	4024	4244	4466	4884	5302
OMC368724	50.9	4076	4275	4427	4669	4912	5372	5832
OMC398724	54.3	4258	4468	4628	4879	5135	5616	6097

OMC279024AH	42.6	3235	3392	3512	3704	3892	4254	4616
OMC309024AH	44.2	3847	4034	4179	4406	4641	5076	5511
OMC339024AH	48.4	3961	4156	4303	4536	4771	5218	5665
OMC369024AH	52.6	4356	4569	4734	4985	5244	5740	6236
OMC399024AH	56.1	4553	4777	4949	5212	5483	6002	6521

- AH represents upper section alignment with doors on 24" or 27" high cabinets.
- Includes one adjustable shelf in upper section.

Notes below apply to all products in section above:

- All top and bottom cross rails are 1 1/2" wide.
- Cabinet installation kit will not be included when depth is modified.
- A cabinet installation kit will be provided.
- Oven cabinet cut-out is shaded in gray and is cut out on job site.
- Designed for use with separate built-in microwave above, built-in oven below.
- For built-in double ovens, see OCD cabinets.
- Increased Heights modification will increase the height of the upper cabinet section. The bottom section will retain its original height.

	A Frame Opening Height	B Cut-out Width		C Cut-out Height		D Frame Opening Width	Door Height (Upper Section)
		Min.	Max.	Min.	Max.		Full Overlay
OMC278424	15"	21"	25 1/2"	18"	39"	21"	17 1/2"
OMC308424	15"	24"	28 1/2"	18"	39"	24"	17 1/2"
OMC338424	15"	27"	31 1/2"	18"	39"	27"	17 1/2"
OMC368424	15"	30"	34 1/2"	18"	39"	30"	17 1/2"
OMC398424	15"	33"	37 1/2"	18"	39"	33"	17 1/2"
OMC278724	18"	21"	25 1/2"	18"	39"	21"	20 1/2"
OMC308724	18"	24"	28 1/2"	18"	39"	24"	20 1/2"
OMC338724	18"	27"	31 1/2"	18"	39"	27"	20 1/2"
OMC368724	18"	30"	34 1/2"	18"	39"	30"	20 1/2"
OMC398724	18"	33"	37 1/2"	18"	39"	33"	20 1/2"
OMC279024AH	21"	21"	25 1/2"	18"	39"	21"	23 1/2"
OMC309024AH	21"	24"	28 1/2"	18"	39"	24"	23 1/2"
OMC339024AH	21"	27"	31 1/2"	18"	39"	27"	23 1/2"
OMC369024AH	21"	30"	34 1/2"	18"	39"	30"	23 1/2"
OMC399024AH	21"	33"	37 1/2"	18"	39"	33"	23 1/2"

Maximum cut-out dimension will allow 1/4" reveal for doors and drawer fronts on full overlay for trim kit face clearance.

Door & Drawer Options

AF	CC	CG	GAMD	HC	IFHG	MC	MD	MFO	PRMD	SHMD	SPLITDR	SPLITDRWS
✓	✓	✓				✓	✓	✓	✓	✓	✓	✓

End Panel Options

AUTH	CSFPE	EXBK	EXDN	FL/FR	FPE	INTGE	IPE
✓	✓	✓			✓	✓	✓

Custom Modification Options

ADD_SHLF	ADDTK	ADRW	ATTK	BVR	CBO	CCO	CFNTO	CFP	CFRMO	CLIP	CND	CSDGBK	DRWTR ¹	EX	EX_OL	FLUT ²	FTK	ID	
	✓	✓	✓	✓	✓	✓	✓	✓	✓	✓	✓	✓	✓	✓	✓	✓	✓	✓	✓
IH	IW ³	MIP	OBRB	PFINBTMB	RD	RECTK	RH	ROSLUT	RT	SCPDWR	TD	TKP	TVR	VTK	WS	WTC	WTKCUP	WTR	
✓	✓	✓	✓	✓	✓	✓	✓	✓	✓	✓	✓	✓	✓	✓	✓	✓	✓	✓	

¹ Not available on units over 36" wide.

² Not available with 6" fluting.

³ Not available on 39" wide.

Oven Microwave Cabinets

MICROWAVE and SINGLE OVEN TRIMMABLE CABINET, 93" or 96" HIGH, 24" DEEP

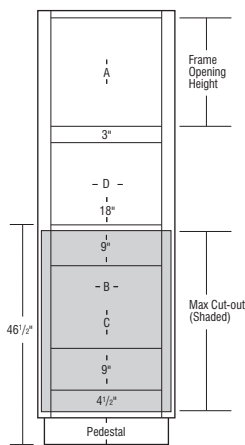
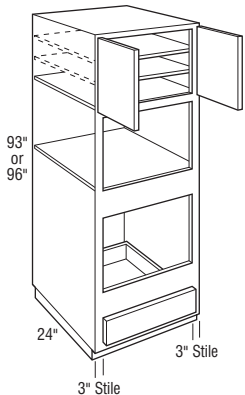

	Cubic Feet	1	2	3	4	5	6	7
OMC279324AH	41.3	3340	3502	3629	3828	4025	4402	4779
OMC309324AH	45.7	3976	4170	4322	4557	4800	5248	5696
OMC339324AH	50.0	4131	4335	4491	4737	4979	5448	5917
OMC369324AH	54.3	4545	4768	4938	5210	5477	5992	6507
OMC399324AH	57.9	4750	4982	5162	5446	5723	6263	6803

- AH represents upper section alignment with doors on 24" or 27" high cabinets.
- Includes one adjustable shelf in upper section.

OMC279624	46.2	3448	3619	3741	3951	4159	4547	4935
OMC309624	47.1	4106	4308	4461	4704	4958	5419	5880
OMC339624	51.6	4304	4509	4676	4935	5186	5672	6158
OMC369624	56.1	4735	4964	5142	5430	5704	6241	6778
OMC399624	59.8	4950	5191	5375	5676	5964	6522	7080

- Includes two adjustable shelves in upper section.
- Flush toe-kick option not available in conjunction with Wide Top Rail unless loose Flush Toe-kick is specified.

Notes below apply to all products in section above:

- Shipped with loose toe-kick unless ATTK or Flush Toe-kick is specified.
- All top and bottom cross rails are 1 1/2" wide.
- Cabinet installation kit will not be included when depth is modified.
- A cabinet installation kit will be provided.
- Oven cabinet cut-out is shaded in gray and is cut out on job site.
- Designed for use with separate built-in microwave above, built-in oven below.
- For built-in double ovens, see OCD cabinets.
- Increased Heights modification will increase the height of the upper cabinet section. The bottom section will retain its original height.

	A Frame Opening Height	B Cut-out Width		C Cut-out Height		D Frame Opening Width	Door Height (Upper Section)
		Min.	Max.	Min.	Max.		Full Overlay
OMC279324AH	24"	21"	25 1/2"	18"	39"	21"	26 1/2"
OMC309324AH	24"	24"	28 1/2"	18"	39"	24"	26 1/2"
OMC339324AH	24"	27"	31 1/2"	18"	39"	27"	26 1/2"
OMC369324AH	24"	30"	34 1/2"	18"	39"	30"	26 1/2"
OMC399324AH	24"	33"	37 1/2"	18"	39"	33"	26 1/2"
OMC279624	27"	21"	25 1/2"	18"	39"	21"	29 1/2"
OMC309624	27"	24"	28 1/2"	18"	39"	24"	29 1/2"
OMC339624	27"	27"	31 1/2"	18"	39"	27"	29 1/2"
OMC369624	27"	30"	34 1/2"	18"	39"	30"	29 1/2"
OMC399624	27"	33"	37 1/2"	18"	39"	33"	29 1/2"

Maximum cut-out dimension will allow 1/4" reveal for doors and drawer fronts on full overlay for trim kit face clearance.

Door & Drawer Options

AF	CC	CG	GAMD	HC	IFHG	MC	MD	MFO	PRMD	SHMD	SPLITDR	SPLITDRWS
✓	✓	✓	✓	✓	✓	✓	✓	✓	✓	✓	✓	✓

End Panel Options

AUTH	CSFPE	EXBK	EXDN	FL/FR	FPE	INTGE	IPE
✓	✓	✓	✓	✓	✓	✓	✓

Custom Modification Options

ADD	SHLF	ADTK	ADRW	ATTK	BVR	CBO	CCO	CFNT0	CFP	CFRMO	CLIP	CND	CSDGBK	DRWK1	EX	EX_OL	FLUT ²	FTK	ID
✓	✓	✓	✓	✓	✓	✓	✓	✓	✓	✓	✓	✓	✓	✓	✓	✓	✓	✓	✓

IH ³	IW ⁴	MIP	OBRB	PFINBTMB	RD	RECTK	RH	ROSFLUT	RT	SCPDWR	TD	TKP	TVR	VTK	WS	WTCD	WTKCUP	WTR
✓	✓	✓	✓	✓	✓	✓	✓	✓	✓	✓	✓	✓	✓	✓	✓	✓	✓	✓

¹ Not available on units over 36" wide and only available when used in conjunction with attach toe-kick modification.

² Not available with 6" fluting.

³ Not available on 96" high.

⁴ Not available on 39" wide.

IH/RH availability charts starting on page G-40.
IW/RW availability charts starting on page G-46.

Oven Microwave Cabinets

MICROWAVE and SINGLE OVEN TRIMMABLE CABINET with DEEP DRAWER, 84", 87", or 90" HIGH, 24" DEEP

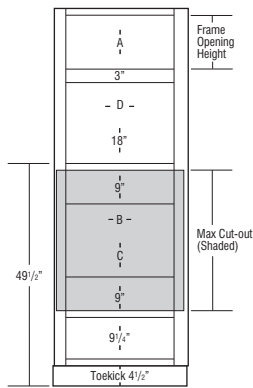
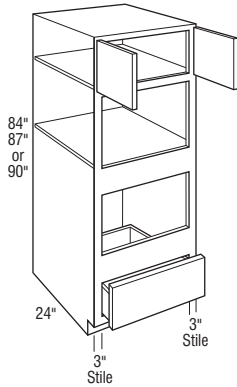

	Cubic Feet	1	2	3	4	5	6	7
OMC278424DD	37.4	3136	3290	3406	3592	3775	4128	4481
OMC308424DD	41.3	3719	3901	4040	4260	4476	4895	5314
OMC338424DD	45.2	4073	4272	4424	4665	4902	5361	5820
OMC368424DD	49.2	4580	4803	4974	5245	5512	6027	6542
OMC398424DD	53.2	5048	5295	5483	5781	6075	6644	7213
OMC278724DD	38.7	3434	3601	3729	3932	4132	4519	4906
OMC308724DD	42.8	4037	4234	4384	4623	4858	5313	5768
OMC338724DD	46.8	4473	4692	4858	5123	5384	5887	6390
OMC368724DD	50.9	5021	5266	5453	5750	6043	6608	7173
OMC398724DD	55.0	5541	5812	6018	6346	6668	7292	7916
OMC279024DD	40.0	3729	3912	4051	4271	4488	4908	5328
OMC309024DD	44.2	4351	4564	4726	4984	5237	5727	6217
OMC339024DD	48.4	4872	5110	5292	5580	5864	6412	6960
OMC369024DD	52.7	5460	5727	5930	6253	6571	7186	7801
OMC399024DD	56.9	6032	6326	6551	6908	7259	7938	8617

- All top and bottom cross rails are 1 1/2" wide.
- For built-in appliance support, OCINSTALLKIT is included in 24" deep oven cabinets.
- Oven cabinet cut-out is shaded in gray and is cut out on job site.
- Designed for use with separate built-in microwave above, built-in oven below.
- For built-in double ovens, see OCD cabinets.
- Cabinet installation kit will not be included when depth is modified.
- A cabinet installation kit will be provided.
- Increased Heights modification will increase the height of the upper cabinet section. The bottom section will retain its original height.
- Reduced Depths available in 1/4" increments from 12" to 23 3/4".

	A Frame Opening Height	B Cut-out Width		C Cut-out Height		D Frame Opening Width	Door Height (Upper Section) Full Overlay
		Min.	Max.	Min.	Max.		
OMC278424DD	12"	21"	25 1/2"	16 1/4"	31 1/4"	21"	14 1/2"
OMC308424DD	12"	24"	28 1/2"	16 1/4"	31 1/4"	24"	14 1/2"
OMC338424DD	12"	27"	31 1/2"	16 1/4"	31 1/4"	27"	14 1/2"
OMC368424DD	12"	30"	34 1/2"	16 1/4"	31 1/4"	30"	14 1/2"
OMC398424DD	12"	33"	37 1/2"	16 1/4"	31 1/4"	33"	14 1/2"
OMC278724DD	15"	21"	25 1/2"	16 1/4"	31 1/4"	21"	17 1/2"
OMC308724DD	15"	24"	28 1/2"	16 1/4"	31 1/4"	24"	17 1/2"
OMC338724DD	15"	27"	31 1/2"	16 1/4"	31 1/4"	27"	17 1/2"
OMC368724DD	15"	30"	34 1/2"	16 1/4"	31 1/4"	30"	17 1/2"
OMC398724DD	15"	33"	37 1/2"	16 1/4"	31 1/4"	33"	17 1/2"
OMC279024DD	18"	21"	25 1/2"	16 1/4"	31 1/4"	21"	20 1/2"
OMC309024DD	18"	24"	28 1/2"	16 1/4"	31 1/4"	24"	20 1/2"
OMC339024DD	18"	27"	31 1/2"	16 1/4"	31 1/4"	27"	20 1/2"
OMC369024DD	18"	30"	34 1/2"	16 1/4"	31 1/4"	30"	20 1/2"
OMC399024DD	18"	33"	37 1/2"	16 1/4"	31 1/4"	33"	20 1/2"

Maximum cut-out dimension will allow 1/4" reveal for doors and drawer fronts for trim kit face clearance.

Door & Drawer Options

AF	CC	CG	GAMD	HC	IFHG	MC	MD	MFO	PRMD	SHMD	SPLITDR	SPLITDRWS
✓	✓	✓	✓	✓	✓	✓	✓	✓	✓	✓	✓	✓

End Panel Options

AUTH	CSFPE	EXBK	EXDN	FL/FR	FPE	INTGE	IPE
✓	✓	✓	✓	✓	✓	✓	✓

Custom Modification Options

ADD_SHLF	ADDTK	ADRW	ATTK	BVR	CBO	CCO	CFNTO	CFP	CFRMO	CLIP	CND	CSDGBX	DRWTK ¹	EX	EX_OL	FLUT ²	FTK	ID	
✓	✓	✓	✓	✓	✓	✓	✓	✓	✓	✓	✓	✓	✓	✓	✓	✓	✓	✓	✓

IH	IW ³	MIP	OBRB	PFINBTMB	RD	RECTK	RH	ROSFLUT	RT	SCPDRW	TD	TKP	TVR	VTK	WS	WTC	WTKCUP	WTR	
✓	✓	✓	✓	✓	✓	✓	✓	✓	✓	✓	✓	✓	✓	✓	✓	✓	✓	✓	✓

¹ Not available on units over 36" wide.

² Not available with 6" fluting.

³ Not available on 39" wide.

Oven Microwave Cabinets

MICROWAVE and SINGLE OVEN TRIMMABLE CABINET with DEEP DRAWER, 93" or 96" HIGH, 24" DEEP

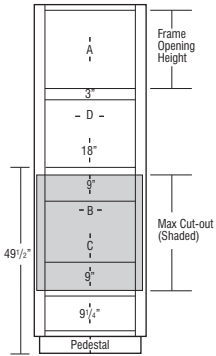
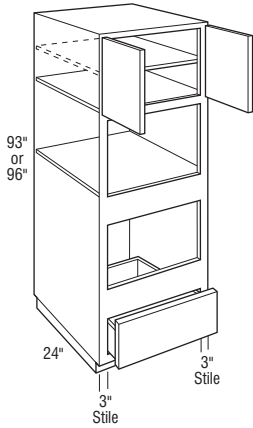

	Cubic Feet	1	2	3	4	5	6	7
OMC279324DDAH	41.3	4325	4537	4698	4954	5206	5693	6180
OMC309324DDAH	45.7	4981	5224	5410	5704	5994	6555	7116
OMC339324DDAH	50.0	5670	5947	6158	6493	6823	7462	8101
OMC369324DDAH	54.4	6336	6646	6882	7256	7626	8339	9052
OMC399324DDAH	58.7	7008	7351	7612	8026	8434	9224	10014
OMC279624DDAH	42.6	4325	4537	4698	4954	5206	5693	6180
OMC309624DDAH	47.1	4981	5224	5410	5704	5994	6555	7116
OMC339624DDAH	51.6	5670	5947	6158	6493	6823	7462	8101
OMC369624DDAH	56.1	6336	6646	6882	7256	7626	8339	9052
OMC399624DDAH	60.6	7008	7351	7612	8026	8434	9224	10014

- AH represents upper section alignment with doors on 24" or 27" high cabinets.
- Includes one adjustable shelf in upper section.
- Shipped with loose toekick unless ATTK or Flush ToeKick is specified.
- On the 96" high, flush toeKick option not available in conjunction with Wide Top Rail unless loose Flush ToeKick is specified.
- All top and bottom cross rails are 1 1/2" wide.
- For built-in appliance support, OCINSTALLKIT is included in 24" deep oven cabinets.
- Oven cabinet cut-out is shaded in gray and is cut out on job site.
- Designed for use with separate built-in microwave above, built-in oven below.
- For built-in double ovens, see OCD cabinets.
- Cabinet installation kit will not be included when depth is modified.
- A cabinet installation kit will be provided.
- Increased Heights modification will increase the height of the upper cabinet section. The bottom section will retain its original height.
- Reduced Depths available in 1/4" increments from 12" to 23 3/4".

	A Frame Opening Height	B Cut-out Width		C Cut-out Height		D Frame Opening Width	Door Height (Upper Section) Full Overlay
		Min.	Max.	Min.	Max.		
OMC279324DDAH	21"	21"	25 1/2"	16 1/4"	31 1/4"	21"	23 1/2"
OMC309324DDAH	21"	24"	28 1/2"	16 1/4"	31 1/4"	24"	23 1/2"
OMC339324DDAH	21"	27"	31 1/2"	16 1/4"	31 1/4"	27"	23 1/2"
OMC369324DDAH	21"	30"	34 1/2"	16 1/4"	31 1/4"	30"	23 1/2"
OMC399324DDAH	21"	33"	37 1/2"	16 1/4"	31 1/4"	33"	23 1/2"
OMC279624DDAH	24"	21"	25 1/2"	16 1/4"	31 1/4"	21"	26 1/2"
OMC309624DDAH	24"	24"	28 1/2"	16 1/4"	31 1/4"	24"	26 1/2"
OMC339624DDAH	24"	27"	31 1/2"	16 1/4"	31 1/4"	27"	26 1/2"
OMC369624DDAH	24"	30"	34 1/2"	16 1/4"	31 1/4"	30"	26 1/2"
OMC399624DDAH	24"	33"	37 1/2"	16 1/4"	31 1/4"	33"	26 1/2"

Maximum cut-out dimension will allow 1/4" reveal for doors and drawer fronts for trim kit face clearance.

Door & Drawer Options

AF	CC	CG	GAMD	HC	IFHG	MC	MD	MFO	PRMD	SHMD	SPLITDR	SPLITDRWS
✓	✓	✓	✓	✓	✓	✓	✓	✓	✓	✓	✓	✓

End Panel Options

AUTH	CSFPE	EXBK	EXDN	FL/FR	FPE	INTGE	IPE
✓	✓	✓	✓	✓	✓	✓	✓

Custom Modification Options

ADD_SHLF	ADDTK	ADRW	ATTK	BVR	CBO	CCO	CFNTD	CFP	CFRMO	CLIP	CND	CSDGBK	DRWK ¹	EX	EX_QL	FLUT ²	FTK	ID	
✓	✓	✓	✓	✓	✓	✓	✓	✓	✓	✓	✓	✓	✓	✓	✓	✓	✓	✓	✓

IH ³	IW ⁴	MIP	OBRB	PFINBTMB	RD	RECTK	RH	ROSFLUT	RT	SCPDRW	TD	TKP	TVR	VTK	WS	WTCD	WTKCUP	WTR	
✓	✓	✓	✓	✓	✓	✓	✓	✓	✓	✓	✓	✓	✓	✓	✓	✓	✓	✓	✓

¹ Not available on units over 36" wide and only available when used in conjunction with attach toeKick modification.

² Not available with 6" fluting.

³ Not available on 96" high.

⁴ Not available on 39" wide.

IH/RH availability charts starting on page G•40.
IW/RW availability charts starting on page G•46.

BUILT-IN SINGLE OVEN CABINET with DRAWERS, 84", 87", or 90" HIGH, 24" DEEP

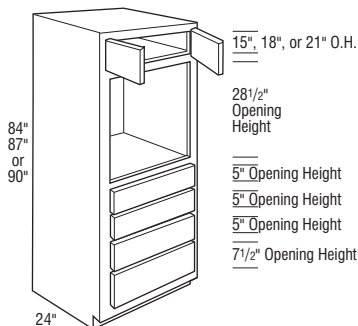

Specify appliance opening dimensions:

OCSD_ _AC Single Oven with Drawers

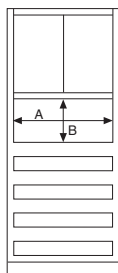

Appliance Opening Dimensions:

A _____
B _____

NOTE:

See chart for specific model appliance opening limitations.

Cabinet appliance openings may vary with modifications (i.e. clipped corner modification reduces maximum cut-out width by 3" per clipped corner).

	Cubic Feet	1	2	3	4	5	6	7
OCSD278424AC	37.4	3302	3460	3580	3778	4024	4400	4776
OCSD308424AC	41.3	3618	3784	3923	4137	4359	4761	5163
OCSD338424AC	45.2	4120	4318	4359	4557	4998	5400	5802
OCSD368424AC	49.2	4534	4747	4793	5012	5496	5941	6386
OCSD398424AC	53.1	4740	4966	5012	5239	5746	6209	6672
OCSD278724AC	38.7	3438	3601	3704	3909	4244	4597	4950
OCSD308724AC	42.8	3761	3943	4080	4304	4544	4965	5386
OCSD338724AC	46.8	4194	4395	4498	4728	5105	5547	5989
OCSD368724AC	50.9	4612	4832	4949	5199	5617	6100	6583
OCSD398724AC	55.0	4822	5057	5174	5432	5870	6382	6894
OCSD279024AC	40.0	3570	3742	3830	4041	4459	4795	5131
OCSD309024AC	44.2	3903	4098	4242	4475	4731	5166	5601
OCSD339024AC	48.4	4263	4469	4639	4892	5213	5696	6179
OCSD369024AC	52.6	4691	4916	5102	5383	5736	6263	6790
OCSD399024AC	56.8	4902	5140	5337	5628	5998	6549	7100

- Specify cut-out size.
- When Beaded Inset is ordered, the cabinet should be ordered to the appropriate width using the 1/4" width modification instead of using the piece-in or cut-out applications.
- Cabinet openings are subject to change based on the cut-out. Please review the acknowledged drawing.
- 90" high includes one adjustable shelf in upper section.
- Increased Depths available in 1/4" increments from 24 1/4" to 30".
- Reduced Depths available in 1/4" increments from 12" to 23 3/4".
- Ordering Maximum Width Cut-out on cabinet will change end panel thickness from 1/2" to 3/8" for non-flush ends, and from 5/8" to 1/2" for flush ends.

	Standard Appliance Opening		Decreased Appliance Opening Width*		Increased Appliance Opening Width**		Appliance Opening Height***	
	Width (A)	Height (B)	Min. Width (A)	Max. Width (A)	Min. Width (A)	Max. Width (A)	Min. Height (B)	Max. Height (B)
OCSD278424AC	24"	28 1/2"	12"	23 1/2"	24 1/16"	25 1/2"	27"	32 1/2"
OCSD308424AC	27"	28 1/2"	15"	26 1/2"	27 1/16"	28 1/2"	27"	32 1/2"
OCSD338424AC	30"	28 1/2"	18"	29 1/2"	30 1/16"	31 1/2"	27"	32 1/2"
OCSD368424AC	33"	28 1/2"	21"	32 1/2"	33 1/16"	34 1/2"	27"	32 1/2"
OCSD398424AC	36"	28 1/2"	24"	35 1/2"	36 1/16"	37 1/2"	27"	32 1/2"
OCSD278724AC	24"	28 1/2"	12"	23 1/2"	24 1/16"	25 1/2"	27"	32 1/2"
OCSD308724AC	27"	28 1/2"	15"	26 1/2"	27 1/16"	28 1/2"	27"	32 1/2"
OCSD338724AC	30"	28 1/2"	18"	29 1/2"	30 1/16"	31 1/2"	27"	32 1/2"
OCSD368724AC	33"	28 1/2"	21"	32 1/2"	33 1/16"	34 1/2"	27"	32 1/2"
OCSD398724AC	36"	28 1/2"	24"	35 1/2"	36 1/16"	37 1/2"	27"	32 1/2"
OCSD279024AC	24"	28 1/2"	12"	23 1/2"	24 1/16"	25 1/2"	27"	32 1/2"
OCSD309024AC	27"	28 1/2"	15"	26 1/2"	27 1/16"	28 1/2"	27"	32 1/2"
OCSD339024AC	30"	28 1/2"	18"	29 1/2"	30 1/16"	31 1/2"	27"	32 1/2"
OCSD369024AC	33"	28 1/2"	21"	32 1/2"	33 1/16"	34 1/2"	27"	32 1/2"
OCSD399024AC	36"	28 1/2"	24"	35 1/2"	36 1/16"	37 1/2"	27"	32 1/2"

*Decreased Appliance Opening Width can vary in 1/16" increments by piecing in frame material.

**Increased Appliance Opening Width can vary in 1/16" increments by cutting out the frame stiles.

***Appliance Opening Height could have a variance of 1/16". By changing openings, it may require the door/drawer openings to change.

Door & Drawer Options

AF	CC	CG	GAMD	HC	IFHG	MC	MD	MFO	PRMD	SHMD	SPLITDR	SPLITDRWS
✓	✓	✓	✓	✓	✓	✓	✓	✓	✓	✓	✓	✓

End Panel Options

AUTH	CSFP ¹	EXBK	EXDN	FL/FR	FPE	INTGE ¹	IPE ¹
✓	✓	✓	✓	✓	✓	✓	✓

Custom Modification Options

ADD_SHLF	ADDTK	ADRW	ATTK	BVR	CBO	CCO	CFNT0	CFP	CFRMO	CLIP	CND	CSDGBK	DRWTK ²	EX	EX_OL	FLUT ³	FTK	ID	
✓	✓	✓	✓	✓	✓	✓	✓	✓	✓	✓	✓	✓	✓	✓	✓	✓	✓	✓	✓

IH	IW ⁴	MIP	ORBR	PFINBTMB	RD	RECTK	RH	ROSFLUT	RT	SCPDRW	TD	TKP	TVR	VTK	WS	WTCD	WTKCUP	WTR	
✓	✓	✓	✓	✓	✓	✓	✓	✓	✓	✓	✓	✓	✓	✓	✓	✓	✓	✓	✓

¹ Not available when cut-out width is greater than standard.

² Not available on units over 36" wide.

³ Not available with 6" fluting.

⁴ Not available on 39" wide.

Oven Cabinets

BUILT-IN SINGLE OVEN CABINET with DRAWERS, 93" or 96" HIGH, 24" DEEP

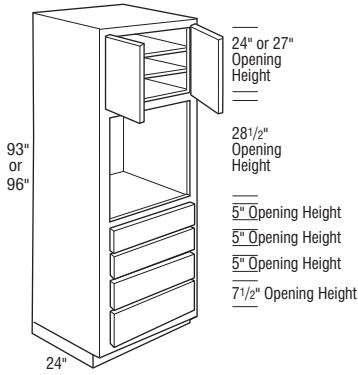

Specify appliance opening dimensions:

OCS_ _AC Single Oven with Drawers

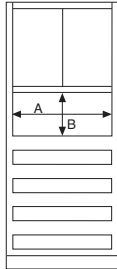

Appliance Opening Dimensions:

A _____
B _____

NOTE:

See chart for specific model appliance opening limitations.

Cabinet appliance openings may vary with modifications (i.e. clipped corner modification reduces maximum cut-out width by 3" per clipped corner).

	Cubic Feet	1	2	3	4	5	6	7
OCS279324AC	41.3	3692	3869	3985	4202	4541	4924	5307
OCS2309324AC	45.7	4083	4286	4440	4682	4958	5419	5880
OCS2339324AC	50.0	4447	4666	4831	5097	5448	5949	6450
OCS2369324AC	54.3	4892	5131	5312	5608	5993	6546	7099
OCS2399324AC	58.7	5116	5364	5557	5863	6267	6845	7423
OCS279624AC	42.6	3811	3991	4140	4366	4622	5049	5476
OCS2309624AC	47.1	4260	4468	4638	4891	5182	5672	6162
OCS2339624AC	51.6	4634	4858	5025	5302	5678	6205	6732
OCS2369624AC	56.1	5095	5340	5527	5831	6246	6826	7406
OCS2399624AC	60.6	5330	5586	5778	6094	6530	7135	7740

• Includes one adjustable shelf in upper section.

• Includes two adjustable shelves in upper section.
• Flush ToeKick modification not available in conjunction with Wide Top Rail, unless loose Flush ToeKick is specified.

Notes below apply to all products in section above:

- Specify cut-out size.
- When Beaded Inset is ordered, the cabinet should be ordered to the appropriate width using the 1/4" width modification instead of using the piece-in or cut-out applications.
- Cabinet openings are subject to change based on the cut-out. Please review the acknowledged drawing.
- Shipped with loose toe space unless Attach ToeKick or Flush ToeKick is specified.
- Increased Depths available in 1/4" increments from 24 1/4" to 30".
- Reduced Depths available in 1/4" increments from 12" to 23 3/4".
- Ordering Maximum Width Cut-out on cabinet will change end panel thickness from 1/2" to 3/8" for non-flush ends, and from 5/8" to 1/2" for flush ends.

	Standard Appliance Opening		Decreased Appliance Opening Width*		Increased Appliance Opening Width**		Appliance Opening Height***	
	Width (A)	Height (B)	Min. Width (A)	Max. Width (A)	Min. Width (A)	Max. Width (A)	Min. Height (B)	Max. Height (B)
OCS279324AC	24"	28 1/2"	12"	23 1/2"	24 1/16"	25 1/2"	27"	32 1/2"
OCS2309324AC	27"	28 1/2"	15"	26 1/2"	27 1/16"	28 1/2"	27"	32 1/2"
OCS2339324AC	30"	28 1/2"	18"	29 1/2"	30 1/16"	31 1/2"	27"	32 1/2"
OCS2369324AC	33"	28 1/2"	21"	32 1/2"	33 1/16"	34 1/2"	27"	32 1/2"
OCS2399324AC	36"	28 1/2"	24"	35 1/2"	36 1/16"	37 1/2"	27"	32 1/2"
OCS279624AC	24"	28 1/2"	12"	23 1/2"	24 1/16"	25 1/2"	27"	32 1/2"
OCS2309624AC	27"	28 1/2"	15"	26 1/2"	27 1/16"	28 1/2"	27"	32 1/2"
OCS2339624AC	30"	28 1/2"	18"	29 1/2"	30 1/16"	31 1/2"	27"	32 1/2"
OCS2369624AC	33"	28 1/2"	21"	32 1/2"	33 1/16"	34 1/2"	27"	32 1/2"
OCS2399624AC	36"	28 1/2"	24"	35 1/2"	36 1/16"	37 1/2"	27"	32 1/2"

*Decreased Appliance Opening Width can vary in 1/16" increments by piecing in frame material.

**Increased Appliance Opening Width can vary in 1/16" increments by cutting out the frame stiles.

***Appliance Opening Height could have a variance of 1/16". By changing openings, it may require the door/drawer openings to change.

Door & Drawer Options

AF	CC	CG	GAMD	HC	IFHG	MC	MD	MFO	PRMD	SHMD	SPLITDR	SPLITDRWS
✓	✓	✓	✓	✓	✓	✓	✓	✓	✓	✓	✓	✓

End Panel Options

AUTH	CSFPE ¹	EXBK	EXDN	FL/FR	FPE	INTGE ¹	IPE ¹
✓	✓	✓	✓	✓	✓	✓	✓

Custom Modification Options

ADD	SHLF	ADTK	ADRW	ATTK	BVR	CBO	CCO	CFNTD	CFP	CFRMO	CLIP	CND	CSDGBK	DRWTK ²	EX	EX_OL	FLUT ³	FTK	ID
✓	✓	✓	✓	✓	✓	✓	✓	✓	✓	✓	✓	✓	✓	✓	✓	✓	✓	✓	✓

IH	IW ⁴	MIP	OBRB	PFINBTMB	RD	RECTK	RH	ROSLUT	RT	SCPDRW	TD	TKP	TVR	VTK	WS	WTCD	WTKCUP	WTR
✓	✓	✓	✓	✓	✓	✓	✓	✓	✓	✓	✓	✓	✓	✓	✓	✓	✓	✓

¹ Not available when cut-out width is greater than standard.

² Not available on units over 36" wide when used in conjunction with attach toeKick modification.

³ Not available with 6" fluting.

⁴ Not available on 39" wide.

IH/RH availability charts starting on page G•40.
IW/RW availability charts starting on page G•46.

BUILT-IN SINGLE OVEN CABINET with DRAWERS, 102" HIGH, 24" DEEP

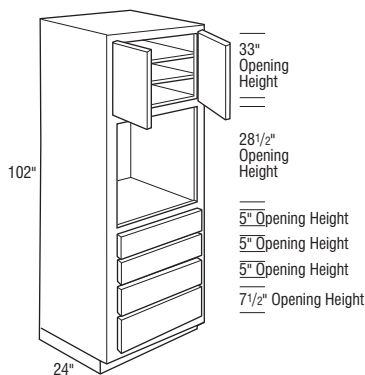

Specify appliance opening dimensions:

OCS*_AC Single Oven with Drawers

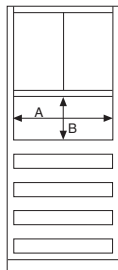

Appliance Opening Dimensions:

A _____
B _____

NOTE:

See chart for specific model appliance opening limitations.

Cabinet appliance openings may vary with modifications (i.e. clipped corner modification reduces maximum cut-out width by 3" per clipped corner).

	Cubic Feet	1	2	3	4	5	6	7
OCS*2710224AC	61.9	6663	6913	7119	7433	7788	8380	8972
OCS*3010224AC	67.5	7286	7574	7810	8161	8565	9245	9925
OCS*3310224AC	73.1	7805	8115	8347	8732	9253	9984	10715
OCS*3610224AC	78.8	8444	8784	9044	9466	10041	10846	11651
OCS*3910224AC	84.4	8770	9126	9392	9830	10435	11275	12115

- Specify cut-out size.
- When Beaded Inset is ordered, the cabinet should be ordered to the appropriate width using the 1/4" width modification instead of using the piece-in or cut-out applications.
- Cabinet openings are subject to change based on the cut-out. Please review the acknowledged drawing.
- Two adjustable shelves in upper section.
- Shipped with loose toe space unless Attach Toekick or Flush Toekick is specified.
- Increased Depths available in 1/4" increments from 24 1/4" to 26".
- Reduced Depths available in 1/4" increments from 12" to 23 3/4".
- Finish Flushed Ends standard.

	Standard Appliance Opening		Decreased Appliance Opening Width*		Increased Appliance Opening Width**		Appliance Opening Height***	
	Width (A)	Height (B)	Min. Width (A)	Max. Width (A)	Min. Width (A)	Max. Width (A)	Min. Height (B)	Max. Height (B)
OCS*2710224AC	24"	28 1/2"	12"	23 1/2"	24 1/16"	25"	27"	32 1/2"
OCS*3010224AC	27"	28 1/2"	15"	26 1/2"	27 1/16"	28"	27"	32 1/2"
OCS*3310224AC	30"	28 1/2"	18"	29 1/2"	30 1/16"	31"	27"	32 1/2"
OCS*3610224AC	33"	28 1/2"	21"	32 1/2"	33 1/16"	34"	27"	32 1/2"
OCS*3910224AC	36"	28 1/2"	24"	35 1/2"	36 1/16"	37"	27"	32 1/2"

*Decreased Appliance Opening Width can vary in 1/16" increments by piecing in frame material.

**Increased Appliance Opening Width can vary in 1/16" increments by cutting out the frame stiles.

***Appliance Opening Height could have a variance of 1/16". By changing openings, it may require the door/drawer openings to change.

Door & Drawer Options

AF	CC	CG	GAMD	HC	IFHG	MC	MD	MFO	PRMD	SHMD	SPLITDR	SPLITDRWS
✓	✓	✓	✓	✓	✓	✓	✓	✓	✓	✓	✓	✓

End Panel Options

AUTH	CSFPE	EXBK ¹	EXDN	FL/FR	FPE	INTGE	IPE
✓	✓	✓	✓	✓	✓	✓	✓

Custom Modification Options

ADD	SHLF	ADDTK	ADRW	ATTK	BVR	CBO	CCO	CFNTO	CFP	CFRMO	CLIP	CND	CSDGBK	DRWTK ²	EX	EX_OL	FLUT ³	FTK	ID
✓	✓	✓	✓	✓	✓	✓	✓	✓	✓	✓	✓	✓	✓	✓	✓	✓	✓	✓	✓

IH	IW ⁴	MIP	OBRB	PFINBTMB	RD	RECTK	RH	ROSLUT ³	RT	SCPDRW	TD	TKP	TVR	VTK	WS	WTC	WTKCUP	WTR	
✓	✓	✓	✓	✓	✓	✓	✓	✓	✓	✓	✓	✓	✓	✓	✓	✓	✓	✓	✓

¹ This modification will allow the end to extend back to a maximum of 30" deep.

² Not available on units over 36" wide and only available when used in conjunction with attach toekick modification.

³ Not available with 6" fluting.

⁴ Not available on 39" wide.

Oven Cabinets

BUILT-IN SINGLE OVEN CABINET with DRAWERS, 108" HIGH, 24" DEEP

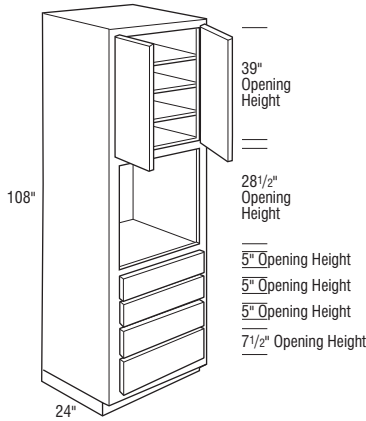

Specify appliance opening dimensions:

OCSD_ _AC
Single Oven with Drawers

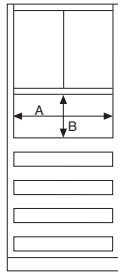

Appliance Opening Dimensions:

A _____
B _____

NOTE:

See chart for specific model appliance opening limitations.

Cabinet appliance openings may vary with modifications (i.e. clipped corner modification reduces maximum cut-out width by 3" per clipped corner).

	Cubic Feet	1	2	3	4	5	6	7
OCSD2710824AC	65.3	7396	7673	7902	8250	8645	9302	9959
OCSD3010824AC	71.3	8087	8408	8669	9059	9507	10262	11017
OCSD3310824AC	77.2	8663	9008	9265	9692	10271	11083	11895
OCSD3610824AC	83.1	9373	9751	10039	10507	11146	12039	12932
OCSD3910824AC	89.1	9735	10129	10425	10912	11583	12515	13447

- Specify cut-out size.
- When Beaded Inset is ordered, the cabinet should be ordered to the appropriate width using the 1/4" width modification instead of using the piece-in or cut-out applications.
- Cabinet openings are subject to change based on the cut-out. Please review the acknowledged drawing.
- Three adjustable shelves in upper section.
- Shipped with loose toe space unless Attach Toekick or Flush Toekick is specified.
- Increased Depths available in 1/4" increments from 24 1/4" to 26".
- Reduced Depths available in 1/4" increments from 12" to 23 3/4".
- Finish Flushed Ends standard.

	Standard Appliance Opening		Decreased Appliance Opening Width*		Increased Appliance Opening Width**		Appliance Opening Height***	
	Width (A)	Height (B)	Min. Width (A)	Max. Width (A)	Min. Width (A)	Max. Width (A)	Min. Height (B)	Max. Height (B)
OCSD2710824AC	24"	28 1/2"	12"	23 1/2"	24 1/16"	25"	27"	32 1/2"
OCSD3010824AC	27"	28 1/2"	15"	26 1/2"	27 1/16"	28"	27"	32 1/2"
OCSD3310824AC	30"	28 1/2"	18"	29 1/2"	30 1/16"	31"	27"	32 1/2"
OCSD3610824AC	33"	28 1/2"	21"	32 1/2"	33 1/16"	34"	27"	32 1/2"
OCSD3910824AC	36"	28 1/2"	24"	35 1/2"	36 1/16"	37"	27"	32 1/2"

*Decreased Appliance Opening Width can vary in 1/16" increments by piecing in frame material.

**Increased Appliance Opening Width can vary in 1/16" increments by cutting out the frame stiles.

***Appliance Opening Height could have a variance of 1/16". By changing openings, it may require the door/drawer openings to change.

Door & Drawer Options

AF	CC	CG	GAMD	HC	IFHG	MC	MD	MFO	PRMD	SHMD	SPLITDR	SPLITDRWS
✓	✓	✓	✓	✓	✓	✓	✓	✓	✓	✓		

End Panel Options

AUTH	CSFPE	EXBK ¹	EXDN	FL/FR	FPE	INTGE	IPE
✓		✓		✓			✓

Custom Modification Options

ADD	SHLF	ADDTK	ADRW	ATTK	BVR	CBO	CCO	CFNTO	CFP	CFRMO	CLIP	CND	CSDGBK	DRWTK ²	EX	EX_OL	FLUT ³	FTK	ID	
				✓		✓	✓	✓	✓	✓	✓	✓	✓	✓	✓	✓	✓	✓	✓	✓

IH	IW ⁴	MIP	OBRB	PFINBTMB	RD	RECTK	RH	ROSFLUT ³	RT	SCDRW	TD	TKP	TVR	VTK	WS	WTCD	WTKCUP	WTR	
✓	✓	✓	✓	✓	✓	✓	✓	✓	✓	✓	✓	✓	✓	✓	✓	✓	✓	✓	✓

¹ This modification will allow the end to extend back to a maximum of 30" deep.

² Not available on units over 36" wide and only available when used in conjunction with attach toekick modification.

³ Not available with 6" fluting.

⁴ Not available on 39" wide.

IH/RH availability charts starting on page G•40.
IW/RW availability charts starting on page G•46.

DOUBLE OVEN TRIMMABLE CABINET, 84", 87", or 90" HIGH, 24" DEEP

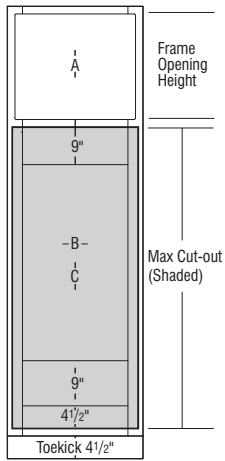
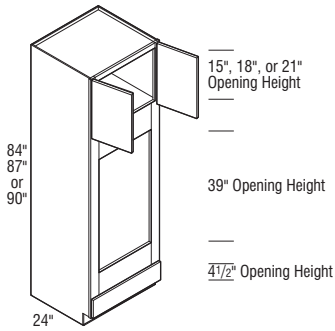

	Cubic Feet	1	2	3	4	5	6	7
OCD278424	37.0	2559	2681	2785	2938	3079	3363	3647
OCD308424	40.8	3010	3166	3277	3459	3636	3973	4310
OCD338424	44.7	3675	3855	3994	4218	4437	4848	5259
OCD368424	48.6	4044	4242	4397	4638	4880	5335	5790
OCD398424	52.4	4226	4435	4596	4846	5099	5576	6053
OCD278724	38.3	2708	2834	2938	3100	3251	3556	3861
OCD308724	42.3	3187	3346	3465	3654	3842	4201	4560
OCD338724	46.3	3834	4024	4168	4397	4634	5063	5492
OCD368724	50.3	4221	4427	4584	4833	5094	5569	6044
OCD398724	54.3	4408	4629	4793	5058	5328	5820	6312
OCD279024AH	39.6	2852	2986	3093	3267	3426	3742	4058
OCD309024AH	43.7	3363	3527	3650	3848	4051	4429	4807
OCD339024AH	47.8	3992	4191	4340	4576	4827	5276	5725
OCD369024AH	52.0	4394	4607	4774	5033	5307	5803	6299
OCD399024AH	56.1	4593	4819	4991	5264	5548	6065	6582

- AH represents upper section alignment with doors on 24" or 27" high cabinets.
- 90" high includes one adjustable shelf in upper section.
- For built-in double oven applications, remove drawer as needed.
- All top and bottom cross rails are 1 1/2" wide.
- Cabinet installation kit will not be included when depth is modified.
- A cabinet installation kit will be provided.
- Oven cabinet cut-out is shaded in gray and is cut out on job site.
- Increased Heights modification will increase the height of the upper cabinet section. The bottom section will retain its original height.

	A Frame Opening Height	B Cut-out Width		C Cut-out Height		Door Height (Upper Section)
		Min.	Max.	Min.	Max.	Full Overlay
OCD278424	15"	21"	25 1/2"	39"	60"	17 9/16"
OCD308424	15"	24"	28 1/2"	39"	60"	17 9/16"
OCD338424	15"	27"	31 1/2"	39"	60"	17 9/16"
OCD368424	15"	30"	34 1/2"	39"	60"	17 9/16"
OCD398424	15"	33"	37 1/2"	39"	60"	17 9/16"
OCD278724	18"	21"	25 1/2"	39"	60"	20 9/16"
OCD308724	18"	24"	28 1/2"	39"	60"	20 9/16"
OCD338724	18"	27"	31 1/2"	39"	60"	20 9/16"
OCD368724	18"	30"	34 1/2"	39"	60"	20 9/16"
OCD398724	18"	33"	37 1/2"	39"	60"	20 9/16"
OCD279024AH	21"	21"	25 1/2"	39"	60"	23 9/16"
OCD309024AH	21"	24"	28 1/2"	39"	60"	23 9/16"
OCD339024AH	21"	27"	31 1/2"	39"	60"	23 9/16"
OCD369024AH	21"	30"	34 1/2"	39"	60"	23 9/16"
OCD399024AH	21"	33"	37 1/2"	39"	60"	23 9/16"

Maximum cut-out dimension will allow 1/4" reveal for doors and drawer fronts on full overlay for trim kit face clearance.

Door & Drawer Options

AF	CC	CG	GAMD	IHC	IFHG	MC	MD	MFO	PRMD	SHMD	SPLITDR	SPLITDRWS
	✓	✓		✓		✓	✓	✓	✓	✓	✓	✓

End Panel Options

AUTH	CSFPE	EXBK	EXDN	FL/FR	FPE	INTGE	IPE
✓	✓	✓			✓	✓	✓

Custom Modification Options

ADD	SHLF	ADTK	ADRW	ATTK	BVR	CBO	CCO	CFNT0	CFP	CFRMO	CLIP	CND	CSDGBK	DRWTK ¹	EX	EX	OL	FLUT ²	FTK	ID	
											✓	✓	✓	✓	✓	✓	✓	✓	✓	✓	✓

IH	IW ³	MIP	ORBR	PFINBTMB	RD	RECTK	RH	ROSLUT	RT	SCPDRW	TD	TKP	TVR	VTK	WS	WTCD	WTKCUP	WTR
✓	✓	✓	✓		✓	✓	✓	✓	✓	✓	✓	✓	✓	✓	✓	✓	✓	✓

¹ Not available on units over 36" wide.

² Not available with 6" fluting.

³ Only available on 39" wide.

Oven Cabinets

DOUBLE OVEN TRIMMABLE CABINET, 93" or 96" HIGH, 24" DEEP

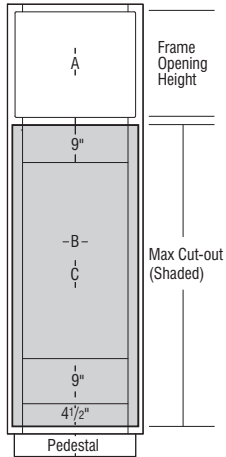
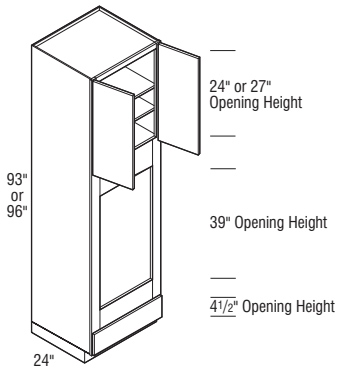

	Cubic Feet	1	2	3	4	5	6	7
OCD279324AH	40.9	3023	3170	3286	3464	3636	3973	4310
OCD309324AH	45.1	3566	3741	3875	4084	4301	4699	5097
OCD339324AH	49.4	4188	4392	4547	4796	5047	5517	5987
OCD369324AH	53.7	4606	4830	5002	5276	5552	6070	6588
OCD399324AH	57.9	4815	5049	5229	5515	5805	6346	6887

- AH represents upper section alignment with doors on 24" or 27" high cabinets.
- Upper section has one full depth adjustable shelf.

OCD279624	42.2	3189	3355	3472	3661	3847	4202	4557
OCD309624	46.6	3770	3957	4098	4320	4549	4971	5393
OCD339624	51.0	4378	4592	4755	5014	5269	5762	6255
OCD369624	55.4	4817	5049	5229	5516	5798	6338	6878
OCD399624	59.8	5035	5281	5469	5766	6059	6627	7195

- Includes two adjustable shelves in upper section.
- Flush toe-kick option not available in conjunction with Wide Top Rail unless loose Flush Toe-kick is specified.

Notes below apply to all products in section above:

- Shipped with loose toe-kick unless ATTK or Flush Toe-kick is specified.
- For built-in double oven applications, remove drawers as needed.
- All top and bottom cross rails are 1 1/2" wide.
- Cabinet installation kit will not be included when depth is modified.
- A cabinet installation kit will be provided.
- Oven cabinet cut-out is shaded in gray and is cut out on job site.
- Increased Heights modification will increase the height of the upper cabinet section. The bottom section will retain its original height.

	A Frame Opening Height	B Cut-out Width		C Cut-out Height		Door Height (Upper Section)
		Min.	Max.	Min.	Max.	Full Overlay
OCD279324AH	24"	21"	25 1/2"	39"	60"	26 9/16"
OCD309324AH	24"	24"	28 1/2"	39"	60"	26 9/16"
OCD339324AH	24"	27"	31 1/2"	39"	60"	26 9/16"
OCD369324AH	24"	30"	34 1/2"	39"	60"	26 9/16"
OCD399324AH	24"	33"	37 1/2"	39"	60"	26 9/16"
OCD279624	27"	21"	25 1/2"	39"	60"	29 9/16"
OCD309624	27"	24"	28 1/2"	39"	60"	29 9/16"
OCD339624	27"	27"	31 1/2"	39"	60"	29 9/16"
OCD369624	27"	30"	34 1/2"	39"	60"	29 9/16"
OCD399624	27"	33"	37 1/2"	39"	60"	29 9/16"

Maximum cut-out dimension will allow 1/4" reveal for doors and drawer fronts on full overlay for trim kit face clearance.

Door & Drawer Options

AF	CC	CG	GAMD	HC	IFHG	MC	MD	MFO	PRMD	SHMD	SPLITDR	SPLITDRWS
✓	✓	✓	✓	✓	✓	✓	✓	✓	✓	✓	✓	✓

End Panel Options

AUTH	CSFPE	EXBK	EXDN	FL/FR	FPE	INTGE	IPE
✓	✓	✓	✓	✓	✓	✓	✓

Custom Modification Options

ADD_SHLF	ADDTK	ADRW	ATTK	BVR	CBO	CCO	CFNTO	CFP	CFRMO	CLIP	CND	CSDGBK	DRWTK ¹	EX	EX_OL	FLUT ²	FTK	ID	
✓	✓	✓	✓	✓	✓	✓	✓	✓	✓	✓	✓	✓	✓	✓	✓	✓	✓	✓	✓

IH ³	IW ⁴	MIP	OBRB	PFINBTMB	RD	RECTK	RH	ROSFLUT	RT	SCPDRW	TD	TKP	TVR	VTK	WS	WTCD	WTKCUP	WTR	
✓	✓	✓	✓	✓	✓	✓	✓	✓	✓	✓	✓	✓	✓	✓	✓	✓	✓	✓	✓

¹ Not available on units over 36" wide and only available when used in conjunction with attach toe-kick modification.

² Not available with 6" fluting.

³ Not available on 96" high.

⁴ Not available on 39" wide.

IH/RH availability charts starting on page G•40.
IW/RW availability charts starting on page G•46.

SINGLE OVEN TRIMMABLE CABINET with DRAWERS, 84", 87", or 90" HIGH, 24" DEEP

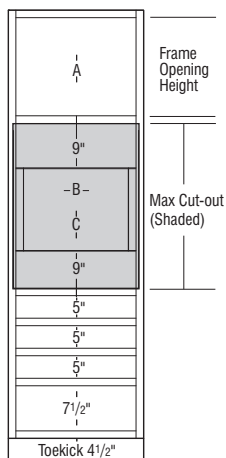
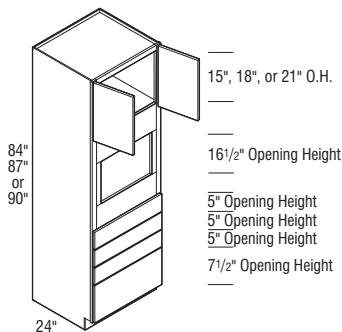

	Cubic Feet	1	2	3	4	5	6	7
OCS D278424	37.4	3302	3460	3580	3778	4024	4400	4776
OCS D308424	41.3	3618	3784	3923	4137	4359	4761	5163
OCS D338424	45.2	4120	4318	4359	4557	4998	5400	5802
OCS D368424	49.2	4534	4747	4793	5012	5496	5941	6386
OCS D398424	52.4	4740	4966	5012	5239	5746	6209	6672
OCS D278724	38.7	3438	3601	3704	3909	4244	4597	4950
OCS D308724	42.8	3761	3943	4080	4304	4544	4965	5386
OCS D338724	46.8	4194	4395	4498	4728	5105	5547	5989
OCS D368724	50.9	4612	4832	4949	5199	5617	6100	6583
OCS D398724	54.3	4822	5057	5174	5432	5870	6382	6894
OCS D279024	40.0	3570	3742	3830	4041	4459	4795	5131
OCS D309024	44.2	3903	4098	4242	4475	4731	5166	5601
OCS D339024	48.4	4263	4469	4639	4892	5213	5696	6179
OCS D369024	52.6	4691	4916	5102	5383	5736	6263	6790
OCS D399024	56.1	4902	5140	5337	5628	5998	6549	7100

- 90" high includes one full depth adjustable shelf in upper section.
- All top and bottom cross rails are 1 1/2" wide.
- Cabinet installation kit will not be included when depth is modified.

	A Frame Opening Height	B Cut-out Width		C Cut-out Height		Door Height (Upper Section) Full Overlay
		Min.	Max.	Min.	Max.	
OCS D278424	15"	21"	25"	16 1/2"	31 1/2"	17 9/16"
OCS D308424	15"	24"	28"	16 1/2"	31 1/2"	17 9/16"
OCS D338424	15"	27"	31"	16 1/2"	31 1/2"	17 9/16"
OCS D368424	15"	30"	34"	16 1/2"	31 1/2"	17 9/16"
OCS D398424	15"	33"	37"	16 1/2"	31 1/2"	17 9/16"
OCS D278724	18"	21"	25"	16 1/2"	31 1/2"	20 9/16"
OCS D308724	18"	24"	28"	16 1/2"	31 1/2"	20 9/16"
OCS D338724	18"	27"	31"	16 1/2"	31 1/2"	20 9/16"
OCS D368724	18"	30"	34"	16 1/2"	31 1/2"	20 9/16"
OCS D398724	18"	33"	37"	16 1/2"	31 1/2"	20 9/16"
OCS D279024	21"	21"	25"	16 1/2"	31 1/2"	23 9/16"
OCS D309024	21"	24"	28"	16 1/2"	31 1/2"	23 9/16"
OCS D339024	21"	27"	31"	16 1/2"	31 1/2"	23 9/16"
OCS D369024	21"	30"	34"	16 1/2"	31 1/2"	23 9/16"
OCS D399024	21"	33"	37"	16 1/2"	31 1/2"	23 9/16"

Maximum cut-out dimension will allow 1/4" reveal for doors and drawer fronts on full overlay for trim kit face clearance.

Door & Drawer Options

AF	CC	CG	GAMD	HC	IFHG	MC	MD	MFO	PRMD	SHMD	SPLITDR	SPLITDRWS
✓	✓	✓	✓	✓	✓	✓	✓	✓	✓	✓	✓	✓

End Panel Options

AUTH	CSFPE	EXBK	EXDN	FL/FR	FPE	INTGE	IPE
✓	✓	✓	✓	✓	✓	✓	✓

Custom Modification Options

ADD_SHLF	ADDTK	ADRW	ATTK	BVR	CBO	CCO	CFNT0	CFP	CFRMO	CLIP	CND	CSDGBK	DRWTK ¹	EX	EX_OL	FLUT ²	FTK	ID	
✓	✓	✓	✓	✓	✓	✓	✓	✓	✓	✓	✓	✓	✓	✓	✓	✓	✓	✓	✓

IH	IW ³	MIP	OBRB	PFINBTMB	RD	RECTK	RH	ROSLUT	RT	SCPDRW	TD	TKP	TVR	VTK	WS	WD	WTKCUP	WTR	
✓	✓	✓	✓	✓	✓	✓	✓	✓	✓	✓	✓	✓	✓	✓	✓	✓	✓	✓	✓

¹ Not available on units over 36" wide.

² Not available with 6" fluting.

³ Not available on 39" wide.

Oven Cabinets

SINGLE OVEN TRIMMABLE CABINET with DRAWERS, 93" or 96" HIGH, 24" DEEP

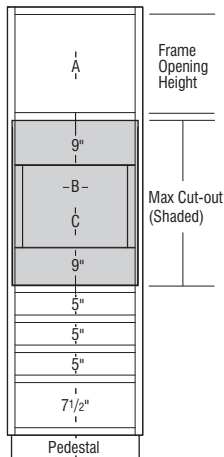
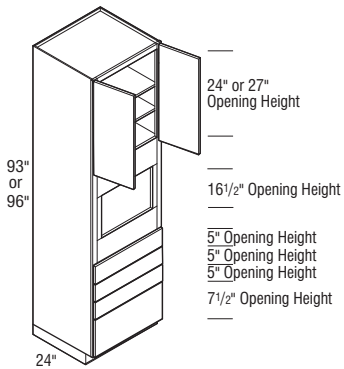

	Cubic Feet	1	2	3	4	5	6	7
OCSD279324	41.3	3692	3869	3985	4202	4541	4924	5307
OCSD309324	45.7	4083	4286	4440	4682	4958	5419	5880
OCSD339324	50.0	4447	4666	4831	5097	5448	5949	6450
OCSD369324	54.3	4892	5131	5312	5608	5993	6546	7099
OCSD399324	57.9	5116	5364	5557	5863	6267	6845	7423

• Includes one adjustable shelf in upper section.

OCSD279624	42.6	3811	3991	4140	4366	4622	5049	5476
OCSD309624	47.1	4260	4468	4638	4891	5182	5672	6162
OCSD339624	51.6	4634	4858	5025	5302	5678	6205	6732
OCSD369624	56.1	5095	5340	5527	5831	6246	6826	7406
OCSD399624	59.8	5330	5586	5778	6094	6530	7135	7740

• Includes two adjustable shelves in upper section.

• Flush toe-kick option not available in conjunction with Wide Top Rail unless loose Flush Toe-kick is specified.

Notes below apply to all products in section above:

- Shipped with loose toe-kick unless ATTK or Flush Toe-kick is specified.
- All top and bottom cross rails are 1 1/2" wide.
- Cabinet installation kit will not be included when depth is modified.

	A Frame Opening Height	B Cut-out Width		C Cut-out Height		Door Height (Upper Section) Full Overlay
		Min.	Max.	Min.	Max.	
OCSD279324	24"	21"	25"	16 1/2"	31 1/2"	26 9/16"
OCSD309324	24"	24"	28"	16 1/2"	31 1/2"	26 9/16"
OCSD339324	24"	27"	31"	16 1/2"	31 1/2"	26 9/16"
OCSD369324	24"	30"	34"	16 1/2"	31 1/2"	26 9/16"
OCSD399324	24"	33"	37"	16 1/2"	31 1/2"	26 9/16"
OCSD279624	27"	21"	25"	16 1/2"	31 1/2"	29 9/16"
OCSD309624	27"	24"	28"	16 1/2"	31 1/2"	29 9/16"
OCSD339624	27"	27"	31"	16 1/2"	31 1/2"	29 9/16"
OCSD369624	27"	30"	34"	16 1/2"	31 1/2"	29 9/16"
OCSD399624	27"	33"	37"	16 1/2"	31 1/2"	29 9/16"

Maximum cut-out dimension will allow 1/4" reveal for doors and drawer fronts on full overlay for trim kit face clearance.

Door & Drawer Options

AF	CC	CG	GAMD	HC	IFHG	MC	MD	MFO	PRMD	SHMD	SPLITDR	SPLITDRWS
✓	✓	✓		✓		✓	✓	✓	✓	✓		✓

End Panel Options

AUTH	CSFPE	EXBK	EXDN	FL/FR	FPE	INTGE	IPE
✓	✓	✓			✓	✓	✓

Custom Modification Options

ADD	SHLF	ADDTK	ADRW	ATTK	BVR	CBO	CCO	CFNTO	CFP	CFRMO	CLIP	CND	CSDGBK	DRWTK ¹	EX	EX_OL	FLUT ²	FTK	ID
				✓							✓	✓	✓	✓	✓	✓	✓	✓	✓

IH	IW	MIP	OBRB	PFINBTMB	RD	RECTK	RH	ROSLUT	RT	SCPDRW	TD	TKP	TVR	VTK	WS	WD	WTKCUP	WTR
✓	✓	✓			✓	✓	✓	✓	✓	✓	✓	✓	✓	✓	✓	✓	✓	✓

¹ Not available on units over 36" wide and only available when used in conjunction with attach toe-kick modification.

² Not available with 6" fluting.

IH/RH availability charts starting on page G-40.
IW/RW availability charts starting on page G-46.

BUILT-IN SINGLE OVEN CABINET, 84", 87", or 90" HIGH, 24" DEEP

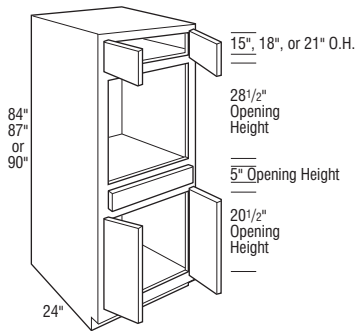

Specify appliance opening dimensions:

OCS_ _AC
Single Oven

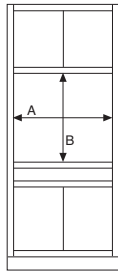

Appliance Opening Dimensions:

A _____
B _____

NOTE:

See chart for specific model appliance opening limitations.

Cabinet appliance openings may vary with modifications (i.e. clipped corner modification reduces maximum cut-out width by 3" per clipped corner).

Cubic Feet	1	2	3	4	5	6	7
OCS278424AC	37.4	3162	3318	3426	3619	3848	4568
OCS308424AC	41.3	3456	3627	3758	3961	4168	4946
OCS338424AC	45.2	3943	4132	4169	4360	4784	5548
OCS368424AC	49.2	4338	4547	4586	4796	5264	6106
OCS398424AC	53.1	4536	4750	4796	5013	5501	6387
OCS278724AC	38.7	3292	3449	3543	3739	4057	4741
OCS308724AC	42.8	3596	3775	3907	4121	4347	5149
OCS338724AC	46.8	4013	4207	4304	4525	4886	5730
OCS368724AC	50.9	4410	4630	4735	4976	5375	6311
OCS398724AC	55.0	4613	4837	4950	5204	5618	6598
OCS279024AC	40.0	3421	3582	3661	3866	4264	4908
OCS309024AC	44.2	3739	3922	4057	4287	4527	5367
OCS339024AC	48.4	4080	4282	4438	4683	4990	5914
OCS369024AC	52.6	4491	4709	4883	5153	5485	6511
OCS399024AC	56.8	4693	4924	5102	5387	5736	6804

- Specify cut-out size.
- When Beaded Inset is ordered, the cabinet should be ordered to the appropriate width using the 1/4" width modification instead of using the piece-in or cut-out applications.
- Cabinet openings are subject to change based on the cut-out. Please review the acknowledged drawing.
- 90" high includes one adjustable shelf in upper section.
- Increased Depths available in 1/4" increments from 24 1/4" to 30".
- Reduced Depths available in 1/4" increments from 12" to 23 3/4".
- Ordering Maximum Width Cut-out on cabinet will change end panel thickness from 1/2" to 3/8" for non-flush ends, and from 5/8" to 1/2" for flush ends.

	Standard Appliance Opening		Decreased Appliance Opening Width*		Increased Appliance Opening Width**		Appliance Opening Height***	
	Width (A)	Height (B)	Min. Width (A)	Max. Width (A)	Min. Width (A)	Max. Width (A)	Min. Height (B)	Max. Height (B)
OCS278424AC	24"	28 1/2"	12"	23 1/2"	24 1/16"	25 1/2"	27"	32 1/2"
OCS308424AC	27"	28 1/2"	15"	26 1/2"	27 1/16"	28 1/2"	27"	32 1/2"
OCS338424AC	30"	28 1/2"	18"	29 1/2"	30 1/16"	31 1/2"	27"	32 1/2"
OCS368424AC	33"	28 1/2"	21"	32 1/2"	33 1/16"	34 1/2"	27"	32 1/2"
OCS398424AC	36"	28 1/2"	24"	35 1/2"	36 1/16"	37 1/2"	27"	32 1/2"
OCS278724AC	24"	28 1/2"	12"	23 1/2"	24 1/16"	25 1/2"	27"	32 1/2"
OCS308724AC	27"	28 1/2"	15"	26 1/2"	27 1/16"	28 1/2"	27"	32 1/2"
OCS338724AC	30"	28 1/2"	18"	29 1/2"	30 1/16"	31 1/2"	27"	32 1/2"
OCS368724AC	33"	28 1/2"	21"	32 1/2"	33 1/16"	34 1/2"	27"	32 1/2"
OCS398724AC	36"	28 1/2"	24"	35 1/2"	36 1/16"	37 1/2"	27"	32 1/2"
OCS279024AC	24"	28 1/2"	12"	23 1/2"	24 1/16"	25 1/2"	27"	32 1/2"
OCS309024AC	27"	28 1/2"	15"	26 1/2"	27 1/16"	28 1/2"	27"	32 1/2"
OCS339024AC	30"	28 1/2"	18"	29 1/2"	30 1/16"	31 1/2"	27"	32 1/2"
OCS369024AC	33"	28 1/2"	21"	32 1/2"	33 1/16"	34 1/2"	27"	32 1/2"
OCS399024AC	36"	28 1/2"	24"	35 1/2"	36 1/16"	37 1/2"	27"	32 1/2"

*Decreased Appliance Opening Width can vary in 1/16" increments by piecing in frame material.

**Increased Appliance Opening Width can vary in 1/16" increments by cutting out the frame stiles.

***Appliance Opening Height could have a variance of 1/16". By changing openings, it may require the door/drawer openings to change.

Door & Drawer Options

AF	CC	CG	GAMD	HC	IFHG	MC	MD	MFO	PRMD	SHMD ¹	SPLITDR	SPLITDRWS
<input checked="" type="checkbox"/>	<input checked="" type="checkbox"/>	<input checked="" type="checkbox"/>	<input checked="" type="checkbox"/>	<input checked="" type="checkbox"/>	<input checked="" type="checkbox"/>	<input checked="" type="checkbox"/>	<input checked="" type="checkbox"/>	<input checked="" type="checkbox"/>	<input checked="" type="checkbox"/>	<input checked="" type="checkbox"/>	<input checked="" type="checkbox"/>	<input checked="" type="checkbox"/>

End Panel Options

AUTH	CSFPE ²	EXBK	EXDN	FL/FR	FPE	INTGE ²	IPE ²
<input checked="" type="checkbox"/>	<input checked="" type="checkbox"/>	<input checked="" type="checkbox"/>	<input checked="" type="checkbox"/>	<input checked="" type="checkbox"/>	<input checked="" type="checkbox"/>	<input checked="" type="checkbox"/>	<input checked="" type="checkbox"/>

Custom Modification Options

ADD_SHLF	ADDTK	ADRW	ATTK	BVR	CBO	CCO	CFNT0	CFP	CFRMO	CLIP	CND	CSDGBK	DRWTK ³	EX	EX_OL	FLUT ⁴	FTK	ID
<input checked="" type="checkbox"/>	<input checked="" type="checkbox"/>	<input checked="" type="checkbox"/>	<input checked="" type="checkbox"/>	<input checked="" type="checkbox"/>	<input checked="" type="checkbox"/>	<input checked="" type="checkbox"/>	<input checked="" type="checkbox"/>	<input checked="" type="checkbox"/>	<input checked="" type="checkbox"/>	<input checked="" type="checkbox"/>	<input checked="" type="checkbox"/>	<input checked="" type="checkbox"/>	<input checked="" type="checkbox"/>	<input checked="" type="checkbox"/>	<input checked="" type="checkbox"/>	<input checked="" type="checkbox"/>	<input checked="" type="checkbox"/>	<input checked="" type="checkbox"/>

IH	IW ⁵	MIP	ORBR	PFINBTMB	RD	RECTK	RH	ROSLUT	RT	SCPDWR	TD	TKP	TVR	VTK	WS	WTCID	WTKCUP	WTR
<input checked="" type="checkbox"/>	<input checked="" type="checkbox"/>	<input checked="" type="checkbox"/>	<input checked="" type="checkbox"/>	<input checked="" type="checkbox"/>	<input checked="" type="checkbox"/>	<input checked="" type="checkbox"/>	<input checked="" type="checkbox"/>	<input checked="" type="checkbox"/>	<input checked="" type="checkbox"/>	<input checked="" type="checkbox"/>	<input checked="" type="checkbox"/>	<input checked="" type="checkbox"/>	<input checked="" type="checkbox"/>	<input checked="" type="checkbox"/>	<input checked="" type="checkbox"/>	<input checked="" type="checkbox"/>	<input checked="" type="checkbox"/>	<input checked="" type="checkbox"/>

¹ Only available on top section.

² Not available when cut-out width is greater than standard.

³ Not available on units over 36" wide.

⁴ Not available with 6" fluting.

⁵ Not available on 39" wide.

Oven Cabinets

BUILT-IN SINGLE OVEN CABINET, 93" or 96" HIGH, 24" DEEP

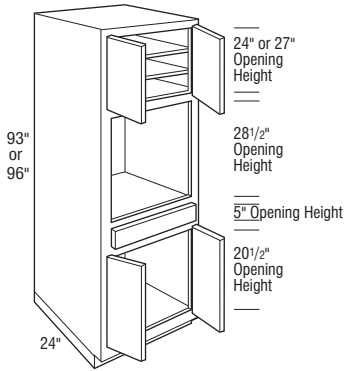

Specify appliance opening dimensions:

OCS_AC Single Oven

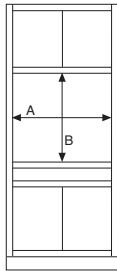

Appliance Opening Dimensions:

A _____
B _____

NOTE:

See chart for specific model appliance opening limitations.

Cabinet appliance openings may vary with modifications (i.e. clipped corner modification reduces maximum cut-out width by 3" per clipped corner).

	Cubic Feet	1	2	3	4	5	6	7
OCS279324AC	41.3	3533	3703	3811	4023	4344	4712	5080
OCS309324AC	45.7	3911	4101	4248	4486	4742	5186	5630
OCS339324AC	50.0	4256	4464	4624	4880	5211	5696	6181
OCS369324AC	54.3	4682	4911	5084	5368	5734	6267	6800
OCS399324AC	58.7	4895	5135	5312	5613	5995	6549	7103

• Includes one adjustable shelf in upper section.

OCS279624AC	42.6	3644	3825	3964	4176	4421	4836	5251
OCS309624AC	47.1	4079	4281	4437	4682	4960	5425	5890
OCS339624AC	51.6	4432	4644	4805	5074	5432	5938	6444
OCS369624AC	56.1	4876	5109	5284	5583	5979	6530	7081
OCS399624AC	60.6	5097	5341	5527	5836	6248	6827	7406

• Includes two adjustable shelves in upper section.

• Flush ToeKick modification not available in conjunction with Wide Top Rail unless loose Flush ToeKick is specified.

Notes below apply to all products in section above:

- Specify cut-out size.
- When Beaded Inset is ordered, the cabinet should be ordered to the appropriate width using the 1/4" width modification instead of using the piece-in or cut-out applications.
- Cabinet openings are subject to change based on the cut-out. Please review the acknowledged drawing.
- Shipped with loose toe space unless Attach ToeKick or Flush ToeKick is specified.
- Increased Depths available in 1/4" increments from 24 1/4" to 30".
- Reduced Depths available in 1/4" increments from 12" to 23 3/4".
- Ordering Maximum Width Cut-out on cabinet will change end panel thickness from 1/2" to 3/8" for non-flush ends, and from 5/8" to 1/2" for flush ends.

	Standard Appliance Opening		Decreased Appliance Opening Width*		Increased Appliance Opening Width**		Appliance Opening Height***	
	Width (A)	Height (B)	Min. Width (A)	Max. Width (A)	Min. Width (A)	Max. Width (A)	Min. Height (B)	Max. Height (B)
OCS279324AC	24"	28 1/2"	12"	23 1/2"	24 1/16"	25 1/2"	27"	32 1/2"
OCS309324AC	27"	28 1/2"	15"	26 1/2"	27 1/16"	28 1/2"	27"	32 1/2"
OCS339324AC	30"	28 1/2"	18"	29 1/2"	30 1/16"	31 1/2"	27"	32 1/2"
OCS369324AC	33"	28 1/2"	21"	32 1/2"	33 1/16"	34 1/2"	27"	32 1/2"
OCS399324AC	36"	28 1/2"	24"	35 1/2"	36 1/16"	37 1/2"	27"	32 1/2"
OCS279624AC	24"	28 1/2"	12"	23 1/2"	24 1/16"	25 1/2"	27"	32 1/2"
OCS309624AC	27"	28 1/2"	15"	26 1/2"	27 1/16"	28 1/2"	27"	32 1/2"
OCS339624AC	30"	28 1/2"	18"	29 1/2"	30 1/16"	31 1/2"	27"	32 1/2"
OCS369624AC	33"	28 1/2"	21"	32 1/2"	33 1/16"	34 1/2"	27"	32 1/2"
OCS399624AC	36"	28 1/2"	24"	35 1/2"	36 1/16"	37 1/2"	27"	32 1/2"

*Decreased Appliance Opening Width can vary in 1/16" increments by piecing in frame material.

**Increased Appliance Opening Width can vary in 1/16" increments by cutting out the frame stiles.

***Appliance Opening Height could have a variance of 1/16". By changing openings, it may require the door/drawer openings to change.

Door & Drawer Options

AF	CC	CG	GAMD	HC	IFHG	MC	MD	MFO	PRMD	SHMD ¹	SPLITDR	SPLITDRWS
✓	✓	✓	✓	✓	✓	✓	✓	✓	✓	✓	✓	✓

End Panel Options

AUTH	CSFPE ²	EXBK	EXDN	FL/FR	FPE	INTGE ²	IPE ²
✓	✓	✓	✓	✓	✓	✓	✓

Custom Modification Options

ADD_SHLF	ADDTK	ADRW	ATTK	BVR	CBO	CCO	CFNT0	CFP	CFRMO	CLIP	CND	CSDGBK	DRWTK ³	EX	EX_OL	FLUT ⁴	FTK	ID	
✓	✓	✓	✓	✓	✓	✓	✓	✓	✓	✓	✓	✓	✓	✓	✓	✓	✓	✓	✓

IH	IW ⁵	MIP	OBRB	PFINBTMB	RD	RECTK	RH	ROSLUT	RT	SCPDWR	TD	TKP	TVR	VTK	WS	WTCB	WTKCUP	WTR	
✓	✓	✓	✓	✓	✓	✓	✓	✓	✓	✓	✓	✓	✓	✓	✓	✓	✓	✓	✓

¹ Only available on top section.

² Not available when cut-out width is greater than standard.

³ Not available on units over 36" wide and only available when used in conjunction with attach toeKick modification.

⁴ Not available with 6" fluting.

⁵ Not available on 39" wide.

IH/RH availability charts starting on page G•40.
IW/RW availability charts starting on page G•46.

BUILT-IN SINGLE OVEN CABINET, 102" HIGH, 24" DEEP

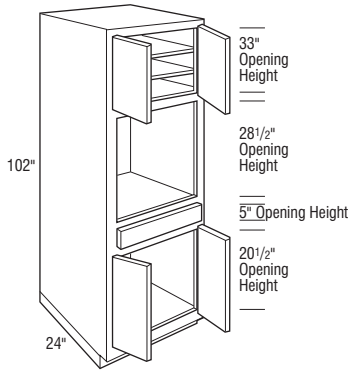

Specify appliance opening dimensions:

OCS _ AC Single Oven

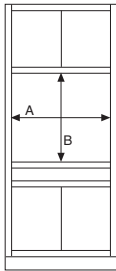

Appliance Opening Dimensions:

A _____
B _____

NOTE:

See chart for specific model appliance opening limitations.

Cabinet appliance openings may vary with modifications (i.e. clipped corner modification reduces maximum cut-out width by 3" per clipped corner).

	Cubic Feet	1	2	3	4	5	6	7
OCS2710224AC	61.9	6431	6682	6875	7169	7509	8085	8661
OCS3010224AC	67.5	7035	7315	7531	7871	8257	8902	9547
OCS3310224AC	73.1	7524	7819	8042	8415	8912	9614	10316
OCS3610224AC	78.8	8140	8464	8707	9121	9671	10435	11199
OCS3910224AC	84.4	8447	8786	9044	9472	10044	10847	11650

- Specify cut-out size.
- When Beaded Inset is ordered, the cabinet should be ordered to the appropriate width using the 1/4" width modification instead of using the piece-in or cut-out applications.
- Cabinet openings are subject to change based on the cut-out. Please review the acknowledged drawing.
- Two adjustable shelves in upper section.
- Shipped with loose toe space unless Attach Toekick or Flush Toekick is specified.
- Increased Depths available in 1/4" increments from 24 1/4" to 26".
- Reduced Depths available in 1/4" increments from 12" to 23 3/4".
- Finish Flushed Ends standard.

	Standard Appliance Opening		Decreased Appliance Opening Width*		Increased Appliance Opening Width**		Appliance Opening Height***	
	Width (A)	Height (B)	Min. Width (A)	Max. Width (A)	Min. Width (A)	Max. Width (A)	Min. Height (B)	Max. Height (B)
OCS2710224AC	24"	28 1/2"	12"	23 1/2"	24 1/16"	25"	27"	32 1/2"
OCS3010224AC	27"	28 1/2"	15"	26 1/2"	27 1/16"	28"	27"	32 1/2"
OCS3310224AC	30"	28 1/2"	18"	29 1/2"	30 1/16"	31"	27"	32 1/2"
OCS3610224AC	33"	28 1/2"	21"	32 1/2"	33 1/16"	34"	27"	32 1/2"
OCS3910224AC	36"	28 1/2"	24"	35 1/2"	36 1/16"	37"	27"	32 1/2"

*Decreased Appliance Opening Width can vary in 1/16" increments by piecing in frame material.

**Increased Appliance Opening Width can vary in 1/16" increments by cutting out the frame stiles.

***Appliance Opening Height could have a variance of 1/16". By changing openings, it may require the door/drawer openings to change.

Door & Drawer Options

AF	CC	CG	GAMD	HC	IFHG	MC	MD	MFO	PRMD	SHMD ¹	SPLITDR	SPLITDRWS
			✓		✓		✓	✓	✓	✓	✓	✓

End Panel Options

AUTH	CSFPE	EXBK ²	EXDN	FL/FR	FPE	INTGE	IPE
✓		✓		✓			✓

Custom Modification Options

ADD_SHLF	ADDTK	ADRW	ATTIK	BVR	CBO	CCO	CFNTO	CFP	CFRMO	CLIP	CND	CSDGBK	DRWTK ³	EX	EX_OL	FLUT ⁴	FTK	ID
													✓	✓	✓	✓	✓	✓
IH	IW ⁵	MIP	OBRB	PFINBTMB	RD	RECTK	RH	ROSLUT ⁴	RT	SCPDRW	TD	TKP	TVR	VTK	WS	WTCB	WTKCUP	WTR
✓	✓	✓	✓	✓	✓	✓	✓	✓	✓	✓	✓	✓	✓	✓	✓	✓	✓	✓

¹ Only available on top section.

² This modification will allow the end to extend back to a maximum of 30" deep.

³ Not available on units over 36" wide and only available when used in conjunction with attach toekick modification.

⁴ Not available with 6" fluting.

⁵ Not available on 39" wide.

Oven Cabinets

BUILT-IN SINGLE OVEN CABINET, 108" HIGH, 24" DEEP

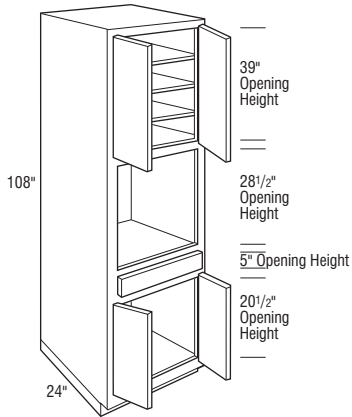

Specify appliance opening dimensions:

OCS_ AC Single Oven

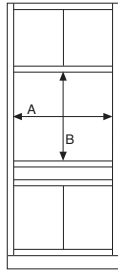

Appliance Opening Dimensions:

A _____
B _____

NOTE:

See chart for specific model appliance opening limitations.

Cabinet appliance openings may vary with modifications (i.e. clipped corner modification reduces maximum cut-out width by 3" per clipped corner).

	Cubic Feet	1	2	3	4	5	6	7
OCS2710824AC	65.3	7138	7417	7631	7958	8335	8974	9613
OCS3010824AC	71.3	7808	8120	8360	8737	9165	9881	10597
OCS3310824AC	77.2	8352	8679	8927	9341	9892	10672	11452
OCS3610824AC	83.1	9036	9395	9664	10125	10735	11583	12431
OCS3910824AC	89.1	9376	9752	10039	10514	11149	12041	12933

- Specify cut-out size.
- When Beaded Inset is ordered, the cabinet should be ordered to the appropriate width using the 1/4" width modification instead of using the piece-in or cut-out applications.
- Cabinet openings are subject to change based on the cut-out. Please review the acknowledged drawing.
- Three adjustable shelves in upper section.
- Shipped with loose toe space unless Attach Toe Kick or Flush Toe Kick is specified.
- Increased Depths available in 1/4" increments from 24 1/4" to 26".
- Reduced Depths available in 1/4" increments from 12" to 23 3/4".
- Finish Flushed Ends standard.

	Standard Appliance Opening		Decreased Appliance Opening Width*		Increased Appliance Opening Width**		Appliance Opening Height***	
	Width (A)	Height (B)	Min. Width (A)	Max. Width (A)	Min. Width (A)	Max. Width (A)	Min. Height (B)	Max. Height (B)
OCS2710824AC	24"	28 1/2"	12"	23 1/2"	24 1/16"	25"	27"	32 1/2"
OCS3010824AC	27"	28 1/2"	15"	26 1/2"	27 1/16"	28"	27"	32 1/2"
OCS3310824AC	30"	28 1/2"	18"	29 1/2"	30 1/16"	31"	27"	32 1/2"
OCS3610824AC	33"	28 1/2"	21"	32 1/2"	33 1/16"	34"	27"	32 1/2"
OCS3910824AC	36"	28 1/2"	24"	35 1/2"	36 1/16"	37"	27"	32 1/2"

*Decreased Appliance Opening Width can vary in 1/16" increments by piecing in frame material.

**Increased Appliance Opening Width can vary in 1/16" increments by cutting out the frame stiles.

***Appliance Opening Height could have a variance of 1/16". By changing openings, it may require the door/drawer openings to change.

Door & Drawer Options

AF	CC	CG	GAMD	HC	IFHG	MC	MD	MFO	PRMD	SHMD ¹	SPLITDR	SPLITDRWS
<input checked="" type="checkbox"/>	<input checked="" type="checkbox"/>	<input checked="" type="checkbox"/>	<input checked="" type="checkbox"/>	<input checked="" type="checkbox"/>	<input checked="" type="checkbox"/>	<input checked="" type="checkbox"/>	<input checked="" type="checkbox"/>	<input checked="" type="checkbox"/>	<input checked="" type="checkbox"/>	<input checked="" type="checkbox"/>	<input checked="" type="checkbox"/>	<input checked="" type="checkbox"/>

End Panel Options

AUTH	CSFPE	EXBK ²	EXDN	FL/FR	FPE	INTGE	IPE
<input checked="" type="checkbox"/>	<input checked="" type="checkbox"/>	<input checked="" type="checkbox"/>	<input checked="" type="checkbox"/>	<input checked="" type="checkbox"/>	<input checked="" type="checkbox"/>	<input checked="" type="checkbox"/>	<input checked="" type="checkbox"/>

Custom Modification Options

ADD	SHLF	ADDTK	ADRW	ATTK	BVR	CBO	CCO	CFNT0	CFP	CFRMO	CLIP	CND	CSDGBK	DRWTK ³	EX	EX_OL	FLUT ⁴	FTK	ID
<input checked="" type="checkbox"/>	<input checked="" type="checkbox"/>	<input checked="" type="checkbox"/>	<input checked="" type="checkbox"/>	<input checked="" type="checkbox"/>	<input checked="" type="checkbox"/>	<input checked="" type="checkbox"/>	<input checked="" type="checkbox"/>	<input checked="" type="checkbox"/>	<input checked="" type="checkbox"/>	<input checked="" type="checkbox"/>	<input checked="" type="checkbox"/>	<input checked="" type="checkbox"/>	<input checked="" type="checkbox"/>	<input checked="" type="checkbox"/>	<input checked="" type="checkbox"/>	<input checked="" type="checkbox"/>	<input checked="" type="checkbox"/>	<input checked="" type="checkbox"/>	<input checked="" type="checkbox"/>

IH	IW ⁵	MIP	OBRB	PFINBTMB	RD	RECTK	RH	ROSLUT ⁴	RT	SCPDWR	TD	TKP	TVR	VTK	WS	WTCD	WTKCUP	WTR
<input checked="" type="checkbox"/>	<input checked="" type="checkbox"/>	<input checked="" type="checkbox"/>	<input checked="" type="checkbox"/>	<input checked="" type="checkbox"/>	<input checked="" type="checkbox"/>	<input checked="" type="checkbox"/>	<input checked="" type="checkbox"/>	<input checked="" type="checkbox"/>	<input checked="" type="checkbox"/>	<input checked="" type="checkbox"/>	<input checked="" type="checkbox"/>	<input checked="" type="checkbox"/>	<input checked="" type="checkbox"/>	<input checked="" type="checkbox"/>	<input checked="" type="checkbox"/>	<input checked="" type="checkbox"/>	<input checked="" type="checkbox"/>	<input checked="" type="checkbox"/>

¹ Only available on top section.

² This modification will allow the end to extend back to a maximum of 30" deep.

³ Not available on units over 36" wide and only available when used in conjunction with attach toe kick modification.

⁴ Not available with 6" fluting.

⁵ Not available on 39" wide.

IH/RH availability charts starting on page G•40.
IW/RW availability charts starting on page G•46.

SINGLE OVEN TRIMMABLE CABINET, 84", 87", or 90" HIGH, 24" DEEP

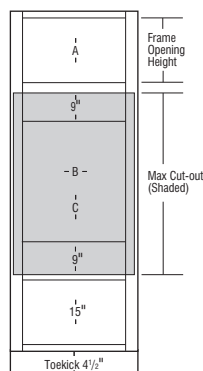
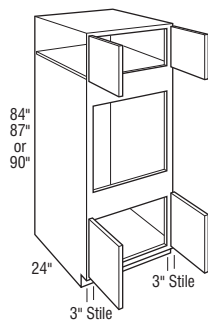

	Cubic Feet	1	2	3	4	5	6	7
OCS278424	37.4	3162	3318	3426	3619	3848	4208	4568
OCS308424	41.3	3456	3627	3758	3961	4168	4557	4946
OCS338424	45.2	3943	4132	4169	4360	4784	5166	5548
OCS368424	49.2	4338	4547	4586	4796	5264	5685	6106
OCS398424	52.4	4536	4750	4796	5013	5501	5944	6387
OCS278724	38.7	3292	3449	3543	3739	4057	4399	4741
OCS308724	42.8	3596	3775	3907	4121	4347	4748	5149
OCS338724	46.8	4013	4207	4304	4525	4886	5308	5730
OCS368724	50.9	4410	4630	4735	4976	5375	5843	6311
OCS398724	54.3	4613	4837	4950	5204	5618	6108	6598
OCS279024AH	40.0	3421	3582	3661	3866	4264	4586	4908
OCS309024AH	44.2	3739	3922	4057	4287	4527	4947	5367
OCS339024AH	48.4	4080	4282	4438	4683	4990	5452	5914
OCS369024AH	52.6	4491	4709	4883	5153	5485	5998	6511
OCS399024AH	56.1	4693	4924	5102	5387	5736	6270	6804

- AH represents upper section alignment with doors on 24" or 27" high cabinets.
- 90" high includes one adjustable shelf in upper section.
- All top and bottom cross rails are 1 1/2" wide.
- Cabinet installation kit will not be included when depth is modified.
- A cabinet installation kit will be provided.
- Oven cabinet cut-out is shaded in gray and is cut out on job site.
- Increased Heights modification will increase the height of the upper cabinet section. The bottom section will retain its original height.

	A Frame Opening Height	B Cut-out Width		C Cut-out Height		Door Height (Upper Section) Full Overlay
		Min.	Max.	Min.	Max.	
OCS278424	15"	21"	25 1/2"	28 1/2"	43 1/2"	17 1/2"
OCS308424	15"	24"	28 1/2"	28 1/2"	43 1/2"	17 1/2"
OCS338424	15"	27"	31 1/2"	28 1/2"	43 1/2"	17 1/2"
OCS368424	15"	30"	34 1/2"	28 1/2"	43 1/2"	17 1/2"
OCS398424	15"	33"	37 1/2"	28 1/2"	43 1/2"	17 1/2"
OCS278724	18"	21"	25 1/2"	28 1/2"	43 1/2"	20 1/2"
OCS308724	18"	24"	28 1/2"	28 1/2"	43 1/2"	20 1/2"
OCS338724	18"	27"	31 1/2"	28 1/2"	43 1/2"	20 1/2"
OCS368724	18"	30"	34 1/2"	28 1/2"	43 1/2"	20 1/2"
OCS398724	18"	33"	37 1/2"	28 1/2"	43 1/2"	20 1/2"
OCS279024AH	21"	21"	25 1/2"	28 1/2"	43 1/2"	23 1/2"
OCS309024AH	21"	24"	28 1/2"	28 1/2"	43 1/2"	23 1/2"
OCS339024AH	21"	27"	31 1/2"	28 1/2"	43 1/2"	23 1/2"
OCS369024AH	21"	30"	34 1/2"	28 1/2"	43 1/2"	23 1/2"
OCS399024AH	21"	33"	37 1/2"	28 1/2"	43 1/2"	23 1/2"

Maximum cut-out dimension will allow 1/4" reveal for doors and drawer fronts on full overlay for trim kit face clearance.

Door & Drawer Options

AF	CC	CG	GAMD	HC	IFHG	MC	MD	MFO	PRMD	SHMD	SPLITDR	SPLITDRWS
✓	✓	✓	✓	✓	✓	✓	✓	✓	✓	✓	✓	✓

End Panel Options

AUTH	CSFPE	EXBK	EXDN	FL/FR	FPE	INTGE	IPE
✓	✓	✓	✓	✓	✓	✓	✓

Custom Modification Options

ADD_SHLF	ADDTK	ADRW	ATTK	BVR	CBO	CCO	CFNTO	CFP	CFRMO	CLIP	CND	CSDGBK	DRWTK ¹	EX	EX_OL	FLUT ²	FTK	ID	
✓	✓	✓	✓	✓	✓	✓	✓	✓	✓	✓	✓	✓	✓	✓	✓	✓	✓	✓	✓

IH	IW ³	MIP	OBRB	PFINBTMB	RD	RECTK	RH	ROSLUT	RT	SCPDRW	TD	TKP	TVR	VTK	WS	WTCD	WTKCUP	WTR	
✓	✓	✓	✓	✓	✓	✓	✓	✓	✓	✓	✓	✓	✓	✓	✓	✓	✓	✓	✓

¹ Not available on units over 36" wide.

² Not available with 6" fluting.

³ Not available on 39" wide.

Oven Cabinets

SINGLE OVEN TRIMMABLE CABINET, 93" or 96" HIGH, 24" DEEP

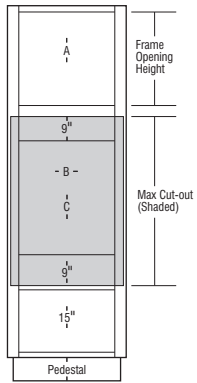
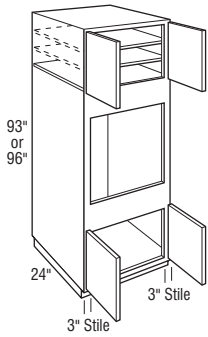

	Cubic Feet	1	2	3	4	5	6	7
OCS279324AH	41.3	3533	3703	3811	4023	4344	4712	5080
OCS309324AH	45.7	3911	4101	4248	4486	4742	5186	5630
OCS339324AH	50.0	4256	4464	4624	4880	5211	5696	6181
OCS369324AH	54.3	4682	4911	5084	5368	5734	6267	6800
OCS399324AH	57.9	4895	5135	5312	5613	5995	6549	7103

- AH represents upper section alignment with doors on 24" or 27" high cabinets.
- Includes one adjustable shelf in upper section.

OCS279624	42.6	3644	3825	3964	4176	4421	4836	5251
OCS309624	47.1	4079	4281	4437	4682	4960	5425	5890
OCS339624	51.6	4432	4644	4805	5074	5332	5938	6444
OCS369624	56.1	4876	5109	5284	5583	5979	6530	7081
OCS399624	59.3	5097	5341	5527	5836	6248	6827	7406

- Includes two adjustable shelves in upper section.
- Flush toe-kick option not available in conjunction with Wide Top Rail unless loose Flush Toe-kick is specified.

Notes below apply to all products in section above:

- Shipped with loose toe-kick unless ATTK or Flush Toe-kick is specified.
- All top and bottom cross rails are 1 1/2" wide.
- Cabinet installation kit will not be included when depth is modified.
- A cabinet installation kit will be provided.
- Oven cabinet cut-out is shaded in gray and is cut out on job site.
- Increased Heights modification will increase the height of the upper cabinet section. The bottom section will retain its original height.

	A Frame Opening Height	B Cut-out Width		C Cut-out Height		Door Height (Upper Section) Full Overlay
		Min.	Max.	Min.	Max.	
OCS279324AH	24"	21"	25 1/2"	28 1/2"	43 1/2"	26 1/2"
OCS309324AH	24"	24"	28 1/2"	28 1/2"	43 1/2"	26 1/2"
OCS339324AH	24"	27"	31 1/2"	28 1/2"	43 1/2"	26 1/2"
OCS369324AH	24"	30"	34 1/2"	28 1/2"	43 1/2"	26 1/2"
OCS399324AH	24"	33"	37 1/2"	28 1/2"	43 1/2"	26 1/2"
OCS279624	27"	21"	25 1/2"	28 1/2"	43 1/2"	29 1/2"
OCS309624	27"	24"	28 1/2"	28 1/2"	43 1/2"	29 1/2"
OCS339624	27"	27"	31 1/2"	28 1/2"	43 1/2"	29 1/2"
OCS369624	27"	30"	34 1/2"	28 1/2"	43 1/2"	29 1/2"
OCS399624	27"	33"	37 1/2"	28 1/2"	43 1/2"	29 1/2"

Maximum cut-out dimension will allow 1/4" reveal for doors and drawer fronts on full overlay for trim kit face clearance.

Door & Drawer Options

AF	CC	CG	GAMD	HC	IFHG	MC	MD	MFO	PRMD	SHMD	SPLITDR	SPLITDRWS
✓	✓	✓	✓	✓	✓	✓	✓	✓	✓	✓	✓	✓

End Panel Options

AUTH	CSFPE	EXBK	EXDN	FL/FR	FPE	INTGE	IPE
✓	✓	✓	✓	✓	✓	✓	✓

Custom Modification Options

ADD	SHLF	ADDTK	ADRW	ATTK	BVR	CBO	CCO	CFNT	CFP	CFRMO	CLIP	CND	CSDGBK	DRWTK ¹	EX	EX_OL	FLUT ²	FTK	ID
✓	✓	✓	✓	✓	✓	✓	✓	✓	✓	✓	✓	✓	✓	✓	✓	✓	✓	✓	✓

IH ³	IW ⁴	MIP	OBRB	PFINBTMB	RD	RECTK	RH	ROSFLUT	RT	SCPDRW	TD	TKP	TVR	VTK	WS	WTCO	WTKCUP	WTR
✓	✓	✓	✓	✓	✓	✓	✓	✓	✓	✓	✓	✓	✓	✓	✓	✓	✓	✓

¹ Not available on units over 36" wide and only used in conjunction with attach toe-kick modification.

² Not available with 6" fluting.

³ Not available on 96" high.

⁴ Not available on 39" wide.

IH/RH availability charts starting on page G•40.
IW/RW availability charts starting on page G•46.

SINGLE OVEN TRIMMABLE CABINET with DEEP DRAWER, 84", 87", or 90" HIGH, 24" DEEP

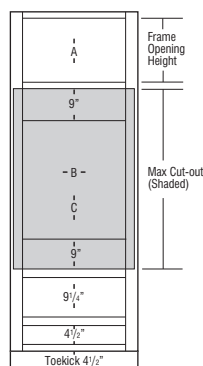
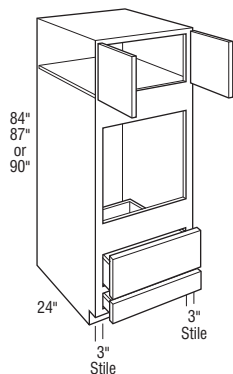

	Cubic Feet	1	2	3	4	5	6	7
OCS278424DD	37.4	3357	3521	3646	3844	4040	4418	4796
OCS308424DD	41.3	3940	4132	4279	4512	4741	5185	5629
OCS338424DD	45.2	4298	4508	4668	4922	5172	5656	6140
OCS368424DD	49.2	4806	5041	5220	5504	5784	6325	6866
OCS398424DD	53.2	5276	5534	5731	6043	6350	6944	7538
OCS278724DD	38.7	3655	3834	3970	4186	4399	4811	5223
OCS308724DD	42.8	4257	4465	4624	4876	5124	5603	6082
OCS338724DD	46.8	4697	4926	5101	5379	5652	6181	6710
OCS368724DD	50.9	5244	5501	5696	6006	6311	6902	7493
OCS398724DD	55.0	5765	6047	6261	6602	6938	7587	8236
OCS279024DDAH	40.0	3951	4144	4292	4525	4755	5200	5645
OCS309024DDAH	44.2	4572	4795	4966	5236	5502	6017	6532
OCS339024DDAH	48.4	5094	5343	5532	5834	6131	6704	7277
OCS369024DDAH	52.7	5682	5959	6171	6507	6838	7478	8118
OCS399024DDAH	56.9	6253	6559	6791	7161	7525	8230	8935

- AH represents upper section alignment with doors on 24" or 27" high cabinets.
- 90" high includes one adjustable shelf in upper section.
- All top and bottom cross rails are 1 1/2" wide.
- For built-in appliance support, OCSINSTALLKIT is included in 24" deep oven cabinets.
- Oven cabinet cut-out is shaded in gray and is cut out on job site.
- Cabinet installation kit will not be included when depth is modified.
- A cabinet installation kit will be provided.
- Increased Heights modification will increase the height of the upper cabinet section. The bottom section will retain its original height.
- Reduced Depths available in 1/4" increments from 12" to 23 3/4".

	A Frame Opening Height	B Cut-out Width		C Cut-out Height		Door Height (Upper Section)
		Min.	Max.	Min.	Max.	Full Overlay
OCS278424DD	15"	21"	25 1/2"	27 3/4"	42 3/4"	17 1/2"
OCS308424DD	15"	24"	28 1/2"	27 3/4"	42 3/4"	17 1/2"
OCS338424DD	15"	27"	31 1/2"	27 3/4"	42 3/4"	17 1/2"
OCS368424DD	15"	30"	34 1/2"	27 3/4"	42 3/4"	17 1/2"
OCS398424DD	15"	33"	37 1/2"	27 3/4"	42 3/4"	17 1/2"
OCS278724DD	18"	21"	25 1/2"	27 3/4"	42 3/4"	20 1/2"
OCS308724DD	18"	24"	28 1/2"	27 3/4"	42 3/4"	20 1/2"
OCS338724DD	18"	27"	31 1/2"	27 3/4"	42 3/4"	20 1/2"
OCS368724DD	18"	30"	34 1/2"	27 3/4"	42 3/4"	20 1/2"
OCS398724DD	18"	33"	37 1/2"	27 3/4"	42 3/4"	20 1/2"
OCS279024DDAH	21"	21"	25 1/2"	27 3/4"	42 3/4"	23 1/2"
OCS309024DDAH	21"	24"	28 1/2"	27 3/4"	42 3/4"	23 1/2"
OCS339024DDAH	21"	27"	31 1/2"	27 3/4"	42 3/4"	23 1/2"
OCS369024DDAH	21"	30"	34 1/2"	27 3/4"	42 3/4"	23 1/2"
OCS399024DDAH	21"	33"	37 1/2"	27 3/4"	42 3/4"	23 1/2"

Maximum cut-out dimension will allow 1/4" reveal for doors and drawer fronts for trim kit face clearance.

Door & Drawer Options

AF	CC	CG	GAMD	HC	IFHG	MC	MD	MFO	PRMD	SHMD	SPLITDR	SPLITDRWS
✓	✓	✓	✓	✓	✓	✓	✓	✓	✓	✓	✓	✓

End Panel Options

AUTH	CSFPE	EXBK	EXDN	FL/FR	FPE	INTGE	IPE
✓	✓	✓	✓	✓	✓	✓	✓

Custom Modification Options

ADD_SHLF	ADDTK	ADRW	ATTK	BVR	CBO	CCO	CFNTO	CFP	CFRMO	CLIP	CND	CSDGBK	DRWTK ¹	EX	EX_OL	FLUT ²	FTK	ID	
✓	✓	✓	✓	✓	✓	✓	✓	✓	✓	✓	✓	✓	✓	✓	✓	✓	✓	✓	✓

IH	IW ³	MIP	OBRB	PFINBTMB	RD	RECTK ⁴	RH	ROSLUT	RT	SCPDRW	TD	TKP ⁴	TVR	VTK ⁴	WS	WTCD	WTKUP	WTR	
✓	✓	✓	✓	✓	✓	✓	✓	✓	✓	✓	✓	✓	✓	✓	✓	✓	✓	✓	✓

¹ Not available on units over 36" wide.

² 6" fluting not available on 24" or 27" wide. Not available with 6" fluting both.

³ Not available on 39" wide.

⁴ Not available on 33" or 36" wide.

Oven Cabinets

SINGLE OVEN TRIMMABLE CABINET with DEEP DRAWER, 93" or 96" HIGH, 24" DEEP

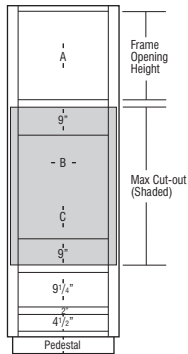
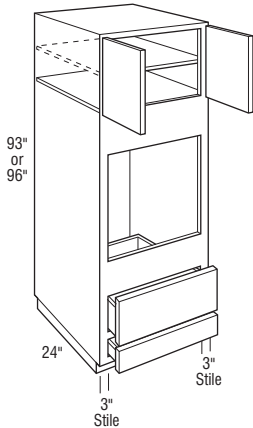

	Cubic Feet	1	2	3	4	5	6	7
OCS279324DDAH	41.3	4549	4771	4940	5209	5474	5987	6500
OCS309324DDAH	45.7	5203	5457	5651	5958	6261	6847	7433
OCS339324DDAH	50.0	5893	6181	6400	6749	7092	7756	8420
OCS369324DDAH	54.4	6559	6879	7124	7512	7894	8632	9370
OCS399324DDAH	58.7	7231	7584	7854	8281	8703	9517	10331

- AH represents upper section alignment with doors on 24" or 27" high cabinets.
- Includes one adjustable shelf in upper section.

OCS279624DD	42.6	4549	4771	4940	5209	5474	5987	6500
OCS309624DD	47.1	5203	5457	5651	5958	6261	6847	7433
OCS339624DD	51.6	5893	6181	6400	6749	7092	7756	8420
OCS369624DD	56.1	6559	6879	7124	7512	7894	8632	9370
OCS399624DD	60.6	7231	7584	7854	8281	8703	9517	10331

- Includes two adjustable shelves in upper section.
- Flush toekick option not available in conjunction with Wide Top Rail unless loose Flush ToeKick is specified.

Notes below apply to all products in section above:

- Shipped with loose toekick unless ATTK or Flush ToeKick is specified.
- All top and bottom cross rails are 1 1/2" wide.
- For built-in appliance support, OCINSTALLKIT is included in 24" deep oven cabinets.
- Oven cabinet cut-out is shaded in gray and is cut out on job site.
- Cabinet installation kit will not be included when depth is modified.
- A cabinet installation kit will be provided.
- Increased Heights modification will increase the height of the upper cabinet section. The bottom section will retain its original height.
- Reduced Depths available in 1/4" increments from 12" to 23 3/4".

	A Frame Opening Height	B Cut-out Width		C Cut-out Height		Door Height (Upper Section) Full Overlay
		Min.	Max.	Min.	Max.	
OCS279324DDAH	24"	21"	25 1/2"	27 3/4"	42 3/4"	26 1/2"
OCS309324DDAH	24"	24"	28 1/2"	27 3/4"	42 3/4"	26 1/2"
OCS339324DDAH	24"	27"	31 1/2"	27 3/4"	42 3/4"	26 1/2"
OCS369324DDAH	24"	30"	34 1/2"	27 3/4"	42 3/4"	26 1/2"
OCS399324DDAH	24"	33"	37 1/2"	27 3/4"	42 3/4"	26 1/2"
OCS279624DD	27"	21"	25 1/2"	27 3/4"	42 3/4"	29 1/2"
OCS309624DD	27"	24"	28 1/2"	27 3/4"	42 3/4"	29 1/2"
OCS339624DD	27"	27"	31 1/2"	27 3/4"	42 3/4"	29 1/2"
OCS369624DD	27"	30"	34 1/2"	27 3/4"	42 3/4"	29 1/2"
OCS399624DD	27"	33"	37 1/2"	27 3/4"	42 3/4"	29 1/2"

Maximum cut-out dimension will allow 1/4" reveal for doors and drawer fronts for trim kit face clearance.

Door & Drawer Options

AF	CC	CG	GAMD	HC	IFHG	MC	MD	MFO	PRMD	SHMD	SPLITDR	SPLITDRWS
✓	✓	✓	✓	✓	✓	✓	✓	✓	✓	✓	✓	✓

End Panel Options

AUTH	CSFPE	EXBK	EXDN	FL/FR	FPE	INTGE	IPE
✓	✓	✓	✓	✓	✓	✓	✓

Custom Modification Options

ADD	SHLF	ADTK	ADRW	ATTK	BVR	CBO	CCO	CFNTD	CFP	CFRMO	CLIP	CND	CSDGBK	DRWTK ¹	EX	EX_OL	FLUT ²	FTK	ID	
✓	✓	✓	✓	✓	✓	✓	✓	✓	✓	✓	✓	✓	✓	✓	✓	✓	✓	✓	✓	✓

IH ³	IW ⁴	MIP	OBRB	PFINBTMB	RD	RECTK	RH	ROSFLUT	RT	SCPDRW	TD	TKP	TVR	VTK	WS	WTCD	WTKCUP	WTR	
✓	✓	✓	✓	✓	✓	✓	✓	✓	✓	✓	✓	✓	✓	✓	✓	✓	✓	✓	✓

¹ Not available on units over 36" wide and only available when used in conjunction with the attach toekick modification.

² Not available with 6" fluting.

³ Not available on 96" high.

⁴ Not available on 39" wide.

IH/RH availability charts starting on page G•40.
IW/RW availability charts starting on page G•46.

BUILT-IN DOUBLE OVEN CABINET, 84", 87", or 90" HIGH, 24" DEEP

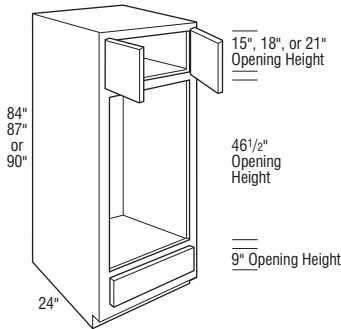

Specify appliance opening dimensions:

OCD__AC
Double Oven

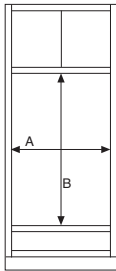

Appliance Opening Dimensions:

A _____
B _____

NOTE:

See chart for specific model appliance opening limitations.

Cabinet appliance openings may vary with modifications (i.e. clipped corner modification reduces maximum cut-out width by 3" per clipped corner).

	Cubic Feet	1	2	3	4	5	6	7
OCD278424AC	37.4	2559	2681	2785	2938	3079	3363	3647
OCD308424AC	41.3	3010	3166	3277	3459	3636	3973	4310
OCD338424AC	45.2	3675	3855	3994	4218	4437	4848	5259
OCD368424AC	49.2	4044	4242	4397	4638	4880	5335	5790
OCD398424AC	53.1	4226	4435	4596	4846	5099	5576	6053
OCD278724AC	38.7	2708	2834	2938	3100	3251	3556	3861
OCD308724AC	42.8	3187	3346	3465	3654	3842	4201	4560
OCD338724AC	46.8	3834	4024	4168	4397	4634	5063	5492
OCD368724AC	50.9	4221	4427	4584	4833	5094	5569	6044
OCD398724AC	55.0	4408	4629	4793	5058	5328	5820	6312
OCD279024AC	40.0	2852	2986	3093	3267	3426	3742	4058
OCD309024AC	44.2	3363	3527	3650	3848	4051	4429	4807
OCD339024AC	48.4	3992	4191	4340	4576	4827	5276	5725
OCD369024AC	52.6	4394	4607	4774	5033	5307	5803	6299
OCD399024AC	56.8	4593	4819	4991	5264	5548	6065	6582

- Specify cut-out size.
- When Beaded Inset is ordered, the cabinet should be ordered to the appropriate width using the 1/4" width modification instead of using the piece-in or cut-out applications.
- Cabinet openings are subject to change based on the cut-out. Please review the acknowledged drawing.
- 90" high includes one adjustable shelf in upper section.
- Increased Depths available in 1/4" increments from 24 1/4" to 30".
- Reduced Depths available in 1/4" increments from 12" to 23 3/4".
- Ordering Maximum Width Cut-out on cabinet will change end panel thickness from 1/2" to 3/8" for non-flush ends, and from 5/8" to 1/2" for flush ends.

	Standard Appliance Opening		Decreased Appliance Opening Width*		Increased Appliance Opening Width**		Appliance Opening Height***	
	Width (A)	Height (B)	Min. Width (A)	Max. Width (A)	Min. Width (A)	Max. Width (A)	Min. Height (B)	Max. Height (B)
OCD278424AC	24"	46 1/2"	12"	23 1/2"	24 1/16"	25 1/2"	40"	52"
OCD308424AC	27"	46 1/2"	15"	26 1/2"	27 1/16"	28 1/2"	40"	52"
OCD338424AC	30"	46 1/2"	18"	29 1/2"	30 1/16"	31 1/2"	40"	52"
OCD368424AC	33"	46 1/2"	21"	32 1/2"	33 1/16"	34 1/2"	40"	52"
OCD398424AC	36"	46 1/2"	24"	35 1/2"	36 1/16"	37 1/2"	40"	52"
OCD278724AC	24"	46 1/2"	12"	23 1/2"	24 1/16"	25 1/2"	40"	52"
OCD308724AC	27"	46 1/2"	15"	26 1/2"	27 1/16"	28 1/2"	40"	52"
OCD338724AC	30"	46 1/2"	18"	29 1/2"	30 1/16"	31 1/2"	40"	52"
OCD368724AC	33"	46 1/2"	21"	32 1/2"	33 1/16"	34 1/2"	40"	52"
OCD398724AC	36"	46 1/2"	24"	35 1/2"	36 1/16"	37 1/2"	40"	52"
OCD279024AC	24"	46 1/2"	12"	23 1/2"	24 1/16"	25 1/2"	40"	52"
OCD309024AC	27"	46 1/2"	15"	26 1/2"	27 1/16"	28 1/2"	40"	52"
OCD339024AC	30"	46 1/2"	18"	29 1/2"	30 1/16"	31 1/2"	40"	52"
OCD369024AC	33"	46 1/2"	21"	32 1/2"	33 1/16"	34 1/2"	40"	52"
OCD399024AC	36"	46 1/2"	24"	35 1/2"	36 1/16"	37 1/2"	40"	52"

*Decreased Appliance Opening Width can vary in 1/16" increments by piecing in frame material.

**Increased Appliance Opening Width can vary in 1/16" increments by cutting out the frame stiles.

***Appliance Opening Height could have a variance of 1/16". By changing openings, it may require the door/drawer openings to change.

Door & Drawer Options

AF	CC	CG	GAMD	HC	IFHG	MC	MD	MFO	PRMD	SHMD	SPLITDR	SPLITDRWS
<input checked="" type="checkbox"/>	<input checked="" type="checkbox"/>	<input checked="" type="checkbox"/>	<input checked="" type="checkbox"/>	<input checked="" type="checkbox"/>	<input checked="" type="checkbox"/>	<input checked="" type="checkbox"/>	<input checked="" type="checkbox"/>	<input checked="" type="checkbox"/>	<input checked="" type="checkbox"/>	<input checked="" type="checkbox"/>	<input checked="" type="checkbox"/>	<input checked="" type="checkbox"/>

End Panel Options

AUTH	CSFPE ¹	EXBK	EXDN	FL/FR	FPE	INTGE ¹	IPE ¹
<input checked="" type="checkbox"/>	<input checked="" type="checkbox"/>	<input checked="" type="checkbox"/>	<input checked="" type="checkbox"/>	<input checked="" type="checkbox"/>	<input checked="" type="checkbox"/>	<input checked="" type="checkbox"/>	<input checked="" type="checkbox"/>

Custom Modification Options

ADD_SHLF	ADDTK	ADRW	ATTIK	BVR	CBO	CCO	CFNTO	CFP	CFRMO	CLIP	CND	CSDG8K	DRWTK ²	EX	EX_OL	FLUT ³	FTK	ID
<input checked="" type="checkbox"/>	<input checked="" type="checkbox"/>	<input checked="" type="checkbox"/>	<input checked="" type="checkbox"/>	<input checked="" type="checkbox"/>	<input checked="" type="checkbox"/>	<input checked="" type="checkbox"/>	<input checked="" type="checkbox"/>	<input checked="" type="checkbox"/>	<input checked="" type="checkbox"/>	<input checked="" type="checkbox"/>	<input checked="" type="checkbox"/>	<input checked="" type="checkbox"/>	<input checked="" type="checkbox"/>	<input checked="" type="checkbox"/>	<input checked="" type="checkbox"/>	<input checked="" type="checkbox"/>	<input checked="" type="checkbox"/>	<input checked="" type="checkbox"/>

IH	IW ⁴	MIP	ORBR	PFINBTMB	RD	RECTK	RH	ROSLUT	RT	SCPDWR	TD	TKP	TVR	VTK	WS	WTC	WTKCUP	WTR
<input checked="" type="checkbox"/>	<input checked="" type="checkbox"/>	<input checked="" type="checkbox"/>	<input checked="" type="checkbox"/>	<input checked="" type="checkbox"/>	<input checked="" type="checkbox"/>	<input checked="" type="checkbox"/>	<input checked="" type="checkbox"/>	<input checked="" type="checkbox"/>	<input checked="" type="checkbox"/>	<input checked="" type="checkbox"/>	<input checked="" type="checkbox"/>	<input checked="" type="checkbox"/>	<input checked="" type="checkbox"/>	<input checked="" type="checkbox"/>	<input checked="" type="checkbox"/>	<input checked="" type="checkbox"/>	<input checked="" type="checkbox"/>	<input checked="" type="checkbox"/>

¹ Not available when cut-out width is greater than standard.

² Not available on units over 36" wide.

³ Not available with 6" fluting.

⁴ Not available on 39" wide.

Oven Cabinets

BUILT-IN DOUBLE OVEN CABINET, 93" or 96" HIGH, 24" DEEP

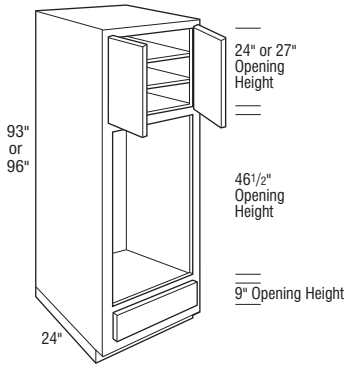

Specify appliance opening dimensions:

OCD_ _AC
Double Oven

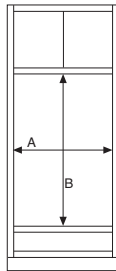

Appliance Opening Dimensions:

A _____
B _____

NOTE:

See chart for specific model appliance opening limitations.

Cabinet appliance openings may vary with modifications (i.e. clipped corner modification reduces maximum cut-out width by 3" per clipped corner).

	Cubic Feet	1	2	3	4	5	6	7
OCD279324AC	41.3	3023	3170	3286	3464	3636	3973	4310
OCD309324AC	45.7	3566	3741	3875	4084	4301	4699	5097
OCD339324AC	50.0	4188	4392	4547	4796	5047	5517	5987
OCD369324AC	54.3	4606	4830	5002	5276	5552	6070	6588
OCD399324AC	58.7	4815	5049	5229	5515	5805	6346	6887

• Includes one adjustable shelf in upper section.

OCD279624AC	42.6	3189	3355	3472	3661	3847	4202	4557
OCD309624AC	47.1	3770	3957	4098	4320	4549	4971	5393
OCD339624AC	51.6	4378	4592	4755	5014	5269	5762	6255
OCD369624AC	56.1	4817	5049	5229	5516	5798	6338	6878
OCD399624AC	60.6	5035	5281	5469	5766	6059	6627	7195

• Includes two adjustable shelves in upper section.

• Flush ToeKick option not available in conjunction with Wide Top Rail unless loose Flush ToeKick is specified.

Notes below apply to all products in section above:

- Specify cut-out size.
- When Beaded Inset is ordered, the cabinet should be ordered to the appropriate width using the 1/4" width modification instead of using the piece-in or cut-out applications.
- Cabinet openings are subject to change based on the cut-out. Please review the acknowledged drawing.
- Shipped with loose toe space unless Attach ToeKick or Flush ToeKick is specified.
- Increased Depths available in 1/4" increments from 24 1/4" to 30".
- Reduced Depths available in 1/4" increments from 12" to 23 3/4".
- Ordering Maximum Width Cut-out on cabinet will change end panel thickness from 1/2" to 3/8" for non-flush ends, and from 5/8" to 1/2" for flush ends.

	Standard Appliance Opening		Decreased Appliance Opening Width*		Increased Appliance Opening Width**		Appliance Opening Height***	
	Width (A)	Height (B)	Min. Width (A)	Max. Width (A)	Min. Width (A)	Max. Width (A)	Min. Height (B)	Max. Height (B)
OCD279324AC	24"	46 1/2"	12"	23 1/2"	24 1/16"	25 1/2"	40"	52"
OCD309324AC	27"	46 1/2"	15"	26 1/2"	27 1/16"	28 1/2"	40"	52"
OCD339324AC	30"	46 1/2"	18"	29 1/2"	30 1/16"	31 1/2"	40"	52"
OCD369324AC	33"	46 1/2"	21"	32 1/2"	33 1/16"	34 1/2"	40"	52"
OCD399324AC	36"	46 1/2"	24"	35 1/2"	36 1/16"	37 1/2"	40"	52"
OCD279624AC	24"	46 1/2"	12"	23 1/2"	24 1/16"	25 1/2"	40"	52"
OCD309624AC	27"	46 1/2"	15"	26 1/2"	27 1/16"	28 1/2"	40"	52"
OCD339624AC	30"	46 1/2"	18"	29 1/2"	30 1/16"	31 1/2"	40"	52"
OCD369624AC	33"	46 1/2"	21"	32 1/2"	33 1/16"	34 1/2"	40"	52"
OCD399624AC	36"	46 1/2"	24"	35 1/2"	36 1/16"	37 1/2"	40"	52"

*Decreased Appliance Opening Width can vary in 1/16" increments by piecing in frame material.

**Increased Appliance Opening Width can vary in 1/16" increments by cutting out the frame stiles.

***Appliance Opening Height could have a variance of 1/16". By changing openings, it may require the door/drawer openings to change.

Door & Drawer Options

AF	CC	CG	GAMD	HC	IFHG	MC	MD	MFO	PRMD	SHMD	SPLITDR	SPLITDRWS
<input checked="" type="checkbox"/>	<input checked="" type="checkbox"/>	<input checked="" type="checkbox"/>	<input checked="" type="checkbox"/>	<input checked="" type="checkbox"/>	<input checked="" type="checkbox"/>	<input checked="" type="checkbox"/>	<input checked="" type="checkbox"/>	<input checked="" type="checkbox"/>	<input checked="" type="checkbox"/>	<input checked="" type="checkbox"/>	<input checked="" type="checkbox"/>	<input checked="" type="checkbox"/>

End Panel Options

AUTH	CSFPE ¹	EXBK	EXDN	FL/FR	FPE	INTGE ¹	IPE ¹
<input checked="" type="checkbox"/>	<input checked="" type="checkbox"/>	<input checked="" type="checkbox"/>	<input checked="" type="checkbox"/>	<input checked="" type="checkbox"/>	<input checked="" type="checkbox"/>	<input checked="" type="checkbox"/>	<input checked="" type="checkbox"/>

Custom Modification Options

ADD	SHLF	ADDTK	ADRW	ATTK	BVR	CBO	CCO	CFNT0	CFP	CFRMO	CLIP	CND	CSDGBK	DRWTK ²	EX	EX_OL	FLUT ³	FTK	ID
<input checked="" type="checkbox"/>	<input checked="" type="checkbox"/>	<input checked="" type="checkbox"/>	<input checked="" type="checkbox"/>	<input checked="" type="checkbox"/>	<input checked="" type="checkbox"/>	<input checked="" type="checkbox"/>	<input checked="" type="checkbox"/>	<input checked="" type="checkbox"/>	<input checked="" type="checkbox"/>	<input checked="" type="checkbox"/>	<input checked="" type="checkbox"/>	<input checked="" type="checkbox"/>	<input checked="" type="checkbox"/>	<input checked="" type="checkbox"/>	<input checked="" type="checkbox"/>	<input checked="" type="checkbox"/>	<input checked="" type="checkbox"/>	<input checked="" type="checkbox"/>	<input checked="" type="checkbox"/>

IH	IW ⁴	MIP	OBRB	PFINBTMB	RD	RECTK	RH	ROSLUT	RT	SCPDRW	TD	TKP	TVR	VTK	WS	WTCB	WTKCUP	WTR
<input checked="" type="checkbox"/>	<input checked="" type="checkbox"/>	<input checked="" type="checkbox"/>	<input checked="" type="checkbox"/>	<input checked="" type="checkbox"/>	<input checked="" type="checkbox"/>	<input checked="" type="checkbox"/>	<input checked="" type="checkbox"/>	<input checked="" type="checkbox"/>	<input checked="" type="checkbox"/>	<input checked="" type="checkbox"/>	<input checked="" type="checkbox"/>	<input checked="" type="checkbox"/>	<input checked="" type="checkbox"/>	<input checked="" type="checkbox"/>	<input checked="" type="checkbox"/>	<input checked="" type="checkbox"/>	<input checked="" type="checkbox"/>	<input checked="" type="checkbox"/>

¹ Not available when cut-out width is greater than standard.

² Not available on units over 36" wide and only available when used in conjunction with attach toeKick modification.

³ Not available with 6" fluting.

⁴ Not available on 39" wide.

IH/RH availability charts starting on page G•40.
IW/RW availability charts starting on page G•46.

BUILT-IN DOUBLE OVEN CABINET, 102" HIGH, 24" DEEP

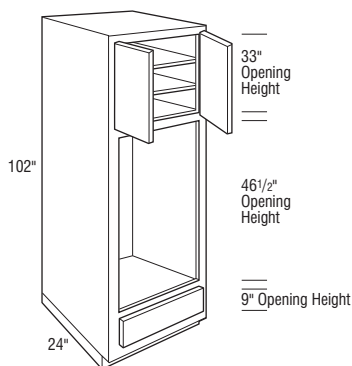

Specify appliance opening dimensions:

OCD__AC
Double Oven

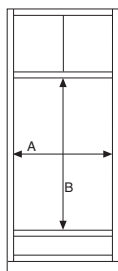

Appliance Opening Dimensions:

A _____
B _____

NOTE:

See chart for specific model appliance opening limitations.

Cabinet appliance openings may vary with modifications (i.e. clipped corner modification reduces maximum cut-out width by 3" per clipped corner).

	Cubic Feet	1	2	3	4	5	6	7
OCD2710224AC	61.9	5800	6030	6192	6455	6713	7205	7697
OCD3010224AC	67.5	6606	6865	7061	7369	7687	8272	8857
OCD3310224AC	73.1	7449	7746	7973	8332	8686	9370	10054
OCD3610224AC	78.8	8059	8380	8630	9028	9420	10169	10918
OCD3910224AC	84.4	8361	8702	8963	9375	9782	10570	11358

- Specify cut-out size.
- When Beaded Inset is ordered, the cabinet should be ordered to the appropriate width using the 1/4" width modification instead of using the piece-in or cut-out applications.
- Cabinet openings are subject to change based on the cut-out. Please review the acknowledged drawing.
- Two adjustable shelves in upper section.
- Shipped with loose toe space unless Attach Toekick or Flush Toekick is specified.
- Increased Depths available in 1/4" increments from 24 1/4" to 26".
- Reduced Depths available in 1/4" increments from 12" to 23 3/4".
- Finish Flushed Ends standard.

	Standard Appliance Opening		Decreased Appliance Opening Width*		Increased Appliance Opening Width**		Appliance Opening Height***	
	Width (A)	Height (B)	Min. Width (A)	Max. Width (A)	Min. Width (A)	Max. Width (A)	Min. Height (B)	Max. Height (B)
OCD2710224AC	24"	46 1/2"	12"	23 1/2"	24 1/16"	25"	40"	52"
OCD3010224AC	27"	46 1/2"	15"	26 1/2"	27 1/16"	28"	40"	52"
OCD3310224AC	30"	46 1/2"	18"	29 1/2"	30 1/16"	31"	40"	52"
OCD3610224AC	33"	46 1/2"	21"	32 1/2"	33 1/16"	34"	40"	52"
OCD3910224AC	36"	46 1/2"	24"	35 1/2"	36 1/16"	37"	40"	52"

*Decreased Appliance Opening Width can vary in 1/16" increments by piecing in frame material.

**Increased Appliance Opening Width can vary in 1/16" increments by cutting out the frame stiles.

***Appliance Opening Height could have a variance of 1/16". By changing openings, it may require the door/drawer openings to change.

Door & Drawer Options

AF	CC	CG	GAMD	IHC	IFHG	MC	MD	MFO	PRMD	SHMD	SPLITDR	SPLITDRWS
	✓	✓		✓		✓	✓	✓	✓	✓	✓	✓

End Panel Options

AUTH	CSFPE	EXBK ¹	EXDN	FL/FR	FPE	INTGE	IPE
✓		✓		✓			✓

Custom Modification Options

ADD	SHLF	ADTK	ADRW	ATTK	BVR	CBO	CCO	CFNTO	CFP	CFRMO	CLIP	CND	CSDG8K	DRWTK ²	EX	EX_OL	FLUT ³	FTK	ID
					✓	✓	✓	✓		✓		✓		✓	✓	✓	✓	✓	✓

IH	IW ⁴	MIP	OBRB	PFINBTMB	RD	RECTK	RH	ROSLUT ³	RT	SCPDRW	TD	TKP	TVR	VTK	WS	WTCB	WTKCUP	WTR
✓	✓		✓		✓	✓	✓	✓	✓	✓	✓	✓	✓	✓	✓	✓	✓	✓

¹ This modification will allow the end to extend back to a maximum of 30" deep.

² Not available on units over 36" wide and only available when used in conjunction with attach toekick modification.

³ Not available with 6" fluting.

⁴ Not available on 39" wide.

Oven Cabinets

BUILT-IN DOUBLE OVEN CABINET, 108" HIGH, 24" DEEP

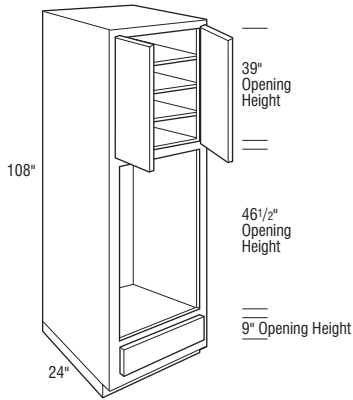

Specify appliance opening dimensions:

OCD _ _ AC
Double Oven

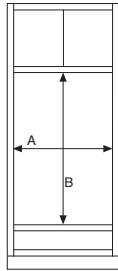

Appliance Opening Dimensions:

A _____
B _____

NOTE:

See chart for specific model appliance opening limitations.

Cabinet appliance openings may vary with modifications (i.e. clipped corner modification reduces maximum cut-out width by 3" per clipped corner).

	Cubic Feet	1	2	3	4	5	6	7
OCD2710824AC	65.3	6438	6693	6874	7165	7451	7998	8545
OCD3010824AC	71.3	7333	7621	7838	8180	8532	9182	9832
OCD3310824AC	77.2	8269	8599	8850	9248	9641	10400	11159
OCD3610824AC	83.1	8945	9302	9580	10022	10456	11288	12120
OCD3910824AC	89.1	9281	9660	9949	10407	10858	11733	12608

- Specify cut-out size.
- When Beaded Inset is ordered, the cabinet should be ordered to the appropriate width using the 1/4" width modification instead of using the piece-in or cut-out applications.
- Cabinet openings are subject to change based on the cut-out. Please review the acknowledged drawing.
- Three adjustable shelves in upper section.
- Shipped with loose toe space unless Attach Toekick or Flush Toekick is specified.
- Increased Depths available in 1/4" increments from 24 1/4" to 26".
- Reduced Depths available in 1/4" increments from 12" to 23 3/4".
- Finish Flushed Ends standard.

	Standard Appliance Opening		Decreased Appliance Opening Width*		Increased Appliance Opening Width**		Appliance Opening Height***	
	Width (A)	Height (B)	Min. Width (A)	Max. Width (A)	Min. Width (A)	Max. Width (A)	Min. Height (B)	Max. Height (B)
OCD2710824AC	24"	46 1/2"	12"	23 1/2"	24 1/16"	25"	40"	52"
OCD3010824AC	27"	46 1/2"	15"	26 1/2"	27 1/16"	28"	40"	52"
OCD3310824AC	30"	46 1/2"	18"	29 1/2"	30 1/16"	31"	40"	52"
OCD3610824AC	33"	46 1/2"	21"	32 1/2"	33 1/16"	34"	40"	52"
OCD3910824AC	36"	46 1/2"	24"	35 1/2"	36 1/16"	37"	40"	52"

*Decreased Appliance Opening Width can vary in 1/16" increments by piecing in frame material.

**Increased Appliance Opening Width can vary in 1/16" increments by cutting out the frame stiles.

***Appliance Opening Height could have a variance of 1/16". By changing openings, it may require the door/drawer openings to change.

Door & Drawer Options

AF	CC	CG	GAMD	HC	IFHG	MC	MD	MFO	PRMD	SHMD	SPLITDR	SPLITDRWS
<input checked="" type="checkbox"/>	<input checked="" type="checkbox"/>	<input checked="" type="checkbox"/>	<input checked="" type="checkbox"/>	<input checked="" type="checkbox"/>	<input checked="" type="checkbox"/>	<input checked="" type="checkbox"/>	<input checked="" type="checkbox"/>	<input checked="" type="checkbox"/>	<input checked="" type="checkbox"/>	<input checked="" type="checkbox"/>	<input checked="" type="checkbox"/>	<input checked="" type="checkbox"/>

End Panel Options

AUTH	CSFPE	EXBK ¹	EXDN	FL/FR	FPE	INTGE	IPE
<input checked="" type="checkbox"/>	<input checked="" type="checkbox"/>	<input checked="" type="checkbox"/>	<input checked="" type="checkbox"/>	<input checked="" type="checkbox"/>	<input checked="" type="checkbox"/>	<input checked="" type="checkbox"/>	<input checked="" type="checkbox"/>

Custom Modification Options

ADD	SHLF	ADDTK	ADRW	ATTK	BVR	CBO	CCO	CFNT0	CFP	CFRMO	CLIP	CND	CSDGBK	DRWTK ²	EX	EX_OL	FLUT ³	FTK	ID
<input checked="" type="checkbox"/>	<input checked="" type="checkbox"/>	<input checked="" type="checkbox"/>	<input checked="" type="checkbox"/>	<input checked="" type="checkbox"/>	<input checked="" type="checkbox"/>	<input checked="" type="checkbox"/>	<input checked="" type="checkbox"/>	<input checked="" type="checkbox"/>	<input checked="" type="checkbox"/>	<input checked="" type="checkbox"/>	<input checked="" type="checkbox"/>	<input checked="" type="checkbox"/>	<input checked="" type="checkbox"/>	<input checked="" type="checkbox"/>	<input checked="" type="checkbox"/>	<input checked="" type="checkbox"/>	<input checked="" type="checkbox"/>	<input checked="" type="checkbox"/>	<input checked="" type="checkbox"/>

IH	IW ⁴	MIP	OBRB	PFINBTMB	RD	RECTK	RH	ROSFLUT ³	RT	SCPDRW	TD	TKP	TVR	VTK	WS	WTCD	WTKCUP	WTR
<input checked="" type="checkbox"/>	<input checked="" type="checkbox"/>	<input checked="" type="checkbox"/>	<input checked="" type="checkbox"/>	<input checked="" type="checkbox"/>	<input checked="" type="checkbox"/>	<input checked="" type="checkbox"/>	<input checked="" type="checkbox"/>	<input checked="" type="checkbox"/>	<input checked="" type="checkbox"/>	<input checked="" type="checkbox"/>	<input checked="" type="checkbox"/>	<input checked="" type="checkbox"/>	<input checked="" type="checkbox"/>	<input checked="" type="checkbox"/>	<input checked="" type="checkbox"/>	<input checked="" type="checkbox"/>	<input checked="" type="checkbox"/>	<input checked="" type="checkbox"/>

¹ This modification will allow the end to extend back to a maximum of 30" deep.

² Not available on units over 36" wide and only available in conjunction with attach toekick modification.

³ Not available with 6" fluting.

⁴ Not available on 39" wide.

IH/RH availability charts starting on page G•40.
IW/RW availability charts starting on page G•46.

DOUBLE OVEN TRIMMABLE CABINET with DEEP DRAWER, 84", 87", or 90" HIGH, 24" DEEP

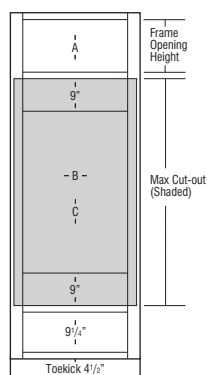
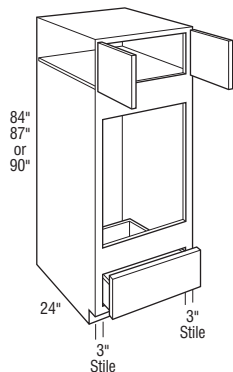

	Cubic Feet	1	2	3	4	5	6	7
OCD278424DD	37.4	3003	3150	3262	3439	3614	3952	4290
OCD308424DD	41.3	3560	3734	3866	4077	4284	4685	5086
OCD338424DD	45.2	3901	4091	4236	4467	4694	5134	5574
OCD368424DD	49.2	4385	4600	4763	5022	5278	5772	6266
OCD398424DD	53.2	4834	5070	5250	5536	5818	6362	6906
OCD278724DD	38.7	3286	3446	3569	3763	3954	4324	4694
OCD308724DD	42.8	3860	4049	4192	4421	4645	5080	5515
OCD338724DD	46.8	4283	4493	4652	4906	5155	5637	6119
OCD368724DD	50.9	4807	5042	5221	5506	5786	6327	6868
OCD398724DD	55.0	5306	5565	5763	6077	6386	6983	7580
OCD279024DD	40.0	3566	3740	3873	4084	4291	4693	5095
OCD309024DD	44.2	4159	4362	4517	4763	5005	5473	5941
OCD339024DD	48.4	4665	4893	5066	5342	5614	6139	6664
OCD369024DD	52.7	5229	5484	5679	5988	6293	6882	7471
OCD399024DD	56.9	5778	6061	6276	6618	6954	7605	8256

- All top and bottom cross rails are 1 1/2" wide.
- For built-in appliance support, OCINSTALLKIT is included in 24" deep oven cabinets.
- Oven cabinet cut-out is shaded in gray and is cut out on job site.
- Reduced Depths available in 1/4" increments from 12" to 23 3/4".
- Cabinet installation kit will not be included when depth is modified.
- A cabinet installation kit will be provided.
- Increased Heights modification will increase the height of the upper cabinet section. The bottom section will retain its original height.

	A Frame Opening Height	B Cut-out Width		C Cut-out Height		Door Height (Upper Section) Full Overlay
		Min.	Max.	Min.	Max.	
OCD278424DD	12"	21"	25 1/2"	37 1/4"	52 1/4"	14 1/2"
OCD308424DD	12"	24"	28 1/2"	37 1/4"	52 1/4"	14 1/2"
OCD338424DD	12"	27"	31 1/2"	37 1/4"	52 1/4"	14 1/2"
OCD368424DD	12"	30"	34 1/2"	37 1/4"	52 1/4"	14 1/2"
OCD398424DD	12"	33"	37 1/2"	37 1/4"	52 1/4"	14 1/2"
OCD278724DD	15"	21"	25 1/2"	37 1/4"	52 1/4"	17 1/2"
OCD308724DD	15"	24"	28 1/2"	37 1/4"	52 1/4"	17 1/2"
OCD338724DD	15"	27"	31 1/2"	37 1/4"	52 1/4"	17 1/2"
OCD368724DD	15"	30"	34 1/2"	37 1/4"	52 1/4"	17 1/2"
OCD398724DD	15"	33"	37 1/2"	37 1/4"	52 1/4"	17 1/2"
OCD279024DD	18"	21"	25 1/2"	37 1/4"	52 1/4"	20 1/2"
OCD309024DD	18"	24"	28 1/2"	37 1/4"	52 1/4"	20 1/2"
OCD339024DD	18"	27"	31 1/2"	37 1/4"	52 1/4"	20 1/2"
OCD369024DD	18"	30"	34 1/2"	37 1/4"	52 1/4"	20 1/2"
OCD399024DD	18"	33"	37 1/2"	37 1/4"	52 1/4"	20 1/2"

Maximum cut-out dimension will allow 1/4" reveal for doors and drawer fronts for trim kit face clearance.

Door & Drawer Options

AF	CC	CG	GAMD	HC	IFHG	MC	MD	MFO	PRMD	SHMD	SPLITDR	SPLITDRWS
	✓	✓		✓	✓	✓	✓	✓	✓	✓	✓	✓

End Panel Options

AUTH	CSFPE	EXBK	EXDN	FL/FR	FPE	INTGE	IPE
✓	✓	✓		✓	✓	✓	✓

Custom Modification Options

ADD_SHLF	ADDTK	ADRW	ATTK	BVR	CBO	CCO	CFNTO	CFP	CFRMO	CLIP	CND	CSDGBK	DRWTK ¹	EX	EX_OL	FLUT ²	FTK	ID	
						✓	✓	✓	✓	✓	✓	✓	✓	✓	✓	✓	✓	✓	✓

IH	IW ³	MIP	OBRB	PFINBTMB	RD	RECTK	RH	ROSLUT	RT	SCPDRW	TD	TKP	TVR	VTK	WS	WTCO	WTKCUP	WTR
✓	✓	✓	✓		✓	✓		✓	✓			✓	✓	✓	✓			✓

¹ Not available on units over 36" wide.

² Not available with 6" fluting.

³ Not available on 39" wide.

Oven Cabinets

DOUBLE OVEN TRIMMABLE CABINET with DEEP DRAWER, 93" or 96" HIGH, 24" DEEP

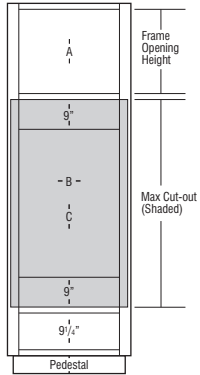
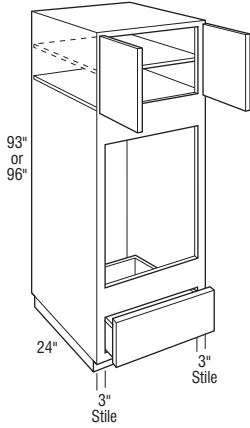

	Cubic Feet	1	2	3	4	5	6	7
OCD279324DDAH	41.3	4130	4331	4485	4730	4970	5435	5900
OCD309324DDAH	45.7	4759	4992	5169	5450	5727	6263	6799
OCD339324DDAH	50.0	5422	5687	5888	6209	6525	7135	7745
OCD369324DDAH	54.4	6062	6358	6584	6943	7296	7978	8660
OCD399324DDAH	58.7	6708	7036	7286	7682	8073	8828	9583
OCD279624DDAH	42.6	4130	4331	4485	4730	4970	5435	5900
OCD309624DDAH	47.1	4759	4992	5169	5450	5727	6263	6799
OCD339624DDAH	51.6	5422	5687	5888	6209	6525	7135	7745
OCD369624DDAH	56.1	6062	6358	6584	6943	7296	7978	8660
OCD399624DDAH	60.6	6708	7036	7286	7682	8073	8828	9583

- AH represents upper section alignment with doors on 24" or 27" high cabinets.
- Upper section has one full depth adjustable shelf.
- Shipped with loose toe-kick unless ATTK or Flush Toe-kick is specified.
- On the 96" high, flush toe-kick option not available in conjunction with Wide Top Rail unless loose Flush Toe-kick is specified.
- All top and bottom cross rails are 1 1/2" wide.
- For built-in appliance support, OCINSTALKIT is included in 24" deep oven cabinets.
- Oven cabinet cut-out is shaded in gray and is cut out on job site.
- For built-in double oven applications, remove drawers as needed.
- Cabinet installation kit will not be included when depth is modified.
- A cabinet installation kit will be provided.
- Increased Heights modification will increase the height of the upper cabinet section. The bottom section will retain its original height.
- Reduced Depths available in 1/4" increments from 12" to 23 3/4".

	A Frame Opening Height	B Cut-out Width		C Cut-out Height		Door Height (Upper Section)
		Min.	Max.	Min.	Max.	Full Overlay
OCD279324DDAH	21"	21"	25 1/2"	37 1/4"	52 1/4"	23 1/2"
OCD309324DDAH	21"	24"	28 1/2"	37 1/4"	52 1/4"	23 1/2"
OCD339324DDAH	21"	27"	31 1/2"	37 1/4"	52 1/4"	23 1/2"
OCD369324DDAH	21"	30"	34 1/2"	37 1/4"	52 1/4"	23 1/2"
OCD399324DDAH	21"	33"	37 1/2"	37 1/4"	52 1/4"	23 1/2"
OCD279624DDAH	24"	21"	25 1/2"	37 1/4"	52 1/4"	26 1/2"
OCD309624DDAH	24"	24"	28 1/2"	37 1/4"	52 1/4"	26 1/2"
OCD339624DDAH	24"	27"	31 1/2"	37 1/4"	52 1/4"	26 1/2"
OCD369624DDAH	24"	30"	34 1/2"	37 1/4"	52 1/4"	26 1/2"
OCD399624DDAH	24"	33"	37 1/2"	37 1/4"	52 1/4"	26 1/2"

Maximum cut-out dimension will allow 1/4" reveal for doors and drawer fronts for trim kit face clearance.

Door & Drawer Options

AF	CC	CG	GAMD	HC	IFHG	MC	MD	MFO	PRMD	SHMD	SPLITDR	SPLITDRWS
✓	✓	✓	✓	✓	✓	✓	✓	✓	✓	✓	✓	✓

End Panel Options

AUTH	CSFPE	EXBK	EXDN	FL/FR	FPE	INTGE	IPE
✓	✓	✓	✓	✓	✓	✓	✓

Custom Modification Options

ADD	SHLF	ADDTK	ADRW	ATTK	BVR	CBO	CCO	CFNTD	CFP	CFRMO	CLIP	CND	CSDGBK	DRWTK ¹	EX	EX_OL	FLUT ²	FTK	ID
✓	✓	✓	✓	✓	✓	✓	✓	✓	✓	✓	✓	✓	✓	✓	✓	✓	✓	✓	✓

IH ³	IW ⁴	MIP	OBRB	PFINBTMB	RD	RECTK	RH	ROSFLUT	RT	SCPDWR	TD	TKP	TVR	VTK	WS	WTCD	WTKCUP	WTR
✓	✓	✓	✓	✓	✓	✓	✓	✓	✓	✓	✓	✓	✓	✓	✓	✓	✓	✓

¹ Not available on units over 36" wide and only available when used in conjunction with attach toe-kick modification.

² Not available with 6" fluting.

³ Not available on 96" high.

⁴ Only available on 39" wide.

IH/RH availability charts starting on page G-40.
IW/RW availability charts starting on page G-46.









How to Use Your Diamond Edge Price List

Your Diamond Edge price guide contains charts with prices for each cabinetry product, arranged according to an alphabetical code. Use the chart below to determine the price code for your preferred cabinetry style.

Then refer to the various sections of this binder to find the types and sizes of cabinets required. Read across each chart to the column that corresponds to your style's price code to determine the price for each unit.

For example, if you want an entertainment base that is 36" wide and 84" high in the Karis Cherry style, you would

- Find the price code for Karis Cherry ("3" in the chart below)
- Refer to the "Office and Furniture Cabinets" section of this binder
- Locate product code EOD24 (EOD = entertainment open door, 24 = width in inches)
- Read across the chart in the same row to column 3 to find the price for this model in Karis Cherry

Door Styles	Alder	Cherry	Maple	MDF	Quartersawn Oak	Rustic Alder	Walnut
Brooks	3	5	3		5	3	6
Brooks Beaded Inset	3+15%	5+15%	3+15%		5+15%	3+15%	6+15%
Brooks Inset	3+15%	5+15%	3+15%		5+15%	3+15%	6+15%
Caldera 	3	5	3		5	3	6
Daxton	2	4	2		4	2	6
Daxton Beaded Inset	2+15%	4+15%	2+15%		4+15%	2+15%	6+15%
Daxton Inset	2+15%	4+15%	2+15%		4+15%	2+15%	6+15%
Gunther	1	3	1		3	1	5
Gunther Beaded Inset	1+15%	3+15%	1+15%		3+15%	1+15%	5+15%
Gunther Inset	1+15%	3+15%	1+15%		3+15%	1+15%	5+15%
Karis	1	3	1		3	1	5
Karis Beaded Inset	1+15%	3+15%	1+15%		3+15%	1+15%	5+15%
Karis Inset	1+15%	3+15%	1+15%		3+15%	1+15%	5+15%
Langley	5	6	5		6	5	7
Langley Beaded Inset	5+15%	6+15%	5+15%		6+15%	5+15%	7+15%
Langley Inset	5+15%	6+15%	5+15%		6+15%	5+15%	7+15%
Montgomery 	1	3	1		3	1	5
Montgomery Beaded Inset 	1+15%	3+15%	1+15%		3+15%	1+15%	5+15%
Montgomery Inset 	1+15%	3+15%	1+15%		3+15%	1+15%	5+15%
Shona	1	3	1		3	1	5
Shona Beaded Inset	1+15%	3+15%	1+15%		3+15%	1+15%	5+15%
Shona Inset	1+15%	3+15%	1+15%		3+15%	1+15%	5+15%
Sumner 	3	5	3		5	3	6
Tackett	2	4	2		4	2	6
Tackett Beaded Inset	2+15%	4+15%	2+15%		4+15%	2+15%	6+15%
Tackett Inset	2+15%	4+15%	2+15%		4+15%	2+15%	6+15%
Trystan 	4	6	4	1	6		7
Trystan Beaded Inset 				1+15%			
Trystan Inset 				1+15%			
Vesta	2	4	2		4	2	6
Vesta Beaded Inset	2+15%	4+15%	2+15%		4+15%	2+15%	6+15%
Vesta Inset	2+15%	4+15%	2+15%		4+15%	2+15%	6+15%
Wells 	4	6	4		6	4	7

Diamond Edge Modification Option Descriptions

Your Diamond Edge price guide contains charts with modification option codes for each applicable cabinetry product. Reference the listing below to identify the modification description.

Door & Drawer Options	
Option	Description
AF	Aluminum Door
CC	Craftsman Door
CG	Cut-for-glass
GAMD	Gallery Mullion Door
IFHG	Inset Finial Hinges
MD	Mullion Door
MFO	Modified Full Overlay
PRMD	Prairie Mullion Door
SGLPN	Single Panel Tall Door
SHMD	Shaker Mullion Door
SPLITDR	Split Doors

End Panel Options	
Option	Description
AUTH	Authentic Flush End
CSFPE	Car Siding Flush Panel End
EXBK	End Extended Back
EXDN	Wall End and Back Extended Down
FFD	Face Frame and Door on End
FL/FR	Finished Ends
FPE	Flush Panel End
INTGE	Integral End
IPE	Inset Panel Ends

Custom Modification Options	
Option	Description
ADDTK	Add Toekick
ADRW	Add Drawer Below Wall Unit
BVR	Bottom Valance Rail
CBO	Cabinet Box Only
CCO	Cabinet Case Only
CFNTO	Cabinet Front Only
CFP	Cabinet False Panel
CFRMO	Cabinet Frame Only
CLIP	Clipped Corner
CND	Cabinet No Door
CSDGBK	Car Siding Back
DRWTK	Toekick Drawer
EX	Extended Stile
EX_OL	Extended Stile with Overlay
FD	Full Depth Shelf
FLUT	Fluting
FTK	Flush Toekick
ID	Increased Depth
IH	Increased Height
INVFRM	Inverted Frame
IW	Increased Width
MIP	Matching Interior
OBRB	Open Bottom Rail Base
PFINBTMB	Finished Bottom
RD	Reduced Depth
RECTK	Recessed Toekick
RECTKFRT	Recessed Toekick Front
RH	Reduced Height
ROSLUT	Rose Fluting
RT	Roll Trays
RW	Reduced Width
STORB	Storage Open Rail Base
TD	Tray Divider
TKP	Toekick Pedestal
TVR	Top Valance Rail
VTK	Void Toekick
WS	Wide Stiles
WTR	Wide Top Rail

ENTRY ENSEMBLE TALL, 66", 72", or 78" HIGH, 21" DEEP

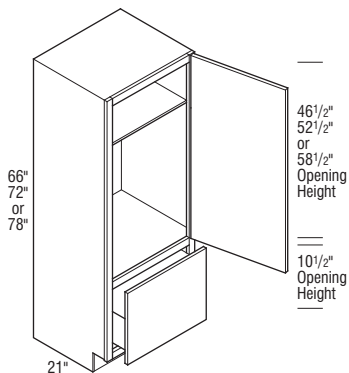

	Cubic Feet	1	2	3	4	5	6	7
EET1866 L or R	17.9	3682	3862	3994	4217	4464	4876	5288
EET2166 L or R	20.7	4034	4228	4378	4616	4890	5340	5790
EET2466 L or R	23.4	4408	4624	4784	5045	5344	5838	6332
EET1872 L or R	19.5	3798	3982	4120	4344	4601	5029	5457
EET2172 L or R	22.5	4157	4356	4507	4756	5039	5501	5963
EET2472 L or R	25.5	4543	4760	4928	5196	5505	6009	6513
EET1878 L or R	21.1	3916	4105	4248	4479	4744	5182	5620
EET2178 L or R	24.3	4281	4489	4644	4896	5188	5665	6142
EET2478 L or R	27.6	4678	4902	5076	5350	5670	6194	6718

- Includes one fixed shelf.
- Matching Interior and Finished Ends standard.
- Large opening on tall doors will include two center panels divided by a horizontal rail.
- Increased Depths available in 1/4" increments from 21 1/4" to 24".
- Reduced Depths available in 1/4" increments from 12" to 20 3/4".

Door & Drawer Options

AF	CC	CG	GAMD	IFHG	MD	MFO	PRMD	SGLPN ¹	SHMD	SPLITDR
✓	✓	✓	✓	✓	✓	✓	✓	✓		

End Panel Options

AUTH	CSFPE	EXBK	EXDN	FFD	FL/FR	FPE	INTGE	IPE
✓	✓	✓	✓	✓	✓	✓	✓	✓

Custom Modification Options

ADDTK	ADRW	BVR	CBO	CCO	CFNTD	CFP	CFRMO	CLIP	CND	CSDGBK	DRWTK	EX	EX_OL	FD	FLUT ²	FTK	ID	IH	INVFRM	
✓	✓	✓	✓	✓	✓	✓	✓	✓	✓	✓	✓	✓	✓	✓	✓	✓	✓	✓	✓	✓

IW	MIP	OBRB	PFINBTMB	RD	RECTK	RECTKFRT	RH	ROSFLUT	RT	RW ³	STORB	TD	TKP	TVR	VTK	WS	WTR
✓	✓	✓	✓	✓	✓	✓	✓	✓	✓	✓	✓	✓	✓	✓	✓	✓	✓

¹ Only available on 78" high.

² Not available with 6" fluting.

³ Only available on 18" wide.

ENTRY ENSEMBLE DRAWER BASE, 18" HIGH, 21" DEEP

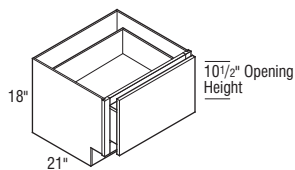

EEDB18	5.2	1707	1791	1854	1952	2069	2261	2453
EEDB21	6.0	1800	1885	1951	2058	2180	2379	2578
EEDB24	6.8	1854	1945	2010	2122	2245	2454	2663
EEDB36	9.9	2129	2235	2313	2438	2581	2818	3055

- Matching Interior and Finished Ends standard.
- Increased Depths available in 1/4" increments from 21 1/4" to 24".
- Reduced Depths available in 1/4" increments from 12" to 20 3/4".

Door & Drawer Options

AF	CC	CG	GAMD	IFHG	MD	MFO	PRMD	SGLPN	SHMD	SPLITDR

End Panel Options

AUTH	CSFPE	EXBK	EXDN	FFD	FL/FR	FPE	INTGE	IPE
✓	✓	✓	✓	✓	✓	✓	✓	✓

Custom Modification Options

ADDTK	ADRW	BVR	CBO	CCO	CFNTD	CFP	CFRMO	CLIP	CND	CSDGBK	DRWTK	EX	EX_OL	FD	FLUT ¹	FTK	ID	IH	INVFRM	
✓	✓	✓	✓	✓	✓	✓	✓	✓	✓	✓	✓	✓	✓	✓	✓	✓	✓	✓	✓	✓

IW	MIP	OBRB	PFINBTMB	RD	RECTK	RECTKFRT	RH	ROSFLUT	RT	RW ²	STORB	TD	TKP	TVR	VTK	WS	WTR
✓	✓	✓	✓	✓	✓	✓	✓	✓	✓	✓	✓	✓	✓	✓	✓	✓	✓

¹ 6" fluting not available with 18" wide. Fluting both 6" also not available on 21" wide.

² Only available on 18" wide.

Entry Ensembles

ENTRY ENSEMBLE OPEN BASE, 18" HIGH, 21" DEEP

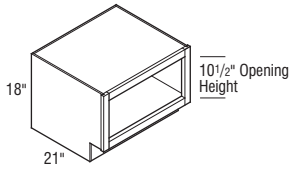

	Cubic Feet	1	2	3	4	5	6	7
EEOB18	5.2	1963	2059	2131	2246	2380	2602	2824
EEOB21	6.0	2067	2165	2241	2366	2507	2735	2963
EEOB24	6.8	2129	2235	2313	2438	2581	2818	3055
EEOB36	9.9	2452	2569	2658	2801	2970	3243	3516

- Matching Interior and Finished Ends standard.
- Increased Depths available in 1/4" increments from 21 1/4" to 30".
- Reduced Depths available in 1/4" increments from 6" to 20 3/4".

Door & Drawer Options

AF	CC	CG	GAMD	IFHG	MD	MFO	PRMD	SGLPN	SHMD	SPLITDR
----	----	----	------	------	----	-----	------	-------	------	---------

End Panel Options

AUTH	CSFPE	EXBK	EXDN	FFD	FL/FR	FPE	INTGE	IPE
✓	✓	✓				✓	✓	✓

Custom Modification Options

ADDTK	ADRW	BVR	CBO	CCO	CFNTD	CFP	CFRMO	CLIP	CND	CSDGBK	DRWTK	EX	EX_OL	FD	FLUT ¹	FTK	ID	IH	INVRM
			✓	✓	✓		✓			✓		✓	✓		✓	✓			

IW	MIP	OBRB	PFINBTMB	RD	RECTK	RECTKFRT	RH	ROSFLOT	RT	RW ²	STORB	TD	TKP	TVR	VTK	WS	WTR
		✓		✓	✓			✓		✓	✓	✓	✓	✓	✓	✓	✓

¹ Fluting both 6" not available on 18" or 21" wide.

² Only available on 18" wide.

IH/RH availability charts starting on page G•40.
IW/RW availability charts starting on page G•46.

ENTRY ENSEMBLE STACKED WALL OPEN, 46 1/2", 52" 1/2", or 58 1/2" HIGH

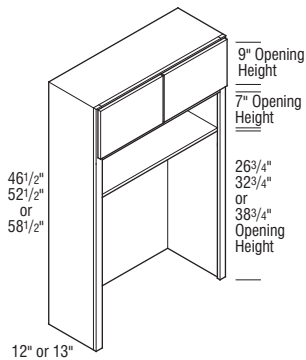
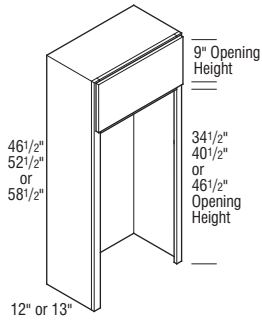

	Cubic Feet	1	2	3	4	5	6	7
EESTWO1846.5 L or R	7.9	1599	1674	1733	1826	1936	2117	2298
EESTWO2146.5 L or R	9.1	1746	1827	1892	1997	2117	2310	2503
EESTWO2446.5 L or R	10.3	2017	2118	2190	2310	2448	2672	2896

EESTWO1852.5 L or R	8.8	1645	1725	1785	1882	1994	2180	2366
EESTWO2152.5 L or R	10.2	1851	1940	2005	2117	2240	2451	2662
EESTWO2452.5 L or R	11.6	2078	2180	2255	2378	2519	2752	2985

EESTWO1858.5 L or R	9.8	1698	1778	1838	1942	2056	2243	2430
EESTWO2158.5 L or R	11.3	1907	1998	2068	2182	2310	2523	2736
EESTWO2458.5 L or R	12.8	2138	2243	2323	2452	2594	2834	3074

EESTWO2446.5	10.3	2272	2379	2464	2598	2751	3003	3255
EESTWO3646.5	15.1	2479	2602	2693	2837	3004	3285	3566

• Includes one fixed shelf.

EESTWO2452.5	11.6	2336	2452	2537	2673	2833	3093	3353
EESTWO3652.5	17.0	2555	2677	2770	2922	3095	3382	3669

• Includes one fixed shelf.

EESTWO2458.5	12.8	2409	2524	2614	2753	2917	3186	3455
EESTWO3658.5	18.9	2629	2757	2855	3008	3187	3481	3775

• Includes one fixed shelf.

Notes below apply to all products in section above:

- Matching Interior and Finished Ends standard.
- Inset and Beaded Inset styles are a standard 13" deep.
- Full Overlay Styles:
 - Increased Depths available in 1/4" increments from 12 1/4" to 24"
 - Reduced Depths available in 1/4" increments from 6" to 11 3/4"

Door & Drawer Options

AF	CC	CG	GAMD	IFHG	MD	MFO	PRMD	SGLPN	SHMD	SPLITDR ¹
✓	✓	✓	✓	✓	✓	✓	✓	✓	✓	✓

End Panel Options

AUTH	CSFPE	EXBK	EXDN	FFD	FL/FR	FPE	INTGE	IPE
✓	✓	✓	✓	✓	✓	✓	✓	✓

Custom Modification Options

ADDTK	ADRW	BVR	CBO	CCO	CFNTD	CFP	CFRMO	CLIP	CND	CSDGBK	DRWTK	EX	EX_OL	FD	FLUT ²	FTK	ID	IH	INVERM
✓	✓	✓	✓	✓	✓	✓	✓	✓	✓	✓	✓	✓	✓	✓	✓	✓	✓	✓	✓

IW	MIP	OBRB	PFINBTMB	RD	RECTK ³	RECTKFRT	RH	ROSLUT	RT	RW ⁴	STORB	TD	TKP	TVR	VTK	WS ⁵	WTR
✓	✓	✓	✓	✓	✓	✓	✓	✓	✓	✓	✓	✓	✓	✓	✓	✓	✓

¹ Not available on 18" or 21" wide.

² Not available with 6" fluting.

³ Only available with RECTKL.R.BK.

⁴ Only available on 18" and 36" wide.

⁵ Not available on 24" (2 doors) wide.

Entry Ensembles

ENTRY ENSEMBLE STACKED WALL, 46 1/2", 52 1/2", or 58 1/2" HIGH

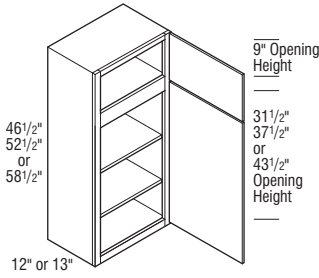

	Cubic Feet	1	2	3	4	5	6	7	
EESTW1846.5 L or R	7.9	2876	3015	3122	3291	3488	3809	4130	
EESTW2146.5 L or R	9.1	3146	3299	3416	3599	3816	4165	4514	
EESTW2446.5 L or R	10.3	3438	3601	3729	3930	4165	4549	4933	
• Includes two adjustable shelves.									
EESTW1852.5 L or R	8.8	2966	3111	3218	3390	3592	3924	4256	
EESTW2152.5 L or R	10.2	3239	3395	3518	3708	3928	4291	4654	
EESTW2452.5 L or R	11.6	3540	3711	3841	4052	4293	4688	5083	
• Includes three adjustable shelves.									
EESTW1858.5 L or R	9.8	3056	3203	3318	3495	3703	4044	4385	
EESTW2158.5 L or R	11.3	3335	3497	3623	3820	4045	4419	4793	
EESTW2458.5 L or R	12.8	3646	3825	3960	4170	4421	4828	5235	
• Includes three adjustable shelves.									

Notes below apply to all products in section above:

- Matching Interior and Finished Ends standard.
- Inset and Beaded Inset styles are a standard 13" deep.
- Full Overlay Styles:
 - Increased Depths available in 1/4" increments from 12 1/4" to 30".
 - Reduced Depths available in 1/4" increments from 6" to 11 3/4".
- Inset and Beaded Inset Styles:
 - Increased Depths available in 1/4" increments from 13 1/4" to 24".
 - Reduced Depths available in 1/4" increments from 6" to 12 3/4".

Door & Drawer Options

AF	CC	CG	GAMD	IFHG	MD	MFO	PRMD	SGLPN	SHMD	SPLITDR
✓	✓	✓	✓	✓	✓	✓	✓	✓	✓	✓

End Panel Options

AUTH	CSFPE	EXBK	EXDN	FFD	FL/FR	FPE	INTGE	IPE
✓	✓	✓	✓	✓	✓	✓	✓	✓

Custom Modification Options

ADDTK	ADRW	BVR	CBO	CCO	CFNT	CFP	CFRMO	CLIP	CND	CSDGBK	DRWTK	EX	EX_OL	FD	FLUT ¹	FTK	ID	IH	INVFRM
✓	✓	✓	✓	✓	✓	✓	✓	✓	✓	✓	✓	✓	✓	✓	✓	✓	✓	✓	✓
IW	MIP	OBRB	PFINBTMB	RD	RECTK	RECTKFRT	RH	ROSLUT	RT	RW ²	STORB	TD	TKP	TVR	VTK	WS	WTR		
		✓	✓	✓	✓	✓	✓	✓	✓	✓			✓	✓	✓	✓	✓		

¹ Not available with 6" fluting.

² Only available on 18" wide.

IH/RH availability charts starting on page G•40.
IW/RW availability charts starting on page G•46.

ENTRY ENSEMBLE STACKED WALL MESSAGE, 46 1/2", 52 1/2", or 58 1/2" HIGH

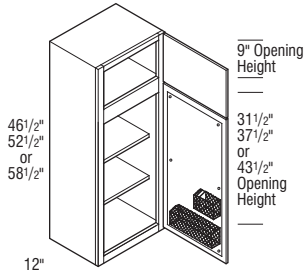

Cubic Feet	1	2	3	4	5	6	7	
EESTWM1846.5 L or R	7.9	3134	3287	3399	3587	3799	4149	4499
EESTWM2146.5 L or R	9.1	3426	3591	3719	3921	4154	4537	4920
EESTWM1852.5 L or R	8.8	3232	3385	3502	3695	3916	4277	4638
EESTWM2152.5 L or R	10.2	3528	3699	3830	4037	4279	4672	5065
EESTWM1858.5 L or R	9.8	3325	3488	3608	3804	4029	4403	4777
EESTWM2158.5 L or R	11.3	3635	3811	3945	4159	4405	4812	5219

• Includes two adjustable shelves.

• Includes three adjustable shelves.

• Includes three adjustable shelves.

Notes below apply to all products in section above:

- Matching Interior and Finished Ends standard.
- Includes whiteboard, pencil holder, and mail holder.
- Full Overlay Styles:
 - Increased Depths available in 1/4" increments from 12 1/4" to 30".
 - Reduced Depths available in 1/4" increments from 9" to 11 3/4".
- Not available on Inset and Beaded Inset styles.

Door & Drawer Options

AF	CC	CG	GAMD	IFHG	MD	MFO	PRMD	SGLPN	SHMD	SPLITDR
✓	✓	✓					✓			✓

End Panel Options











AUTH	CSFPE	EXBK	EXDN	FFD	FL/FR	FPE	INTGE	IPE
✓	✓	✓	✓				✓	✓

Custom Modification Options

ADDTK	ADRW	BVR	CBO	CCO	CFNT0	CFP	CFRMO	CLIP	CND	CSDGBK	DRWTK	EX	EX_OL	FD	FLUT ¹	FTK	ID	IH	INVERM
✓	✓	✓							✓	✓		✓	✓	✓	✓	✓	✓	✓	✓
IW	MIP	OBRB	PFINBTMB	RD	RECTK	RECTKFRT	RH	ROSFLUT	RT	RW	STORB	TD	TKP	TVR	VTK	WS	WTR		
	✓	✓	✓	✓	✓	✓		✓					✓	✓	✓	✓	✓		

¹ Not available with 6" fluting.

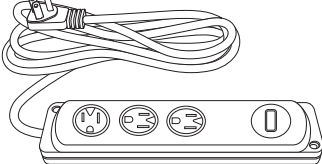
Entry Ensemble Accessories

		Cubic Feet	1	2	3	4	5	6	7
SINGLE HOOK NICKEL		EEHSN	0.2	65	65	65	65	65	65
		Modifications Are Not Available							
DOUBLE HOOK NICKEL		EEHDN	0.2	112	112	112	112	112	112
		Modifications Are Not Available							
SINGLE HOOK BLACK		EEHSB	0.2	60	60	60	60	60	60
		Modifications Are Not Available							
DOUBLE HOOK BLACK		EEHDB	0.2	101	101	101	101	101	101
		Modifications Are Not Available							
POWER STRIP		EEPWR	0.2	241	241	241	241	241	241
		<ul style="list-style-type: none"> • Power strip is black. Modifications Are Not Available							
GROMMET		EEGRM	0.2	10	10	10	10	10	10
		<ul style="list-style-type: none"> • Grommet is black. Modifications Are Not Available							

IH/RH availability charts starting on page G•40.
IW/RW availability charts starting on page G•46.

ENTRY ENSEMBLE 1, 66" WIDE x 78" HIGH x 21" DEEP

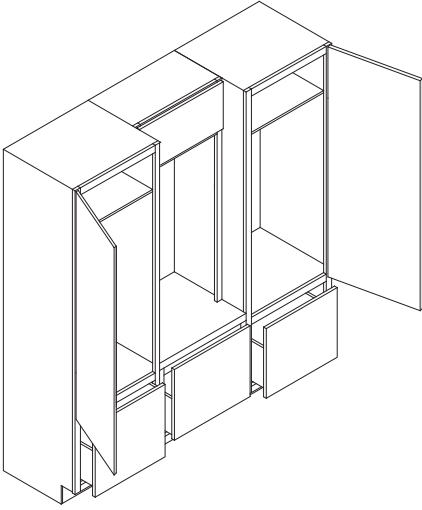

Parts Required	Quantity
(1) EET_----	1
(2) EESTWO_----	1
(3) EEDB_--	1
(4) EET_----	1
(5) WOODTOP	1

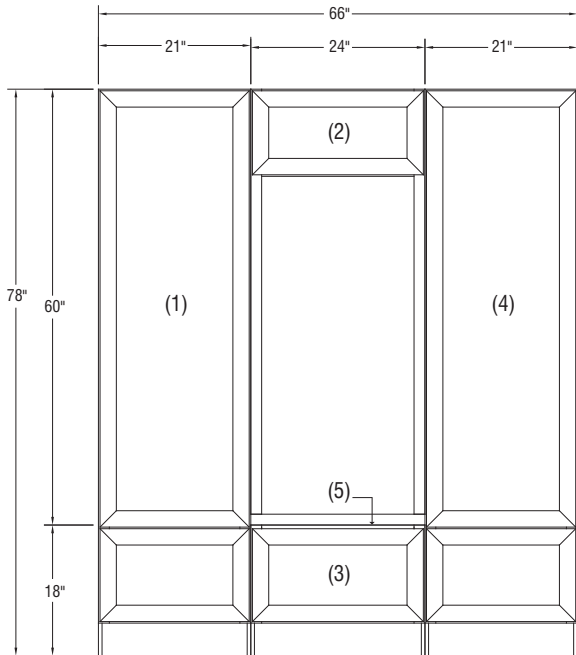

Entry Ensembles

ENTRY ENSEMBLE 2, 72" WIDE x 72" HIGH x 21" DEEP

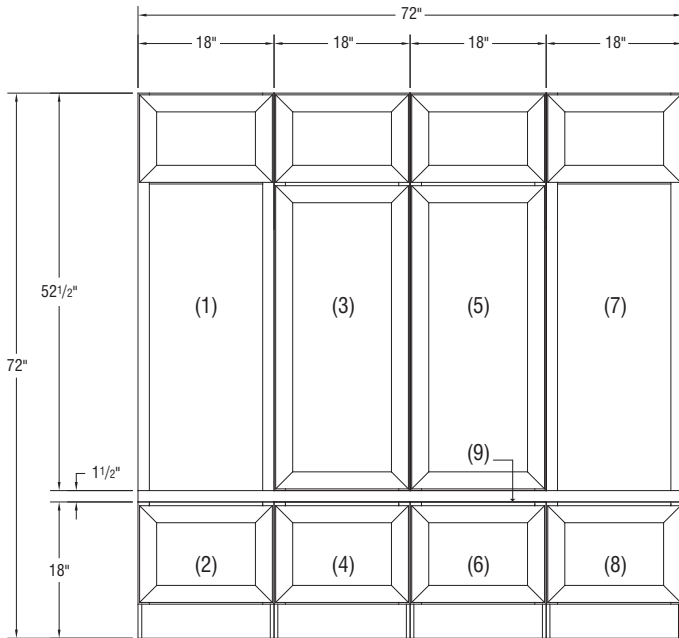
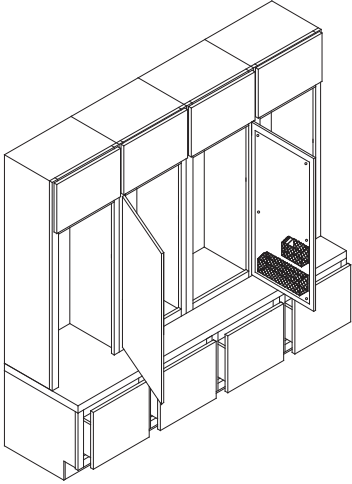

Parts Required	Quantity
(1) EESTWO_____	1
(2) EEDB__	1
(3) EESTWM_____	1
(4) EEDB__	1
(5) EESTW_____	1
(6) EEDB__	1
(7) EESTWO_____	1
(8) EEDB__	1
(9) WOODTOP	1

ENTRY ENSEMBLE 3, 72" WIDE x 78" HIGH x 21" DEEP

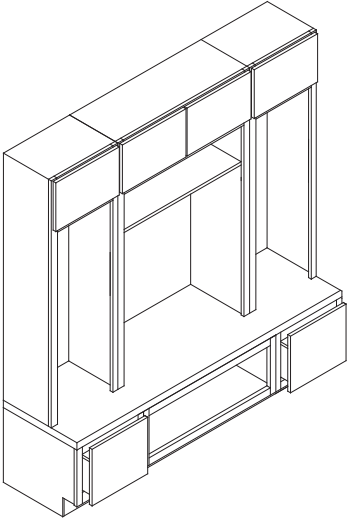

Parts Required	Quantity
(1) EESTWO_	1
(2) EEDB_	1
(3) EESTWO_	1
(4) EEOB_	1
(5) EESTWO_	1
(6) EEDB_	1
(7) WOODTOP	1

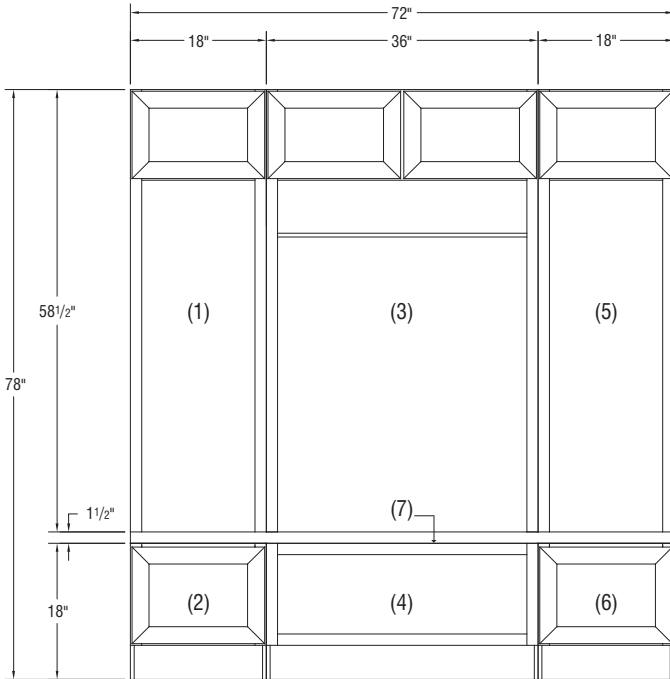

Entertainment Centers

ENTERTAINMENT OPEN DRAWER, 18" HIGH, 21" DEEP

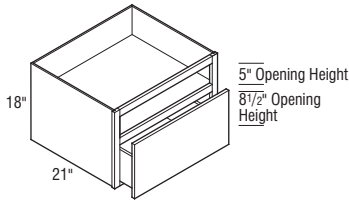

	Cubic Feet	1	2	3	4	5	6	7
EOD24	6.8	1533	1605	1661	1751	1856	2027	2198

- Finished Ends and Matching Interior standard.
- Void toe-kick standard.
- Increased Depths available in 1/4" increments from 21 1/4" to 24".
- Reduced Depths available in 1/4" increments from 12" to 20 3/4".

Door & Drawer Options

AF	CC	CG	GAMD	IFHG	MD	MFO	PRMD	SGLPN	SHMD	SPLITDR
	✓	✓	✓	✓	✓	✓	✓	✓	✓	✓

End Panel Options

AUTH	CSFPE	EXBK	EXDN	FFD	FL/FR	FPE	INTGE	IPE
✓	✓	✓	✓	✓	✓	✓	✓	✓

Custom Modification Options

ADDTK	ADRW	BVR	CBO	CCO	CFNTD	CFP	CFRMO	CLIP	CND	CSDGBK	DRWTK	EX	EX_OL	FD	FLUT	FTK	ID	IH	INVFRM	
✓			✓	✓	✓	✓	✓	✓	✓	✓	✓	✓	✓	✓	✓	✓	✓	✓	✓	✓

IW	MIP	OBRB	PFINBTMB	RD	RECTK	RECTKFRT	RH	ROSFLUT	RT	RW	STORB	TD	TKP	TVR	VTK	WS	WTR
✓	✓	✓	✓	✓	✓	✓	✓	✓	✓	✓	✓	✓	✓	✓	✓	✓	✓

ENTERTAINMENT BASE, NO TOEKICK, 18" HIGH, 21" DEEP

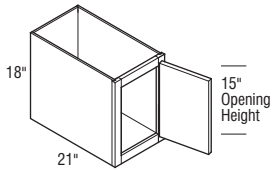

	Cubic Feet	1	2	3	4	5	6	7
EB12NTK L or R	3.6	1297	1358	1406	1481	1570	1715	1860

- Finished Ends and Matching Interior standard.
- Increased Depths available in 1/4" increments from 21 1/4" to 30".
- Reduced Depths available in 1/4" increments from 6" to 20 3/4".

Door & Drawer Options

AF	CC	CG	GAMD	IFHG	MD	MFO	PRMD	SGLPN	SHMD	SPLITDR
	✓	✓	✓	✓	✓	✓	✓	✓	✓	✓

End Panel Options

AUTH	CSFPE	EXBK	EXDN	FFD	FL/FR	FPE	INTGE	IPE
✓	✓	✓	✓	✓	✓	✓	✓	✓

Custom Modification Options

ADDTK	ADRW	BVR	CBO	CCO	CFNTD	CFP	CFRMO	CLIP	CND	CSDGBK	DRWTK	EX	EX_OL	FD	FLUT ¹	FTK ²	ID	IH	INVFRM	
✓			✓	✓	✓	✓	✓	✓	✓	✓	✓	✓	✓	✓	✓	✓	✓	✓	✓	✓

IW	MIP	OBRB	PFINBTMB	RD	RECTK	RECTKFRT	RH	ROSFLUT	RT	RW	STORB	TD	TKP	TVR	VTK	WS ³	WTR
✓	✓	✓	✓	✓	✓	✓	✓	✓	✓	✓	✓	✓	✓	✓	✓	✓	✓

¹ Not available with 6" fluting.

² Not available with FTKAV and style B-L.

³ Not available with wide stile both 3".

ENTERTAINMENT BASE, 27" HIGH, 18" DEEP

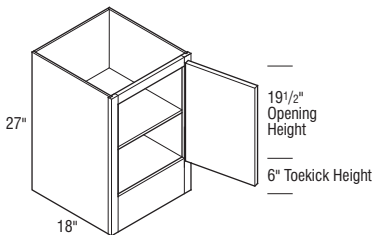

	Cubic Feet	1	2	3	4	5	6	7
EB18 L or R	6.6	1421	1491	1543	1626	1723	1882	2041

- Finished Ends, Matching Interior, Flush Toe-kick, and Full Depth Shelf standard.
- Increased Depths available in 1/4" increments from 18 1/4" to 30".
- Reduced Depths available in 1/4" increments from 6" to 17 3/4".

Door & Drawer Options

AF	CC	CG	GAMD	IFHG	MD	MFO	PRMD	SGLPN	SHMD	SPLITDR
	✓	✓	✓	✓	✓	✓	✓	✓	✓	✓

End Panel Options

AUTH	CSFPE	EXBK	EXDN	FFD	FL/FR	FPE	INTGE	IPE
✓	✓	✓	✓	✓	✓	✓	✓	✓

Custom Modification Options

ADDTK	ADRW	BVR	CBO	CCO	CFNTD	CFP	CFRMO	CLIP	CND	CSDGBK	DRWTK	EX	EX_OL	FD	FLUT ¹	FTK ²	ID	IH	INVFRM	
✓			✓	✓	✓	✓	✓	✓	✓	✓	✓	✓	✓	✓	✓	✓	✓	✓	✓	✓

IW	MIP	OBRB	PFINBTMB	RD	RECTK	RECTKFRT	RH	ROSFLUT	RT	RW	STORB	TD	TKP	TVR	VTK	WS	WTR
✓	✓	✓	✓	✓	✓	✓	✓	✓	✓	✓	✓	✓	✓	✓	✓	✓	✓

¹ Not available with fluting both 6".

² Only available on FTKAV and style B-L.

IH/RH availability charts starting on page G-40.
IW/RW availability charts starting on page G-46.

ENTERTAINMENT WALL, 36" HIGH, 9" DEEP

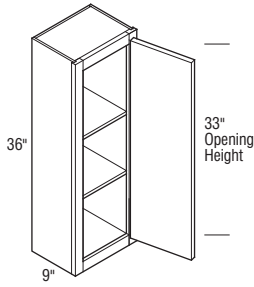

Cubic Feet	1	2	3	4	5	6	7	
EW1236 L or R	3.4	1417	1468	1503	1567	1631	1748	1865

- Finished Ends and Matching Interior standard.
- Increased Depths available in 1/4" increments from 9 1/4" to 30".
- Reduced Depths available in 1/4" increments from 6" to 8 3/4".

Door & Drawer Options

AF	CC	CG	GAMD	IFHG	MD	MFO	PRMD	SGLPN	SHMD	SPLITDR
	✓	✓	✓	✓	✓	✓			✓	

End Panel Options

AUTH	CSFPE	EXBK	EXDN	FFD	FL/FR	FPE	INTGE	IPE
✓	✓	✓	✓	✓	✓	✓	✓	✓

Custom Modification Options

ADDTK	ADRW	BVR	CBO	CCO	CFNTD	CFP	CFRMO	CLIP	CND	CSDGBK	DRWTK	EX	EX_OL	FD	FLUT ¹	FTK ²	ID	IH	INVERM	
✓	✓	✓	✓	✓	✓	✓	✓	✓	✓	✓	✓	✓	✓	✓	✓	✓	✓	✓	✓	✓

IW	MIP	OBRB	PFINBTMB	RD	RECTK	RECTKFRT	RH	ROSFLUT	RT	RW	STORB	TD	TKP	TVR	VTK	WS ³	WTR
✓	✓	✓	✓	✓	✓	✓	✓	✓	✓	✓	✓	✓	✓	✓	✓	✓	✓

¹ Not available with 6" fluting.

² Not available with FTKAV and style B-L.

³ Not available with wide stile both 3".

ENTERTAINMENT STACKED WALL, 58 1/2" HIGH, 18" DEEP

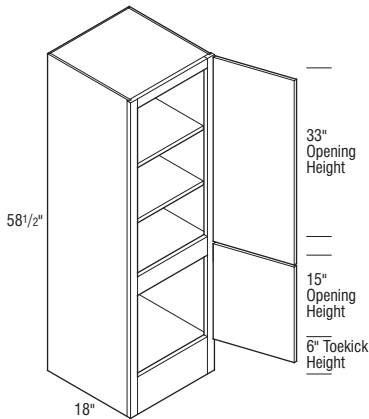

ESTW1858.5 L or R	13.9	2498	2613	2703	2826	2927	3098	3269
--------------------------	------	------	------	------	------	------	------	------

- Finished Ends, Matching Interior, and Flush Toe Kick standard.
- Increased Depths available in 1/4" increments from 18 1/4" to 30".
- Reduced Depths available in 1/4" increments from 6" to 17 3/4".

Door & Drawer Options

AF	CC	CG	GAMD	IFHG	MD	MFO	PRMD	SGLPN	SHMD	SPLITDR
	✓	✓	✓	✓	✓	✓			✓	

End Panel Options

AUTH	CSFPE	EXBK	EXDN	FFD	FL/FR	FPE	INTGE	IPE
✓	✓	✓	✓	✓	✓	✓	✓	✓

Custom Modification Options

ADDTK	ADRW	BVR	CBO	CCO	CFNTD	CFP	CFRMO	CLIP	CND	CSDGBK	DRWTK	EX	EX_OL	FD	FLUT ¹	FTK ²	ID	IH	INVERM	
✓	✓	✓	✓	✓	✓	✓	✓	✓	✓	✓	✓	✓	✓	✓	✓	✓	✓	✓	✓	✓

IW	MIP	OBRB	PFINBTMB	RD	RECTK	RECTKFRT	RH	ROSFLUT	RT	RW	STORB	TD	TKP	TVR	VTK	WS	WTR
✓	✓	✓	✓	✓	✓	✓	✓	✓	✓	✓	✓	✓	✓	✓	✓	✓	✓

¹ Not available with 6" fluting.

² Only available with FTKAV and style B-L.

FOUR DRAWER ENTERTAINMENT BASE, 27" HIGH, 18" DEEP

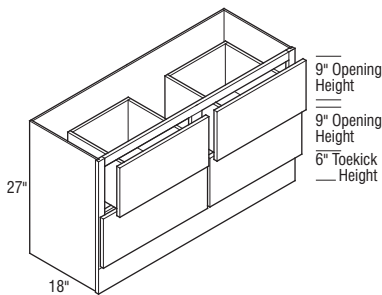

4EDB48	16.7	3934	4126	4270	4501	4772	5210	5648
---------------	------	------	------	------	------	------	------	------

- Finished Ends, Matching Interior, and Flush Toe Kick standard.
- Increased Depths available in 1/4" increments from 18 1/4" to 24".
- Reduced Depths available in 1/4" increments from 12" to 17 3/4".

Door & Drawer Options

AF	CC	CG	GAMD	IFHG	MD	MFO	PRMD	SGLPN	SHMD	SPLITDR
	✓	✓	✓	✓	✓	✓			✓	

End Panel Options

AUTH	CSFPE	EXBK	EXDN	FFD	FL/FR	FPE	INTGE	IPE
✓	✓	✓	✓	✓	✓	✓	✓	✓

Custom Modification Options

ADDTK	ADRW	BVR	CBO	CCO	CFNTD	CFP	CFRMO	CLIP	CND	CSDGBK	DRWTK	EX	EX_OL	FD	FLUT ¹	FTK ²	ID	IH	INVERM	
✓	✓	✓	✓	✓	✓	✓	✓	✓	✓	✓	✓	✓	✓	✓	✓	✓	✓	✓	✓	✓

IW	MIP	OBRB	PFINBTMB	RD	RECTK	RECTKFRT	RH	ROSFLUT	RT	RW	STORB	TD	TKP	TVR	VTK	WS	WTR
✓	✓	✓	✓	✓	✓	✓	✓	✓	✓	✓	✓	✓	✓	✓	✓	✓	✓

¹ Not available with 6" fluting.

² Only available with FTKAV and style B-L.

Entertainment Centers

	Cubic Feet	1	2	3	4	5	6	7	
FOUR DRAWER ENTERTAINMENT BASE, NO TOEKICK, 18" HIGH, 15" DEEP	4EDB48NTK	9.8	3315	3472	3593	3789	4017	4386	4755

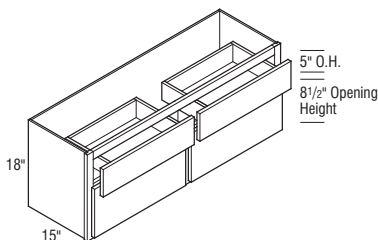

Door & Drawer Options

AF	CC	CG	GAMD	IFHG	MD	MFO	PRMD	SGLPN	SHMD	SPLITDR
<input checked="" type="checkbox"/>	<input checked="" type="checkbox"/>	<input checked="" type="checkbox"/>	<input checked="" type="checkbox"/>	<input checked="" type="checkbox"/>	<input checked="" type="checkbox"/>	<input checked="" type="checkbox"/>	<input checked="" type="checkbox"/>	<input checked="" type="checkbox"/>	<input checked="" type="checkbox"/>	<input checked="" type="checkbox"/>

End Panel Options

AUTH	CSFPE	EXBK	EXDN	FFD	FL/FR	FPE	INTGE	IPE
<input checked="" type="checkbox"/>	<input checked="" type="checkbox"/>	<input checked="" type="checkbox"/>	<input checked="" type="checkbox"/>	<input checked="" type="checkbox"/>	<input checked="" type="checkbox"/>	<input checked="" type="checkbox"/>	<input checked="" type="checkbox"/>	<input checked="" type="checkbox"/>

Custom Modification Options

ADDTK	ADRW	BVR	CBO	CCO	CFNT0	CFP	CFRMO	CLIP	CND	CSDGBK	DRWTK	EX	EX_OL	FD	FLUT ¹	FTK	ID	IH	INVRM
<input checked="" type="checkbox"/>	<input checked="" type="checkbox"/>	<input checked="" type="checkbox"/>	<input checked="" type="checkbox"/>	<input checked="" type="checkbox"/>	<input checked="" type="checkbox"/>	<input checked="" type="checkbox"/>	<input checked="" type="checkbox"/>	<input checked="" type="checkbox"/>	<input checked="" type="checkbox"/>	<input checked="" type="checkbox"/>	<input checked="" type="checkbox"/>	<input checked="" type="checkbox"/>	<input checked="" type="checkbox"/>	<input checked="" type="checkbox"/>	<input checked="" type="checkbox"/>	<input checked="" type="checkbox"/>	<input checked="" type="checkbox"/>	<input checked="" type="checkbox"/>	<input checked="" type="checkbox"/>

IW	MIP	OBRB	PFINBTMB	RD	RECTK	RECTKERT	RH	ROSFLUT	RT	RW	STORB	TD	TKP	TVR	VTK	WS	WTR
<input checked="" type="checkbox"/>	<input checked="" type="checkbox"/>	<input checked="" type="checkbox"/>	<input checked="" type="checkbox"/>	<input checked="" type="checkbox"/>	<input checked="" type="checkbox"/>	<input checked="" type="checkbox"/>	<input checked="" type="checkbox"/>	<input checked="" type="checkbox"/>	<input checked="" type="checkbox"/>	<input checked="" type="checkbox"/>	<input checked="" type="checkbox"/>	<input checked="" type="checkbox"/>	<input checked="" type="checkbox"/>	<input checked="" type="checkbox"/>	<input checked="" type="checkbox"/>	<input checked="" type="checkbox"/>	<input checked="" type="checkbox"/>

¹ Not available with 6" fluting.

SIX DRAWER ENTERTAINMENT BASE, NO TOEKICK, 22 1/2" HIGH, 18" DEEP	6EDB54	15.8	3975	4167	4313	4547	4817	5261	5705
--	---------------	------	------	------	------	------	------	------	------

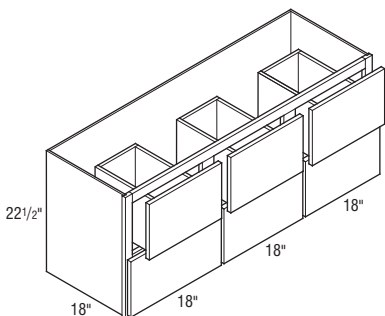

Door & Drawer Options

AF	CC	CG	GAMD	IFHG	MD	MFO	PRMD	SGLPN	SHMD	SPLITDR
<input checked="" type="checkbox"/>	<input checked="" type="checkbox"/>	<input checked="" type="checkbox"/>	<input checked="" type="checkbox"/>	<input checked="" type="checkbox"/>	<input checked="" type="checkbox"/>	<input checked="" type="checkbox"/>	<input checked="" type="checkbox"/>	<input checked="" type="checkbox"/>	<input checked="" type="checkbox"/>	<input checked="" type="checkbox"/>

End Panel Options

AUTH	CSFPE	EXBK	EXDN	FFD	FL/FR	FPE	INTGE	IPE
<input checked="" type="checkbox"/>	<input checked="" type="checkbox"/>	<input checked="" type="checkbox"/>	<input checked="" type="checkbox"/>	<input checked="" type="checkbox"/>	<input checked="" type="checkbox"/>	<input checked="" type="checkbox"/>	<input checked="" type="checkbox"/>	<input checked="" type="checkbox"/>

Custom Modification Options

ADDTK	ADRW	BVR	CBO	CCO	CFNT0	CFP	CFRMO	CLIP	CND	CSDGBK	DRWTK	EX	EX_OL	FD	FLUT ¹	FTK	ID	IH	INVRM
<input checked="" type="checkbox"/>	<input checked="" type="checkbox"/>	<input checked="" type="checkbox"/>	<input checked="" type="checkbox"/>	<input checked="" type="checkbox"/>	<input checked="" type="checkbox"/>	<input checked="" type="checkbox"/>	<input checked="" type="checkbox"/>	<input checked="" type="checkbox"/>	<input checked="" type="checkbox"/>	<input checked="" type="checkbox"/>	<input checked="" type="checkbox"/>	<input checked="" type="checkbox"/>	<input checked="" type="checkbox"/>	<input checked="" type="checkbox"/>	<input checked="" type="checkbox"/>	<input checked="" type="checkbox"/>	<input checked="" type="checkbox"/>	<input checked="" type="checkbox"/>	<input checked="" type="checkbox"/>

IW	MIP	OBRB	PFINBTMB	RD	RECTK	RECTKERT	RH	ROSFLUT	RT	RW	STORB	TD	TKP	TVR	VTK	WS	WTR
<input checked="" type="checkbox"/>	<input checked="" type="checkbox"/>	<input checked="" type="checkbox"/>	<input checked="" type="checkbox"/>	<input checked="" type="checkbox"/>	<input checked="" type="checkbox"/>	<input checked="" type="checkbox"/>	<input checked="" type="checkbox"/>	<input checked="" type="checkbox"/>	<input checked="" type="checkbox"/>	<input checked="" type="checkbox"/>	<input checked="" type="checkbox"/>	<input checked="" type="checkbox"/>	<input checked="" type="checkbox"/>	<input checked="" type="checkbox"/>	<input checked="" type="checkbox"/>	<input checked="" type="checkbox"/>	<input checked="" type="checkbox"/>

¹ Not available with 6" fluting.

ENTERTAINMENT BASE with DRAWERS, 22 1/2" HIGH, 18" DEEP	EBDB60	17.5	3180	3331	3449	3636	3854	4207	4560
--	---------------	------	------	------	------	------	------	------	------

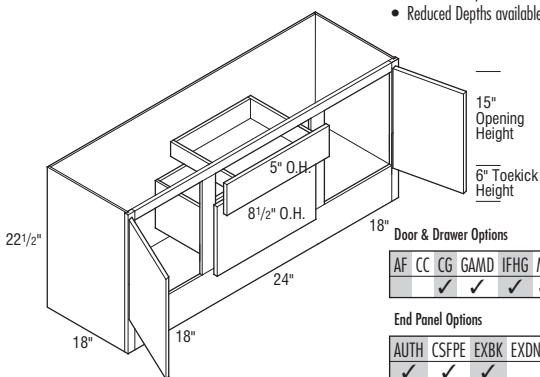

Door & Drawer Options

AF	CC	CG	GAMD	IFHG	MD	MFO	PRMD	SGLPN	SHMD	SPLITDR
<input checked="" type="checkbox"/>	<input checked="" type="checkbox"/>	<input checked="" type="checkbox"/>	<input checked="" type="checkbox"/>	<input checked="" type="checkbox"/>	<input checked="" type="checkbox"/>	<input checked="" type="checkbox"/>	<input checked="" type="checkbox"/>	<input checked="" type="checkbox"/>	<input checked="" type="checkbox"/>	<input checked="" type="checkbox"/>

End Panel Options

AUTH	CSFPE	EXBK	EXDN	FFD	FL/FR	FPE	INTGE	IPE
<input checked="" type="checkbox"/>	<input checked="" type="checkbox"/>	<input checked="" type="checkbox"/>	<input checked="" type="checkbox"/>	<input checked="" type="checkbox"/>	<input checked="" type="checkbox"/>	<input checked="" type="checkbox"/>	<input checked="" type="checkbox"/>	<input checked="" type="checkbox"/>

Custom Modification Options

ADDTK	ADRW	BVR	CBO	CCO	CFNT0	CFP	CFRMO	CLIP	CND	CSDGBK	DRWTK	EX	EX_OL	FD	FLUT ¹	FTK ²	ID	IH	INVRM
<input checked="" type="checkbox"/>	<input checked="" type="checkbox"/>	<input checked="" type="checkbox"/>	<input checked="" type="checkbox"/>	<input checked="" type="checkbox"/>	<input checked="" type="checkbox"/>	<input checked="" type="checkbox"/>	<input checked="" type="checkbox"/>	<input checked="" type="checkbox"/>	<input checked="" type="checkbox"/>	<input checked="" type="checkbox"/>	<input checked="" type="checkbox"/>	<input checked="" type="checkbox"/>	<input checked="" type="checkbox"/>	<input checked="" type="checkbox"/>	<input checked="" type="checkbox"/>	<input checked="" type="checkbox"/>	<input checked="" type="checkbox"/>	<input checked="" type="checkbox"/>	<input checked="" type="checkbox"/>

IW	MIP	OBRB	PFINBTMB	RD	RECTK	RECTKERT	RH	ROSFLUT	RT	RW	STORB	TD	TKP	TVR	VTK	WS	WTR
<input checked="" type="checkbox"/>	<input checked="" type="checkbox"/>	<input checked="" type="checkbox"/>	<input checked="" type="checkbox"/>	<input checked="" type="checkbox"/>	<input checked="" type="checkbox"/>	<input checked="" type="checkbox"/>	<input checked="" type="checkbox"/>	<input checked="" type="checkbox"/>	<input checked="" type="checkbox"/>	<input checked="" type="checkbox"/>	<input checked="" type="checkbox"/>	<input checked="" type="checkbox"/>	<input checked="" type="checkbox"/>	<input checked="" type="checkbox"/>	<input checked="" type="checkbox"/>	<input checked="" type="checkbox"/>	<input checked="" type="checkbox"/>

¹ Not available with 6" fluting.

² Only available with FTKAV and style B-L.

IH/RH availability charts starting on page G-40.
IW/RW availability charts starting on page G-46.

**ENTERTAINMENT BOX COLUMN FILLER,
22 1/2" HIGH, 15" DEEP**

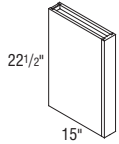

Cubic Feet	1	2	3	4	5	6	7
EBCF322.5	1.1	656	656	656	656	656	656

- Flush Toekick and Flush Panel Ends standard.
- Reversible, may be used on either left or right end.
- Front and both sides finished, back is unfinished.
- Enclosed top and bottom.
- Increased Depths available in 1/4" increments from 15 1/4" to 30".
- Reduced Depths available in 1/4" increments from 9" to 14 3/4".
- Not intended for use horizontally as shelving. Use Floating Shelves on page R•22.

Door & Drawer Options

AF	CC	CG	GAMD	IFHG	MD	MFO	PRMD	SGLPN	SHMD	SPLITDR
----	----	----	------	------	----	-----	------	-------	------	---------

End Panel Options

AUTH	CSFPE	EXBK	EXDN	FFD	FL/FR	FPE	INTGE	IPE
------	-------	------	------	-----	-------	-----	-------	-----

Custom Modification Options

ADDTK	ADRW	BVR	CBO	CCO	CFNTD	CFP	CFRMO	CLIP	CND	CSDGBK	DRWTK	EX	EX_OL	FD	FLUT ¹	FTK	ID	IH	INVERM
-------	------	-----	-----	-----	-------	-----	-------	------	-----	--------	-------	----	-------	----	-------------------	-----	----	----	--------

IW	MIP	OBRB	PFINBTMB	RD	RECTK	RECTKFRT	RH	ROSLUT	RT	RW	STORB	TD	TKP	TVR	VTK	WS	WTR
----	-----	------	----------	----	-------	----------	----	--------	----	----	-------	----	-----	-----	-----	----	-----

¹ Not available with 6" fluting.

**ENTERTAINMENT BOX COLUMN FILLER,
27" HIGH, 18" DEEP**

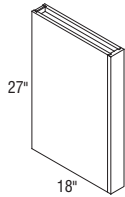

Cubic Feet	1	2	3	4	5	6	7
EBCF327	2.1	696	696	696	696	696	696

- Flush Toekick and Flush Panel Ends standard.
- Reversible, may be used on either left or right end.
- Front and both sides finished, back is unfinished.
- Enclosed top and bottom.
- Increased Depths available in 1/4" increments from 18 1/4" to 30".
- Reduced Depths available in 1/4" increments from 9" to 17 3/4".
- Not intended for use horizontally as shelving. Use Floating Shelves on page R•22.

Door & Drawer Options

AF	CC	CG	GAMD	IFHG	MD	MFO	PRMD	SGLPN	SHMD	SPLITDR
----	----	----	------	------	----	-----	------	-------	------	---------

End Panel Options

AUTH	CSFPE	EXBK	EXDN	FFD	FL/FR	FPE	INTGE	IPE
------	-------	------	------	-----	-------	-----	-------	-----

Custom Modification Options

ADDTK	ADRW	BVR	CBO	CCO	CFNTD	CFP	CFRMO	CLIP	CND	CSDGBK	DRWTK	EX	EX_OL	FD	FLUT ¹	FTK	ID	IH	INVERM
-------	------	-----	-----	-----	-------	-----	-------	------	-----	--------	-------	----	-------	----	-------------------	-----	----	----	--------

IW	MIP	OBRB	PFINBTMB	RD	RECTK	RECTKFRT	RH	ROSLUT	RT	RW	STORB	TD	TKP	TVR	VTK	WS	WTR
----	-----	------	----------	----	-------	----------	----	--------	----	----	-------	----	-----	-----	-----	----	-----

¹ Not available with 6" fluting.

**SQUARE FOOT,
3 3/4" x 3 3/4" x 4" HIGH**

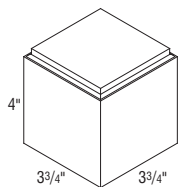

Cubic Feet	1	2	3	4	5	6	7
SMSQFOOT	0.3	305	305	305	305	305	305

- 3 3/4" W x 4" H x 3 3/4" D.
- Glazes and/or Techniques available: F, P, HW, XHW.
- Not available in Walnut.

Modifications
Are Not
Available

Glazes and Techniques
F = Flooded (see page E•4.)
P = Penned (see page E•4.)
TW = Timeworn (see page E•4.)
XTW = Extra Timeworn (see page E•4.)
HW = Hewn (see page E•4.)
XHW = Extra Hewn (see page E•4.)

Entertainment Centers

	Cubic Feet	1	2	3	4	5	6	7
ENTERTAINMENT TOPPER, 3/4" THICK, 10" DEEP	ET13	0.8	62	62	62	62	62	62

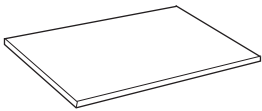

- If special sizing is required, order 3/4VEN2S.
- Top and bottom finished standard.
- All edges banded.

Modifications Are Not Available

	Cubic Feet	1	2	3	4	5	6	7
ENTERTAINMENT TOPPER, 3/4" THICK, 19" DEEP	ET19	2.2	169	169	169	169	169	169

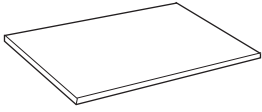

- If special sizing is required, order 3/4VEN2S.
- Top and bottom finished standard.
- All edges banded.

Modifications Are Not Available

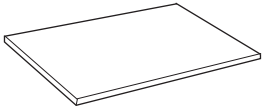

	Cubic Feet	1	2	3	4	5	6	7
ENTERTAINMENT PLATFORM, 3/4" THICK, 22" DEEP	EP49	6.8	497	497	497	497	497	497
	EP73	11.6	738	738	738	738	738	738



- If special sizing is required, order 3/4VEN2S.
- Top and bottom finished standard.
- All edges banded.

Modifications Are Not Available

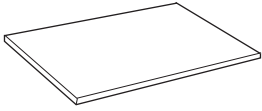
	Cubic Feet	1	2	3	4	5	6	7
ENTERTAINMENT WOOD TOPS with BEVELED EDGE, 1 1/2" THICK	3TWT4922BE	10.4	563	563	563	563	563	563
	1TWT5416BE	10.6	574	574	574	574	574	574
	2TWT54.516BE	12.2	582	582	582	582	582	582
	3TWT5516BE	14.1	587	587	587	587	587	587
	3TWT6119BE	19.1	773	773	773	773	773	773
	3TWT7322BE	27.1	1069	1069	1069	1069	1069	1069
	3TWT8519BE	31.4	1074	1074	1074	1074	1074	1074

Beveled

- Profiled on 3 sides except 1TWT5416BE and 2TWT54.516BE. See chart below.
- If Increased or Reduced Width or Increased or Reduced Depth is required, order WOODTOPBE.

Code	Profiled Sides	Side Details	Dimensions
3TWT4922BE	3 sides	Front, Left, Right	1 1/2" x 49" x 22"
1TWT5416BE	1 side	Front	1 1/2" x 54" x 16"
2TWT54.516BE	2 sides: 1 long, 1 short	Front, Left	1 1/2" x 54 1/2" x 16"
3TWT5516BE	3 sides	Front, Left, Right	1 1/2" x 55" x 16"
3TWT6119BE	3 sides	Front, Left, Right	1 1/2" x 61" x 19"
3TWT7322BE	3 sides	Front, Left, Right	1 1/2" x 73" x 22"
3TWT8519BE	3 sides	Front, Left, Right	1 1/2" x 85" x 19"

Modifications Are Not Available

IH/RH availability charts starting on page G•40.
IW/RW availability charts starting on page G•46.

ENTERTAINMENT WOOD TOPS with OGEE EDGE, 1 1/2" THICK

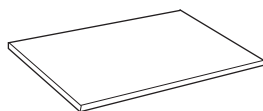

Ogee

	Cubic Feet	1	2	3	4	5	6	7
3TWT4922OG	10.4	563	563	563	563	563	563	563
1TWT5416OG	10.6	574	574	574	574	574	574	574
2TWT54.516OG	12.2	582	582	582	582	582	582	582
3TWT5516OG	14.1	587	587	587	587	587	587	587
3TWT6119OG	19.1	773	773	773	773	773	773	773
3TWT7322OG	27.1	1069	1069	1069	1069	1069	1069	1069
3TWT8519OG	31.4	1074	1074	1074	1074	1074	1074	1074

- Profiled on 3 sides except 1TWT5416OG and 2TWT54.516OG. See chart below.
- If Increased or Reduced Width or Increased or Reduced Depth is required, order WOODTOPOG.

Code	Profiled Sides	Side Details	Dimensions
3TWT4922OG	3 sides	Front, Left, Right	1 1/2" x 49" x 22"
1TWT5416OG	1 side	Front	1 1/2" x 54" x 16"
2TWT54.516OG	2 sides: 1 long, 1 short	Front, Left	1 1/2" x 54 1/2" x 16"
3TWT5516OG	3 sides	Front, Left, Right	1 1/2" x 55" x 16"
3TWT6119OG	3 sides	Front, Left, Right	1 1/2" x 61" x 19"
3TWT7322OG	3 sides	Front, Left, Right	1 1/2" x 73" x 22"
3TWT8519OG	3 sides	Front, Left, Right	1 1/2" x 85" x 19"

Modifications
Are Not
Available

ENTERTAINMENT WOOD TOPS with ROUND OVER EDGE, 1 1/2" THICK

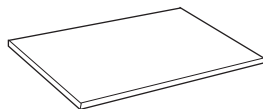

Round Over

	Cubic Feet	1	2	3	4	5	6	7
3TWT4922RO	10.4	563	563	563	563	563	563	563
1TWT5416RO	10.6	574	574	574	574	574	574	574
2TWT54.516RO	12.2	582	582	582	582	582	582	582
3TWT5516RO	14.1	587	587	587	587	587	587	587
3TWT6119RO	19.1	773	773	773	773	773	773	773
3TWT7322RO	27.1	1069	1069	1069	1069	1069	1069	1069
3TWT8519RO	31.4	1074	1074	1074	1074	1074	1074	1074

- Profiled on 3 sides except 1TWT5416RO and 2TWT54.516RO. See chart below.
- If Increased or Reduced Width or Increased or Reduced Depth is required, order WOODTOPRO.

Code	Profiled Sides	Side Details	Dimensions
3TWT4922RO	3 sides	Front, Left, Right	1 1/2" x 49" x 22"
1TWT5416RO	1 side	Front	1 1/2" x 54" x 16"
2TWT54.516RO	2 sides: 1 long, 1 short	Front, Left	1 1/2" x 54 1/2" x 16"
3TWT5516RO	3 sides	Front, Left, Right	1 1/2" x 55" x 16"
3TWT6119RO	3 sides	Front, Left, Right	1 1/2" x 61" x 19"
3TWT7322RO	3 sides	Front, Left, Right	1 1/2" x 73" x 22"
3TWT8519RO	3 sides	Front, Left, Right	1 1/2" x 85" x 19"

Modifications
Are Not
Available

Entertainment Centers

ENTERTAINMENT WOOD TOPS with SQUARE EDGE, 1 1/2" THICK

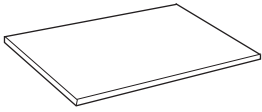

Square

	Cubic Feet	1	2	3	4	5	6	7
3TWT4922SE	10.4	563	563	563	563	563	563	563
1TWT5416SE	10.6	574	574	574	574	574	574	574
2TWT54.516SE	12.2	582	582	582	582	582	582	582
3TWT5516SE	14.1	587	587	587	587	587	587	587
3TWT6119SE	19.1	773	773	773	773	773	773	773
3TWT7322SE	27.1	1069	1069	1069	1069	1069	1069	1069
3TWT8519SE	31.4	1074	1074	1074	1074	1074	1074	1074

- Profiled on 3 sides except 1TWT5416SE and 2TWT54.516SE. See chart below.
- If Increased or Reduced Width or Increased or Reduced Depth is required, order WOODTOPSE.

Code	Profiled Sides	Side Details	Dimensions
3TWT4922SE	3 sides	Front, Left, Right	1 1/2" x 49" x 22"
1TWT5416SE	1 side	Front	1 1/2" x 54" x 16"
2TWT54.516SE	2 sides: 1 long, 1 short	Front, Left	1 1/2" x 54 1/2" x 16"
3TWT5516SE	3 sides	Front, Left, Right	1 1/2" x 55" x 16"
3TWT6119SE	3 sides	Front, Left, Right	1 1/2" x 61" x 19"
3TWT7322SE	3 sides	Front, Left, Right	1 1/2" x 73" x 22"
3TWT8519SE	3 sides	Front, Left, Right	1 1/2" x 85" x 19"

Modifications
Are Not
Available

IH/RH availability charts starting on page G•40.
IW/RW availability charts starting on page G•46.

DAVIS COLLECTION A, 49" x 24 1/4" x 22"

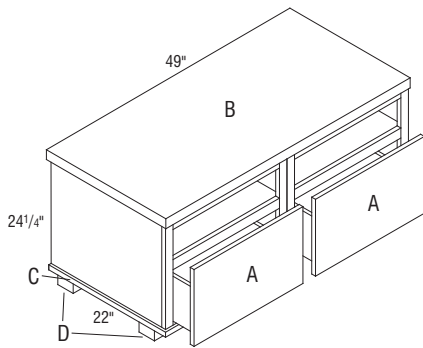

Parts Required	Quantity	Size
(A) EOD24	2	24" x 18" x 21"
(B) 3TWT4922	1	1 1/2" x 49" x 22"
(C) EP49	1	3/4" x 49" x 22"
(D) SMSQFOOT	4	3 3/4" x 3 3/4" x 4"

DAVIS COLLECTION B, 73" x 24 1/4" x 22"

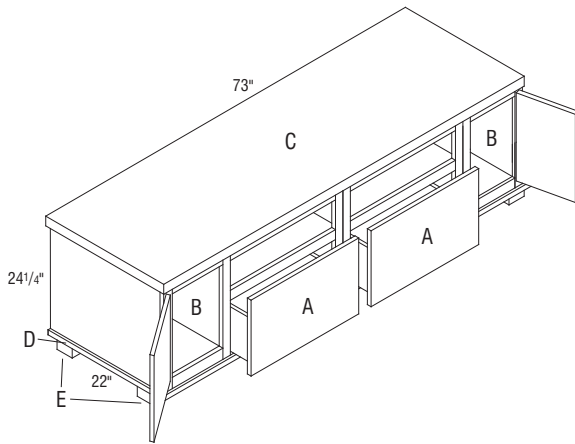

Parts Required	Quantity	Size
(A) EOD24	2	24" x 18" x 21"
(B) EB12NTK L or R	2	12" x 18" x 21"
(C) 3TWT7322	1	1 1/2" x 73" x 22"
(D) EP73	1	3/4" x 73" x 22"
(E) SMSQFOOT	6	3 3/4" x 3 3/4" x 4"

DAVIS COLLECTION C, 73" x 61" x 22"

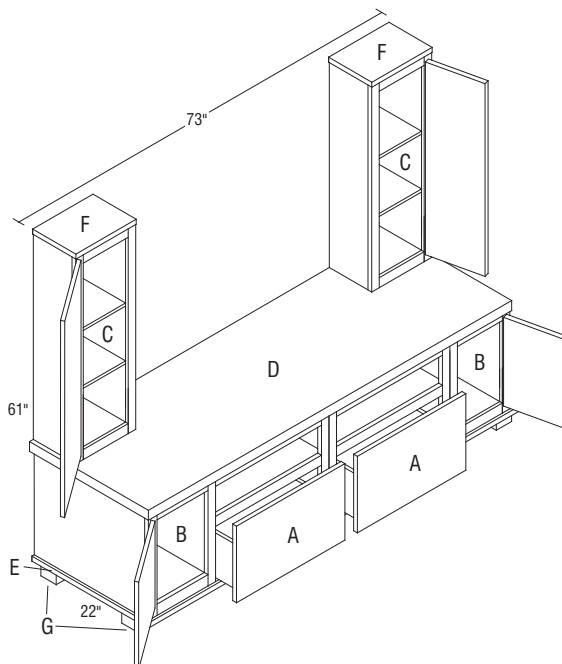

Parts Required	Quantity	Size
(A) EOD24	2	24" x 18" x 21"
(B) EB12NTK L or R	2	12" x 18" x 21"
(C) EW1236 L or R	2	12" x 36" x 9"
(D) 3TWT7322	1	1 1/2" x 73" x 22"
(E) EP73	1	3/4" x 73" x 22"
(F) ET13	2	3/4" x 13" x 10"
(G) SMSQFOOT	6	3 3/4" x 3 3/4" x 4"

Entertainment Centers

HUDSON COLLECTION A, 55" x 24" x 16"

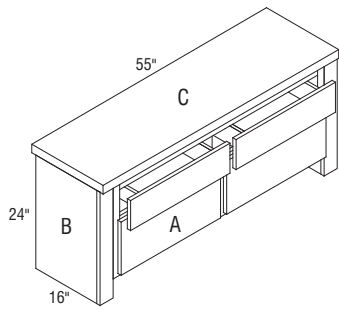

Parts Required	Quantity	Size
(A) 4EDB48NTK	1	48" x 18" x 15"
(B) EBCF322.5	2	3" x 22 1/2" x 15"
(C) 3TWT5516	1	1 1/2" x 55" x 16"

HUDSON COLLECTION B, 73" x 59 1/4" x 19"

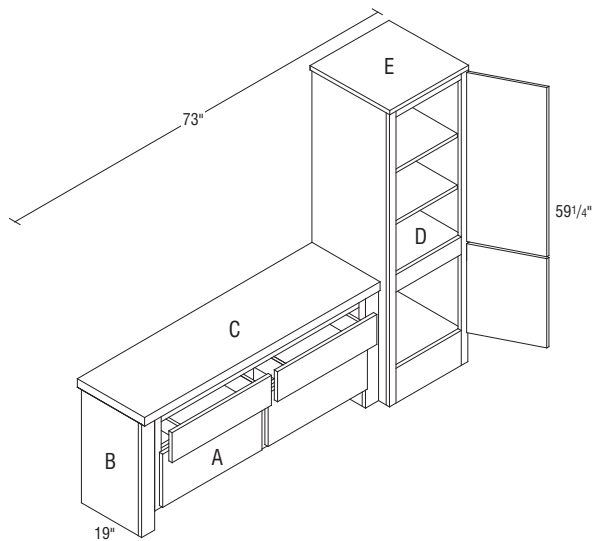

Parts Required	Quantity	Size
(A) 4EDB48NTK	1	48" x 18" x 15"
(B) EBCF322.5	2	3" x 22 1/2" x 15"
(C) 2TWT54.516	1	1 1/2" x 54 1/2" x 16"
(D) ESTW1858.5 L or R	1	18" x 58 1/2" x 18"
(E) ET19	1	3/4" x 19" x 19"

HUDSON COLLECTION C, 91" x 59 1/4" x 19"

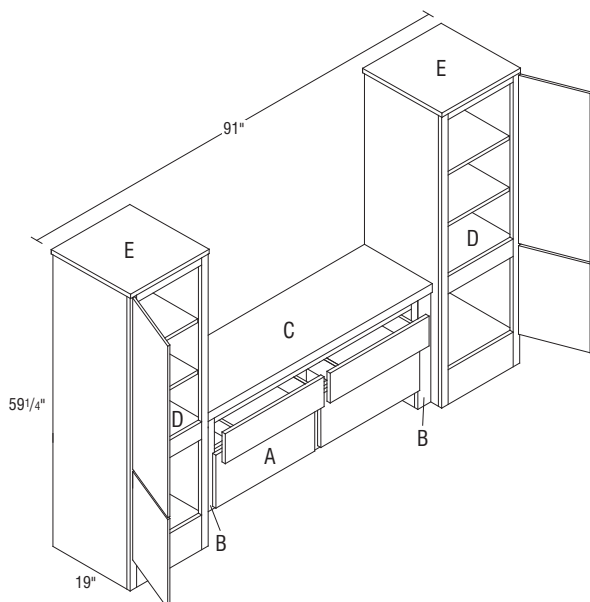

Parts Required	Quantity	Size
(A) 4EDB48NTK	1	48" x 18" x 15"
(B) EBCF322.5	2	3" x 22 1/2" x 15"
(C) 1TWT5416	1	1 1/2" x 54" x 16"
(D) ESTW1858.5 L or R	2	18" x 58 1/2" x 18"
(E) ET19	2	3/4" x 19" x 19"

HUDSON COLLECTION D, 61" x 28 1/2" x 19"

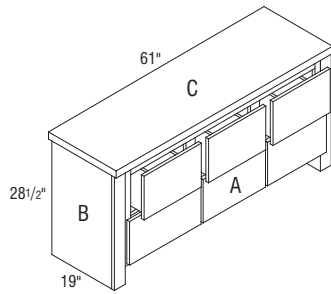

Parts Required	Quantity	Size
(A) 6EDB54	1	54" x 22 1/2" x 18"
(B) EBCF327	2	3" x 27" x 18"
(C) 3TWT6119	1	1 1/2" x 61" x 19"

BENNETT COLLECTION A, 61" x 24" x 19"

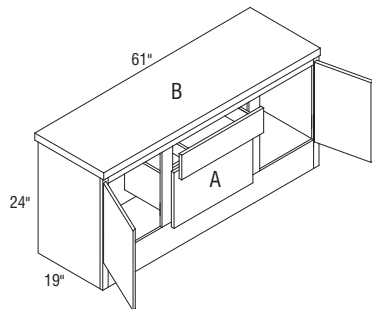

Parts Required	Quantity	Size
(A) EBDB60	1	60" x 22 1/2" x 18"
(B) 3TWT6119	1	1 1/2" x 61" x 19"

BENNETT COLLECTION B, 85" x 28 1/2" x 19"

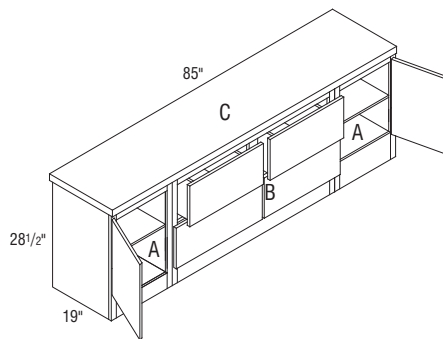

Parts Required	Quantity	Size
(A) EB18 L or R	2	18" x 27" x 18"
(B) 4EDB48	1	48" x 27" x 18"
(C) 3TWT8519	1	1 1/2" x 85" x 19"

DESK DOOR DRAWER BASE, 29" HIGH, 21" or 24" DEEP

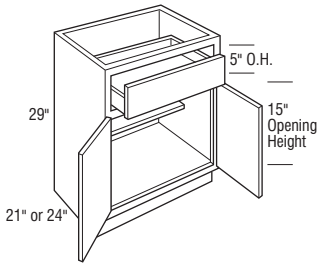
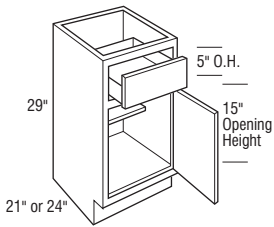

	Cubic Feet	1	2	3	4	5	6	7
DDO122921 L or R	6.4	1477	1524	1580	1666	1755	1918	2081
DDO152921 L or R	7.8	1535	1580	1637	1725	1819	1988	2157
DDO182921 L or R	9.1	1583	1632	1699	1784	1881	2056	2231
DDO212921 L or R	10.5	1636	1683	1746	1843	1944	2123	2302
DDO242921 L or R	11.9	1706	1752	1816	1917	2015	2206	2397

DDO122924 L or R	7.3	1477	1524	1580	1666	1755	1918	2081
DDO152924 L or R	8.8	1535	1580	1637	1725	1819	1988	2157
DDO182924 L or R	10.2	1583	1632	1699	1784	1881	2056	2231
DDO212924 L or R	11.8	1636	1683	1746	1843	1944	2123	2302
DDO242924 L or R	13.4	1706	1752	1816	1917	2015	2206	2397

DDO242921	11.9	1816	1868	1938	2046	2158	2357	2556
DDO272921	12.0	1979	2036	2112	2230	2352	2569	2786
DDO302921	13.2	2157	2219	2302	2431	2564	2800	3036
DDO332921	14.4	2243	2308	2394	2528	2667	2912	3157
DDO362921	15.7	2333	2400	2490	2629	2774	3028	3282
DDO242924	13.4	1816	1868	1938	2046	2158	2357	2556
DDO272924	13.5	1979	2036	2112	2230	2352	2569	2786
DDO302924	14.9	2157	2219	2302	2431	2564	2800	3036
DDO332924	16.3	2243	2308	2394	2528	2667	2912	3157
DDO362924	17.7	2333	2400	2490	2629	2774	3028	3282

- Reduced Depths available in 1/4" increments from 12" to 23 3/4".
- Includes one adjustable 15" deep shelf.
- Fronts will not align with the 5" flush toekick Desk Cabinets.
- Base Shoe Moulding (BSM, BBM8) is not recommended.

Door & Drawer Options

AF	CC	CG	GAMD	IFHG	MD	MFO	PRWD ¹	SGLPN	SHMD	SPLITDR
✓	✓	✓	✓	✓	✓	✓	✓	✓	✓	✓

End Panel Options

AUTH	CSFPE	EXBK	EXDN	FFD	FL/FR	FPE	INTGE	IPE
✓	✓	✓	✓	✓	✓	✓	✓	✓

Custom Modification Options

ADDTK	ADRW	BVR	CBO	CCO	CFNT0	CFP	CFRMO	CLIP ²	CND	CSDGBK	DRWTK ¹	EX	EX_OL	FD	FLUT ³	FTK	ID	IH	INVERM
✓	✓	✓	✓	✓	✓	✓	✓	✓	✓	✓	✓	✓	✓	✓	✓	✓	✓	✓	✓
IW	MIP	OBRB	PFINBTMB	RD	RECTK	RECTKFRT	RH	ROSFLUT	RT	RW	STORB	TD	TKP	TVR	VTK	WS ⁴	WTR		
✓	✓	✓	✓	✓	✓	✓	✓	✓	✓	✓	✓	✓	✓	✓	✓	✓	✓		

¹ Not available on 12" wide.

² Not available on 12" wide.

³ 6" fluting not available on 12" or 15" wide. Fluting both 6" also not available on 18" or 21" wide.

⁴ Wide stile both 3" not available on 12" wide.

IH/RH availability charts starting on page G•40.
IW/RW availability charts starting on page G•46.

DESK OFFICE BASE with FULL HEIGHT DOORS, 29" HIGH, 24" DEEP

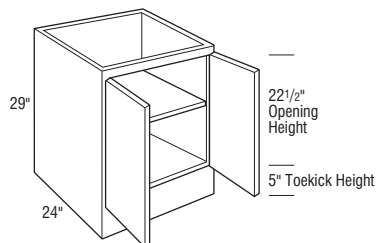
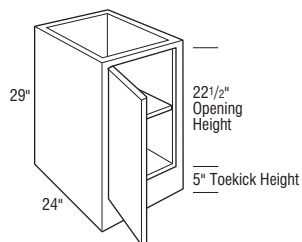

	Cubic Feet	1	2	3	4	5	6	7
DO122924FH L or R	6.3	1242	1303	1350	1418	1505	1645	1785
DO152924FH L or R	7.7	1313	1383	1431	1503	1597	1741	1885
DO182924FH L or R	9.1	1422	1466	1522	1605	1688	1848	2008
DO212924FH L or R	10.5	1476	1549	1605	1687	1789	1954	2119
DO242924FH L or R	11.9	1576	1655	1712	1802	1913	2088	2263

DO242924FH	11.9	1869	1960	2030	2134	2265	2471	2677
DO272924FH	13.3	1990	2091	2163	2277	2416	2641	2866
DO302924FH	14.7	2068	2175	2248	2369	2511	2741	2971
DO332924FH	16.1	2139	2248	2326	2452	2594	2836	3078
DO362924FH	17.5	2222	2331	2415	2540	2695	2943	3191

Notes below apply to all products in section above:

- Flush Toekick standard.
- Increased Depths available in 1/4" increments from 24 1/4" to 30".
- Reduced Depths available from 1/4" increments from 6" to 23 3/4".
- The cabinet's toekick will not align with standard base and vanity cabinets, and will not align with the 4 1/2" recessed toekick Desk Cabinets.
- Base Shoe Moulding (BSM, BBM8) is not recommended.

Door & Drawer Options

AF	CC	CG	GAMD	IFHG	MD	MFO	PRMD ¹	SGLPN	SHMD	SPLITDR ²
✓	✓	✓	✓	✓	✓	✓	✓	✓	✓	✓

End Panel Options

AUTH	CSFPE	EXBK	EXDN	FFD	FL/FR	FPE	INTGE	IPE
✓	✓	✓	✓	✓	✓	✓	✓	✓

Custom Modification Options

ADDTK	ADRW	BVR	CBO	CCO	CFNTO	CFP	CFRMO	CLIP ³	CND	CSDGBK	DRWTK	EX	EX_OL	FD	FLUT ⁴	FTK	ID	IH	INVFRM
✓	✓	✓	✓	✓	✓	✓	✓	✓	✓	✓	✓	✓	✓	✓	✓	✓	✓	✓	✓

IW	MIP	OBRB	PFINBTMB	RD	RECTK	RECTKFRT	RH	ROSFLUT	RT	RW	STORB	TD	TKP	TVR	VTK	WS ⁵	WTR
✓	✓	✓	✓	✓	✓	✓	✓	✓	✓	✓	✓	✓	✓	✓	✓	✓	✓

¹ Not available on 12" wide.

² Not available on 12" to 24" (1 door) wide.

³ Not available on 12" or 24" (2 doors) wide.

⁴ 6" fluting not available on 12", 15" or 24" (2 doors) wide. Fluting both 6" also not available with 18" or 21" wide.

⁵ Not available on 24" (2 doors) wide. Wide stile both 3" also not available on 12" wide.

DESK DRAWER BASE, 29" HIGH, 21" or 24" DEEP

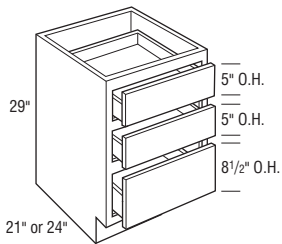

	Cubic Feet	1	2	3	4	5	6	7
DDR122921	6.4	1816	1904	1972	2079	2203	2404	2605
DDR152921	7.8	1904	1996	2068	2180	2309	2520	2731
DDR182921	9.1	1982	2078	2152	2269	2404	2623	2842
DDR212921	10.5	2064	2164	2241	2363	2503	2732	2961
DDR242921	11.9	2140	2243	2324	2450	2595	2832	3069
DDR272921	12.0	2311	2423	2510	2646	2803	3059	3315
DDR302921	13.2	2496	2617	2711	2858	3028	3305	3582
DDR332921	14.4	2695	2826	2927	3086	3269	3568	3867
DDR362921	15.7	2912	3052	3162	3333	3531	3854	4177
DDR122924	7.3	1859	1949	2019	2128	2255	2461	2667
DDR152924	8.8	1949	2043	2116	2231	2364	2580	2796
DDR182924	10.2	2029	2127	2203	2323	2460	2685	2910
DDR212924	11.8	2111	2213	2292	2416	2560	2794	3028
DDR242924	13.4	2190	2297	2379	2508	2657	2900	3143
DDR272924	13.5	2366	2480	2569	2709	2869	3132	3395
DDR302924	14.9	2555	2679	2774	2925	3099	3382	3665
DDR332924	16.3	2760	2893	2997	3159	3347	3653	3959
DDR362924	17.7	2980	3124	3236	3411	3614	3944	4274

- Reduced Depths available in 1/4" increments from 12" to 23 3/4".
- Fronts will not align with the 5" flush toe-kick Desk Cabinets.

Door & Drawer Options

AF	CC	CG	GAMD	IFHG	MD	MFO	PRMD	SGLPN	SHMD	SPLITDR

End Panel Options

AUTH	CSFPE	EXBK	EXDN	FFD	FL/FR	FPE	INTGE	IPE
✓	✓	✓	✓	✓	✓	✓	✓	✓

Custom Modification Options

ADDTK	ADRW	BVR	CBO	CCO	CFNT0	CFP	CFRMO	CLIP	CND	CSDGBK	DRWTK	EX	EX_OL	FD	FLUT ¹	FTK ²	ID	IH	INVRM	

IW ³	MIP	OBRB	PFINBTMB	RD	RECTK	RECTKFR	RH	ROSLUT	RT	RW	STORB	TD	TKP	TVR	VTK	WS	WTR
✓	✓	✓	✓	✓	✓	✓	✓	✓	✓	✓	✓	✓	✓	✓	✓	✓	✓

- ¹ Not available with 6" fluting.
- ² Not available on 12" wide.
- ³ Not available on 36" wide.

DESK FILE DRAWER BASE, 29" HIGH, 24" DEEP

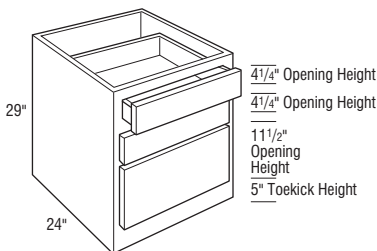

DF3D182924	9.1	2358	2423	2514	2651	2792	3050	3308
DF3D212924	10.5	2412	2480	2572	2713	2856	3122	3388
DF3D242924	11.9	2464	2534	2628	2769	2919	3187	3455

- Flush Toe-kick standard.
- Lateral Filing (Left-to-Right) system installed.
- When an Inset or Beaded Inset style is selected, drawer fronts will be slab.
- Reduced Depths available in 1/4" increments from 18" to 23 3/4".
- The cabinet's toe-kick will not align with standard base and vanity cabinets, and will not align with the 4 1/2" recessed toe-kick Desk Cabinets.
- Base Shoe Moulding (BSM, BBM8) is not recommended.

Door & Drawer Options

AF	CC	CG	GAMD	IFHG	MD	MFO	PRMD	SGLPN	SHMD	SPLITDR

End Panel Options

AUTH	CSFPE	EXBK	EXDN	FFD	FL/FR	FPE	INTGE	IPE
✓	✓	✓	✓	✓	✓	✓	✓	✓

Custom Modification Options

ADDTK	ADRW	BVR	CBO	CCO	CFNT0	CFP	CFRMO	CLIP	CND	CSDGBK	DRWTK	EX	EX_OL	FD	FLUT ¹	FTK	ID	IH	INVRM	

IW	MIP	OBRB	PFINBTMB	RD	RECTK	RECTKFR	RH	ROSLUT	RT	RW ²	STORB	TD	TKP	TVR	VTK	WS	WTR
✓	✓	✓	✓	✓	✓	✓	✓	✓	✓	✓	✓	✓	✓	✓	✓	✓	✓

- ¹ Not available with 6" fluting.
- ² Only available on 18" wide

IH/RH availability charts starting on page G•40.
IW/RW availability charts starting on page G•46.

CPU BASE, 29" HIGH, 21" or 24" DEEP

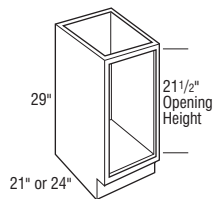

	Cubic Feet	1	2	3	4	5	6	7
CPU122921	6.4	1236	1299	1343	1414	1495	1631	1767
CPU152921	7.8	1304	1361	1408	1490	1558	1696	1834
CPU122924	7.3	1236	1299	1343	1414	1495	1631	1767
CPU152924	8.8	1304	1361	1408	1490	1558	1696	1834

- FOL shelf width is 10 9/16".
- Inset shelf width is 8 7/16".
- Fronts will not align with the 5" flush toekick Desk Cabinets.
- Grommets required for proper ventilation.
- Reduced Depths available in 3" increments to 21".
- Base Shoe Moulding (BSM, BMB8) is not recommended.

Door & Drawer Options

AF	CC	CG	GAMD	IFHG	MD	MFO	PRMD	SGLPN	SHMD	SPLITDR
	✓	✓		✓		✓		✓		✓

End Panel Options

AUTH ¹	CSFPE	EXBK	EXDN	FFD	FL/FR	FPE	INTGE	IPE
✓	✓	✓			✓	✓		✓

Custom Modification Options

ADDTK	ADRW	BVR	CBO	CCO	CFNTD	CFP	CFRMO	CLIP	CND	CSDGBK	DRWTK	EX	EX_OL	FD	FLUT ²	FTK	ID	IH	INVERM
			✓	✓	✓	✓	✓	✓	✓			✓	✓	✓	✓				

IW	MIP	OBRB	PFINBTMB	RD	RECTK	RECTKFRT	RH	ROSFLUT	RT	RW	STORB	TD	TKP	TVR	VTK	WS	WTR
✓	✓	✓		✓				✓						✓	✓	✓	✓

¹ Only available on authentic flush ends both.

² Not available with 6" fluting.

KEYBOARD TRAY, 5" HIGH, 21" DEEP

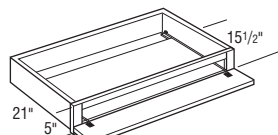
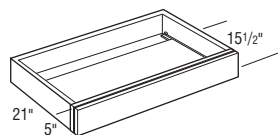

(Front tilts down, tray slides out.)

	Cubic Feet	1	2	3	4	5	6	7
KBT2421	2.2	480	480	480	480	480	480	480
KBT2721	2.5	533	533	533	533	533	533	533
KBT3021	2.7	586	586	586	586	586	586	586

- Karis and Montgomery will utilize a 5-piece drawer front, all other styles will be slab.
- Tray is 1/2" veneer MDF stained to match exterior finish.
- Tray slides out 15 1/2" and is 15 1/2" deep.
- Smart Stop feature not available.
- Not available on Inset or Beaded Inset door styles.

Door & Drawer Options

AF	CC	CG	GAMD	IFHG	MD	MFO	PRMD	SGLPN	SHMD	SPLITDR

End Panel Options

AUTH	CSFPE	EXBK	EXDN	FFD	FL/FR	FPE	INTGE	IPE
	✓	✓				✓		

Custom Modification Options

ADDTK	ADRW	BVR	CBO	CCO	CFNTD	CFP	CFRMO	CLIP	CND	CSDGBK	DRWTK	EX	EX_OL ¹	FD	FLUT ²	FTK	ID	IH	INVERM
												✓	✓	✓	✓				

IW	MIP	OBRB	PFINBTMB	RD	RECTK	RECTKFRT	RH	ROSFLUT	RT	RW	STORB	TD	TKP	TVR	VTK	WS	WTR
	✓							✓								✓	✓

¹ Not available with extended stile both.

² Not available with 6" fluting.

Bookcases

WALL BOOKCASE with ARCHED VALANCE, 48" HIGH

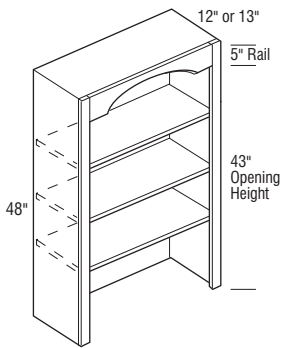

	Cubic Feet	1	2	3	4	5	6	7
W2448BCAV	10.6	1598	1598	1598	1598	1598	1598	1598
W2748BCAV	11.8	1765	1765	1765	1765	1765	1765	1765
W3048BCAV	13.1	1922	1922	1922	1922	1922	1922	1922
W3348BCAV	14.3	2095	2095	2095	2095	2095	2095	2095
W3648BCAV	15.6	2257	2257	2257	2257	2257	2257	2257
W3948BCAV	16.8	2422	2422	2422	2422	2422	2422	2422

- Matching Interior standard.
- Three adjustable shelves.
- Straight Valance is standard on Beaded Inset styles.
- Arch Valance is standard; specify Straight, style B, style D, style E, style H, style J, style K, or style L if desired.
- Style B, style D, style E, style H, style J, style K, style L, and Arch valances are not available on cabinets with frame openings less than 12" wide.
- Inset and Beaded Inset styles are a standard 13" deep.
- Full Overlay Styles:
 - Increased Depths available in 1/4" increments from 12 1/4" to 24".
 - Reduced Depths available in 1/4" increments from 6" to 11 3/4".
- Inset and Beaded Inset Styles:
 - Increased Depths available in 1/4" increments from 13 1/4" to 30".
 - Reduced Depths available in 1/4" increments from 6" to 12 3/4".

Door & Drawer Options

AF	CC	CG	GAMD	IFHG	MD	MFO	PRMD	SGLPN	SHMD	SPLITDR

End Panel Options

AUTH	CSFPE	EXBK	EXDN	FFD	FL/FR	FPE	INTGE	IPE
✓	✓	✓			✓	✓	✓	✓

Custom Modification Options

ADDTK	ADRW	BVR	CBO	CCO	CFNTO	CFP	CFRMO	CLIP	CND	CSDGBK	DRWTK	EX	EX_OL	FD	FLUT ¹	FTK	ID	IH	INVFRM
					✓			✓	✓	✓		✓	✓		✓	✓	✓		

IW ²	MIP	OBRB	PFINBTMB	RD	RECTK	RECTKFRT	RH ³	ROSLUT ⁴	RT	RW ⁵	STORB	TD	TKP	TVR ⁶	VTK	WS	WTR
✓				✓			✓	✓	✓					✓	✓	✓	✓

¹ Not available with fluting both or 6" fluting.

² Not available on 36" and 39" wide.

³ Not available on 24" wide.

⁴ Not available with fluting both.

⁵ Only available on 24" wide.

⁶ Not available on TVRAV.

IH/RH availability charts starting on page G•40.
IW/RW availability charts starting on page G•46.

WALL BOOKCASE with ARCHED VALANCE, 52 1/2" HIGH

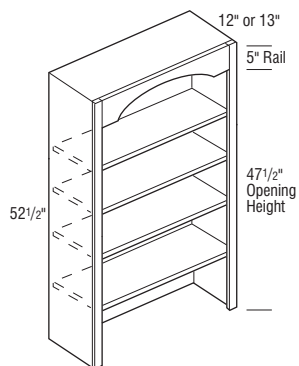

	Cubic Feet	1	2	3	4	5	6	7
W2452BCAV	11.6	1757	1757	1757	1757	1757	1757	1757
W2752BCAV	12.9	1930	1930	1930	1930	1930	1930	1930
W3052BCAV	14.3	2118	2118	2118	2118	2118	2118	2118
W3352BCAV	15.6	2303	2303	2303	2303	2303	2303	2303
W3652BCAV	17.0	2475	2475	2475	2475	2475	2475	2475
W3952BCAV	18.4	2667	2667	2667	2667	2667	2667	2667

- Matching Interior standard.
- Four adjustable shelves.
- Straight Valance is standard on Beaded Inset styles.
- Arch Valance is standard; specify Straight, style B, style D, style E, style H, style J, style K, or style L if desired.
- Style B, style D, style E, style H, style J, style K, style L, and Arch valances are not available on cabinets with frame openings less than 12" wide.
- Inset and Beaded Inset styles are a standard 13" deep.
- Full Overlay Styles:
 - Increased Depths available in 1/4" increments from 12 1/4" to 30".
 - Reduced Depths available in 1/4" increments from 6" to 11 3/4".
- Inset and Beaded Inset Styles:
 - Increased Depths available in 1/4" increments from 13 1/4" to 30".
 - Reduced Depths available in 1/4" increments from 6" to 12 3/4".

Door & Drawer Options

AF	CC	CG	GAMD	IFHG	MD	MFO	PRMD	SGLPN	SHMD	SPLITDR

End Panel Options

AUTH	CSFPE	EXBK	EXDN	FFD	FL/FR	FPE	INTGE	IPE
✓	✓	✓			✓	✓	✓	✓

Custom Modification Options

ADDTK	ADRW	BVR	CBO	CCO	CFNTD	CFP	CFRMO	CLIP	CND	CSDGBK	DRWTK	EX	EX_OL	FD	FLUT ¹	FTK	ID	IH	INVERM
					✓			✓	✓	✓	✓	✓	✓	✓	✓	✓	✓	✓	✓

IW ²	MIP	OBRB	PFINBTMB	RD	RECTK	RECTKFRT	RH ³	ROSFLUT ⁴	RT	RW ⁵	STORB	TD	TKP	TVR ⁶	VTK	WS	WTR
✓				✓			✓	✓	✓	✓	✓	✓	✓	✓	✓	✓	✓

¹ Not available with fluting both or 6" fluting.

² Not available on 36" or 39" wide.

³ Not available on 24" wide.

⁴ Not available with fluting both.

⁵ Only available on 24" wide.

⁶ Not available on TVRAV.

Bookcases

WALL BOOKCASE with ARCHED VALANCE, 60" HIGH

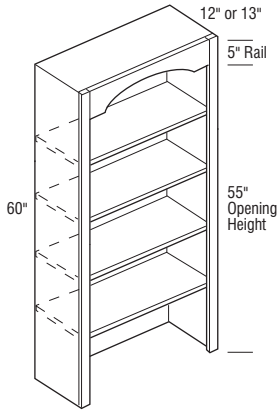

	Cubic Feet	1	2	3	4	5	6	7
W2460BCAV	13.2	1929	1929	1929	1929	1929	1929	1929
W2760BCAV	14.7	2126	2126	2126	2126	2126	2126	2126
W3060BCAV	16.3	2326	2326	2326	2326	2326	2326	2326
W3360BCAV	17.8	2526	2526	2526	2526	2526	2526	2526
W3660BCAV	19.4	2730	2730	2730	2730	2730	2730	2730
W3960BCAV	20.9	2938	2938	2938	2938	2938	2938	2938

- Matching Interior standard.
- Four adjustable shelves.
- Straight Valance is standard on Beaded Inset styles.
- Arch Valance is standard; specify Straight, style B, style D, style E, style H, style J, style K, or style L if desired.
- Style B, style D, style E, style H, style J, style K, style L, and Arch valances are not available on cabinets with frame openings less than 12" wide.
- Inset and Beaded Inset styles are a standard 13" deep.
- Full Overlay Styles:
 - Increased Depths available in 1/4" increments from 12 1/4" to 30".
 - Reduced Depths available in 1/4" increments from 6" to 11 3/4".
- Inset and Beaded Inset Styles:
 - Increased Depths available in 1/4" increments from 13 1/4" to 30".
 - Reduced Depths available in 1/4" increments from 6" to 12 3/4".

Door & Drawer Options

AF	CC	CG	GAMD	IFHG	MD	MFO	PRMD	SGLPN	SHMD	SPLITDR

End Panel Options

AUTH	CSFPE	EXBK	EXDN	FFD	FL/FR	FPE	INTGE	IPE
✓	✓	✓			✓	✓	✓	✓

Custom Modification Options

ADDTK	ADRW	BVR	CBO	CCO	CFNTD	CFP	CFRMO	CLIP	CND	CSDGBK	DRWTK	EX	EX_OL	FD	FLUT ¹	FTK	ID	IH	INVFRM
IW ²	MIP	OBRB	PFINBTMB	RD	RECTK	RECTKFRT	RH	ROSLUT ³	RT	RW ⁴	STORB	TD	TKP	TVR ⁵	VTK	WS	WTR		
✓				✓			✓	✓		✓				✓	✓	✓	✓		

¹ Not available with fluting both or 6" fluting.

² Not available on 36" or 39" wide.

³ Not available with fluting both.

⁴ Only available on 24" wide.

⁵ Not available on TVRAV.

IH/RH availability charts starting on page G•40.
IW/RW availability charts starting on page G•46.

TALL BOOKCASE with ARCHED VALANCE, 84" HIGH

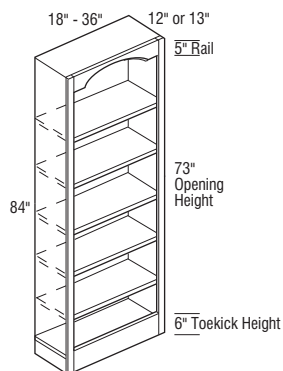

	Cubic Feet	1	2	3	4	5	6	7
T188412BCAV	14.0	2049	2049	2049	2049	2049	2049	2049
T218412BCAV	16.1	2312	2312	2312	2312	2312	2312	2312
T248412BCAV	18.3	2512	2512	2512	2512	2512	2512	2512
T278412BCAV	20.4	2764	2764	2764	2764	2764	2764	2764
T308412BCAV	22.6	3029	3029	3029	3029	3029	3029	3029
T338412BCAV	24.8	3287	3287	3287	3287	3287	3287	3287
T368412BCAV	26.9	3558	3558	3558	3558	3558	3558	3558

- Matching Interior and Flush Toekick standard.
- Five adjustable shelves.
- Straight Valance is standard on Beaded Inset styles.
- Arch Valance is standard; specify Straight, style B, style D, style E, style H, style J, style K, or style L if desired.
- Inset and Beaded Inset styles are a standard 13" deep.
- Full Overlay Styles:
 - Increased Depths available in 1/4" increments from 12 1/4" to 30".
 - Reduced Depths available in 1/4" increments from 6" to 11 3/4".
- Inset and Beaded Inset Styles:
 - Increased Depths available in 1/4" increments from 13 1/4" to 30".
 - Reduced Depths available in 1/4" increments from 6" to 12 3/4".

Door & Drawer Options

AF	CC	CG	GAMD	IFHG	MD	MFO	PRMD	SGLPN	SHMD	SPLITDR
----	----	----	------	------	----	-----	------	-------	------	---------

End Panel Options

AUTH	CSFPE	EXBK	EXDN	FFD	FL/FR	FPE	INTGE	IPE
✓	✓	✓			✓	✓	✓	✓

Custom Modification Options

ADDTK	ADRW	BVR	CBO	CCO	CFNT0	CFP	CFRMO	CLIP	CND	CSDGBK	DRWTK	EX	EX_OL	FD	FLUT ¹	FTK ²	ID	IH	INVRM
						✓	✓		✓	✓		✓	✓	✓	✓	✓	✓	✓	✓

IW ³	MIP	OBRB	PFINBTMB	RD	RECTK	RECTKFRT	RH	ROSFLOT ⁴	RT	RW ⁵	STORB	TD	TKP	TVR ⁶	VTK	WS	WTR
✓		✓		✓	✓	✓	✓	✓	✓	✓				✓	✓	✓	✓

¹ Not available with fluting both or 6" fluting.

² Only available on FTKAV and style B-L.

³ Not available on 36" wide.

⁴ Not available with fluting both.

⁵ Only available on 18" wide.

⁶ Not available on TVRAV.

Bookcases

TALL BOOKCASE with ARCHED VALANCE, 90" HIGH

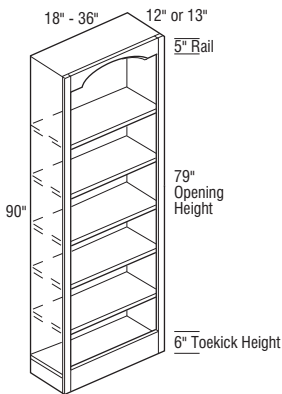

	Cubic Feet	1	2	3	4	5	6	7
T189012BCAV	15.0	2176	2176	2176	2176	2176	2176	2176
T219012BCAV	17.3	2447	2447	2447	2447	2447	2447	2447
T249012BCAV	19.6	2658	2658	2658	2658	2658	2658	2658
T279012BCAV	21.9	2933	2933	2933	2933	2933	2933	2933
T309012BCAV	24.2	3207	3207	3207	3207	3207	3207	3207
T339012BCAV	26.5	3478	3478	3478	3478	3478	3478	3478
T369012BCAV	28.8	3770	3770	3770	3770	3770	3770	3770

- Matching Interior and Flush Toe kick standard.
- Five adjustable shelves.
- Straight Valance is standard on Beaded Inset styles.
- Arch Valance is standard; specify Straight, style B, style D, style E, style H, style J, style K, or style L if desired.
- Inset and Beaded Inset styles are a standard 13" deep.
- Full Overlay Styles:
 - Increased Depths available in 1/4" increments from 12 1/4" to 30".
 - Reduced Depths available in 1/4" increments from 6" to 11 3/4".
- Inset and Beaded Inset Styles:
 - Increased Depths available in 1/4" increments from 13 1/4" to 30".
 - Reduced Depths available in 1/4" increments from 6" to 12 3/4".

Door & Drawer Options

AF	CC	CG	GAMD	IFHG	MD	MFO	PRMD	SGLPN	SHMD	SPLITDR
----	----	----	------	------	----	-----	------	-------	------	---------

End Panel Options

AUTH	CSFPE	EXBK	EXDN	FFD	FL/FR	FPE	INTGE	IPE
✓	✓	✓			✓	✓	✓	✓

Custom Modification Options

ADDTK	ADRW	BVR	CBO	CCO	CFNT0	CFP	CFRMO	CLIP	CND	CSDGBK	DRWTK	EX	EX_OL	FD	FLUT ¹	FTK ²	ID	IH	INVERM
					✓	✓		✓		✓		✓	✓		✓	✓	✓	✓	

IW ³	MIP	OBRB	PFINBTMB	RD	RECTK	RECTKFRT	RH	ROSEFLUT ⁴	RT	RW ⁵	STORB	TD	TKP	TVR ⁶	VTK	WS	WTR
✓		✓		✓	✓	✓	✓	✓	✓	✓				✓	✓	✓	✓

¹ Not available with fluting both or 6" fluting.

² Only available on FTKAV and style BL.

³ Not available on 36" wide.

⁴ Not available with fluting both.

⁵ Only available on 18" wide.

⁶ Not available on TVRAV.

IH/RH availability charts starting on page G•40.
IW/RW availability charts starting on page G•46.

TALL BOOKCASE with ARCHED VALANCE, 96" HIGH

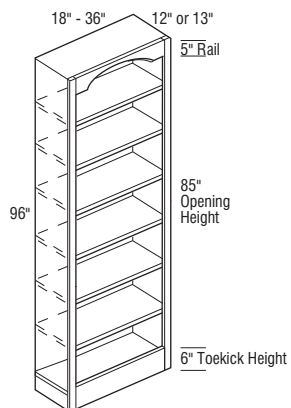

	Cubic Feet	1	2	3	4	5	6	7
T189612BCAV	16.0	2310	2310	2310	2310	2310	2310	2310
T219612BCAV	18.4	2594	2594	2594	2594	2594	2594	2594
T249612BCAV	20.9	2818	2818	2818	2818	2818	2818	2818
T279612BCAV	23.3	3110	3110	3110	3110	3110	3110	3110
T309612BCAV	25.8	3397	3397	3397	3397	3397	3397	3397
T339612BCAV	28.2	3693	3693	3693	3693	3693	3693	3693
T369612BCAV	30.7	3992	3992	3992	3992	3992	3992	3992

- Matching Interior and Flush Toekick standard.
- Six adjustable shelves.
- Straight Valance is standard on Beaded Inset styles.
- Arch Valance is standard; specify Straight, style B, style D, style E, style H, style J, style K, or style L if desired.
- Inset and Beaded Inset styles are a standard 13" deep.
- Full Overlay Styles:
 - Increased Depths available in 1/4" increments from 12 1/4" to 30".
 - Reduced Depths available in 1/4" increments from 6" to 11 3/4".
- Inset and Beaded Inset Styles:
 - Increased Depths available in 1/4" increments from 13 1/4" to 30".
 - Reduced Depths available in 1/4" increments from 6" to 12 3/4".

Door & Drawer Options

AF	CC	CG	GAMD	IFHG	MD	MFO	PRMD	SGLPN	SHMD	SPLITDR
----	----	----	------	------	----	-----	------	-------	------	---------

End Panel Options

AUTH	CSFPE	EXBK	EXDN	FFD	FL/FR	FPE	INTGE	IPE
✓	✓	✓			✓	✓	✓	✓

Custom Modification Options

ADDTK	ADRW	BVR	CBO	CCO	CFNT0	CFP	CFRMO	CLIP	CND	CSDGBK	DRWTK	EX	EX_OL	FD	FLUT ¹	FTK ²	ID	IH	INVERM
						✓	✓		✓	✓		✓	✓		✓	✓	✓		

IW ³	MIP	OBRB	PFINBTMB	RD	RECTK	RECTKFRT	RH	ROSLUT ⁴	RT	RW ⁵	STORB	TD	TKP	TVR ⁶	VTK	WS	WTR
✓		✓		✓	✓	✓	✓	✓	✓	✓				✓	✓	✓	✓

¹ Not available with fluting both or 6" fluting.

² Only available on FTKAV and style B-L.

³ Not available on 36" wide.

⁴ Not available with fluting both.

⁵ Only available on 18" wide.

⁶ Not available on TVRAV.

Bookcases

TALL BOOKCASE with DOORS and ARCHED VALANCE, 84" HIGH

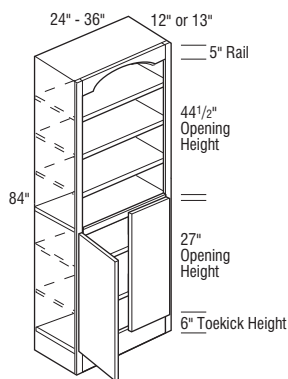
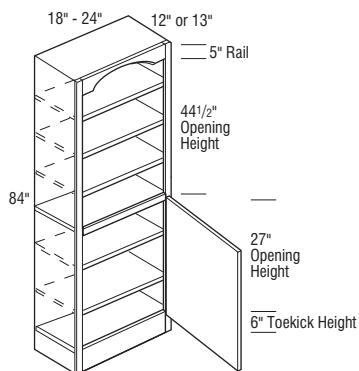

	Cubic Feet	1	2	3	4	5	6	7
TD188412BCAV L or R	14.0	2519	2644	2735	2885	3057	3337	3617
TD218412BCAV L or R	16.1	2834	2970	3078	3243	3436	3753	4070
TD248412BCAV L or R	18.3	3084	3233	3346	3528	3736	4080	4424

TD248412BCAV	18.3	3281	3438	3560	3753	3975	4341	4707
TD278412BCAV	20.4	3398	3564	3689	3887	4120	4499	4878
TD308412BCAV	22.6	3715	3896	4029	4251	4501	4918	5335
TD338412BCAV	24.8	4041	4234	4383	4624	4896	5348	5800
TD368412BCAV	26.9	4368	4580	4741	4999	5297	5784	6271

Notes below apply to all products in section above:

- Matching Interior and Flush Toe Kick standard.
- Five adjustable shelves.
- Straight Valance is standard on Beaded Inset styles.
- Arch Valance is standard; specify Straight, style B, style D, style E, style H, style J, style K, or style L if desired.
- Inset and Beaded Inset styles are a standard 13" deep.
- Full Overlay Styles:
 - Increased Depths available in 1/4" increments from 12 1/4" to 30".
 - Reduced Depths available in 1/4" increments from 6" to 11 3/4".
- Inset and Beaded Inset Styles:
 - Increased Depths available in 1/4" increments from 13 1/4" to 30".
 - Reduced Depths available in 1/4" increments from 6" to 12 3/4".

Door & Drawer Options

AF	CC	CG	GAMD	IFHG	MD	MFO ¹	PRMD	SGLPN	SHMD	SPLITDR ²
✓	✓	✓	✓	✓	✓	✓	✓	✓	✓	✓

End Panel Options

AUTH	CSFPE	EXBK	EXDN	FFD	FL/FR	FPE	INTGE	IPE
✓	✓	✓	✓	✓	✓	✓	✓	✓

Custom Modification Options

ADDTK	ADRW	BVR	CBO	CCO ³	CFNT0	CFP ⁴	CFRMO ¹	CLIP	CND ⁵	CSDGBK	DRWTK	EX	EX_OL	FD	FLUT ⁶	FTK ⁷	ID	IH	INVFRM
✓	✓	✓	✓	✓	✓	✓	✓	✓	✓	✓	✓	✓	✓	✓	✓	✓	✓	✓	✓

IW ⁸	MIP	OBRB	PFINBTMB	RD	RECTK	RECTKFR	RH	ROSLUT ⁹	RT	RW ¹⁰	STORB	TD ¹¹	TKP	TVR ¹²	VTK	WS	WTR
✓	✓	✓	✓	✓	✓	✓	✓	✓	✓	✓	✓	✓	✓	✓	✓	✓	✓

- ¹ Only available on 24" (1 door) wide.
- ² Not available on 18"-24" (1 door) wide.
- ³ Only available on 24" (1 door and 2 doors) wide.
- ⁴ Only available on 27"-36" wide.
- ⁵ Not available on 24" (1 door) wide.
- ⁶ Not available with fluting both or 6" fluting.
- ⁷ Only available on FTKAV and style B-L.
- ⁸ Not available on 24" (1 door) or 36" wide.
- ⁹ Not available with fluting both.
- ¹⁰ Only available on 18" wide.
- ¹¹ Not available on 24" (2 doors) wide.
- ¹² Not available on TVRAV.

IH/RH availability charts starting on page G-40.
IW/RW availability charts starting on page G-46.

TALL BOOKCASE with DOORS and ARCHED VALANCE, 90" HIGH

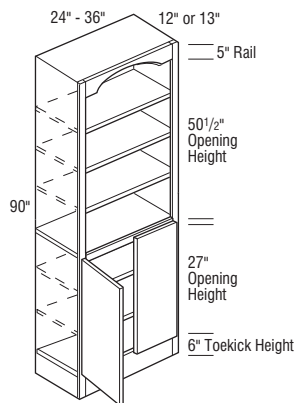
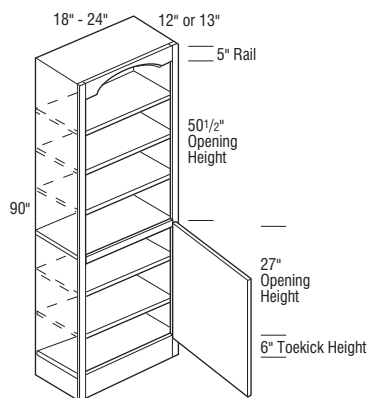

	Cubic Feet	1	2	3	4	5	6	7
TD189012BCAV L or R	15.0	2663	2792	2891	3050	3230	3528	3826
TD219012BCAV L or R	17.3	3005	3150	3261	3440	3643	3980	4317
TD249012BCAV L or R	19.6	3266	3422	3543	3735	3956	4322	4688

TD249012BCAV	19.6	3460	3627	3754	3957	4194	4580	4966
TD279012BCAV	21.9	3608	3768	3900	4111	4355	4756	5157
TD309012BCAV	24.2	3934	4126	4270	4501	4772	5210	5648
TD339012BCAV	26.5	4271	4478	4637	4889	5179	5655	6131
TD369012BCAV	28.8	4627	4848	5019	5295	5606	6121	6636

Notes below apply to all products in section above:

- Matching Interior and Flush Toe-kick standard.
- Five adjustable shelves.
- Straight Valance is standard on Beaded Inset styles.
- Arch Valance is standard; specify Straight, style B, style D, style E, style H, style J, style K, or style L if desired.
- Inset and Beaded Inset styles are a standard 13" deep.
- Full Overlay Styles:
 - Increased Depths available in 1/4" increments from 12 1/4" to 30".
 - Reduced Depths available in 1/4" increments from 6" to 11 3/4".
- Inset and Beaded Inset Styles:
 - Increased Depths available in 1/4" increments from 13 1/4" to 30".
 - Reduced Depths available in 1/4" increments from 6" to 12 3/4".

Door & Drawer Options

AF	CC	CG	GAMD	IFHG	MD	MFO ¹	PRMD	SGLPN	SHMD	SPLITDR ²

End Panel Options

AUTH	CSFPE	EXBK	EXDN	FFD	FL/FR	FPE	INTGE	IPE

Custom Modification Options

ADDTK	ADRW	BVR	CBO	CCO ³	CFNTO	CFP ⁴	CFRMO ¹	CLIP	CND ⁵	CSDGBK	DRWTK	EX	EX_QL	FD	FLUT ⁶	FTK ⁷	ID	IH	INVRM

IW ⁸	MIP	OBRB	PFINBTMB	RD	RECTK	RECTKFRT	RH	ROSEFLUT ⁹	RT	RW ¹⁰	STORB	TD ¹¹	TKP	TVR ¹²	VTK	WS	WTR

¹ Only available on 24" (1 door) wide.

² Not available on 18"-24" (1 door) wide.

³ Only available on 24" (1 door and 2 doors) wide.

⁴ Only available on 27"-36" wide.

⁵ Not available on 24" (1 door) wide.

⁶ Not available with fluting both or 6" fluting.

⁷ Only available on FTKAV and style B-L.

⁸ Not available on 24" (1 door) or 36" wide.

⁹ Not available with fluting both.

¹⁰ Only available on 18" wide.

¹¹ Not available on 24" (2 doors) wide.

¹² Not available on TVRAV.

Bookcases

TALL BOOKCASE with DOORS and ARCHED VALANCE, 96" HIGH

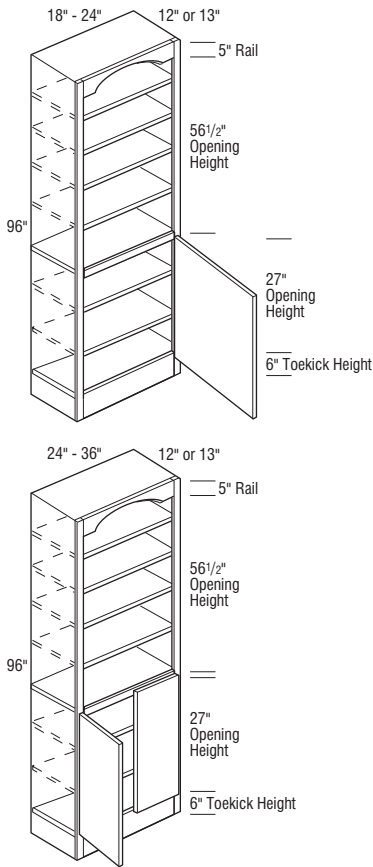

	Cubic Feet	1	2	3	4	5	6	7
TD189612BCAV L or R	16.0	2823	2961	3063	3232	3422	3736	4050
TD219612BCAV L or R	18.4	3180	3331	3449	3636	3854	4207	4560
TD249612BCAV L or R	20.9	3462	3629	3756	3960	4195	4581	4967

TD249612BCAV	20.9	3652	3828	3965	4178	4429	4836	5243
TD279612BCAV	23.3	3815	3998	4140	4366	4624	5047	5470
TD309612BCAV	25.8	4173	4373	4528	4776	5058	5523	5988
TD339612BCAV	28.2	4534	4752	4921	5188	5496	6002	6508
TD369612BCAV	30.7	4905	5140	5324	5612	5949	6493	7037

Notes below apply to all products in section above:

- Matching Interior and Flush Toe-kick standard.
- Six adjustable shelves.
- Straight Valance is standard on Beaded Inset styles.
- Arch Valance is standard; specify Straight, style B, style D, style E, style H, style J, style K, or style L if desired.
- Inset and Beaded Inset styles are a standard 13" deep.
- Full Overlay Styles:
 - Increased Depths available in 1/4" increments from 12 1/4" to 30".
 - Reduced Depths available in 1/4" increments from 6" to 11 3/4".
- Inset and Beaded Inset Styles:
 - Increased Depths available in 1/4" increments from 13 1/4" to 30".
 - Reduced Depths available in 1/4" increments from 6" to 12 3/4".

Door & Drawer Options

AF	CC	CG	GAMD	IFHG	MD	MFO ¹	PRMD	SGLPN	SHMD	SPLITDR ²
				✓		✓			✓	✓

End Panel Options

AUTH	CSFPE	EXBK	EXDN	FFD	FL/FR	FPE	INTGE	IPE
✓	✓	✓			✓	✓	✓	✓

Custom Modification Options

ADDTK	ADRW	BVR	CBO	CCO ³	CFNT0	CFP ⁴	CFRMO ¹	CLIP	CND ⁵	CSDGBK	DRWTK	EX	EX_OL	FD	FLUT ⁶	FTK ⁷	ID	IH	INVFRM	
			✓	✓	✓	✓	✓	✓	✓	✓	✓	✓	✓	✓	✓	✓	✓	✓	✓	✓

IW ⁸	MIP	OBRB	PFINBTMB	RD	RECTK	RECTKFR	RH	ROSLUT ⁹	RT	RW ¹⁰	STORB	TD ¹¹	TKP	TVR ¹²	VTK	WS	WTR
✓	✓					✓	✓	✓	✓	✓		✓	✓	✓	✓	✓	✓

- ¹ Only available on 24" (1 door) wide.
- ² Not available on 18"-24" (1 door) wide.
- ³ Only available on 24" (1 door and 2 doors) wide.
- ⁴ Only available on 27"-36" wide.
- ⁵ Not available on 24" (1 door) wide.
- ⁶ Not available with fluting both or 6" fluting.
- ⁷ Only available on FTKAV and style B-L.
- ⁸ Not available on 24" (1 door) or 36" wide.
- ⁹ Not available with fluting both.
- ¹⁰ Only available on 18" wide.
- ¹¹ Not available on 24" (2 doors) wide.
- ¹² Not available on TVRAV.

IH/RH availability charts starting on page G•40.
IW/RW availability charts starting on page G•46.

TALL BOOKCASE with VANITY HEIGHT DOORS and ARCHED VALANCE, 84" HIGH

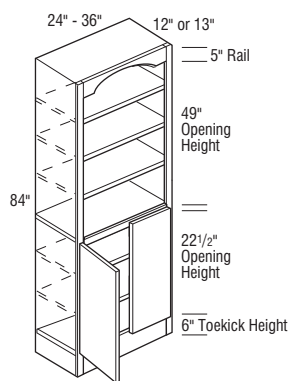
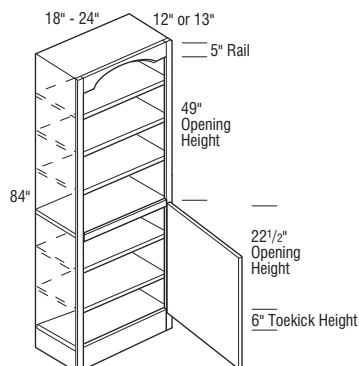

	Cubic Feet	1	2	3	4	5	6	7
TDV188412BCAV L or R	14.0	2468	2587	2678	2823	2993	3269	3545
TDV218412BCAV L or R	16.1	2785	2918	3023	3185	3377	3686	3995
TDV248412BCAV L or R	18.3	3026	3171	3282	3462	3666	4003	4340

TDV248412BCAV	18.3	3143	3293	3413	3595	3809	4159	4509
TDV278412BCAV	20.4	3340	3500	3624	3821	4049	4422	4795
TDV308412BCAV	22.6	3649	3826	3960	4175	4425	4831	5237
TDV338412BCAV	24.8	3966	4158	4304	3711	4806	5249	5692
TDV368412BCAV	26.9	4288	4494	4651	4905	5195	5676	6157

Notes below apply to all products in section above:

- Matching Interior and Flush Toe-kick standard.
- Five adjustable shelves.
- Straight Valance is standard on Beaded Inset styles.
- Arch Valance is standard; specify Straight, style B, style D, style E, style H, style J, style K, or style L if desired.
- Inset and Beaded Inset styles are a standard 13" deep.
- Full Overlay Styles:
 - Increased Depths available in 1/4" increments from 12 1/4" to 30".
 - Reduced Depths available in 1/4" increments from 6" to 11 3/4".
- Inset and Beaded Inset Styles:
 - Increased Depths available in 1/4" increments from 13 1/4" to 30".
 - Reduced Depths available in 1/4" increments from 6" to 12 3/4".

Door & Drawer Options

AF	CC	CG	GAMD	IFHG	MD	MFO ¹	PRMD	SGLPN	SHMD	SPLITDR ²

End Panel Options

AUTH	CSFPE	EXBK	EXDN	FFD	FL/FR	FPE	INTGE	IPE

Custom Modification Options

ADDTK	ADRW	BVR	CBO	CCO ³	CFNTO	CFP ⁴	CFRMO ¹	CLIP	CND ⁴	CSDGBK	DRWTK	EX	EX_OL	FD	FLUT ⁵	FTK ⁶	ID	IH	INVRM	
IW ⁷	MIP	OBRB	PFINBTMB	RD	RECTK	RECTKFRT	RH	ROSEFLUT ⁸	RT	RW ⁹	STORB	TD ¹⁰	TKP	TVR ¹¹	VTK	WS	WTR			

¹ Only available on 24" (1 door) wide.

² Only available on 27"-36" wide.

³ Only available on 24" (1 door and 2 doors) wide.

⁴ Not available on 24" (1 door) wide.

⁵ Not available with fluting both or 6" fluting.

⁶ Only available on FTKAV and style B-L.

⁷ Not available on 24" (1 door) or 36" wide.

⁸ Not available with fluting both.

⁹ Only available on 18" wide.

¹⁰ Not available on 24" (2 doors) wide.

¹¹ Not available on TVRAV.

Bookcases

TALL BOOKCASE with VANITY HEIGHT DOORS and ARCHED VALANCE, 90" HIGH

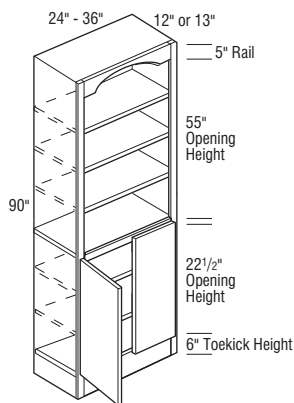
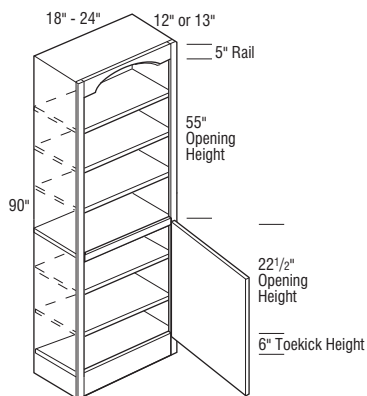

	Cubic Feet	1	2	3	4	5	6	7
TDV189012BCAV L or R	15.0	2615	2742	2837	2993	3171	3464	3757
TDV219012BCAV L or R	17.3	2948	3091	3200	3377	3574	3903	4232
TDV249012BCAV L or R	19.6	3205	3358	3478	3667	3884	4242	4600

TDV249012BCAV	19.6	3397	3563	3688	3886	4117	4496	4875
TDV279012BCAV	21.9	3527	3695	3827	4035	4274	4670	5066
TDV309012BCAV	24.2	3864	4049	4191	4420	4681	5111	5541
TDV339012BCAV	26.5	4196	4399	4553	4803	5088	5555	6022
TDV369012BCAV	28.8	4543	4761	4931	5199	5507	6013	6519

Notes below apply to all products in section above:

- Matching Interior and Flush Toe-kick standard.
- Five adjustable shelves.
- Straight Valance is standard on Beaded Inset styles.
- Arch Valance is standard; specify Straight, style B, style D, style E, style H, style J, style K, or style L if desired.
- Inset and Beaded Inset styles are a standard 13" deep.
- Full Overlay Styles:
 - Increased Depths available in 1/4" increments from 12 1/4" to 30".
 - Reduced Depths available in 1/4" increments from 6" to 11 3/4".
- Inset and Beaded Inset Styles:
 - Increased Depths available in 1/4" increments from 13 1/4" to 30".
 - Reduced Depths available in 1/4" increments from 6" to 12 3/4".

Door & Drawer Options

AF	CC	CG	GAMD	IFHG	MD	MFO ¹	PRMD	SGLPN	SHMD	SPLITDR ²
				✓		✓			✓	✓

End Panel Options

AUTH	CSFPE	EXBK	EXDN	FFD	FL/FR	FPE	INTGE	IPE
✓	✓	✓			✓	✓	✓	✓

Custom Modification Options

ADDTK	ADRW	BVR	CBO	CCO ³	CFNT0	CFP ⁴	CFRMO ¹	CLIP	CND ⁴	CSDGBK	DRWTK	EX	EX_OL	FD	FLUT ⁵	FTK ⁶	ID	IH	INVFRM	
			✓	✓	✓	✓	✓	✓	✓	✓	✓	✓	✓	✓	✓	✓	✓	✓	✓	✓

IW ⁷	MIP	OBRB	PFINBTMB	RD	RECTK	RECTKFR	RH	ROSLUT ⁸	RT	RW ⁹	STORB	TD ¹⁰	TKP	TVR ¹¹	VTK	WS	WTR
✓		✓				✓	✓	✓	✓	✓		✓	✓	✓	✓	✓	✓

- ¹ Only available on 24" (1 door) wide.
- ² Only available on 27"-36" wide.
- ³ Only available on 24" (1 door and 2 doors) wide.
- ⁴ Not available on 24" (1 door) wide.
- ⁵ Not available with fluting both or 6" fluting.
- ⁶ Only available on FTKAV and style B-L.
- ⁷ Not available on 24" (1 door) or 36" wide.
- ⁸ Not available with fluting both.
- ⁹ Only available on 18" wide.
- ¹⁰ Not available on 24" (2 doors) wide.
- ¹¹ Not available on TVRAV.

IH/RH availability charts starting on page G•40.
IW/RW availability charts starting on page G•46.

TALL BOOKCASE with VANITY HEIGHT DOORS and ARCHED VALANCE, 96" HIGH

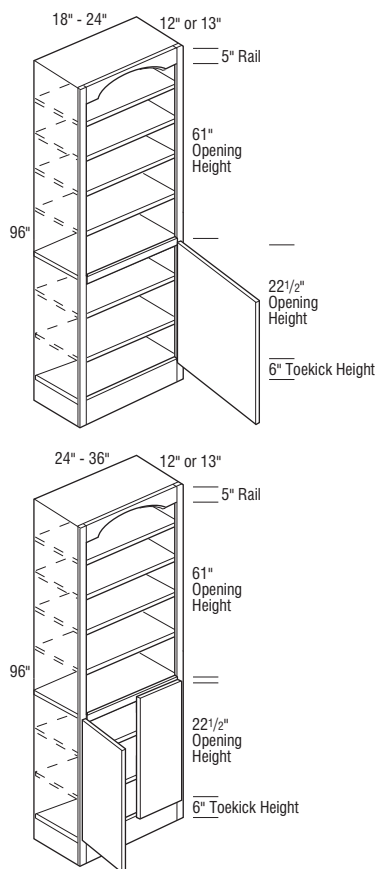

	Cubic Feet	1	2	3	4	5	6	7
TDV189612BCAV L or R	16.0	2781	2914	3018	3181	3371	3681	3991
TDV219612BCAV L or R	18.4	3127	3280	3392	3580	3790	4141	4492
TDV249612BCAV L or R	20.9	3408	3571	3695	3900	4130	4509	4888

TDV249612BCAV	20.9	3378	3537	3665	3865	4093	4468	4843
TDV279612BCAV	23.3	3742	3924	4063	4286	4538	4954	5370
TDV309612BCAV	25.8	4098	4295	4445	4688	4966	5423	5880
TDV339612BCAV	28.2	4447	4664	4828	5092	5394	5889	6384
TDV369612BCAV	30.7	4814	5045	5223	5509	5836	6374	6912

Notes below apply to all products in section above:

- Matching Interior and Flush Toe Kick standard.
- Six adjustable shelves.
- Straight Valance is standard on Beaded Inset styles.
- Arch Valance is standard; specify Straight, style B, style D, style E, style H, style J, style K, or style L if desired.
- Inset and Beaded Inset styles are a standard 13" deep.
- Full Overlay Styles:
 - Increased Depths available in 1/4" increments from 12 1/4" to 30".
 - Reduced Depths available in 1/4" increments from 6" to 11 3/4".
- Inset and Beaded Inset Styles:
 - Increased Depths available in 1/4" increments from 13 1/4" to 30".
 - Reduced Depths available in 1/4" increments from 6" to 12 3/4".

Door & Drawer Options

AF	CC	CG	GAMD	IFHG	MD	MFO ¹	PRMD	SGLPN	SHMD	SPLITDR

End Panel Options

AUTH	CSFPE	EXBK	EXDN	FFD	FL/FR	FPE	INTGE	IPE

Custom Modification Options

ADDTK	ADRW	BVR	CBO	CCO ²	CFNTO	CFP ³	CFRMO ¹	CLIP	CND ³	CSDGBK	DRWTK	EX	EX_OL	FD	FLUT ⁴	FTK ⁵	ID	IH	INVRM
IW ⁶	MIP	OBRB	PFINBTMB	RD	RECTK	RECTKFRT	RH	ROSEFLUT ⁷	RT	RW ⁸	STORB	TD ⁹	TKP	TVR ¹⁰	VTK	WS	WTR		

¹ Only available on 24" (1 door) wide.

² Only available on 24" (1 door and 2 doors) wide.

³ Not available on 24" (1 door) wide.

⁴ Not available with fluting both or 6" fluting.

⁵ Only available on FTKAV and style B-L.

⁶ Not available on 24" (1 door) or 36" wide.

⁷ Not available with fluting both.

⁸ Only available on 18" wide.

⁹ Not available on 24" (2 doors) wide.

¹⁰ Not available on TVRAV.

Bookcases

TALL BOOKCASE with OFFICE HEIGHT DOORS and ARCHED VALANCE, 84" HIGH

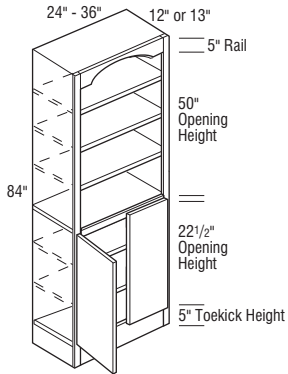
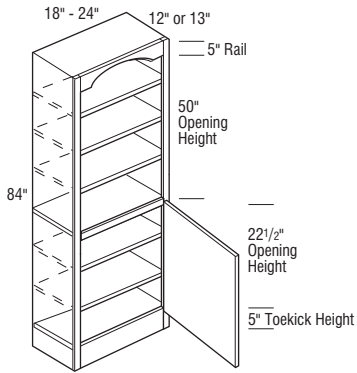

	Cubic Feet	1	2	3	4	5	6	7
TDO188412BCAV L or R	14.0	2468	2587	2678	2823	2993	3269	3545
TDO218412BCAV L or R	16.1	2785	2918	3023	3185	3377	3686	3995
TDO248412BCAV L or R	18.3	3026	3171	3282	3462	3666	4003	4340

TDO248412BCAV	18.3	3143	3293	3413	3595	3809	4159	4509
TDO278412BCAV	20.4	3340	3500	3624	3821	4049	4422	4795
TDO308412BCAV	22.6	3649	3826	3960	4175	4425	4831	5237
TDO338412BCAV	24.8	3966	4158	4304	4511	4806	5249	5692
TDO368412BCAV	26.9	4288	4494	4651	4905	5195	5676	6157

Notes below apply to all products in section above:

- Matching Interior and Flush Toe Kick standard.
- Five adjustable shelves.
- Straight Valance is standard on Beaded Inset styles.
- Arch Valance is standard; specify Straight, style B, style D, style E, style H, style J, style K, or style L if desired.
- Inset and Beaded Inset styles are a standard 13" deep.
- Full Overlay Styles:
 - Increased Depths available in 1/4" increments from 12 1/4" to 30".
 - Reduced Depths available in 1/4" increments from 6" to 11 3/4".
- Inset and Beaded Inset Styles:
 - Increased Depths available in 1/4" increments from 13 1/4" to 30".
 - Reduced Depths available in 1/4" increments from 6" to 12 3/4".

Door & Drawer Options

AF	CC	CG	GAMD	IFHG	MD	MFO ¹	PRMD	SGLPN	SHMD	SPLITDR ²

End Panel Options

AUTH	CSFPE	EXBK	EXDN	FFD	FL/FR	FPE	INTGE	IPE

Custom Modification Options

ADDTK	ADRW	BVR	CBO	CCO ³	CFNTO	CFP ⁴	CFRMO ¹	CLIP	CND ⁴	CSDGBK	DRWTK	EX	EX_OL	FD	FLUT ⁵	FTK ⁶	ID	IH	INVFRM

IW ⁷	MIP	OBRB	PFINBTMB	RD	RECTK	RECTKFR	RH	ROSLUT ⁸	RT	RW ⁹	STORB	TD ¹⁰	TKP	TVR ¹¹	VTK	WS	WTR

- ¹ Only available on 24" (1 door) wide.
- ² Only available on 24" (2 doors)-36" wide.
- ³ Only available on 24" (1 door and 2 doors) wide.
- ⁴ Not available on 24" (1 door) wide.
- ⁵ Not available with fluting both or 6" fluting.
- ⁶ Only available on FTKAV and style B-L.
- ⁷ Not available on 24" (1 door) or 36" wide.
- ⁸ Not available with fluting both.
- ⁹ Only available on 18" wide.
- ¹⁰ Not available on 24" (2 doors) wide.
- ¹¹ Not available on TVRAV.

IH/RH availability charts starting on page G-40.
IW/RW availability charts starting on page G-46.

TALL BOOKCASE with OFFICE HEIGHT DOORS and ARCHED VALANCE, 90" HIGH

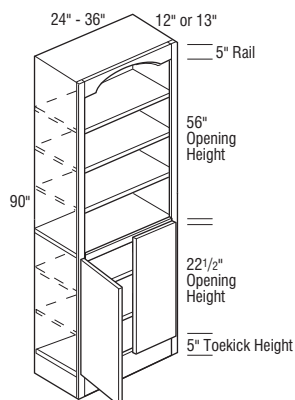
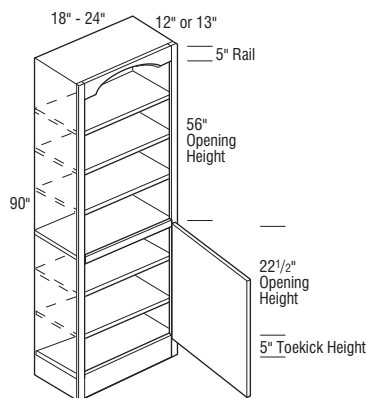

	Cubic Feet	1	2	3	4	5	6	7
TDO189012BCAV L or R	15.0	2615	2742	2837	2993	3171	3464	3757
TDO219012BCAV L or R	17.3	2948	3091	3200	3377	3574	3903	4232
TDO249012BCAV L or R	19.6	3205	3358	3478	3667	3884	4242	4600

TDO249012BCAV	19.6	3397	3563	3688	3886	4117	4496	4875
TDO279012BCAV	21.9	3527	3695	3827	4035	4274	4670	5066
TDO309012BCAV	24.2	3864	4049	4191	4420	4681	5111	5541
TDO339012BCAV	26.5	4196	4399	4553	4803	5088	5555	6022
TDO369012BCAV	28.8	4543	4761	4931	5199	5507	6013	6519

Notes below apply to all products in section above:

- Matching Interior and Flush Toekick standard.
- Five adjustable shelves.
- Straight Valance is standard on Beaded Inset styles.
- Arch Valance is standard; specify Straight, style B, style D, style E, style H, style J, style K, or style L if desired.
- Inset and Beaded Inset styles are a standard 13" deep.
- Full Overlay Styles:
 - Increased Depths available in 1/4" increments from 12 1/4" to 30".
 - Reduced Depths available in 1/4" increments from 6" to 11 3/4".
- Inset and Beaded Inset Styles:
 - Increased Depths available in 1/4" increments from 13 1/4" to 30".
 - Reduced Depths available in 1/4" increments from 6" to 12 3/4".

Door & Drawer Options

AF	CC	CG	GAMD	IFHG	MD	MFO ¹	PRMD	SGLPN	SHMD	SPLITDR ²

End Panel Options

AUTH	CSFPE	EXBK	EXDN	FFD	FL/FR	FPE	INTGE	IPE

Custom Modification Options

ADDTK	ADRW	BVR	CBO	CCO ³	CFNTO	CFP ⁴	CFRMO ¹	CLIP	CND ⁴	CSDGBK	DRWTK	EX	EX_OL	FD	FLUT ⁵	FTK ⁶	ID	IH	INVRM
IW ⁷	MIP	OBRB	PFINBTMB	RD	RECTK	RECTKFRT	RH	ROSEFLUT ⁸	RT	RW ⁹	STORB	TD ¹⁰	TKP	TVR ¹¹	VTK	WS	WTR		

¹ Only available on 24" (1 door) wide.

² Only available on 24" (2 doors)-36" wide.

³ Only available on 24" (1 door and 2 doors) wide.

⁴ Not available on 24" (1 door) wide.

⁵ Not available with fluting both or 6" fluting.

⁶ Only available on FTKAV and style B-L.

⁷ Not available on 24" (1 door) or 36" wide.

⁸ Not available with fluting both.

⁹ Only available on 18" wide.

¹⁰ Not available on 24" (2 doors) wide.

¹¹ Not available on TVRAV.

Bookcases

TALL BOOKCASE with OFFICE HEIGHT DOORS and ARCHED VALANCE, 96" HIGH

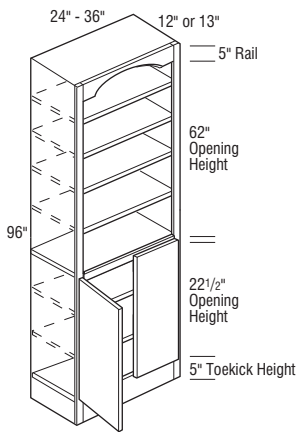
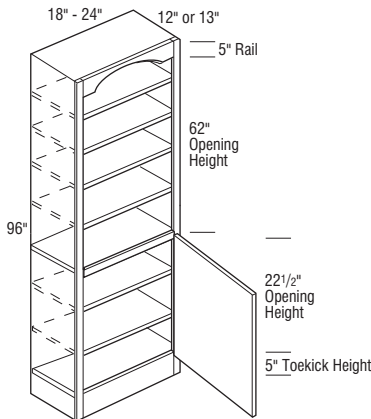

	Cubic Feet	1	2	3	4	5	6	7
TDO189612BCAV L or R	16.0	2781	2914	3018	3181	3371	3681	3991
TDO219612BCAV L or R	18.4	3127	3280	3392	3580	3790	4141	4492
TDO249612BCAV L or R	20.9	3408	3571	3695	3900	4130	4509	4888

TDO249612BCAV	20.9	3378	3537	3665	3865	4093	4468	4843
TDO279612BCAV	23.3	3742	3924	4063	4286	4538	4954	5370
TDO309612BCAV	25.8	4098	4295	4445	4688	4966	5423	5880
TDO339612BCAV	28.2	4447	4664	4828	5092	5394	5889	6384
TDO369612BCAV	30.7	4814	5045	5223	5509	5836	6374	6912

Notes below apply to all products in section above:

- Matching Interior and Flush Toe-kick standard.
- Six adjustable shelves.
- Straight Valance is standard on Beaded Inset styles.
- Arch Valance is standard; specify Straight, style B, style D, style E, style H, style J, style K, or style L if desired.
- Inset and Beaded Inset styles are a standard 13" deep.
- Full Overlay Styles:
 - Increased Depths available in 1/4" increments from 12 1/4" to 30".
 - Reduced Depths available in 1/4" increments from 6" to 11 3/4".
- Inset and Beaded Inset Styles:
 - Increased Depths available in 1/4" increments from 13 1/4" to 30".
 - Reduced Depths available in 1/4" increments from 6" to 12 3/4".

Door & Drawer Options

AF	CC	CG	GAMD	IFHG	MD	MFO ¹	PRMD	SGLPN	SHMD	SPLITDR ²
				✓		✓			✓	✓

End Panel Options

AUTH	CSFPE	EXBK	EXDN	FFD	FL/FR	FPE	INTGE	IPE
✓	✓	✓			✓	✓	✓	✓

Custom Modification Options

ADDTK	ADRW	BVR	CBO	CCO ³	CFNT0	CFP ⁴	CFRMO ¹	CLIP	CND ⁴	CSDGBK	DRWTK	EX	EX_OL	FD	FLUT ⁵	FTK ⁶	ID	IH	INVFRM
			✓	✓	✓	✓	✓	✓	✓	✓	✓	✓	✓	✓	✓	✓	✓	✓	✓

IW ⁷	MIP	OBRB	PFINBTMB	RD	RECTK	RECTKFR	RH	ROSLUT ⁸	RT	RW ⁹	STORB	TD ¹⁰	TKP	TVR ¹¹	VTK	WS	WTR
✓		✓					✓	✓	✓	✓		✓	✓	✓	✓	✓	✓

- ¹ Only available on 24" (1 door) wide.
- ² Only available on 24" (2 doors)-36" wide.
- ³ Only available on 24" (1 door and 2 doors) wide.
- ⁴ Not available on 24" (1 door) wide.
- ⁵ Not available with fluting both or 6" fluting.
- ⁶ Only available on FTKAV and style B-L.
- ⁷ Not available on 24" (1 door) or 36" wide.
- ⁸ Not available with fluting both.
- ⁹ Only available on 18" wide.
- ¹⁰ Not available on 24" (2 doors) wide.
- ¹¹ Not available on TVRAV.

IH/RH availability charts starting on page G-40.
IW/RW availability charts starting on page G-46.









How to Use Your Diamond Edge Price List

Your Diamond Edge price guide contains charts with prices for each cabinetry product, arranged according to an alphabetical code. Use the chart below to determine the price code for your preferred cabinetry style.

Then refer to the various sections of this binder to find the types and sizes of cabinets required. Read across each chart to the column that corresponds to your style's price code to determine the price for each unit.

For example, if you want a vanity cabinet that is 12" wide and 30" high in the Karis Cherry style, you would

- Find the price code for Karis Cherry ("3" in the chart below)
- Refer to the "Vanity Cabinets" section of this binder
- Locate product code W12304 L or R (W = vanity wall, 12 = width in inches, 30 = height in inches)
- Read across the chart in the same row to column 3 to find the price for this model in Karis Cherry

Door Styles	Alder	Cherry	Maple	MDF	Quartersawn Oak	Rustic Alder	Walnut
Brooks	3	5	3		5	3	6
Brooks Beaded Inset	3+15%	5+15%	3+15%		5+15%	3+15%	6+15%
Brooks Inset	3+15%	5+15%	3+15%		5+15%	3+15%	6+15%
Caldera 	3	5	3		5	3	6
Daxton	2	4	2		4	2	6
Daxton Beaded Inset	2+15%	4+15%	2+15%		4+15%	2+15%	6+15%
Daxton Inset	2+15%	4+15%	2+15%		4+15%	2+15%	6+15%
Gunther	1	3	1		3	1	5
Gunther Beaded Inset	1+15%	3+15%	1+15%		3+15%	1+15%	5+15%
Gunther Inset	1+15%	3+15%	1+15%		3+15%	1+15%	5+15%
Karis	1	3	1		3	1	5
Karis Beaded Inset	1+15%	3+15%	1+15%		3+15%	1+15%	5+15%
Karis Inset	1+15%	3+15%	1+15%		3+15%	1+15%	5+15%
Langley	5	6	5		6	5	7
Langley Beaded Inset	5+15%	6+15%	5+15%		6+15%	5+15%	7+15%
Langley Inset	5+15%	6+15%	5+15%		6+15%	5+15%	7+15%
Montgomery 	1	3	1		3	1	5
Montgomery Beaded Inset 	1+15%	3+15%	1+15%		3+15%	1+15%	5+15%
Montgomery Inset 	1+15%	3+15%	1+15%		3+15%	1+15%	5+15%
Shona	1	3	1		3	1	5
Shona Beaded Inset	1+15%	3+15%	1+15%		3+15%	1+15%	5+15%
Shona Inset	1+15%	3+15%	1+15%		3+15%	1+15%	5+15%
Sumner 	3	5	3		5	3	6
Tackett	2	4	2		4	2	6
Tackett Beaded Inset	2+15%	4+15%	2+15%		4+15%	2+15%	6+15%
Tackett Inset	2+15%	4+15%	2+15%		4+15%	2+15%	6+15%
Trystan 	4	6	4	1	6		7
Trystan Beaded Inset 				1+15%			
Trystan Inset 				1+15%			
Vesta	2	4	2		4	2	6
Vesta Beaded Inset	2+15%	4+15%	2+15%		4+15%	2+15%	6+15%
Vesta Inset	2+15%	4+15%	2+15%		4+15%	2+15%	6+15%
Wells 	4	6	4		6	4	7

Diamond Edge Modification Option Descriptions

Your Diamond Edge price guide contains charts with modification option codes for each applicable cabinetry product. Reference the listing below to identify the modification description.

Door & Drawer Options	
Option	Description
CC	Craftsman Door
CG	Cut-for-glass
GAMD	Gallery Mullion Door
HC	Horizon Door
IFHG	Inset Finial Hinges
MC	Mission Door
MD	Mullion Door
MFO	Modified Full Overlay
PRMD	Prairie Mullion Door
SGLPN	Single Panel Tall Door
SHMD	Shaker Mullion Door
SPLITDR	Split Doors
SPLITDRWS	Split Drawers
TCG	Transom w/Top Cut-for-glass and Bottom Center Panel
TCP	Transom w/both sections Center Panels

End Panel Options	
Option	Description
AUTH	Authentic Flush End
CSFPE	Car Siding Flush Panel End
EXBK	End Extended Back
EXDN	Wall End and Back Extended Down
FFD	Face Frame and Door on End
FL/FR	Finished Ends
FPE	Flush Panel End
INTGE	Integral End
IPE	Inset Panel Ends

Custom Modification Options	
Option	Description
ADD_SHLF	Add Shelf
ADDTK	Add Toekick
ADRW	Add Drawer Below Wall Unit
BVR	Bottom Valance Rail
CBO	Cabinet Box Only
CCO	Cabinet Case Only
CFNTO	Cabinet Front Only
CFP	Cabinet False Panel
CFRMO	Cabinet Frame Only
CLIP	Clipped Corner
CMAT	CabMat™
CND	Cabinet No Door
CSDGBK	Car Siding Back
DRWTK	Toekick Drawer
EX	Extended Stile
EX_OL	Extended Stile with Overlay
FD	Full Depth Shelf
FLUT	Fluting
FTK	Flush Toekick
ID	Increased Depth
IH	Increased Height
INVFRM	Inverted Frame
IW	Increased Width
MIP	Matching Interior
OBRB	Open Bottom Rail Base
PFINBTMB	Finished Bottom
RD	Reduced Depth
REC	Recessed Vanity Wall
RECTK	Recessed Toekick
RECTK_6	Recessed Toekick — 6"
RECTKFRT6	Recessed Toekick Front — 6"
RH	Reduced Height
ROSLUT	Rose Fluting
RT	Roll Trays
SBCADDY	Sink Base Cleaning Caddy
SBCADDYSM	Sink Base Cleaning Caddy Small
SCPDRW	Scooped Drawer
TBN	Nickel Towel Bar
TD	Tray Divider
TKP	Toekick Pedestal
TVR	Top Valance Rail
UDBX	U-shaped Drawer Box
URT	U-shaped Roll Tray
VLSO	L-shaped Organizer
VTK	Void Toekick
VWB	Vanity Wastebasket Container
WS	Wide Stiles
WTR	Wide Top Rail

Vanity Wall Cabinets

VANITY WALL, 30" HIGH, 4 5/8" DEEP

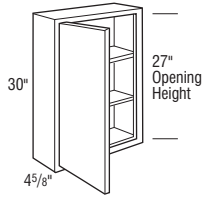

	Cubic Feet	1	2	3	4	5	6	7
W12304 L or R	1.8	745	784	808	854	899	978	1057
W15304 L or R	2.1	768	801	828	876	915	1005	1095
W18304 L or R	2.5	828	871	904	952	1000	1097	1194
W21304 L or R	2.9	869	909	946	996	1055	1143	1231
W24304 L or R	3.3	915	962	999	1051	1108	1207	1306
W24304	3.3	1160	1218	1247	1321	1410	1535	1660
W30304	4.1	1258	1322	1374	1447	1519	1656	1793

Notes below apply to all products in section above:

- Two adjustable shelves.
- Regular doors, not mirrored.

Door & Drawer Options

CC	CG	GAMD	HC	IFHG	MC	MD	MFO	PRMD ¹	SGLPN	SHMD	SPLITDR ²	SPLITDRWS	TCG	TCP
✓	✓	✓	✓	✓	✓	✓	✓	✓	✓	✓	✓	✓	✓	✓

End Panel Options

AUTH	CSFPE	EXBK	EXDN	FFD	FL/FR	FPE	INTGE	IPE
✓	✓	✓	✓	✓	✓	✓	✓	✓

Custom Modification Options

ADD	SHLF	ADDTK	ADRW	BVR ³	CBO	CCO	CFNTO	CFP	CFRMO	CLIP	CMAT	CND	CSDGBK	DRWTK	EX	EX_OL	FD	FLUT ⁴	FTK ⁵	ID	IH	INVRM	IW	
✓	✓	✓	✓	✓	✓	✓	✓	✓	✓	✓	✓	✓	✓	✓	✓	✓	✓	✓	✓	✓	✓	✓	✓	✓
MIP	OBRB ⁶	PFINBTMB ⁷	RD	REC	RECTK	RECTK_6	RECTKFT6	RH	ROSFLOT ⁸	RT	SBCADDY	SBCADDYSM	SCPDRW	TBN	TD	TKP	TVR ⁹	UDBX	URT	VLSO	VTK	VWB	WS	WTR
✓	✓	✓	✓	✓	✓	✓	✓	✓	✓	✓	✓	✓	✓	✓	✓	✓	✓	✓	✓	✓	✓	✓	✓	✓

¹ Not available on 12" or 24" (2 doors) wide.

² Not available on 12"-24" (1 door) wide.

³ Only available on 24" (1 door) wide.

⁴ Fluting both 3" not available on 12" wide. Not available with 6" fluting.

⁵ Not available on 24" (1 door) wide. FTKAV and style B-L also not available on 12" wide.

⁶ Not available on 24" (1 door) wide.

⁷ Only available on 24" (2 doors) wide.

⁸ Fluting both not available on 12" wide.

⁹ TVRAV and style B-L not available on 12" wide.

Vanity Wall Cabinets

VANITY WALL, 36" HIGH, 4 5/8" DEEP

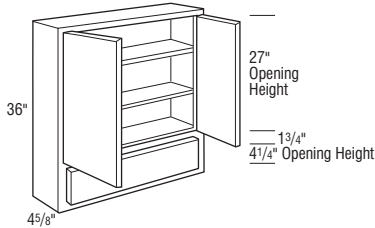
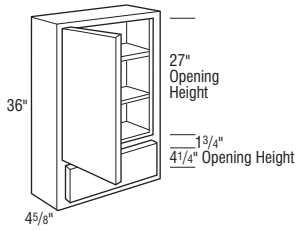

	Cubic Feet	1	2	3	4	5	6	7
W12364 L or R	2.1	878	921	955	1005	1073	1166	1259
W15364 L or R	2.6	918	963	1003	1057	1111	1215	1319
W18364 L or R	3.0	972	1019	1057	1115	1166	1262	1358
W21364 L or R	3.5	1043	1089	1126	1192	1255	1369	1483
W24364 L or R	3.9	1107	1153	1198	1256	1329	1448	1567
W24364	3.9	1399	1464	1506	1583	1701	1854	2007
W30364	4.9	1481	1557	1613	1707	1789	1952	2115
W36364	5.8	1609	1682	1746	1846	1945	2126	2307

Notes below apply to all products in section above:

- One fixed and two adjustable shelves.
- Regular door(s), not mirrored.
- Includes drop front. Daxton, Langley, and DFR5PC incorporate slab front.
- Not available on Inset and Beaded Inset styles.

Door & Drawer Options

CC	CG	GAMD ¹	HC	IFHG ²	MC	MD	MFO	PRMD	SGLPN	SHMD	SPLITDR ³	SPLITDRWS	TCG ⁴	TCP ⁴
✓	✓	✓	✓	✓	✓	✓	✓	✓	✓	✓	✓	✓	✓	✓

End Panel Options

AUTH	CSFPE	EXBK	EXDN	FFD	FL/FR	FPE	INTGE	IPE
✓	✓	✓	✓	✓	✓	✓	✓	✓

Custom Modification Options

ADD	SHLF	ADDTK	ADRW	BVR ⁴	CBO	CCO	CFNTO	CFP	CFRMO	CLIP	CMAT	CND	CSDGBK	DRWTK	EX	EX_OL	FD	FLUT ⁵	FTK ⁶	ID	IH	INVERM	IW	
				✓	✓	✓	✓	✓	✓	✓	✓	✓	✓	✓	✓	✓	✓	✓	✓	✓	✓	✓	✓	✓

MIP	OBRB ⁷	PFINBTMB ⁸	RD	REC	RECTK	RECTK_6	RECTKFR ⁶	RH	ROSLUT ⁹	RT	SBCADDY	SBCADDYSM	SCPDWR	TBN	TD	TKP	TVR ¹⁰	UBX	URT	VLSO	VTK	VWB	WS	WTR
✓	✓	✓	✓	✓	✓	✓	✓	✓	✓	✓	✓	✓	✓	✓	✓	✓	✓	✓	✓	✓	✓	✓	✓	✓

- ¹ Not available on 12" or 24" (2 doors) wide.
- ² Not available on 24" (2 doors) wide.
- ³ Not available on 12"-24" (1 door) wide.
- ⁴ Only available on 24" (1 door) wide.
- ⁵ Fluting both 3" not available on 12" wide. Not available with 6" fluting.
- ⁶ Not available on 24" (1 door) wide. FTKAV and style B-L also not available on 12" wide.
- ⁷ Not available on 24" (1 door) wide.
- ⁸ Only available on 24" (2 doors) wide.
- ⁹ Fluting both not available on 12" wide.
- ¹⁰ TVRAV and style B-L not available on 12" wide.

VANITY RECESSED CABINET, 24" HIGH, 4 5/8" DEEP

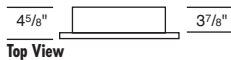
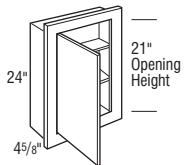

VWR1524 L or R	1.7	768	801	828	876	915	1005	1095
-----------------------	-----	-----	-----	-----	-----	-----	------	------

- Two adjustable shelves.
- Regular door, not mirrored.
- To recess use opening 1" less than overall dimension.
- Cut-out size is 14" W x 22 1/2" H x 4" D.

Door & Drawer Options

CC	CG	GAMD	HC	IFHG	MC	MD	MFO	PRMD	SGLPN	SHMD	SPLITDR	SPLITDRWS	TCG	TCP
✓	✓	✓	✓	✓	✓	✓	✓	✓	✓	✓	✓	✓	✓	✓

End Panel Options

AUTH	CSFPE	EXBK ¹	EXDN	FFD	FL/FR	FPE	INTGE	IPE
		✓						

Custom Modification Options

ADD	SHLF	ADDTK	ADRW	BVR	CBO	CCO	CFNTO	CFP	CFRMO	CLIP	CMAT	CND	CSDGBK	DRWTK	EX	EX_OL	FD	FLUT ²	FTK	ID	IH	INVERM	IW
				✓	✓	✓	✓	✓	✓	✓	✓	✓	✓	✓	✓	✓	✓	✓	✓	✓	✓	✓	✓

MIP	OBRB	PFINBTMB	RD	REC	RECTK	RECTK_6	RECTKFR ⁶	RH	ROSLUT	RT	SBCADDY	SBCADDYSM	SCPDWR	TBN	TD	TKP	TVR	UBX	URT	VLSO	VTK	VWB	WS	WTR
✓	✓	✓	✓	✓	✓	✓	✓	✓	✓	✓	✓	✓	✓	✓	✓	✓	✓	✓	✓	✓	✓	✓	✓	✓

- ¹ Not available on end extended back left.
- ² Not available with 6" fluting.

IH/RH availability charts starting on page G•40.
IW/RW availability charts starting on page G•46.

VANITY WALL RECESSED CABINET, 36" HIGH, 4 5/8" DEEP

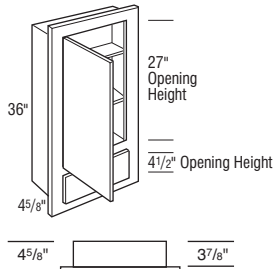

Top View

VWR1536 L or R

Cubic Feet	1	2	3	4	5	6	7
2.6	1011	1059	1105	1166	1207	1324	1441

- To recess use opening 1 1/2" less than overall dimension.
- One fixed and two adjustable shelves.
- Cut-out size is 13 1/2" W x 34 1/2" H x 4" D.
- Regular door, not mirrored.
- Includes drop front.
- Not available on Inset and Beaded Inset styles.

Door & Drawer Options

CC	CG	GAMD	HC	IFHG	MC	MD	MFO	PRMD	SGLPN	SHMD	SPLITDR	SPLITDRWS	TCG	TCP
✓	✓	✓				✓		✓		✓				

End Panel Options

AUTH	CSFPE	EXBK ¹	EXDN	FFD	FL/FR	FPE	INTGE	IPE
		✓						

Custom Modification Options

ADD_SHLF	ADTK	ADRW	BVR	CBO	CCO	CFNTO	CFP	CFRMO	CLIP	CMAT	CND	CSDGBK	DRWTK	EX	EX_OL	FD	FLUT ²	FTK	ID	IH	INVFRM	IW	
				✓	✓	✓		✓			✓	✓					✓	✓					

MIP	OBRB	PFINBTMB	RD	REC	RECTK	RECTK_6	RECTKFR6	RH	ROSFLUT	RT	SBCADDY	SBCADDYSM	SCPDRW	TBN	TD	TKP	TVR	UDBX	URT	VLSO	VTK	VWB	WS	WTR
✓									✓									✓					✓	✓

¹ Not available on end extended back left.

² Not available with 6" fluting.

VANITY MIRROR, 35" HIGH, 21", 27", or 33" WIDE

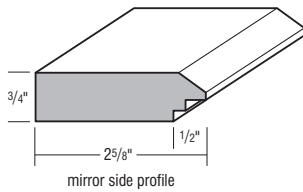
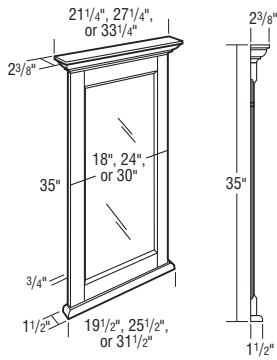

mirror side profile

VM2135	2.2	1010	1010	1010	1010	1010	1010
VM2735	2.7	1098	1098	1098	1098	1098	1098
VM3335	3.3	1192	1192	1192	1192	1192	1192

- Installed mirror has beveled edge.
- Includes two installed metal hanging hooks on back.
- Only available in Cherry and Maple

	Overall Dimensions		Mirror - Visible Dimensions	
	Width	Height	Width	Height
VM2135	21 1/4"	35"	12 15/16"	26 15/16"
VM2735	27 1/4"	35"	18 15/16"	26 15/16"
VM3335	33 1/4"	35"	24 15/16"	26 15/16"

Modifications
Are Not
Available

Vanity Wall Cabinets

WATER CLOSET, 36" HIGH, 9" DEEP

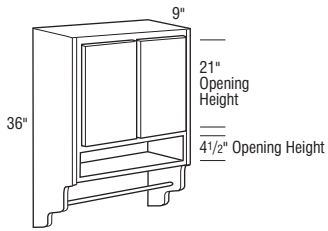

Cubic Feet	1	2	3	4	5	6	7	
WCT24	6.4	1794	1876	1945	2051	2170	2373	2576
WCT27	7.1	1848	1936	2004	2116	2212	2422	2632

- Finished Ends and Matching Interior standard.
- Open shelf standard.
- One fixed and two adjustable shelves.
- Regular doors, not mirrored.

Door & Drawer Options

CC	CG	GAMD	HC	IFHG	MC	MD	MFO	PRMD	SGLPN	SHMD	SPLITDR	SPLITDRWS	TCG	TCP
✓	✓		✓		✓					✓				

End Panel Options

AUTH	CSFPE	EXBK ¹	EXDN	FFD	FL/FR	FPE	INTGE	IPE
		✓						

Custom Modification Options

ADD_SHLF	ADDTK	ADRW	BVR	CBO	CCO	CFNTO	CFP	CFRMO	CLIP	CMAT	CND	CSDGBK	DRWTK	EX	EX_OL	FD	FLUT	FTK	ID	IH	INVRM	IW	
											✓	✓											

MIP	OBRB	PFINBTMB	RD	REC	RECTK	RECTK_6	RECTKFRT6	RH	ROSFLUT	RT	SBCADDY	SBCADDYSM	SCPDRW	TBN	TD	TKP	TVR	UBBX	URT	VLSO	VTK	VWB	WS	WTR
																		✓						✓

¹ Not available on end extended back left.

IH/RH availability charts starting on page G•40.
IW/RW availability charts starting on page G•46.

Vanity Base Cabinets

VANITY BASE, SINGLE DOOR with DRAWER, 32" or 34 1/2" HIGH, 18" or 21" DEEP

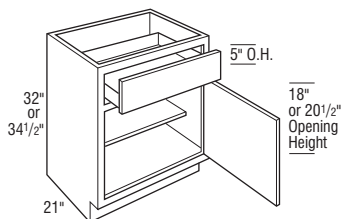
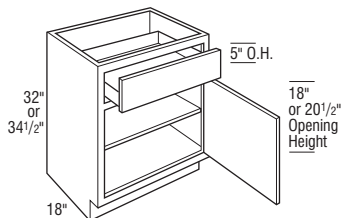

	Cubic Feet	1	2	3	4	5	6	7
VB123218 L or R	5.1	1059	1110	1149	1210	1278	1396	1514
VB153218 L or R	6.2	1108	1161	1206	1278	1324	1450	1576
VB183218 L or R	7.4	1160	1215	1255	1329	1401	1536	1671
VB213218 L or R	8.5	1199	1254	1299	1367	1441	1568	1695
VB243218 L or R	9.7	1236	1299	1346	1417	1485	1624	1763
VB123221 L or R	6.2	1059	1110	1149	1210	1278	1396	1514
VB153221 L or R	7.5	1108	1161	1206	1278	1324	1450	1576
VB183221 L or R	8.9	1160	1215	1255	1329	1401	1536	1671
VB213221 L or R	10.3	1199	1254	1299	1367	1441	1568	1695
VB243221 L or R	11.6	1236	1299	1346	1417	1485	1624	1763
VB123418 L or R	5.4	1108	1161	1203	1265	1337	1458	1579
VB153418 L or R	6.7	1160	1213	1261	1337	1388	1516	1644
VB183418 L or R	7.9	1212	1272	1313	1390	1466	1608	1750
VB213418 L or R	9.2	1252	1311	1358	1429	1506	1641	1776
VB243418 L or R	10.4	1293	1358	1404	1481	1555	1699	1843
VB123421 L or R	6.6	1108	1161	1203	1265	1337	1458	1579
VB153421 L or R	8.1	1160	1213	1261	1337	1388	1516	1644
VB183421 L or R	9.5	1212	1272	1313	1390	1466	1608	1750
VB213421 L or R	11.0	1252	1311	1358	1429	1506	1641	1776
VB243421 L or R	12.5	1293	1358	1404	1481	1555	1699	1843

- 18" deep includes one adjustable Full Depth Shelf.
- 21" deep includes one adjustable 15" deep shelf.
- Increased Depths available in 1/4" increments from 21 1/4" to 24".
- Reduced Depths available in 1/4" increments from 12" to 20 3/4".

Door & Drawer Options

CC	CG	GAMD	HC	IFHG	MC	MD	MFO	PRMD ¹	SGLPN	SHMD	SPLITDR	SPLITDRWS	TCG	TCP
✓	✓	✓	✓	✓	✓	✓	✓	✓	✓	✓	✓	✓	✓	✓

End Panel Options

AUTH	CSFPE	EXBK	EXDN	FFD	FL/FR	FPE	INTGE	IPE
✓	✓	✓	✓	✓	✓	✓	✓	✓

Custom Modification Options

ADD	SHLF	ADDTK	ADRW	BVR	CBO	CCO	CFNT0	CFP	CFRMO	CLIP ²	CMAT	CND	CSDGBK	DRWTK ³	EX	EX_OL	FD ⁴	FLUT ⁵	FTK ⁶	ID	IH	INVRM	IW	
✓	✓	✓	✓	✓	✓	✓	✓	✓	✓	✓	✓	✓	✓	✓	✓	✓	✓	✓	✓	✓	✓	✓	✓	✓

MIP	OBRB	PFINBTMB	RD	REC	RECTK	RECTK_6 ⁷	RECTKRT6	RH	ROSFLUT	RT	SBCADDY	SBCADDYSM ¹	SCPDRW	TBN	TD	TKP	TVR ⁸	UDBX ³	URT ³	VLSO	VTK	VWB	WS	WTR
✓	✓	✓	✓	✓	✓	✓	✓	✓	✓	✓	✓	✓	✓	✓	✓	✓	✓	✓	✓	✓	✓	✓	✓	✓

¹ Not available on 12" wide.

² Not available on 12" wide.

³ Only available on 24" wide.

⁴ Not available on 18" deep.

⁵ 6" fluting not available on 12" or 15" wide. Fluting both 6" not available.

⁶ FTKAV and style B-L not available on 12" wide.

⁷ 12" wide can only be recessed in front and/or back. 15" and 18" wide can only be recessed in the front, back, and/or one side only. 18" deep can not be recessed in both the front and back.

⁸ TVRAV and style B-L not available on 12" wide.

Vanity Base Cabinets

VANITY BASE, DOUBLE DOOR with DRAWER, 32" or 34 1/2" HIGH, 18" or 21" DEEP

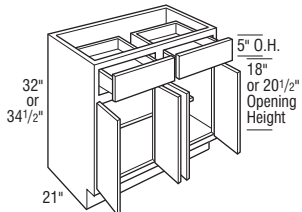
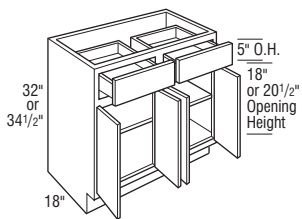
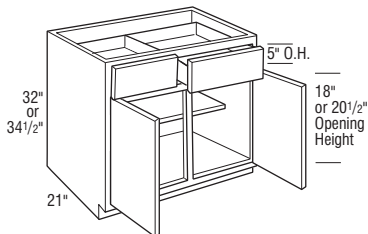
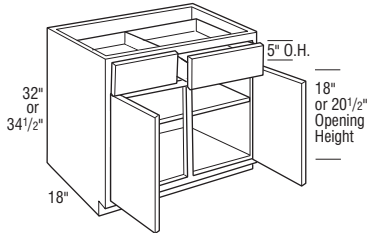
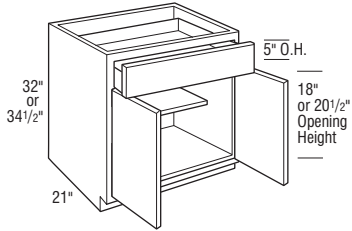
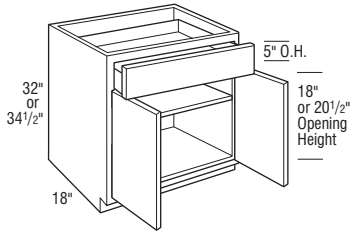

	Cubic Feet	1	2	3	4	5	6	7
VB243218	9.7	1568	1646	1700	1795	1888	2063	2238
VB273218	10.9	1721	1806	1872	1977	2075	2272	2469
VB303218	12.0	1778	1864	1929	2035	2137	2332	2527
VB333218	13.2	1810	1899	1976	2078	2188	2394	2600
VB363218	14.3	1872	1960	2035	2149	2254	2464	2674
VB393218	15.5	1922	2014	2088	2206	2320	2530	2740
VB243221	11.6	1568	1646	1700	1795	1888	2063	2238
VB273221	13.0	1721	1806	1872	1977	2075	2272	2469
VB303221	14.4	1778	1864	1929	2035	2137	2332	2527
VB333221	15.7	1810	1899	1976	2078	2188	2394	2600
VB363221	17.1	1872	1960	2035	2149	2254	2464	2674
VB393221	18.5	1922	2014	2088	2206	2320	2530	2740
VB243418	10.4	1641	1721	1776	1876	1976	2158	2340
VB273418	11.7	1802	1888	1958	2067	2172	2377	2582
VB303418	12.9	1859	1949	2017	2127	2238	2444	2650
VB333418	14.2	1893	1987	2064	2175	2289	2507	2725
VB363418	15.4	1958	2051	2127	2246	2361	2576	2791
VB393418	16.6	2013	2107	2185	2307	2423	2649	2875
VB243421	12.5	1641	1721	1776	1876	1976	2158	2340
VB273421	14.0	1802	1888	1958	2067	2172	2377	2582
VB303421	15.4	1859	1949	2017	2127	2238	2444	2650
VB333421	16.9	1893	1987	2064	2175	2289	2507	2725
VB363421	18.4	1958	2051	2127	2246	2361	2576	2791
VB393421	19.8	2013	2107	2185	2307	2423	2649	2875
VB423218	16.6	1973	2064	2139	2257	2384	2599	2814
VB453218	17.8	2152	2248	2327	2444	2572	2789	3006
VB483218CS	19.0	2156	2254	2334	2467	2603	2850	3097
VB423221	19.8	1973	2064	2139	2257	2384	2599	2814
VB453221	21.2	2152	2248	2327	2444	2572	2789	3006
VB483221CS	22.6	2156	2254	2334	2467	2603	2850	3097
VB423418	17.9	2061	2159	2240	2363	2491	2717	2943
VB453418	19.1	2250	2352	2436	2556	2689	2913	3137
VB483418CS	20.4	2254	2361	2447	2577	2721	2978	3235
VB423421	21.3	2061	2159	2240	2363	2491	2717	2943
VB453421	22.8	2250	2352	2436	2556	2689	2913	3137
VB483421CS	24.2	2254	2361	2447	2577	2721	2978	3235
VB483218	19.0	2264	2367	2451	2590	2733	2993	3253
VB483221	21.8	2264	2367	2451	2590	2733	2993	3253
VB483418	20.4	2367	2479	2569	2706	2857	3127	3397
VB483421	23.4	2367	2479	2569	2706	2857	3127	3397

- 18" deep includes one adjustable Full Depth Shelf.
- 21" deep includes one adjustable 15" deep shelf.
- Increased Depths available in 1/4" increments from 21 1/4" to 24".
- Reduced Depths available in 1/4" increments from 12" to 20 3/4".

Door & Drawer Options

CC	CG	GAMD	HC	IFHG	MC	MD	MFO	PRMD	SGLPN	SHMD	SPLITDR ¹	SPLITDRWS ²	TCG	TCP
<input checked="" type="checkbox"/>	<input checked="" type="checkbox"/>	<input checked="" type="checkbox"/>	<input checked="" type="checkbox"/>	<input checked="" type="checkbox"/>	<input checked="" type="checkbox"/>	<input checked="" type="checkbox"/>	<input checked="" type="checkbox"/>	<input checked="" type="checkbox"/>	<input checked="" type="checkbox"/>	<input checked="" type="checkbox"/>	<input checked="" type="checkbox"/>	<input checked="" type="checkbox"/>	<input checked="" type="checkbox"/>	<input checked="" type="checkbox"/>

End Panel Options

AUTH	CSFPE	EXBK	EXDN	FFD	FL/FR	FPE	INTGE	IPE
<input checked="" type="checkbox"/>	<input checked="" type="checkbox"/>	<input checked="" type="checkbox"/>	<input checked="" type="checkbox"/>	<input checked="" type="checkbox"/>	<input checked="" type="checkbox"/>	<input checked="" type="checkbox"/>	<input checked="" type="checkbox"/>	<input checked="" type="checkbox"/>

Custom Modification Options

ADD_SHLF	ADTK	ADRW	BVR	CBO	CCO	CFNTO	CFP ¹	CFRMO	CLIP	CMAT	CND	CSDGBK	DRWTK ³	EX	EX_OL	FD ⁴	FLUT ⁵	FTK	ID	IH	INVFRM	IW ⁶
<input checked="" type="checkbox"/>	<input checked="" type="checkbox"/>	<input checked="" type="checkbox"/>	<input checked="" type="checkbox"/>	<input checked="" type="checkbox"/>	<input checked="" type="checkbox"/>	<input checked="" type="checkbox"/>	<input checked="" type="checkbox"/>	<input checked="" type="checkbox"/>	<input checked="" type="checkbox"/>	<input checked="" type="checkbox"/>	<input checked="" type="checkbox"/>	<input checked="" type="checkbox"/>	<input checked="" type="checkbox"/>	<input checked="" type="checkbox"/>	<input checked="" type="checkbox"/>	<input checked="" type="checkbox"/>	<input checked="" type="checkbox"/>	<input checked="" type="checkbox"/>	<input checked="" type="checkbox"/>	<input checked="" type="checkbox"/>	<input checked="" type="checkbox"/>	<input checked="" type="checkbox"/>

MIP	ORRB	PFINBTMB	RD	REC	RECTK	RECTK_6 ⁷	RECTKRT6	RH	ROSLUT	RT	SBCADDY ⁸	SBCADDYSM ⁹	SCPDWR	TBN	TD	TKP	TVR ¹	UDBX ⁹	URT ⁵	VLISO	VTK	VWB	WS	WTR
<input checked="" type="checkbox"/>	<input checked="" type="checkbox"/>	<input checked="" type="checkbox"/>	<input checked="" type="checkbox"/>	<input checked="" type="checkbox"/>	<input checked="" type="checkbox"/>	<input checked="" type="checkbox"/>	<input checked="" type="checkbox"/>	<input checked="" type="checkbox"/>	<input checked="" type="checkbox"/>	<input checked="" type="checkbox"/>	<input checked="" type="checkbox"/>	<input checked="" type="checkbox"/>	<input checked="" type="checkbox"/>	<input checked="" type="checkbox"/>	<input checked="" type="checkbox"/>	<input checked="" type="checkbox"/>	<input checked="" type="checkbox"/>	<input checked="" type="checkbox"/>	<input checked="" type="checkbox"/>	<input checked="" type="checkbox"/>	<input checked="" type="checkbox"/>	<input checked="" type="checkbox"/>	<input checked="" type="checkbox"/>	<input checked="" type="checkbox"/>

- 1 Not available on 42"-48" wide.
- 2 Not available on 24" or 48" wide.
- 3 Not available on 39"-48" wide.
- 4 Not available on 18" deep.
- 5 6" fluting not available on 24" wide.
- 6 Not available on 36" or 48" wide.
- 7 18" deep can not be recessed in both the front and back.
- 8 Not available on 24" wide.
- 9 Not available on 42" or 45" wide.

IH/RH availability charts starting on page G-40.
IW/RW availability charts starting on page G-46.

VANITY BASE SINGLE DOOR with SHELF, 32" or 34 1/2" HIGH, 21" DEEP

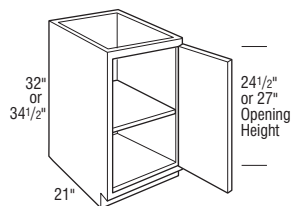

	Cubic Feet	1	2	3	4	5	6	7
V123221S L or R	6.2	1059	1110	1149	1210	1278	1396	1514
V153221S L or R	7.5	1108	1161	1206	1278	1324	1450	1576
V183221S L or R	8.9	1160	1215	1255	1329	1401	1536	1671
V213221S L or R	10.3	1199	1254	1299	1367	1441	1568	1695
V243221S L or R	11.6	1236	1299	1346	1417	1485	1624	1763
V123421S L or R	6.6	1108	1161	1203	1265	1337	1458	1579
V153421S L or R	8.1	1160	1213	1261	1337	1388	1516	1644
V183421S L or R	9.5	1212	1272	1313	1390	1466	1608	1750
V213421S L or R	11.0	1252	1311	1358	1429	1506	1641	1776
V243421S L or R	12.5	1293	1358	1404	1481	1555	1699	1843

- Adjustable Full Depth Shelf.
- Increased Depths available in 1/4" increments from 21 1/4" to 24".
- Reduced Depths available in 1/4" increments from 12" to 20 3/4".

Door & Drawer Options

CC	CG	GAMD	HC	IFHG	MC	MD	MFO	PRMD ¹	SGLPN	SHMD	SPLITDR	SPLITDRWS	TCG	TCP
✓	✓	✓	✓	✓	✓	✓	✓	✓	✓	✓	✓	✓	✓	✓

End Panel Options

AUTH	CSFPE	EXBK	EXDN	FFD	FL/FR	FPE	INTGE	IPE
✓	✓	✓	✓	✓	✓	✓	✓	✓

Custom Modification Options

ADD_SHLF	ADDTK	ADRW	BVR	CBO	CCO	CFNTO	CFP	CFRMO	CLIP ²	CMAT	CND	CSDGBK	DRWTK	EX	EX_OL	FD	FLUT ³	FTK ⁴	ID	IH	INVFRM	IW	
✓	✓	✓	✓	✓	✓	✓	✓	✓	✓	✓	✓	✓	✓	✓	✓	✓	✓	✓	✓	✓	✓	✓	✓

MIP	OBRB	PFINBTMB	RD	REC	RECTK	RECTK_6 ⁵	RECTKFRT6	RH	ROSFLUT	RT	SBCADDY	SBCADDYSM ¹	SCPDRW	TBN	TD	TKP	TVR ⁶	UDBX	URT ⁷	VLSO	VTK	VWB	WS	WTR
✓	✓	✓	✓	✓	✓	✓	✓	✓	✓	✓	✓	✓	✓	✓	✓	✓	✓	✓	✓	✓	✓	✓	✓	✓

¹ Not available on 12" wide.

² Not available on 12" wide.

³ 6" fluting not available on 12" or 15" wide. Fluting both 6" not available.

⁴ FTKAV and style B-L not available on 12" wide.

⁵ 12" wide can only be recessed in front and/or back. 15" and 18" wide can only be recessed in the front, back, and/or one side only.

⁶ TVRAV and style B-L not available on 12" wide.

⁷ Only available on 24" wide.

Vanity Base Cabinets

VANITY BASE with SHELF, 32" or 34 1/2" HIGH, 21" DEEP

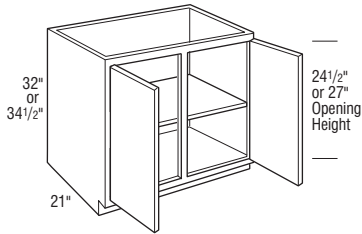
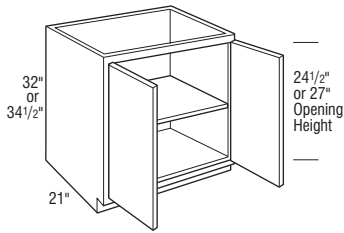

	Cubic Feet	1	2	3	4	5	6	7
V243221S	11.6	1567	1645	1688	1784	1886	2059	2232
V273221S	13.0	1710	1795	1856	1952	2068	2265	2462
V303221S	14.4	1770	1856	1919	2026	2127	2327	2527
V333221S	15.7	1810	1899	1976	2078	2188	2394	2600
V363221S	17.1	1864	1952	2017	2128	2246	2462	2678
V393221S	18.5	1914	2003	2068	2185	2310	2524	2738
V243421S	12.5	1640	1720	1769	1864	1973	2154	2335
V273421S	14.0	1786	1876	1944	2043	2163	2367	2571
V303421S	15.4	1851	1944	2009	2118	2224	2436	2648
V333421S	16.9	1893	1987	2064	2175	2289	2507	2725
V363421S	18.4	1949	2043	2110	2225	2351	2575	2799
V393421S	19.8	2000	2096	2163	2282	2416	2644	2872
V423221S	19.8	1956	2052	2122	2239	2369	2585	2801
V453221S	21.2	2052	2155	2225	2348	2476	2709	2942
V483221S	22.6	2145	2250	2329	2457	2591	2831	3071
V423421S	21.3	2047	2145	2218	2337	2475	2708	2941
V453421S	22.8	2145	2252	2327	2454	2590	2831	3072
V483421S	24.2	2243	2357	2437	2571	2711	2962	3213

- Adjustable Full Depth Shelf.
- Increased Depths available in 1/4" increments from 21 1/4" to 24".
- Reduced Depths available in 1/4" increments from 12" to 20 3/4".

Door & Drawer Options

CC	CG	GAMD	HC	IFHG	MC	MD	MFO	PRMD	SGLPN	SHMD	SPLITDR ¹	SPLITDRWS	TCG	TCP
✓	✓	✓	✓	✓	✓	✓	✓	✓	✓	✓	✓	✓	✓	✓

End Panel Options

AUTH	CSFPE	EXBK	EXDN	FFD	FL/FR	FPE	INTGE	IPE
✓	✓	✓	✓	✓	✓	✓	✓	✓

Custom Modification Options

ADD_SHLF	ADDTK	ADRW	BVR	CBO	CCO	CFNTO	CFP	CFRMO	CLIP	CMAT	CND	CSDGBK	DRWTK	EX	EX_OL	FD	FLUT ²	FTK	ID	IH	INVFRM	IW ³		
✓	✓	✓	✓	✓	✓	✓	✓	✓	✓	✓	✓	✓	✓	✓	✓	✓	✓	✓	✓	✓	✓	✓	✓	
MIP	OBRB	PFINBTMB	RD	REC	RECTK	RECTK_6	RECTKFRT6	RH	ROSFLUT	RT	SBCADDY ⁴	SBCADDYSM ⁴	SCPDWR	TBN	TD	TKP	TVR ¹	UDBX	URT ⁵	VLSO	VTK	VWB	WS	WTR
✓	✓	✓	✓	✓	✓	✓	✓	✓	✓	✓	✓	✓	✓	✓	✓	✓	✓	✓	✓	✓	✓	✓	✓	✓

¹ Not available on 42"-48" wide.

² 6" fluting not available on 24" wide.

³ Not available on 36" or 48" wide.

⁴ Not available on 24" wide.

⁵ Not available on 39"-48" wide.

IH/RH availability charts starting on page G•40.
IW/RW availability charts starting on page G•46.

VANITY BASE SINGLE DOOR without SHELF, 32" or 34 1/2" HIGH, 18" or 21" DEEP

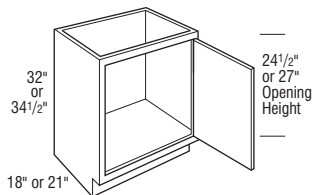

	Cubic Feet	1	2	3	4	5	6	7
V123218 L or R	5.1	1059	1110	1149	1210	1278	1396	1514
V153218 L or R	6.2	1108	1161	1206	1278	1324	1450	1576
V183218 L or R	7.4	1160	1215	1255	1329	1401	1536	1671
V213218 L or R	8.5	1199	1254	1299	1367	1441	1568	1695
V243218 L or R	9.7	1236	1299	1346	1417	1485	1624	1763
V123221 L or R	6.2	1059	1110	1149	1210	1278	1396	1514
V153221 L or R	7.5	1108	1161	1206	1278	1324	1450	1576
V183221 L or R	8.9	1160	1215	1255	1329	1401	1536	1671
V213221 L or R	10.3	1199	1254	1299	1367	1441	1568	1695
V243221 L or R	11.6	1236	1299	1346	1417	1485	1624	1763
V123418 L or R	5.4	1108	1161	1203	1265	1337	1458	1579
V153418 L or R	6.7	1160	1213	1261	1337	1388	1516	1644
V183418 L or R	7.9	1212	1272	1313	1390	1466	1608	1750
V213418 L or R	9.2	1252	1311	1358	1429	1506	1641	1776
V243418 L or R	10.4	1293	1358	1404	1481	1555	1699	1843
V123421 L or R	6.6	1108	1161	1203	1265	1337	1458	1579
V153421 L or R	8.1	1160	1213	1261	1337	1388	1516	1644
V183421 L or R	9.5	1212	1272	1313	1390	1466	1608	1750
V213421 L or R	11.0	1252	1311	1358	1429	1506	1641	1776
V243421 L or R	12.5	1293	1358	1404	1481	1555	1699	1843

- Increased Depths available in 1/4" increments from 21 1/4" to 24".
- Reduced Depths available in 1/4" increments from 12" to 20 3/4".

Door & Drawer Options

CC	CG	GAMD	HC	IFHG	MC	MD ¹	MFO	PRMD ¹	SGLPN	SHMD	SPLITDR	SPLITDRWS	TCG	TCP
✓				✓		✓		✓						

End Panel Options

AUTH	CSFPE	EXBK	EXDN	FFD	FL/FR	FPE	INTGE	IPE
✓	✓	✓	✓	✓	✓	✓	✓	✓

Custom Modification Options

ADD_SHLF	ADDTK	ADRW	BVR	CBO	CCO	CFNTO	CFP	CFRMO	CLIP ¹	CMAT	CND	CSDGBK	DRWTK	EX	EX_OL	FD	FLUT ²	FTK ³	ID	IH	INVFRM	IW ⁴	
				✓	✓	✓		✓	✓	✓	✓	✓	✓	✓	✓	✓	✓	✓	✓	✓	✓	✓	✓

MIP	OBRB	PFINBTMB	RD	REC	RECTK	RECTK_6 ⁵	RECTKFR16	RH	ROSFLUT ⁶	RT	SBCADDY ⁷	SBCADDYSM ⁷	SCPDWR	TBN	TD	TKP	TVR ⁸	UDBX	URT ⁹	VLSO	VTK	VWB	WS ¹⁰	WTR
✓	✓		✓	✓	✓	✓	✓		✓	✓	✓	✓	✓			✓	✓	✓	✓	✓	✓	✓	✓	✓

- ¹ Not available on 12" wide.
- ² 6" fluting not available on 12" or 15" wide and FLUT6B not available.
- ³ FTKAV and style B-L not available on 12" wide.
- ⁴ Not available on 24" wide.
- ⁵ 12" wide can only be recessed in front and/or back. 15" and 18" wide can only be recessed in the front, back, and/or one side only. 18" deep can not be recessed in both the front and back.
- ⁶ ROSFLUT3B not available on 12" or 15" wide.
- ⁷ Not available on depths less than 21" and SBCADDY also not available on 12" wide.
- ⁸ TVRAV and style B-L not available on 12" wide.
- ⁹ Not available on 18" deep and only available on 24" wide.
- ¹⁰ WS83 not available on 12" wide.

Vanity Base Cabinets

VANITY BASE without SHELF, 32" or 34 1/2" HIGH, 18" or 21" DEEP

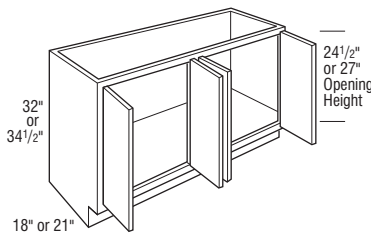
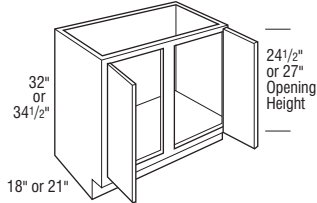
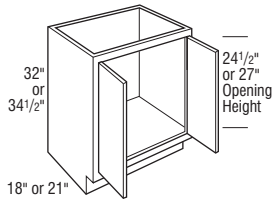

	Cubic Feet	1	2	3	4	5	6	7
V243218	9.7	1567	1645	1688	1784	1886	2059	2232
V273218	10.9	1710	1795	1856	1952	2068	2265	2462
V303218	12.0	1770	1856	1919	2026	2127	2327	2527
V333218	13.2	1810	1899	1976	2078	2188	2394	2600
V363218	14.3	1864	1952	2017	2128	2246	2462	2678
V393218	15.5	1914	2003	2068	2185	2310	2524	2738
V243221	11.6	1567	1645	1688	1784	1886	2059	2232
V273221	13.0	1710	1795	1856	1952	2068	2265	2462
V303221	14.4	1770	1856	1919	2026	2127	2327	2527
V333221	15.7	1810	1899	1976	2078	2188	2394	2600
V363221	17.1	1864	1952	2017	2128	2246	2462	2678
V393221	18.5	1914	2003	2068	2185	2310	2524	2738
V243418	10.4	1640	1720	1769	1864	1973	2154	2335
V273418	11.7	1786	1876	1944	2043	2163	2367	2571
V303418	12.9	1851	1944	2009	2118	2224	2436	2648
V333418	14.2	1893	1987	2064	2175	2289	2507	2725
V363418	15.4	1949	2043	2110	2225	2351	2575	2799
V393418	16.6	2000	2096	2163	2282	2416	2644	2872
V243421	12.5	1640	1720	1769	1864	1973	2154	2335
V273421	14.0	1786	1876	1944	2043	2163	2367	2571
V303421	15.4	1851	1944	2009	2118	2224	2436	2648
V333421	16.9	1893	1987	2064	2175	2289	2507	2725
V363421	18.4	1949	2043	2110	2225	2351	2575	2799
V393421	19.8	2000	2096	2163	2282	2416	2644	2872

V423218	16.6	1956	2052	2122	2239	2369	2585	2801
V453218	17.8	2052	2155	2225	2348	2476	2709	2942
V483218CS	19.0	2145	2250	2329	2457	2591	2831	3071
V423221	19.8	1956	2052	2122	2239	2369	2585	2801
V453221	21.2	2052	2155	2225	2348	2476	2709	2942
V483221CS	22.6	2145	2250	2329	2457	2591	2831	3071
V423418	17.9	2047	2145	2218	2337	2475	2708	2941
V453418	19.1	2145	2252	2327	2454	2590	2831	3072
V483418CS	20.4	2243	2357	2437	2571	2711	2962	3213
V423421	21.3	2047	2145	2218	2337	2475	2708	2941
V453421	22.8	2145	2252	2327	2454	2590	2831	3072
V483421CS	24.2	2243	2357	2437	2571	2711	2962	3213

V483218	19.0	2252	2363	2445	2580	2721	2973	3225
V483221	22.6	2360	2475	2562	2703	2850	3114	3378
V483418	20.4	2355	2475	2559	2700	2847	3110	3373
V483421	24.2	2310	2428	2510	2648	2792	3051	3310

- Increased Depths available in 1/4" increments from 21 1/4" to 24".
- Reduced Depths available in 1/4" increments from 12" to 20 3/4".

Door & Drawer Options

CC	CG	GAMD	HC	IFHG	MC	MD	MFO	PRMD	SGLPN	SHMD	SPLITDR ¹	SPLITDRWS	TCG	TCP
✓	✓			✓		✓		✓			✓			

End Panel Options

AUTH	CSFPE	EXBK	EXDN	FFD	FL/FR	FPE	INTGE	IPE
✓	✓	✓	✓	✓	✓	✓	✓	✓

Custom Modification Options

ADD	SHLF	ADTK	ADRW	BVR	CBO	CCO	CFNTD	CFP	CFRMO	CLIP	CMAT	CND	CSDGBK	DRWK ²	EX	EX_OL	FD	FLUT ³	FTK	ID	IH	INFRM	IW ⁴	
										✓	✓	✓	✓	✓	✓	✓	✓	✓	✓	✓	✓	✓	✓	✓

MIP	OBRR	PFINBTMB	RD	REC	RECTK	RECTK ⁵	RECTKRT ⁶	RH	ROSFLUT	RT	SBCADDY ⁶	SBCADDYSM ⁶	SCDRW	TBN	TD	TKP	TVR ¹	UDBX	URT ⁷	VLSO	VTK	VWB	WS ⁸	WTR
✓	✓			✓	✓	✓	✓	✓	✓	✓	✓	✓	✓	✓	✓	✓	✓	✓	✓	✓	✓	✓	✓	✓

¹ Not available on 42"-48" wide.

² Not available on 39"-48" wide.

³ FLUT6B not available on 24" wide.

⁴ Not available on 48" wide.

⁵ 18" deep can not be recessed in both the front and back.

⁶ Not available on depths less than 21".

⁷ 18" deep not available, and also not available on 39"-48" wide.

⁸ Not available on 24" wide.

IH/RH availability charts starting on page G-40.
IW/RW availability charts starting on page G-46.

VANITY BASE PULL-OUT, 34 1/2" HIGH, 21" DEEP

L O G I X

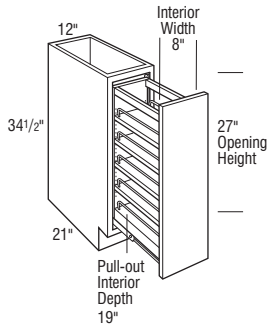

Cubic Feet	1	2	3	4	5	6	7	
VBP1234.5	6.6	1778	1828	1872	1935	2004	2127	2250

- Pull-out features three adjustable shelves with chrome rail sides.

Door & Drawer Options

CC	CG	GAMD	HC	IFHG	MC	MD	MFO	PRMD	SGLPN	SHMD	SPLITDR	SPLITDRWS	TCG	TCP
	✓													

End Panel Options

AUTH	CSFPE	EXBK	EXDN	FFD	FL/FR	FPE	INTGE	IPE
✓	✓	✓			✓	✓	✓	✓

Custom Modification Options

ADD_SHLF	ADDTK	ADRW	BVR	CBO	CCO	CFNT0	CFP	CFRMO	CLIP	CMAT	CND	CSDGBK	DRWTK	EX	EX_OL	FD	FLUT ¹	FTK	ID	IH	INVFRM	IW	
												✓			✓	✓	✓	✓	✓				

MIP	OBRB	PFINBTMB	RD	REC	RECTK	RECTK_6 ²	RECTKERT6	RH	ROSFLUT	RT	SBCADDY	SBCADDYSM	SCPDWR	TBN	TD	TKP	TVR	UDBX	URT	VLSO	VTK	VWB	WS	WTR	
✓	✓					✓	✓		✓														✓	✓	✓

¹ Not available with 6" fluting.

² Can only be recessed in front and/or back.

VANITY BASE without SHELF, 32" or 34 1/2" HIGH, 16" DEEP

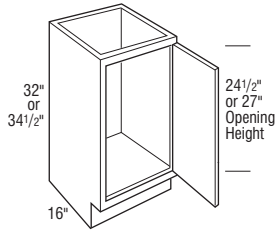

MV183216 L or R	6.6	1160	1215	1255	1329	1401	1536	1671
MV183416 L or R	7.1	1212	1272	1313	1390	1466	1608	1750

- MV = Mini Vanity.

Door & Drawer Options

CC	CG	GAMD	HC	IFHG	MC	MD	MFO	PRMD	SGLPN	SHMD	SPLITDR	SPLITDRWS	TCG	TCP
	✓													

End Panel Options

AUTH	CSFPE	EXBK	EXDN	FFD	FL/FR	FPE	INTGE	IPE
✓	✓	✓			✓	✓	✓	✓

Custom Modification Options

ADD_SHLF	ADDTK	ADRW	BVR	CBO	CCO	CFNT0	CFP	CFRMO	CLIP	CMAT	CND	CSDGBK	DRWTK	EX	EX_OL	FD	FLUT ¹	FTK	ID	IH	INVFRM	IW	
												✓			✓	✓	✓	✓	✓	✓	✓	✓	✓

MIP	OBRB	PFINBTMB	RD	REC	RECTK	RECTK_6 ²	RECTKERT6	RH	ROSFLUT	RT	SBCADDY	SBCADDYSM	SCPDWR	TBN	TD	TKP	TVR	UDBX	URT	VLSO	VTK	VWB	WS	WTR	
✓	✓					✓	✓		✓														✓	✓	✓

¹ 6" fluting not available.

² Can only be recessed in the front and/or one side only.

Vanity Sink Base Cabinets

VANITY SINK BASE with FALSE PANEL, 32" or 34 1/2" HIGH, 18" or 21" DEEP

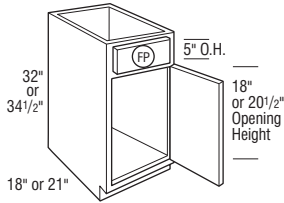

	Cubic Feet	1	2	3	4	5	6	7
VSB183218 L or R	7.4	1067	1112	1153	1219	1292	1401	1510
VSB213218 L or R	8.5	1108	1161	1206	1278	1324	1450	1576
VSB243218 L or R	9.7	1139	1195	1230	1300	1370	1500	1630
VSB183221 L or R	8.9	1067	1112	1153	1219	1292	1401	1510
VSB213221 L or R	10.3	1108	1161	1206	1278	1324	1450	1576
VSB243221 L or R	11.6	1139	1195	1230	1300	1370	1500	1630
VSB183418 L or R	7.9	1113	1164	1207	1277	1350	1466	1582
VSB213418 L or R	9.2	1160	1213	1261	1337	1388	1516	1644
VSB243418 L or R	10.4	1191	1247	1288	1359	1433	1568	1703
VSB183421 L or R	9.5	1113	1164	1207	1277	1350	1466	1582
VSB213421 L or R	11.0	1160	1213	1261	1337	1388	1516	1644
VSB243421 L or R	12.5	1191	1247	1288	1359	1433	1568	1703

Notes below apply to all products in section above:

- Touch-up kit (TUK) and Owner's Guide included.
- Increased Depths available in 1/4" increments from 21 1/4" to 30".
- Reduced Depths available in 1/4" increments from 6" to 20 3/4".

FP False Panel

Door & Drawer Options

CC	CG	GAMD	HC	IFHG	MC	MD	MFO	PRMD	SGLPN	SHMD	SPLITDR ¹	SPLITDRWS ²	TCG	TCP
✓	✓	✓	✓	✓	✓	✓	✓	✓	✓	✓	✓	✓	✓	✓

End Panel Options

AUTH	CSFPE	EXBK	EXDN	FFD	FL/FR	FPE	INTGE	IPE
✓	✓	✓	✓	✓	✓	✓	✓	✓

Custom Modification Options

ADD	SHLF	ADDTK	ADRW	BVR	CBO	CCO	CFNTO	CFP	CFRMO	CLIP	CMAT ³	CND	CSDGBK	DRWTK ⁴	EX	EX_OL	FD	FLUT ⁵	FTK	ID	IH	INVERM	IW ⁶	
✓	✓	✓	✓	✓	✓	✓	✓	✓	✓	✓	✓	✓	✓	✓	✓	✓	✓	✓	✓	✓	✓	✓	✓	✓

MIP	OBRB	PFINBTMB	RD	REC	RECTK	RECTK ⁶	RECTKRT ⁶	RH	ROSFLUT	RT	SBCADDY	SBCADDYSM	SCPDRW	TBN	TD	TKP	TVR	UDBX	URT ⁴	VLSO ⁸	VTK	VWB ⁹	WS	WTR
✓	✓	✓	✓	✓	✓	✓	✓	✓	✓	✓	✓	✓	✓	✓	✓	✓	✓	✓	✓	✓	✓	✓	✓	✓

¹ Not available on 18"×24" (1 door) wide.

² Not available on 18"×24" (1 door and 2 doors) wide.

³ Not available on 18" or 21" wide.

⁴ Not available on 18", 21" or 39" wide.

⁵ Fluting both 6" not available on 18" or 21" wide.

⁶ Not available on 36" wide.

⁷ 18" wide can only be recessed in the front, back, and/or one side only. 18" deep can not be recessed in both the front and back.

⁸ Only available on 34 1/2" high. Not available on depths less than 21". VLSOB only available on 24" wide.

⁹ Not available on depths less than 21".

IH/RH availability charts starting on page G•40.
IW/RW availability charts starting on page G•46.

Vanity Sink Base Cabinets

VANITY SINK BASE with FALSE PANEL, 32" or 34 1/2" HIGH, 18" or 21" DEEP (cont'd)

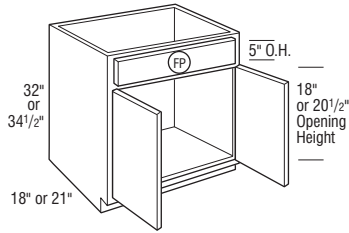

	Cubic Feet	1	2	3	4	5	6	7
VSB243218	9.7	1452	1520	1557	1645	1755	1919	2083
VSB273218	10.9	1580	1658	1719	1807	1915	2097	2279
VSB303218	12.0	1609	1688	1747	1851	1942	2123	2304
VSB333218	13.2	1662	1744	1806	1901	2000	2186	2372
VSB363218	14.3	1710	1795	1856	1952	2068	2265	2462
VSB393218	15.5	1749	1835	1901	2004	2110	2309	2508
VSB243221	11.6	1452	1520	1557	1645	1755	1919	2083
VSB273221	13.0	1580	1658	1719	1807	1915	2097	2279
VSB303221	14.4	1609	1688	1747	1851	1942	2123	2304
VSB333221	15.7	1662	1744	1806	1901	2000	2186	2372
VSB363221	17.1	1710	1795	1856	1952	2068	2265	2462
VSB393221	18.5	1749	1835	1901	2004	2110	2309	2508
VSB243418	10.4	1517	1591	1628	1720	1835	2009	2183
VSB273418	11.7	1652	1733	1796	1890	2001	2192	2383
VSB303418	12.9	1682	1769	1827	1934	2030	2220	2410
VSB333418	14.2	1738	1823	1888	1988	2091	2283	2475
VSB363418	15.4	1786	1876	1944	2043	2163	2367	2571
VSB393418	16.6	1829	1920	1988	2097	2208	2412	2616
VSB243421	12.5	1517	1591	1628	1720	1835	2009	2183
VSB273421	14.0	1652	1733	1796	1890	2001	2192	2383
VSB303421	15.4	1682	1769	1827	1934	2030	2220	2410
VSB333421	16.9	1738	1823	1888	1988	2091	2283	2475
VSB363421	18.4	1786	1876	1944	2043	2163	2367	2571
VSB393421	19.8	1829	1920	1988	2097	2208	2412	2616

Notes below apply to all products in section above:

- Touch-up kit (TUK) and Owner's Guide included.
- Increased Depths available in 1/4" increments from 21 1/4" to 30".
- Reduced Depths available in 1/4" increments from 6" to 20 3/4".

FP False Panel

Door & Drawer Options

CC	CG	GAMD	HC	IFHG	MC	MD	MFO	PRMD	SGLPN	SHMD	SPLITDR ¹	SPLITDRWS ²	TCG	TCP
✓	✓	✓	✓	✓	✓	✓	✓	✓	✓	✓	✓	✓	✓	✓

End Panel Options

AUTH	CSFPE	EXBK	EXDN	FFD	FL/FR	FPE	INTGE	IPE
✓	✓	✓	✓	✓	✓	✓	✓	✓

Custom Modification Options

ADD_SHLF	ADDTK	ADRW	BVR	CBO	CCO	CFNTO	CFP	CFRMO	CLIP	CMAT ³	CND	CSDGBK	DRWTK ⁴	EX	EX_OL	FD	FLUT ⁵	FTK	ID	IH	INVFRM	IW ⁶	
✓	✓	✓	✓	✓	✓	✓	✓	✓	✓	✓	✓	✓	✓	✓	✓	✓	✓	✓	✓	✓	✓	✓	✓

MIP	OBRB	PFINBTMB	RD	REC	RECTK	RECTK_6 ⁷	RECTKFRT6	RH	ROSFLUT	RT	SBCADDY	SBCADDYSM	SCPDWR	TBN	TD	TKP	TVR	UDBX	URT ⁴	VLSO ⁸	VTK	VWB ⁹	WS	WTR
✓	✓	✓	✓	✓	✓	✓	✓	✓	✓	✓	✓	✓	✓	✓	✓	✓	✓	✓	✓	✓	✓	✓	✓	✓

¹ Not available on 18"-24" (1 door) wide.

² Not available on 18"-24" (1 door and 2 doors) wide.

³ Not available on 18" or 21" wide.

⁴ Not available on 18", 21" or 39" wide.

⁵ Fluting both 6" not available on 18" or 21" wide.

⁶ Not available on 36" wide.

⁷ 18" deep can not be recessed in both the front and back.

⁸ Only available on 34 1/2" high. Not available on depths less than 21".

⁹ Not available on depths less than 21".

Vanity Sink Base Cabinets

VANITY SINK BASE with FALSE PANEL, 32" or 34 1/2" HIGH, 18" or 21" DEEP

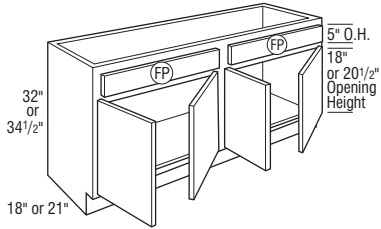
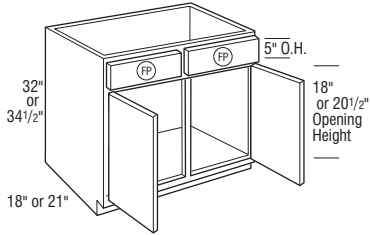

	Cubic Feet	1	2	3	4	5	6	7
VSB423218	16.6	1796	1881	1951	2058	2152	2351	2550
VSB453218	17.8	1881	1979	2048	2160	2270	2476	2682
VSB483218CS	19.0	1976	2070	2145	2265	2385	2603	2821
VSB423221	19.8	1796	1881	1951	2058	2152	2351	2550
VSB453221	21.2	1881	1979	2048	2160	2270	2476	2682
VSB483221CS	22.6	1976	2070	2145	2265	2385	2603	2821
VSB423418	17.9	1877	1970	2040	2152	2250	2458	2666
VSB453418	19.1	1970	2068	2139	2261	2373	2590	2807
VSB483418CS	20.4	2064	2165	2243	2367	2492	2721	2950
VSB423421	21.3	1877	1970	2040	2152	2250	2458	2666
VSB453421	22.8	1970	2068	2139	2261	2373	2590	2807
VSB483421CS	24.2	2064	2165	2243	2367	2492	2721	2950
VSB483218	19.0	2174	2277	2360	2492	2624	2863	3102
VSB483221	22.6	2174	2277	2360	2492	2624	2863	3102
VSB483418	20.4	2126	2230	2310	2438	2567	2803	3039
VSB483421	24.2	2126	2230	2310	2438	2567	2803	3039

- Touch-up kit (TUK) and Owner's Guide included.
- Increased Depths available in 1/4" increments from 21 1/4" to 30".
- Reduced Depths available in 1/4" increments from 6" to 20 3/4".

(FP) False Panel

Door & Drawer Options

CC	CG	GAMD	HC	IFHG	MC	MD	MFO	PRMD	SGLPN	SHMD	SPLITDR ¹	SPLITDRWS ¹	TCG	TCP
✓	✓	✓	✓	✓	✓	✓	✓	✓	✓	✓	✓	✓	✓	✓

End Panel Options

AUTH	CSFPE	EXBK	EXDN	FFD	FL/FR	FPE	INTGE	IPE
✓	✓	✓	✓	✓	✓	✓	✓	✓

Custom Modification Options

ADD	SHLF	ADTK	ADRW	BVR	CBO	CCO	CFNT0	CFP	CFRMO	CLIP	CMAT	CND	CSDGBK	DRWTK	EX	EX_OL	FD	FLUT	FTK	ID	IH	INVFRM	IW ¹	
✓	✓	✓	✓	✓	✓	✓	✓	✓	✓	✓	✓	✓	✓	✓	✓	✓	✓	✓	✓	✓	✓	✓	✓	
MIP	OBRB	PFINBTMB	RD	REC	RECTK	RECTK ²	RECTKRT6	RH	ROSFLUT	RT	SBCADDY	SBCADDYSM	SCPDRW	TBN	TD	TKP	TVR	UDBX	URT	VLSO ³	VTK	VWB ⁴	WS	WTR
✓	✓	✓	✓	✓	✓	✓	✓	✓	✓	✓	✓	✓	✓	✓	✓	✓	✓	✓	✓	✓	✓	✓	✓	

¹ Not available on 48" wide.

² 18" deep can not be recessed in both the front and back.

³ Only available on 34 1/2" high. Not available on depths less than 21".

⁴ Not available on depths less than 21".

IH/RH availability charts starting on page G•40.
IW/RW availability charts starting on page G•46.

VANITY SINK BASE with FALSE PANEL, 32" or 34 1/2" HIGH, 18" or 21" DEEP

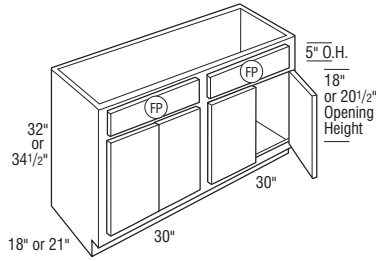
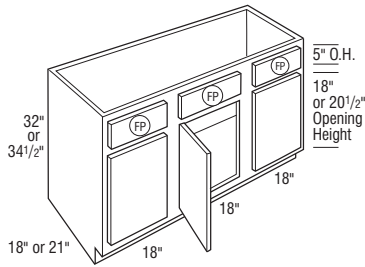

Cubic Feet	1	2	3	4	5	6	7	
VSB543218	21.3	2864	3002	3114	3280	3457	3774	4091
VSB543418	22.9	2994	3143	3255	3427	3619	3948	4277
VSB543221	25.3	2864	3002	3114	3280	3457	3774	4091
VSB543421	27.2	2994	3143	3255	3427	3619	3948	4277
VSB603218	23.6	2938	3083	3196	3369	3536	3866	4196
VSB603418	25.4	3077	3227	3340	3522	3697	4041	4385
VSB603221	28.0	2938	3083	3196	3369	3536	3866	4196
VSB603421	30.1	3077	3227	3340	3522	3697	4041	4385

• Middle door will be hinged left unless specified otherwise.

Notes below apply to all products in section above:

- Touch-up kit (TUK) and Owner's Guide included.
- All false drawer fronts.
- Increased Depths available in 1/4" increments from 21 1/4" to 30".
- Reduced Depths available in 1/4" increments from 6" to 20 3/4".

FP False Panel

Door & Drawer Options

CC	CG	GAMD	HC	IFHG	MC	MD	MFO	PRMD	SGLPN	SHMD	SPLITDR	SPLITDRWS	TCG	TCP
✓	✓	✓	✓	✓	✓	✓	✓	✓	✓	✓	✓	✓	✓	✓

End Panel Options

AUTH	CSFPE	EXBK	EXDN	FFD	FL/FR	FPE	INTGE	IPE
✓	✓	✓	✓	✓	✓	✓	✓	✓

Custom Modification Options

ADD_SHLF	ADDTK	ADRW	BVR	CBO	CCO	CFNTD	CFP	CFRMO	CLIP	CMAT ¹	CND	CSDGBK	DRWTK	EX	EX_OL	FD	FLUT	FTK	ID	IH	INFRM	IW	
✓	✓	✓	✓	✓	✓	✓	✓	✓	✓	✓	✓	✓	✓	✓	✓	✓	✓	✓	✓	✓	✓	✓	✓

MIP	OBRB	PFINBTMB	RD	REC	RECTK	RECTK_6 ²	RECTKFR6	RH	ROSFLUT	RT	SBCADDY	SBCADDYSM	SCPDRW	TBN	TD	TKP	TVR	UDBX	URT	VLSO	VTK	VWB	WS	WTR
✓	✓	✓	✓	✓	✓	✓	✓	✓	✓	✓	✓	✓	✓	✓	✓	✓	✓	✓	✓	✓	✓	✓	✓	✓

¹ Not available on 54" wide.

² 18" deep can not be recessed in both the front and back.

VANITY SINK BASE with U-SHAPED ROLL TRAYS, 34 1/2" HIGH, 21" DEEP

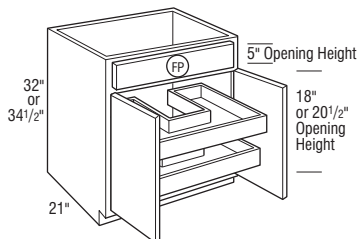

Cubic Feet	1	2	3	4	5	6	7	
VSB303221U	14.1	2319	2398	2457	2561	2652	2833	3014
VSB303421U	15.4	2392	2479	2537	2644	2740	2930	3120

- Includes two wooden U-shaped Smart Roll roll trays.
- Touch-up kit (TUK) and Owner's Guide included.

FP False Panel

Door & Drawer Options

CC	CG	GAMD	HC	IFHG	MC	MD	MFO	PRMD	SGLPN	SHMD	SPLITDR	SPLITDRWS	TCG	TCP
✓	✓	✓	✓	✓	✓	✓	✓	✓	✓	✓	✓	✓	✓	✓

End Panel Options

AUTH	CSFPE	EXBK	EXDN	FFD	FL/FR	FPE	INTGE	IPE
✓	✓	✓	✓	✓	✓	✓	✓	✓

Custom Modification Options

ADD_SHLF	ADDTK	ADRW	BVR	CBO	CCO	CFNTD	CFP	CFRMO	CLIP	CMAT ¹	CND	CSDGBK	DRWTK	EX	EX_OL	FD	FLUT	FTK	ID	IH	INFRM	IW	
✓	✓	✓	✓	✓	✓	✓	✓	✓	✓	✓	✓	✓	✓	✓	✓	✓	✓	✓	✓	✓	✓	✓	✓

MIP	OBRB	PFINBTMB	RD	REC	RECTK	RECTK_6 ²	RECTKFR6	RH	ROSFLUT	RT	SBCADDY	SBCADDYSM	SCPDRW	TBN	TD	TKP	TVR	UDBX	URT	VLSO	VTK	VWB	WS	WTR
✓	✓	✓	✓	✓	✓	✓	✓	✓	✓	✓	✓	✓	✓	✓	✓	✓	✓	✓	✓	✓	✓	✓	✓	✓

U-SHAPED DRAWER ON SELECT BATH BASE CABINETS

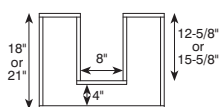

Vanity Sink Base Cabinets

VANITY SINK BASE SUPERCABINET™ with TILT-OUT TRAYS, 34 1/2" HIGH, 21" DEEP

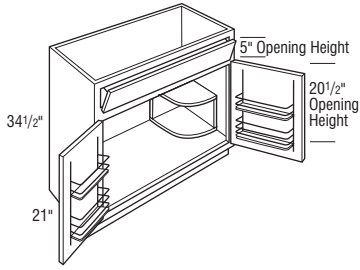

Cubic Feet	1	2	3	4	5	6	7	
VSSB303421ST	15.4	2599	2687	2747	2845	2957	3147	3337
VSSB333421ST	16.9	2644	2727	2790	2896	3004	3197	3390
VSSB363421ST	18.4	2695	2781	2842	2948	3062	3262	3462

- Quarter Round Reversible Shelf for left or right applications included.
- Basket size on 36" door is 14 1/2" W x 20 1/2" H x 3 1/2" D.
- Basket size on 30" and 33" door is 11 1/2" W x 20 1/2" H x 3 1/2" D.
- Touch-up kit (TUK) and Owner's Guide included.
- Door includes a two-tiered non-adjustable chrome rack with wood bottoms.
- Increased Depths available in 1/4" increments from 21 1/4" to 30".
- Not available on Inset and Beaded Inset styles.
- One drawer front with one 1 11/16" deep stainless steel Tilt-out Tray attached.

Door & Drawer Options

CC	CG	GAMD	HC	IFHG	MC	MD	MFO	PRMD	SGLPN	SHMD	SPLITDR	SPLITDRWS	TCG	TCP
----	----	------	----	------	----	----	-----	------	-------	------	---------	-----------	-----	-----

End Panel Options

AUTH	CSFPE	EXBK	EXDN	FFD	FL/FR	FPE	INTGE	IPE
✓	✓	✓	✓	✓	✓	✓	✓	✓

Custom Modification Options

ADD_SHLF	ADDTK	ADRW	BVR	CBO	CCO	CFNTD	CFP	CFRMO	CLIP ¹	CMAT	CND	CSDGBK	DRWTK	EX	EX_OL	FD	FLUT ²	FTK	ID	IH ³	INVERM	IW	
				✓					✓	✓	✓	✓	✓	✓	✓	✓	✓	✓	✓	✓	✓	✓	✓

MIP	OBRB	PFINBTMB	RD	REC	RECTK	RECTK_6	RECTKFRT6	RH	ROSFLUT	RT	SBCADDY	SBCADDYSM	SCPDRW	TBN	TD	TKP	TVR	UBBX	URT	VLSO	VTK	VWB	WS ⁴	WTR
✓	✓			✓				✓								✓	✓				✓	✓	✓	✓

¹ Not available on 30" wide.

² 6" fluting not available on 36" wide.

³ Only available on 36" wide.

⁴ Not available on 30" wide or WSR1.5 and WSL1.5.

IH/RH availability charts starting on page G•40.
IW/RW availability charts starting on page G•46.

Vanity Sink Drawer Base Cabinets

VANITY SINK DRAWER BASE, 32" or 34 1/2" HIGH, 18" or 21" DEEP

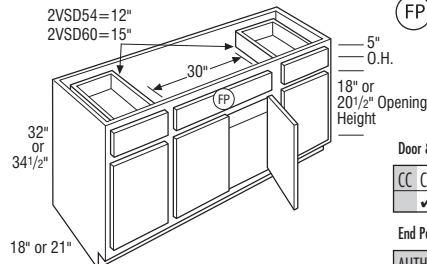
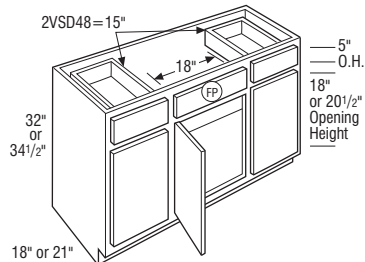
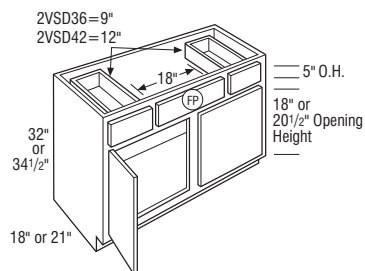

	Cubic Feet	1	2	3	4	5	6	7
2VSD363218†	14.3	1951	2043	2110	2227	2362	2581	2800
2VSD423218	16.6	2180	2283	2367	2500	2629	2868	3107
2VSD363221†	17.1	1951	2043	2110	2227	2362	2581	2800
2VSD423221	19.8	2180	2283	2367	2500	2629	2868	3107
2VSD363418†	15.4	2040	2134	2208	2330	2470	2701	2932
2VSD423418	17.9	2277	2388	2473	2614	2752	2999	3246
2VSD363421†	18.4	2040	2134	2208	2330	2470	2701	2932
2VSD423421	21.3	2277	2388	2473	2614	2752	2999	3246

†Butt doors standard.

2VSD483221 L or R	22.6	2724	2856	2952	3117	3293	3599	3905
2VSD483421 L or R	24.2	2848	2990	3088	3259	3442	3765	4088

• Middle door will be hinged left unless specified otherwise.

2VSD543218FP	21.3	2839	2978	3088	3258	3423	3736	4049
2VSD603218FP	23.6	3120	3272	3393	3580	3762	4106	4450
2VSD543418FP	22.9	2967	3114	3232	3405	3580	3908	4236
2VSD603418FP	25.4	3260	3422	3552	3742	3934	4295	4656
2VSD543221FP	25.3	2993	3139	3244	3425	3619	3955	4291
2VSD603221FP	28.0	3120	3272	3393	3580	3762	4106	4450
2VSD543421FP	27.2	3130	3286	3393	3581	3782	4137	4492
2VSD603421FP	30.1	3260	3422	3552	3742	3934	4295	4656

Notes below apply to all products in section above:

- Touch-up kit (TUK) and Owner's Guide included.
- Two drawers, one false drawer front, center doors butt doors.
- Increased Depths available in 1/4" increments from 21 1/4" to 24".
- Reduced Depths available in 1/4" increments from 12" to 20 3/4".

(FP) False Panel

Door & Drawer Options

CC	CG	GAMD	HC	IFHG	MC	MD	MFO	PRMD	SGLPN	SHMD	SPLITDR ¹	SPLITDRWS	TCG	TCP
✓	✓	✓	✓	✓	✓	✓	✓	✓	✓	✓	✓	✓	✓	✓

End Panel Options

AUTH	CSFPE	EXBK	EXDN	FFD	FL/FR	FPE	INTGE	IPE
✓	✓	✓	✓	✓	✓	✓	✓	✓

Custom Modification Options

ADD_SHLF	ADDTK	ADRW	BVR	CBO	CCO	CFNTO	CFP	CFRMO	CLIP	CMTAT ²	CND	CSDGBK ³	DRWTK ¹	EX	EX_OL	FD	FLUT ⁴	FTK	ID	IH	INFRM	IW	
													✓	✓	✓	✓	✓	✓	✓	✓	✓	✓	✓

MIP	OBRB	PFINBTMB	RD	REC	RECTK	RECTK_6 ⁵	RECTKFRt6	RH	ROSLUT	RT	SBCADDY ⁶	SBCADDYSM ⁶	SCPDRW	TBN	TD ⁶	TKP	TVR ¹	UBXB	URT	VLSO ⁷	VTK	VWB ⁸	WS ⁹	WTR
✓	✓	✓	✓	✓	✓	✓	✓	✓	✓	✓	✓	✓	✓	✓	✓	✓	✓	✓	✓	✓	✓	✓	✓	✓

¹ Only available on 36" wide.

² Only available on 36" and 60" wide.

³ Not available on 54" or 60" wide.

⁴ Not available with 6" fluting.

⁵ 18" deep can not be recessed in both the front and back.

⁶ Only available on 36" and 42" wide.

⁷ Only available on 34 1/2" high. Not available on depths less than 21". Not available with 2VSD483421 L or R. 54" wide not available with VLSOB.

⁸ Not available on depths less than 21".

⁹ Not available on 36" wide. Wide stile both 1.5" also not available on 42" wide.

Vanity Sink Drawer Base Cabinets

**VANITY SINK and TWO DRAWER BASE
with EXTENDED STILES, 32" or
34 1/2" HIGH, 18" or 21" DEEP**

Cubic Feet	1	2	3	4	5	6	7	
2VSD57/603218FP	23.6	3120	3272	3393	3580	3762	4106	4450
2VSD57/603418FP	25.4	3260	3422	3552	3742	3934	4295	4656
2VSD57/603221FP	28.0	3120	3272	3393	3580	3762	4106	4450
2VSD57/603421FP	30.1	3260	3422	3552	3742	3934	4295	4656

- Stiles may be trimmed 1 1/2" per side.
- Touch-up kit (TUK) and Owner's Guide included.
- Two drawers, one false drawer front, center doors butt doors.
- Increased Depths available in 1/4" increments from 21 1/4" to 24".
- Reduced Depths available in 1/4" increments from 12" to 20 3/4".

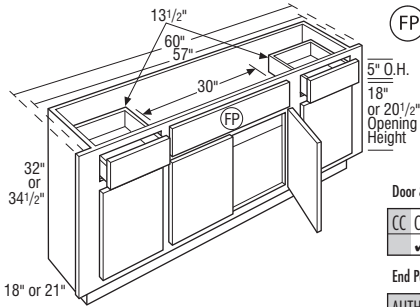

FP False Panel

Door & Drawer Options

CC	CG	GAMD	HC	IFHG	MC	MD	MFO	PRMD	SGLPN	SHMD	SPLITDR	SPLITDRWS	TCG	TCP
✓			✓	✓	✓			✓						

End Panel Options

AUTH	CSFPE	EXBK	EXDN	FFD	FL/FR	FPE	INTGE	IPE
		✓						✓

Custom Modification Options

ADD	SHLF	ADTK	ADRW	BVR	CBO	CCO	CFNTD	CFP	CFRMO	CLIP	CMAT	CND	CSDGBK	DRWTK	EX	EX_OL	FD	FLUT	FTK	ID	IH	INVFRM	IW
					✓	✓	✓	✓	✓			✓								✓	✓		

MIP	OBRB	PFINBTMB	RD	REC	RECTK	RECTK_6 ¹	RECTKRT6	RH	ROSEFLUT	RT	SBCADDY	SBCADDYSM	SCPDRW	TBN	TD	TKP	TVR	UDBX	URT	VLSO	VTK	VWB	WS	WTR
✓	✓		✓	✓	✓	✓	✓		✓	✓						✓					✓		✓	✓

¹ 18" deep can not be recessed in both the front and back.

IH/RH availability charts starting on page G•40.
IW/RW availability charts starting on page G•46.

Vanity Sink Drawer Base Cabinets

VANITY SINK DRAWER BASE with FALSE PANEL, 32" HIGH, 18" or 21" DEEP

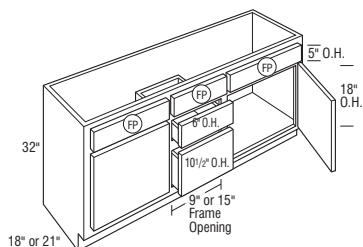
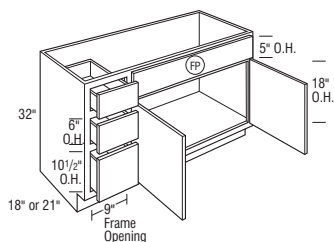
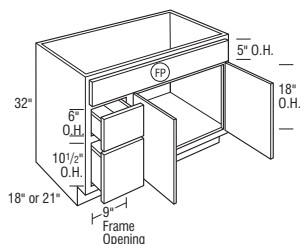
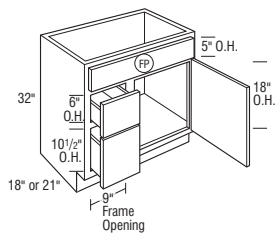

	Cubic Feet	1	2	3	4	5	6	7
VSD243218FP DL or DR	10.2	2101	2202	2277	2400	2535	2769	3003
VSD273218FP DL or DR	11.4	2183	2287	2366	2493	2634	2876	3118
VSD303218FP DL or DR	12.6	2265	2373	2454	2587	2733	2984	3235
VSD333218FP DL or DR	13.8	2442	2559	2646	2789	2947	3218	3489
VSD243221FP DL or DR	11.8	2101	2202	2277	2400	2535	2769	3003
VSD273221FP DL or DR	13.1	2183	2287	2366	2493	2634	2876	3118
VSD303221FP DL or DR	14.5	2265	2373	2454	2587	2733	2984	3235
VSD333221FP DL or DR	15.8	2442	2559	2646	2789	2947	3218	3489

- Door hinges on opposite side of drawer stack.
- DL or DR indicates drawer location.

VSD363218FP DL or DR	15.0	2617	2743	2837	2990	3159	3449	3739
VSD363221FP DL or DR	17.2	2617	2743	2837	2990	3159	3449	3739

- DL or DR indicates drawer location.

VSD423218FP DL or DR	17.3	2843	2980	3082	3248	3432	3747	4062
VSD453218FP DL or DR	18.5	2906	3045	3149	3319	3507	3829	4151
VSD483218FP DL or DR	19.7	2966	3108	3215	3388	3580	3909	4238
VSD423221FP DL or DR	19.9	2843	2980	3082	3248	3432	3747	4062
VSD453221FP DL or DR	21.3	2906	3045	3149	3319	3507	3829	4151
VSD483221FP DL or DR	22.6	2966	3108	3215	3388	3580	3909	4238

- DL or DR indicates drawer location.

VSD543218FP	22.0	3140	3290	3403	3586	3789	4137	4485
VSD603218FP	24.4	3313	3472	3591	3784	3998	4366	4734
VSD543221FP	25.3	3140	3290	3403	3586	3789	4137	4485
VSD603221FP	28.1	3313	3472	3591	3784	3998	4366	4734

- Door hinges on opposite side of drawer stack.

Notes below apply to all products in section above:

- Touch-up kit (TUK) and Owner's Guide included.
- Increased Depths available in 1/4" increments from 21 1/4" to 24".
- Reduced Depths available in 1/4" increments from 12" to 20 3/4".

FP False Panel

Door & Drawer Options

CC	CG	GAMD	HC	IFHG	MC	MD	MFO	PRMD	SGLPN	SHMD	SPLITDR	SPLITDRWS	TCG	TCP
✓			✓		✓			✓						

End Panel Options

AUTH	CSFPE	EXBK	EXDN	FFD	FL/FR	FPE	INTGE	IPE
✓	✓	✓		✓		✓	✓	✓

Custom Modification Options

ADD_SHLF	ADDTK	ADRW	BVR	CBO	CCO	CFNT0	CFP	CFRMO	CLJP	CMAT	CND	CSDGBK	DRWTK	EX	EX_OL	FD	FLUT ¹	FTK	ID ²	IH	INFRM	IW	
								✓	✓	✓	✓	✓	✓	✓	✓	✓	✓	✓	✓	✓	✓	✓	✓

MIP	OBRB	PFINBTMB	RD	REC	RECTK	RECTK_6	RECTKFR6	RH	ROSFLUT ³	RT	SBCADY	SBCADDYSM	SCPDRW	TBN	TD	TKP	TVR	UDBX	URT	VLSO	VTK	VWB	WS ⁴	WTR
✓	✓	✓	✓	✓	✓	✓	✓	✓	✓	✓	✓	✓	✓	✓	✓	✓	✓	✓	✓	✓	✓	✓	✓	✓

¹ Not available with fluting both or 6" fluting.

² Not available on 18" deep.

³ Not available on 24" wide. Not available with 6" fluting or fluting both.

⁴ Not available on wide stile 3" or wide stile both.

Vanity Sink Drawer Base Cabinets

VANITY SINK DRAWER BASE with FALSE PANEL, 34 1/2" HIGH, 18" or 21" DEEP

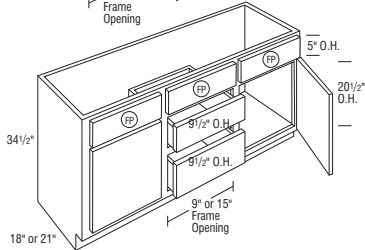
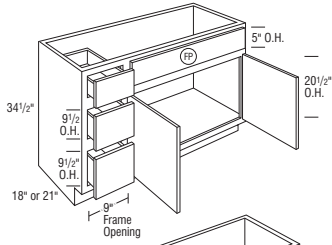
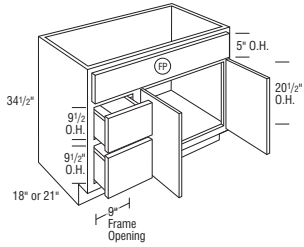
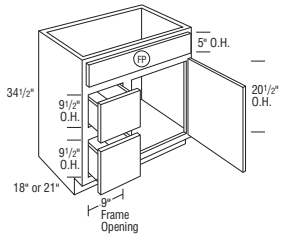

	Cubic Feet	1	2	3	4	5	6	7
VSD243418FP DL or DR	11.0	2374	2488	2573	2711	2865	3128	3391
VSD273418FP DL or DR	12.3	2471	2590	2678	2823	2982	3257	3532
VSD303418FP DL or DR	13.5	2567	2690	2782	2932	3098	3382	3666
VSD333418FP DL or DR	14.8	2767	2900	2999	3161	3340	3647	3954
VSD243421FP DL or DR	12.6	2374	2488	2573	2711	2865	3128	3391
VSD273421FP DL or DR	14.1	2471	2590	2678	2823	2982	3257	3532
VSD303421FP DL or DR	15.5	2567	2690	2782	2932	3098	3382	3666
VSD333421FP DL or DR	17.0	2767	2900	2999	3161	3340	3647	3954

- Door hinges on opposite side of drawer stack.
- DL or DR indicates drawer location.

VSD363418FP DL or DR	16.1	2968	3110	3217	3390	3582	3911	4240
VSD363421FP DL or DR	18.5	2968	3110	3217	3390	3582	3911	4240

- DL or DR indicates drawer location.

VSD423418FP DL or DR	21.4	3204	3358	3472	3660	3867	4222	4577
VSD453418FP DL or DR	22.8	3278	3435	3553	3744	3956	4320	4684
VSD483418FP DL or DR	24.3	3352	3513	3633	3829	4045	4417	4789
VSD423421FP DL or DR	18.6	3204	3358	3472	3660	3867	4222	4577
VSD453421FP DL or DR	19.9	3278	3435	3553	3744	3956	4320	4684
VSD483421FP DL or DR	21.1	3352	3513	3633	3829	4045	4417	4789

- DL or DR indicates drawer location.

VSD543418FP	27.2	3560	3731	3859	4067	4297	4692	5087
VSD603418FP	30.1	3767	3948	4083	4303	4546	4964	5382
VSD543421FP	23.7	3560	3731	3859	4067	4297	4692	5087
VSD603421FP	26.2	3767	3948	4083	4303	4546	4964	5382

- Door hinges on opposite side of drawer stack.

Notes below apply to all products in section above:

- Touch-up kit (TUK) and Owner's Guide included.
- Increased Depths available in 1/4" increments from 21 1/4" to 24".
- Reduced Depths available in 1/4" increments from 12" to 20 3/4".

FP False Panel

Door & Drawer Options

CC	CG	GAMD	HC	IFHG	MC	MD	MFO	PRMD	SGLPN	SHMD	SPLITDR	SPLITDRWS	TCG	TCP
✓	✓	✓	✓	✓	✓	✓	✓	✓	✓	✓	✓	✓	✓	✓

End Panel Options

AUTH	CSFPE	EXBK	EXDN	FFD	FL/FR	FPE	INTGE	IPE
✓	✓	✓	✓	✓	✓	✓	✓	✓

Custom Modification Options

ADD	SHLF	ADTK	ADRW	BVR	CBO	CCO	CFNTD	CFP	CFRMO	CLIP	CMAT	CND	CSDGBK	DRWTK	EX	EX_OL	FD	FLUT ¹	FTK	ID ²	IH	INVRM	IW
✓	✓	✓	✓	✓	✓	✓	✓	✓	✓	✓	✓	✓	✓	✓	✓	✓	✓	✓	✓	✓	✓	✓	✓

MIP	OBRB	PFINBTMB	RD	REC	RECTK	RECTK_6	RECTKFR16	RH	ROSLUT ¹	RT	SBCADDY	SBCADDYSM	SCPDWR	TBN	TD	TKP	TVR	UDBX	URT	VLSD	VTK	VWB	WS ³	WTR
✓	✓	✓	✓	✓	✓	✓	✓	✓	✓	✓	✓	✓	✓	✓	✓	✓	✓	✓	✓	✓	✓	✓	✓	✓

¹ Not available with fluting both or 6" fluting.

² Not available on 18" deep.

³ Not available on wide stile 3" or wide stile both.

IH/RH availability charts starting on page G•40.
IW/RW availability charts starting on page G•46.

Vanity Sink Drawer Base Cabinets

VANITY SINK DRAWER BASE with THREE DRAWERS and FALSE PANEL, 32" HIGH, 18" or 21" DEEP

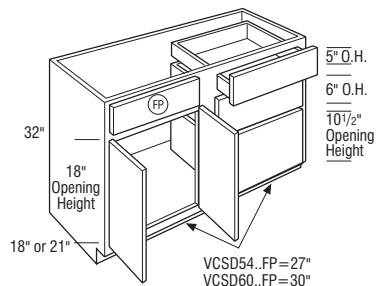
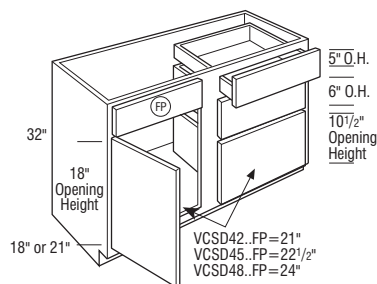
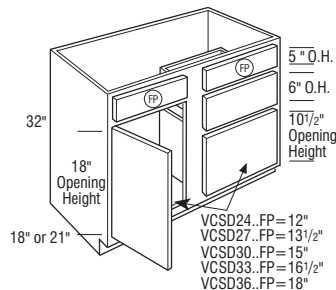

	Cubic Feet	1	2	3	4	5	6	7
VCSD243218FP DL or DR	9.7	1578	1653	1714	1806	1910	2085	2260
VCSD273218FP DL or DR	10.9	1653	1731	1822	1923	2037	2218	2399
VCSD303218FP DL or DR	12.0	1733	1815	1877	1983	2102	2287	2472
VCSD333218FP DL or DR	13.2	1694	1773	1867	1971	2086	2273	2460
VCSD363218FP DL or DR	14.3	1893	1983	2052	2169	2296	2510	2724
VCSD243221FP DL or DR	11.6	1578	1653	1714	1806	1910	2085	2260
VCSD273221FP DL or DR	13.0	1653	1731	1822	1923	2037	2218	2399
VCSD303221FP DL or DR	14.4	1733	1815	1877	1983	2102	2287	2472
VCSD333221FP DL or DR	15.7	1694	1773	1867	1971	2086	2273	2460
VCSD363221FP DL or DR	17.1	1893	1983	2052	2169	2296	2510	2724

VCSD423218FP DL or DR	16.6	2305	2416	2510	2645	2784	3046	3308
VCSD453218FP DL or DR	17.8	2385	2497	2629	2775	2940	3200	3460
VCSD483218FP DL or DR	19.0	2470	2587	2685	2831	2979	3259	3539
VCSD423221FP DL or DR	19.8	2305	2416	2510	2645	2784	3046	3308
VCSD453221FP DL or DR	21.2	2385	2497	2629	2775	2940	3200	3460
VCSD483221FP DL or DR	22.6	2470	2587	2685	2831	2979	3259	3539

VCSD543218FP DL or DR	21.3	2895	3030	3191	3368	3568	3885	4202
VCSD603218FP DL or DR	23.6	3064	3206	3378	3564	3774	4109	4444
VCSD543221FP DL or DR	25.3	2895	3030	3191	3368	3568	3885	4202
VCSD603221FP DL or DR	28.0	3064	3206	3378	3564	3774	4109	4444

Notes below apply to all products in section above:

- DL or DR indicates drawer location.
- Touch-up kit (TUK) and Owner's Guide included.
- Increased Depths available in 1/4" increments from 21 1/4" to 24".
- Reduced Depths available in 1/4" increments from 12" to 20 3/4".

FP False Panel

Door & Drawer Options

CC	CG	GAMD	HC	IFHG	MC	MD	MFO	PRMD	SGLPN	SHMD	SPLITDR	SPLITDRWS	TCG	TCP
✓	✓	✓	✓	✓	✓	✓	✓	✓	✓	✓	✓	✓	✓	✓

End Panel Options

AUTH	CSFPE	EXBK	EXDN	FFD	FL/FR	FPE	INTGE	IPE
✓	✓	✓	✓	✓	✓	✓	✓	✓

Custom Modification Options

ADD	SHLF	ADDTK	ADRW	BVR	CBO	CCO	CFNTO	CFP ¹	CFRMO	CLIP	CMAT ²	CND	CSDGBK	DRWTK ³	EX	EX_OL	FD	FLUT ⁴	FTK	ID	IH	INFRM	IW	
✓	✓	✓	✓	✓	✓	✓	✓	✓	✓	✓	✓	✓	✓	✓	✓	✓	✓	✓	✓	✓	✓	✓	✓	✓

MIP	OBRB	PFINBTMB	RD	REC	RECTK	RECTK ⁵	RECTK ⁶	RH	ROSLUT	RT	SBCADDY	SBCADDYSM	SCPDWR ¹	TBN	TD	TKP	TVR	UDBX	URT	VLSO	VTK	VWB ⁶	WS ⁷	WTR
✓	✓	✓	✓	✓	✓	✓	✓	✓	✓	✓	✓	✓	✓	✓	✓	✓	✓	✓	✓	✓	✓	✓	✓	✓

¹ Only available on 42"-60" wide.

² Only available on 48" (1 door and 2 doors)-60" wide.

³ Only available on 24"-36" wide.

⁴ Not available with 6" fluting.

⁵ 18" deep can not be recessed in both the front and back.

⁶ Not available on depths less than 21".

⁷ Not available on 24" wide.

Vanity Sink Drawer Base Cabinets

VANITY SINK DRAWER BASE with THREE DRAWERS and FALSE PANEL, 34 1/2" HIGH, 18" or 21" DEEP

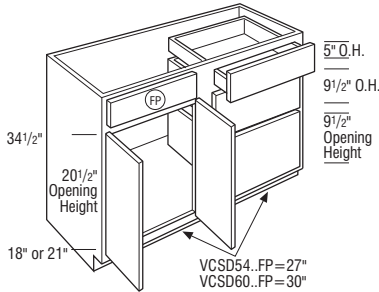
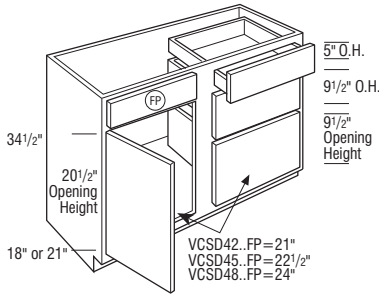
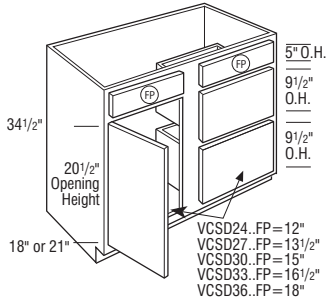

	Cubic Feet	1	2	3	4	5	6	7
VCSD243418FP DL or DR	10.4	1651	1731	1794	1888	1997	2182	2367
VCSD273418FP DL or DR	11.7	1731	1811	1908	2013	2131	2321	2511
VCSD303418FP DL or DR	12.9	1815	1897	1963	2073	2196	2391	2586
VCSD333418FP DL or DR	14.2	1892	1979	2085	2202	2330	2538	2746
VCSD363418FP DL or DR	15.4	1982	2073	2145	2270	2400	2620	2840
VCSD243421FP DL or DR	12.5	1651	1731	1794	1888	1997	2182	2367
VCSD273421FP DL or DR	14.0	1731	1811	1908	2013	2131	2321	2511
VCSD303421FP DL or DR	15.4	1815	1897	1963	2073	2196	2391	2586
VCSD333421FP DL or DR	16.9	1892	1979	2085	2202	2330	2538	2746
VCSD363421FP DL or DR	18.4	1982	2073	2145	2270	2400	2620	2840
VCSD423418FP DL or DR	17.9	2409	2526	2620	2765	2908	3185	3462
VCSD453418FP DL or DR	19.1	2495	2613	2752	2903	3075	3349	3623
VCSD483418FP DL or DR	20.4	2582	2710	2805	2962	3117	3409	3701
VCSD423421FP DL or DR	21.3	2409	2526	2620	2765	2908	3185	3462
VCSD453421FP DL or DR	22.8	2495	2613	2752	2903	3075	3349	3623
VCSD483421FP DL or DR	24.2	2582	2710	2805	2962	3117	3409	3701
VCSD543418FP DL or DR	22.9	2761	2888	3043	3212	3400	3703	4006
VCSD603418FP DL or DR	25.4	3181	3328	3506	3699	3919	4267	4615
VCSD543421FP DL or DR	27.2	2761	2888	3043	3212	3400	3703	4006
VCSD603421FP DL or DR	30.1	3181	3328	3506	3699	3919	4267	4615

Notes below apply to all products in section above:

- DL or DR indicates drawer location.
- Touch-up kit (TUK) and Owner's Guide included.
- Increased Depths available in 1/4" increments from 21 1/4" to 24".
- Reduced Depths available in 1/4" increments from 12" to 20 3/4".

FP False Panel

Door & Drawer Options

CC	CG	GAMD	HC	IFHG	MC	MD	MFO	PRMD	SGLPN	SHMD	SPLITDR	SPLITDRWS	TCG	TCP
✓	✓	✓	✓	✓	✓	✓	✓	✓	✓	✓	✓	✓	✓	✓

End Panel Options

AUTH	CSFPE	EXBK	EXDN	FFD	FL/FR	FPE	INTGE	IPE
✓	✓	✓	✓	✓	✓	✓	✓	✓

Custom Modification Options

ADD	SHLF	ADTK	ADRW	BVR	CBO	CCO	CFNT0	CFP ¹	CFRMO	CLIP	CMA ²	CND	CSDGBK	DRWTK ³	EX	EX_OL	FD	FLUT ⁴	FTK	ID	IH	INVERM	IW	
✓	✓	✓	✓	✓	✓	✓	✓	✓	✓	✓	✓	✓	✓	✓	✓	✓	✓	✓	✓	✓	✓	✓	✓	✓
MIP	OBRB	PFINBTMB	RD	REC	RECTK	RECTK ⁵	RECTKRT ⁶	RH	ROSFLUT	RT	SBCADDY	SBCADDYSM	SCPDRW ¹	TBN	TD	TKP	TVR	UDBX	URT	VLSO ⁶	VTK	VWB ⁷	WS ⁸	WTR
✓	✓	✓	✓	✓	✓	✓	✓	✓	✓	✓	✓	✓	✓	✓	✓	✓	✓	✓	✓	✓	✓	✓	✓	✓

¹ Only available on 42"-60" wide.

² Only available on 48" (1 door and 2 doors)-60" wide.

³ Only available on 24"-36" wide.

⁴ Not available with 6" fluting.

⁵ 18" deep can not be recessed in both the front and back.

⁶ Not available on depths less than 21". VLSOB not available on 24"-45" wide, 24"-27" wide not available.

⁷ Not available on depths less than 21".

⁸ Not available on 24" wide.

IH/RH availability charts starting on page G-40.
IW/RW availability charts starting on page G-46.

Vanity Sink Drawer Base Cabinets

VANITY SINK BASE with THREE DRAWERS, 32" HIGH, 18" or 21" DEEP

	Cubic Feet	1	2	3	4	5	6	7
VS3D543218	22.0	3529	3699	3825	4032	4260	4651	5042
VS3D603218	24.4	3703	3880	4013	4230	4469	4880	5291
VS3D543221	25.3	3529	3699	3825	4032	4260	4651	5042
VS3D603221	28.1	3703	3880	4013	4230	4469	4880	5291

- Notes below apply to all products in section above:
- Door hinges on opposite side of drawer stack.
 - Touch-up kit (TUK) and Owner's Guide included.
 - Increased Depths available in 1/4" increments from 21 1/4" to 24".
 - Reduced Depths available in 1/4" increments from 12" to 20 3/4".

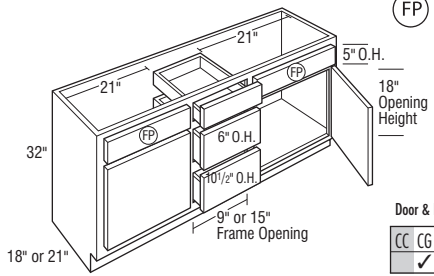

(FP) False Panel

Door & Drawer Options

CC	CG	GAMD	HC	IFHG	MC	MD	MFO	PRMD	SGLPN	SHMD	SPLITDR	SPLITDRWS	TCG	TCP
✓	✓	✓	✓	✓	✓	✓	✓	✓	✓	✓	✓	✓	✓	✓

End Panel Options

AUTH	CSFPE	EXBK	EXDN	FFD	FL/FR	FPE	INTGE	IPE
✓	✓	✓	✓	✓	✓	✓	✓	✓

Custom Modification Options

ADD_SHLF	ADDTK	ADRW	BVR	CBO	CCO	CFNTO	CFP	CFRMO	CLIP	CMAT	CND	CSDGBK	DRWTK	EX	EX_QL	FD	FLUT ¹	FTK	ID ²	IH	INVERM	IW		
				✓	✓	✓	✓	✓	✓	✓	✓	✓	✓	✓	✓	✓	✓	✓	✓	✓	✓	✓	✓	
MIP	OBRB	PFINBTMB	RD	REC	RECTK	RECTK_6	RECTKFR6	RH	ROSLUT ¹	RT	SBCADDY	SBCADDYSM	SCPDRW	TBN	TD	TKP	TVR	UDBX	URT	VLSO	VTK	VWB	WS ³	WTR
✓	✓	✓	✓	✓	✓	✓	✓	✓	✓	✓	✓	✓	✓	✓	✓	✓	✓	✓	✓	✓	✓	✓	✓	✓

¹ Not available with fluting both or 6" fluting.
² Not available on 18" deep.
³ Only available with wide stile 1.5".

VANITY SINK BASE with THREE DRAWERS, 34 1/2" HIGH, 18" or 21" DEEP

VS3D543418	23.7	3950	4140	4281	4512	4768	5206	5644
VS3D603418	25.8	4157	4356	4505	4748	5017	5478	5939
VS3D543421	27.2	3950	4140	4281	4512	4768	5206	5644
VS3D603421	30.1	4157	4356	4505	4748	5017	5478	5939

- Notes below apply to all products in section above:
- Door hinges on opposite side of drawer stack.
 - Touch-up kit (TUK) and Owner's Guide included.
 - Increased Depths available in 1/4" increments from 21 1/4" to 24".
 - Reduced Depths available in 1/4" increments from 12" to 20 3/4".

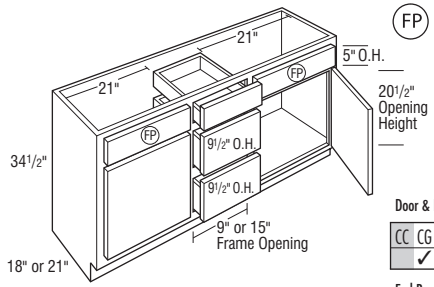

(FP) False Panel

Door & Drawer Options

CC	CG	GAMD	HC	IFHG	MC	MD	MFO	PRMD	SGLPN	SHMD	SPLITDR	SPLITDRWS	TCG	TCP
✓	✓	✓	✓	✓	✓	✓	✓	✓	✓	✓	✓	✓	✓	✓

End Panel Options

AUTH	CSFPE	EXBK	EXDN	FFD	FL/FR	FPE	INTGE	IPE
✓	✓	✓	✓	✓	✓	✓	✓	✓

Custom Modification Options

ADD_SHLF	ADDTK	ADRW	BVR	CBO	CCO	CFNTO	CFP	CFRMO	CLIP	CMAT	CND	CSDGBK	DRWTK	EX	EX_QL	FD	FLUT ¹	FTK	ID ²	IH	INVERM	IW		
				✓	✓	✓	✓	✓	✓	✓	✓	✓	✓	✓	✓	✓	✓	✓	✓	✓	✓	✓	✓	✓
MIP	OBRB	PFINBTMB	RD	REC	RECTK	RECTK_6 ³	RECTKFR6	RH	ROSLUT ¹	RT	SBCADDY	SBCADDYSM	SCPDRW	TBN	TD	TKP	TVR	UDBX	URT	VLSO	VTK	VWB	WS ⁴	WTR
✓	✓	✓	✓	✓	✓	✓	✓	✓	✓	✓	✓	✓	✓	✓	✓	✓	✓	✓	✓	✓	✓	✓	✓	✓

¹ Not available with fluting both or 6" fluting.
² Not available on 18" deep.
³ 18" deep can not be recessed in both the front and back.
⁴ Only available with wide stile 1.5".

Vanity Sink Drawer Base Cabinets

VANITY SINK DRAWER BASE with FOUR DRAWERS and FALSE PANEL, 32" HIGH, 21" DEEP

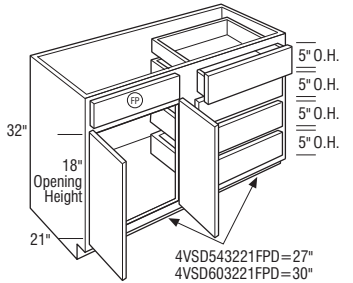
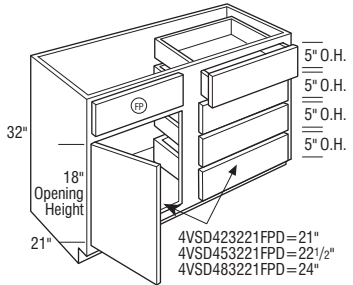
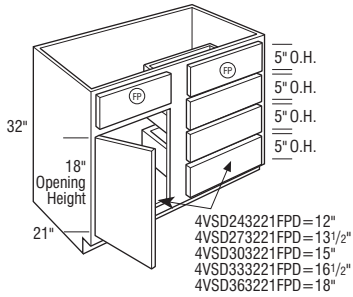

	Cubic Feet	1	2	3	4	5	6	7
4VSD243221FPD L or R	11.6	1894	1983	2057	2166	2292	2503	2714
4VSD273221FPD L or R	13.0	1983	2078	2186	2308	2444	2662	2880
4VSD303221FPD L or R	14.4	2080	2177	2254	2380	2522	2745	2968
4VSD333221FPD L or R	15.7	2032	2127	2240	2366	2505	2729	2953
4VSD363221FPD L or R	17.1	2271	2380	2462	2603	2754	3011	3268
4VSD423221FPD L or R	19.8	2767	2898	3011	3175	3341	3655	3969
4VSD453221FPD L or R	21.2	2863	2995	3155	3330	3528	3841	4154
4VSD483221FPD L or R	22.6	2965	3105	3223	3397	3576	3911	4246
4VSD543221FPD L or R	25.3	3474	3636	3830	4041	4281	4661	5041
4VSD603221FPD L or R	28.0	3677	3846	4053	4276	4530	4932	5334

Notes below apply to all products in section above:

- Door will be hinged on the opposite side of the drawer stack unless specified otherwise.
- Touch-up kit (TUK) and Owner's Guide included.
- Increased Depths available in 1/4" increments from 21 1/4" to 24".
- Reduced Depths available in 1/4" increments from 12" to 20 3/4".

FP False Panel

Door & Drawer Options

CC	CG	GAMD	HC	IFHG	MC	MD	MFO	PRMD	SGLPN	SHMD	SPLITDR	SPLITDRWS	TCG	TCP
✓	✓	✓	✓	✓	✓	✓	✓	✓	✓	✓	✓	✓	✓	✓

End Panel Options

AUTH	CSFPE	EXBK	EXDN	FFD	FL/FR	FPE	INTGE	IPE
✓	✓	✓	✓	✓	✓	✓	✓	✓

Custom Modification Options

ADD_SHLF	ADDTK	ADRW	BVR	CBO	CCO	CFNTO	CFP ¹	CFRMO	CLIP ²	CMAT ³	CND	CSDGBK	DRWTK ⁴	EX	EX_OL	FD	FLUT ⁵	FTK	ID	IH	INVFRM	IW	
✓	✓	✓	✓	✓	✓	✓	✓	✓	✓	✓	✓	✓	✓	✓	✓	✓	✓	✓	✓	✓	✓	✓	✓

MIP	OBRB	PFINBTMB	RD	REC	RECTK	RECTK_6	RECTKFR76	RH	ROSFLUT ⁶	RT	SBCADDY	SBCADDYSM	SCPDRW ¹	TBN	TD	TKP	TVR	UDBX	URT	VLSO	VTK	VWB	WS	WTR
✓	✓	✓	✓	✓	✓	✓	✓	✓	✓	✓	✓	✓	✓	✓	✓	✓	✓	✓	✓	✓	✓	✓	✓	✓

¹ Only available on 42"-60" wide.

² Not available on 24"-27" wide.

³ Only available on 48" (1 door and 2 doors)-60" wide.

⁴ Only available on 24"-36" wide.

⁵ Not available on 24"-27" wide. 6" fluting not available on 30" wide.

⁶ Not available on 24"-27" wide.

IH/RH availability charts starting on page G•40.
IW/RW availability charts starting on page G•46.

Vanity Sink Drawer Base Cabinets

VANITY SINK DRAWER BASE with FOUR DRAWERS and FALSE PANEL, 34 1/2" HIGH, 21" DEEP

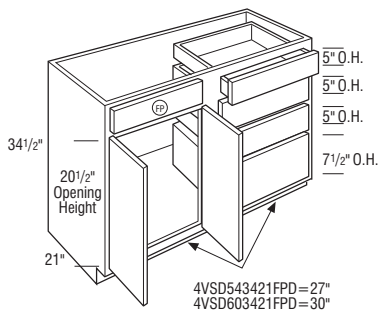
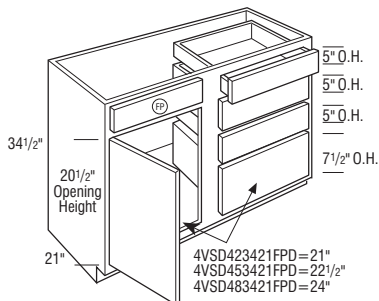
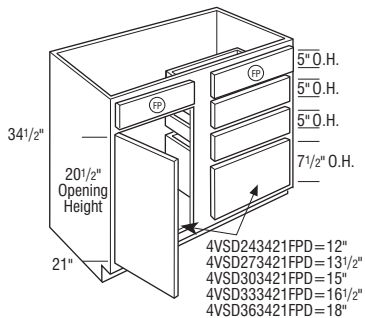

	Cubic Feet	1	2	3	4	5	6	7
4VSD243421FPD L or R	12.5	1981	2078	2152	2267	2396	2619	2842
4VSD273421FPD L or R	14.0	2078	2172	2289	2415	2558	2785	3012
4VSD303421FPD L or R	15.4	2177	2276	2356	2487	2634	2870	3106
4VSD333421FPD L or R	16.9	2270	2375	2503	2641	2796	3046	3296
4VSD363421FPD L or R	18.4	2378	2487	2574	2724	2880	3144	3408
4VSD423421FPD L or R	21.3	2890	3031	3144	3319	3489	3822	4155
4VSD453421FPD L or R	22.8	2994	3134	3301	3483	3691	4019	4347
4VSD483421FPD L or R	24.2	3099	3251	3366	3554	3740	4090	4440
4VSD543421FPD L or R	27.2	3313	3467	3652	3853	4080	4443	4806
4VSD603421FPD L or R	30.1	3818	3993	4206	4440	4703	5121	5539

Notes below apply to all products in section above:

- Door will be hinged on the opposite side of the drawer stack unless specified otherwise.
- Touch-up kit (TUK) and Owner's Guide included.
- Increased Depths available in 1/4" increments from 21 1/4" to 24".
- Reduced Depths available in 1/4" increments from 12" to 20 3/4".

FP False Panel

Door & Drawer Options

CC	CG	GAMD	HC	IFHG	MC	MD	MFO	PRMD	SGLPN	SHMD	SPLITDR	SPLITDRWS	TCG	TCP
✓	✓		✓	✓	✓	✓	✓	✓		✓				

End Panel Options

AUTH	CSFPE	EXBK	EXDN	FFD	FL/FR	FPE	INTGE	IPE
✓	✓	✓	✓	✓	✓	✓	✓	✓

Custom Modification Options

ADD_SHLF	ADDTK	ADRW	BVR	CBO	CCO	CFNTO	CFP ¹	CFRMO	CLIP ²	CMAT ³	CND	CSDGBK	DRWTK ⁴	EX	EX_OL	FD	FLUT ⁵	FTK	ID	IH	INVFRM	IW	
							✓	✓	✓	✓	✓	✓	✓	✓	✓	✓	✓	✓	✓	✓	✓	✓	✓

MIP	OBRB	PFINBTMB	RD	REC	RECTK	RECTK_6	RECTKFR ⁶	RH	ROSFLUT ⁶	RT	SBCADDY	SBCADDYSM	SCPDWR ¹	TBN	TD	TKP	TVR	UDBX	URT	VLSO	VTK	VWB	WS	WTR
✓	✓		✓				✓		✓		✓	✓	✓				✓					✓	✓	✓

¹ Only available on 42"-60" wide.

² Not available on 24"-27" wide.

³ Only available on 48" (1 door and 2 doors)-60" wide.

⁴ Only available on 24"-36" wide.

⁵ Not available on 24"-27" wide. 6" fluting not available on 30" wide.

⁶ Not available on 24"-27" wide.

Vanity Combination Drawer Base Cabinets

VANITY COMBINATION DRAWER BASE with THREE DRAWERS, 32" HIGH, 21" DEEP

VCDB423221D=12"
VCDB483221D=15"
VCDB543221D=18"
VCDB603221D=21"

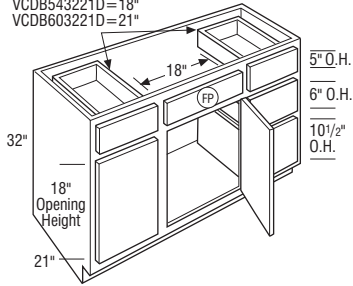

	Cubic Feet	1	2	3	4	5	6	7
VCDB423221D L or R	19.8	3002	3160	3260	3444	3622	3965	4308
VCDB483221D L or R	22.6	3064	3226	3326	3515	3694	4042	4390
VCDB543221D L or R	25.3	3165	3320	3430	3623	3811	4165	4519
VCDB603221D L or R	28.0	3229	3384	3501	3695	3881	4248	4615

- Middle door hinged same side as drawer stack unless specified otherwise.
- Touch-up kit (TUK) and Owner's Guide included.
- Increased Depths available in 1/4" increments from 21 1/4" to 24".
- Reduced Depths available in 1/4" increments from 12" to 20 3/4".

(FP) False Panel

Door & Drawer Options

CC	CG	GAMD	HC	IFHG	MC	MD	MFO	PRMD	SGLPN	SHMD	SPLITDR	SPLITDRWS	TCG	TCP
✓	✓	✓	✓	✓	✓	✓	✓	✓	✓	✓	✓	✓	✓	✓

End Panel Options

AUTH	CSFPE	EXBK	EXDN	FFD	FL/FR	FPE	INTGE	IPE
✓	✓	✓	✓	✓	✓	✓	✓	✓

Custom Modification Options

ADD	SHLF	ADTK	ADRW	BVR	CBO	CCO	CFNTD	CFP	CFRMO	CLIP	CMAT	CND	CSDGBK ¹	DRWTK	EX	EX_OL	FD	FLUT ²	FTK	ID	IH	INFRM	IW	
✓	✓	✓	✓	✓	✓	✓	✓	✓	✓	✓	✓	✓	✓	✓	✓	✓	✓	✓	✓	✓	✓	✓	✓	✓

MIP	OBRB	PFINBTMB	RD	REC	RECTK	RECTK_6	RECTKFR16	RH	ROSFLUT	RT	SBCADDY	SBCADDYSM	SCPDWR	TBN	TD	TKP	TVR	UDBX	URT	VLSO ³	VTK	VWB	WS ³	WTR
✓	✓	✓	✓	✓	✓	✓	✓	✓	✓	✓	✓	✓	✓	✓	✓	✓	✓	✓	✓	✓	✓	✓	✓	✓

¹ Only available on 42" and 48" wide.

² Not available with 6" fluting.

³ Wide stile both 1.5" not available on 42" wide.

VANITY COMBINATION DRAWER BASE with THREE DRAWERS, 34 1/2" HIGH, 21" DEEP

VCDB423421D=12"
VCDB483421D=15"
VCDB543421D=18"
VCDB603421D=21"

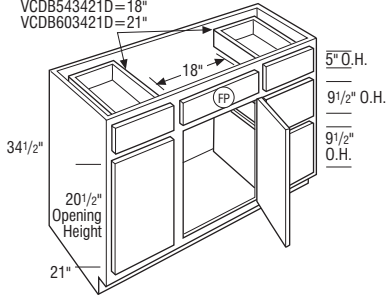

	Cubic Feet	1	2	3	4	5	6	7
VCDB423421D L or R	21.3	3143	3304	3413	3596	3785	4144	4503
VCDB483421D L or R	24.2	3207	3372	3481	3675	3864	4227	4590
VCDB543421D L or R	27.2	3310	3470	3588	3786	3985	4359	4733
VCDB603421D L or R	30.1	3377	3538	3663	3866	4056	4442	4828

- Middle door hinged same side as drawer stack unless specified otherwise.
- Touch-up kit (TUK) and Owner's Guide included.
- Increased Depths available in 1/4" increments from 21 1/4" to 24".
- Reduced Depths available in 1/4" increments from 12" to 20 3/4".

(FP) False Panel

Door & Drawer Options

CC	CG	GAMD	HC	IFHG	MC	MD	MFO	PRMD	SGLPN	SHMD	SPLITDR	SPLITDRWS	TCG	TCP
✓	✓	✓	✓	✓	✓	✓	✓	✓	✓	✓	✓	✓	✓	✓

End Panel Options

AUTH	CSFPE	EXBK	EXDN	FFD	FL/FR	FPE	INTGE	IPE
✓	✓	✓	✓	✓	✓	✓	✓	✓

Custom Modification Options

ADD	SHLF	ADTK	ADRW	BVR	CBO	CCO	CFNTD	CFP	CFRMO	CLIP	CMAT	CND	CSDGBK ¹	DRWTK	EX	EX_OL	FD	FLUT ²	FTK	ID	IH	INFRM	IW
✓	✓	✓	✓	✓	✓	✓	✓	✓	✓	✓	✓	✓	✓	✓	✓	✓	✓	✓	✓	✓	✓	✓	✓

MIP	OBRB	PFINBTMB	RD	REC	RECTK	RECTK_6	RECTKFR16	RH	ROSFLUT	RT	SBCADDY	SBCADDYSM	SCPDWR	TBN	TD	TKP	TVR	UDBX	URT	VLSO ³	VTK	VWB	WS	WTR
✓	✓	✓	✓	✓	✓	✓	✓	✓	✓	✓	✓	✓	✓	✓	✓	✓	✓	✓	✓	✓	✓	✓	✓	✓

¹ Only available on 42" and 48" wide.

² Not available with 6" fluting.

³ VLSOB not available.

IH/RH availability charts starting on page G-40.
IW/RW availability charts starting on page G-46.

Vanity Combination Drawer Base Cabinets

VANITY COMBINATION DRAWER BASE with FOUR DRAWERS, 32" HIGH, 21" DEEP

4VCDB423221D=12"
4VCDB483221D=15"
4VCDB543221D=18"
4VCDB603221D=21"

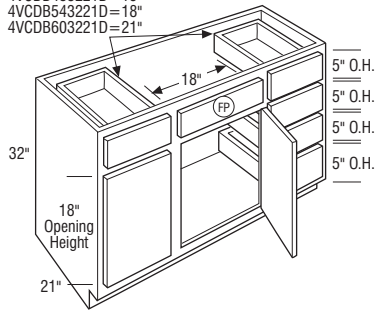

	Cubic Feet	1	2	3	4	5	6	7
4VCDB423221D L or R	19.8	3601	3791	3912	4133	4345	4757	5169
4VCDB483221D L or R	22.6	3677	3871	3992	4217	4434	4851	5268
4VCDB543221D L or R	25.3	3798	3985	4116	4347	4573	4998	5423
4VCDB603221D L or R	28.0	3875	4062	4201	4435	4657	5098	5539

- Middle door hinged same side as drawer stack unless specified otherwise.
- Touch-up kit (TUK) and Owner's Guide included.
- Increased Depths available in 1/4" increments from 21 1/4" to 24".
- Reduced Depths available in 1/4" increments from 12" to 20 3/4".

(FP) False Panel

Door & Drawer Options

CC	CG	GAMD	HC	IFHG	MC	MD	MFO	PRMD	SGLPN	SHMD	SPLITDR	SPLITDRWS	TCG	TCP
✓	✓	✓	✓	✓	✓	✓	✓	✓	✓	✓	✓	✓	✓	✓

End Panel Options

AUTH	CSFPE	EXBK	EXDN	FFD	FL/FR	FPE	INTGE	IPE
✓	✓	✓	✓	✓	✓	✓	✓	✓

Custom Modification Options

ADD_SHLF	ADDTK	ADRW	BVR	CBO	CCO	CFNTO	CFP	CFRMO	CLIP	CMAT	CND	CSDGBK	DRWTK	EX	EX_OL	FD	FLUT ¹	FTK	ID	IH	INVFRM	IW	
✓	✓	✓	✓	✓	✓	✓	✓	✓	✓	✓	✓	✓	✓	✓	✓	✓	✓	✓	✓	✓	✓	✓	✓

MIP	OBRB	PFINBTMB	RD	REC	RECTK	RECTK_6	RECTKFRT6	RH	ROSFLUT	RT	SBCADDY	SBCADDYSM	SCPDRW	TBN	TD	TKP	TVR	UDBX	URT	VLSO	VTK	VWB	WS	WTR
✓	✓	✓	✓	✓	✓	✓	✓	✓	✓	✓	✓	✓	✓	✓	✓	✓	✓	✓	✓	✓	✓	✓	✓	✓

¹ Not available with 6" fluting.

VANITY COMBINATION DRAWER BASE with FOUR DRAWERS, 34 1/2" HIGH, 21" DEEP

4VCDB423421D=12"
4VCDB483421D=15"
4VCDB543421D=18"
4VCDB603421D=21"

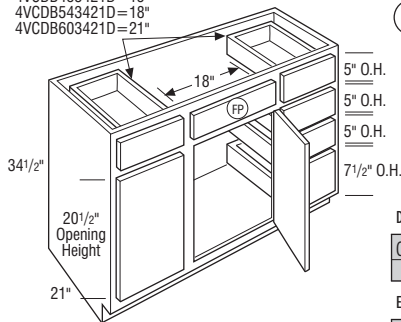

	Cubic Feet	1	2	3	4	5	6	7
4VCDB423421D L or R	21.3	3773	3965	4094	4315	4542	4974	5406
4VCDB483421D L or R	24.2	3848	4046	4178	4409	4637	5072	5507
4VCDB543421D L or R	27.2	3972	4164	4306	4544	4782	5231	5680
4VCDB603421D L or R	30.1	4052	4245	4395	4639	4868	5332	5796

- Middle door hinged same side as drawer stack unless specified otherwise.
- Touch-up kit (TUK) and Owner's Guide included.
- Increased Depths available in 1/4" increments from 21 1/4" to 24".
- Reduced Depths available in 1/4" increments from 12" to 20 3/4".

(FP) False Panel

Door & Drawer Options

CC	CG	GAMD	HC	IFHG	MC	MD	MFO	PRMD	SGLPN	SHMD	SPLITDR	SPLITDRWS	TCG	TCP
✓	✓	✓	✓	✓	✓	✓	✓	✓	✓	✓	✓	✓	✓	✓

End Panel Options

AUTH	CSFPE	EXBK	EXDN	FFD	FL/FR	FPE	INTGE	IPE
✓	✓	✓	✓	✓	✓	✓	✓	✓

Custom Modification Options

ADD_SHLF	ADDTK	ADRW	BVR	CBO	CCO	CFNTO	CFP	CFRMO	CLIP	CMAT	CND	CSDGBK	DRWTK	EX	EX_OL	FD	FLUT ¹	FTK	ID	IH	INVFRM	IW	
✓	✓	✓	✓	✓	✓	✓	✓	✓	✓	✓	✓	✓	✓	✓	✓	✓	✓	✓	✓	✓	✓	✓	✓

MIP	OBRB	PFINBTMB	RD	REC	RECTK	RECTK_6	RECTKFRT6	RH	ROSFLUT	RT	SBCADDY	SBCADDYSM	SCPDRW	TBN	TD	TKP	TVR	UDBX	URT	VLSO	VTK	VWB	WS	WTR
✓	✓	✓	✓	✓	✓	✓	✓	✓	✓	✓	✓	✓	✓	✓	✓	✓	✓	✓	✓	✓	✓	✓	✓	✓

¹ Not available with 6" fluting.

Vanity Console Drawer Base Cabinets

	Cubic Feet	1	2	3	4	5	6	7	
VANITY CONSOLE DRAWER BASE with SIX DRAWERS, 32" HIGH, 21" DEEP	6VCDB42321 L or R	19.8	3602	3793	3912	4133	4346	4758	5170
	6VCDB483221 L or R	22.6	3677	3870	3992	4217	4434	4851	5268
	6VCDB543221 L or R	25.3	3799	3985	4116	4347	4574	4998	5422
	6VCDB603221 L or R	28.0	3875	4061	4201	4435	4657	5098	5539

• Specify L or R hinge for center door.

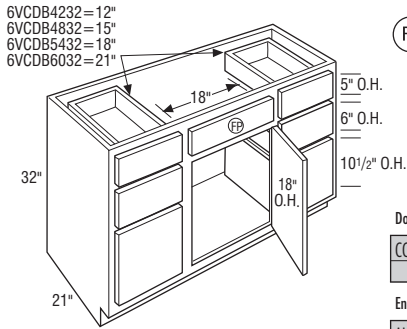

FP False Panel

Door & Drawer Options

CC	CG	GAMD	HC	IFHG	MC	MD	MFO	PRMD	SGLPN	SHMD	SPLITDR	SPLITDRWS	TCG	TCP
✓	✓	✓	✓	✓	✓	✓	✓	✓	✓	✓	✓	✓	✓	✓

End Panel Options

AUTH	CSFPE	EXBK	EXDN	FFD	FL/FR	FPE	INTGE	IPE
✓	✓	✓	✓	✓	✓	✓	✓	✓

Custom Modification Options

ADD	SHLF	ADTK	ADRW	BVR	CBO	CCO	CFNTO	CFP	CFRMO	CLIP	CMAT	CND	CSDGBK ¹	DRWTK	EX	EX_OL	FD	FLUT ²	FTK	ID	IH	INVFRM	IW	
✓	✓	✓	✓	✓	✓	✓	✓	✓	✓	✓	✓	✓	✓	✓	✓	✓	✓	✓	✓	✓	✓	✓	✓	✓

MIP	OBRB	PFINBTMB	RD	REC	RECTK	RECTK ⁶	RECTKFR76	RH	ROSFLUT	RT	SBCADDY	SBCADDYSM	SCPDRW	TBN	TD	TKP	TVR	UDBX	URT	VLSO	VTK	VWB	WS ³	WTR
✓	✓	✓	✓	✓	✓	✓	✓	✓	✓	✓	✓	✓	✓	✓	✓	✓	✓	✓	✓	✓	✓	✓	✓	✓

¹ Not available on 54" or 60" wide.

² Not available with 6" fluting.

³ Only available on WSL3, WSR3, and WS83.

VANITY CONSOLE DRAWER BASE with SIX DRAWERS, 34 1/2" HIGH, 21" DEEP

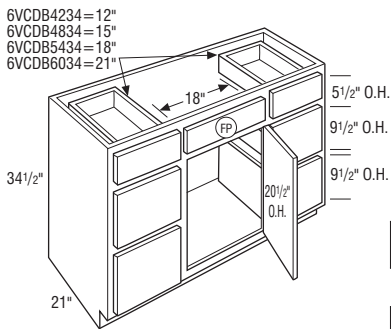

6VCDB423421 L or R	21.3	3772	3965	4095	4315	4542	4974	5406
6VCDB483421 L or R	24.2	3848	4046	4178	4409	4637	5072	5507
6VCDB543421 L or R	27.2	3972	4164	4306	4544	4782	5231	5680
6VCDB603421 L or R	30.1	4052	4245	4397	4640	4867	5330	5793

• Specify L or R hinge for center door.

FP False Panel

Door & Drawer Options

CC	CG	GAMD	HC	IFHG	MC	MD	MFO	PRMD	SGLPN	SHMD	SPLITDR	SPLITDRWS	TCG	TCP
✓	✓	✓	✓	✓	✓	✓	✓	✓	✓	✓	✓	✓	✓	✓

End Panel Options

AUTH	CSFPE	EXBK	EXDN	FFD	FL/FR	FPE	INTGE	IPE
✓	✓	✓	✓	✓	✓	✓	✓	✓

Custom Modification Options

ADD	SHLF	ADTK	ADRW	BVR	CBO	CCO	CFNTO	CFP	CFRMO	CLIP	CMAT	CND	CSDGBK ¹	DRWTK	EX	EX_OL	FD	FLUT ²	FTK	ID	IH	INVFRM	IW
✓	✓	✓	✓	✓	✓	✓	✓	✓	✓	✓	✓	✓	✓	✓	✓	✓	✓	✓	✓	✓	✓	✓	✓

MIP	OBRB	PFINBTMB	RD	REC	RECTK	RECTK ⁶	RECTKFR76	RH	ROSFLUT	RT	SBCADDY	SBCADDYSM	SCPDRW	TBN	TD	TKP	TVR	UDBX	URT	VLSO	VTK	VWB	WS ³	WTR
✓	✓	✓	✓	✓	✓	✓	✓	✓	✓	✓	✓	✓	✓	✓	✓	✓	✓	✓	✓	✓	✓	✓	✓	✓

¹ Only available on 42" and 48" wide.

² Not available with 6" fluting.

³ Only available on WSR3, WSL3, and WS83.

IH/RH availability charts starting on page G-40.
IW/RW availability charts starting on page G-46.

Vanity Console Drawer Base Cabinets

	Cubic Feet	1	2	3	4	5	6	7
VANITY CONSOLE DRAWER BASE with EIGHT DRAWERS, 32" HIGH, 21" DEEP								
4-6VCDB423221 L or R	19.8	4320	4549	4694	4960	5213	5708	6203
4-6VCDB483221 L or R	22.6	4413	4645	4790	5061	5321	5821	6321
4-6VCDB543221 L or R	25.3	4557	4782	4939	5217	5487	5998	6509
4-6VCDB603221 L or R	28.0	4650	4874	5041	5322	5589	6118	6647

- Specify L or R hinge for center door.
- Includes touch-up kit and owner's guide.

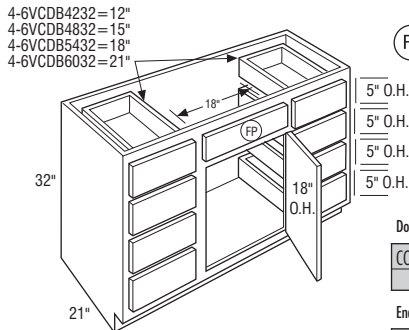

(FP) False Panel

Door & Drawer Options

CC	CG	GAMD	HC	IFHG	MC	MD	MFO	PRMD	SGLPN	SHMD	SPLITDR	SPLITDRWS	TCG	TCP
✓	✓	✓	✓	✓	✓	✓	✓	✓	✓	✓	✓	✓	✓	✓

End Panel Options

AUTH	CSFPE	EXBK	EXDN	FFD	FL/FR	FPE	INTGE	IPE
✓	✓	✓	✓	✓	✓	✓	✓	✓

Custom Modification Options

ADD	SHLF	ADDTK	ADRW	BVR	CBO	CCO	CFNTO	CFP	CFRMO	CLIP	CMAT	CND	CSDGBK ¹	DRWTK	EX	EX_OL	FD	FLUT ²	FTK	ID	IH	INVFRM	IW	
✓	✓	✓	✓	✓	✓	✓	✓	✓	✓	✓	✓	✓	✓	✓	✓	✓	✓	✓	✓	✓	✓	✓	✓	✓

MIP	OBRB	PFINBTMB	RD	REC	RECTK	RECTK_6	RECTKRT6	RH	ROSLUT	RT	SBCADDY	SBCADDYSM	SCPDRW	TBN	TD	TKP	TVR	UDBX	URT	VLSO	VTK	VWB	WS ³	WTR
✓	✓	✓	✓	✓	✓	✓	✓	✓	✓	✓	✓	✓	✓	✓	✓	✓	✓	✓	✓	✓	✓	✓	✓	✓

¹ Not available on 54" or 60" wide.

² Not available with 6" fluting.

³ Only available on WSL3, WSR3, and WS83.

VANITY CONSOLE DRAWER BASE with EIGHT DRAWERS, 34 1/2" HIGH, 21" DEEP								
4-6VCDB423421 L or R	21.3	4527	4758	4913	5179	5450	5969	6488
4-6VCDB483421 L or R	24.2	4618	4856	5013	5291	5564	6087	6610
4-6VCDB543421 L or R	27.2	4767	4997	5167	5453	5738	6276	6814
4-6VCDB603421 L or R	30.1	4863	5094	5275	5567	5841	6398	6955

- Specify L or R hinge for center door.
- Includes touch-up kit and owner's guide.

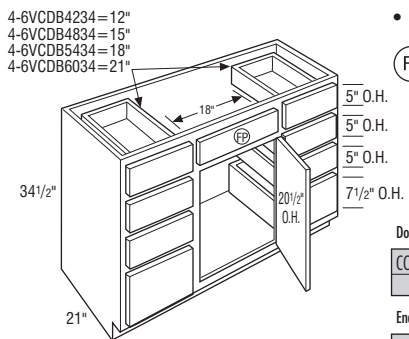

(FP) False Panel

Door & Drawer Options

CC	CG	GAMD	HC	IFHG	MC	MD	MFO	PRMD	SGLPN	SHMD	SPLITDR	SPLITDRWS	TCG	TCP
✓	✓	✓	✓	✓	✓	✓	✓	✓	✓	✓	✓	✓	✓	✓

End Panel Options

AUTH	CSFPE	EXBK	EXDN	FFD	FL/FR	FPE	INTGE	IPE
✓	✓	✓	✓	✓	✓	✓	✓	✓

Custom Modification Options

ADD	SHLF	ADDTK	ADRW	BVR	CBO	CCO	CFNTO	CFP	CFRMO	CLIP	CMAT	CND	CSDGBK ¹	DRWTK	EX	EX_OL	FD	FLUT ²	FTK	ID	IH	INVFRM	IW
✓	✓	✓	✓	✓	✓	✓	✓	✓	✓	✓	✓	✓	✓	✓	✓	✓	✓	✓	✓	✓	✓	✓	✓

MIP	OBRB	PFINBTMB	RD	REC	RECTK	RECTK_6	RECTKRT6	RH	ROSLUT	RT	SBCADDY	SBCADDYSM	SCPDRW	TBN	TD	TKP	TVR	UDBX	URT	VLSO	VTK	VWB	WS ³	WTR
✓	✓	✓	✓	✓	✓	✓	✓	✓	✓	✓	✓	✓	✓	✓	✓	✓	✓	✓	✓	✓	✓	✓	✓	✓

¹ Only available on 42" and 48" wide.

² Not available with 6" fluting.

³ Only available on WSR3, WSL3, and WS83.

Vanity Sink Drawer Base Cabinets

VANITY SINK DRAWER BASE with SIX DRAWERS, 32" HIGH, 18" or 21" DEEP

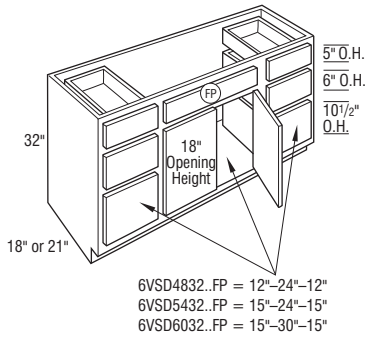
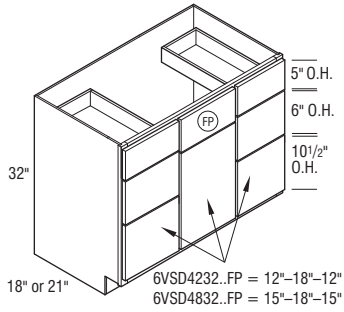

Cubic Feet	1	2	3	4	5	6	7	
6VSD423218FP L or R	16.6	3080	3223	3395	3584	3794	4132	4470
6VSD483218FP L or R	19.0	3217	3366	3545	3741	3962	4314	4666
6VSD423221FP L or R	19.8	3080	3223	3395	3584	3794	4132	4470
6VSD483221FP L or R	22.6	3217	3366	3545	3741	3962	4314	4666

• Middle door will be hinged left unless specified otherwise.

6VSD483218FP	19.0	3225	3374	3554	3750	3972	4325	4678
6VSD543218FP	21.3	3232	3382	3563	3759	3982	4335	4688
6VSD603218FP	23.6	3400	3570	3581	3673	4208	4534	4860
6VSD483221FP	22.6	3225	3374	3554	3750	3972	4325	4678
6VSD543221FP	25.3	3232	3382	3563	3759	3982	4335	4688
6VSD603221FP	28.0	3400	3570	3581	3673	4208	4534	4860

- Touch-up kit (TUK) and Owner's Guide included.
- Six total drawers.
- Increased Depths available in 1/4" increments from 21 1/4" to 24".
- Reduced Depths available in 1/4" increments from 12" to 20 3/4".

FP False Panel

Door & Drawer Options

CC	CG	GAMD	HC	IFHG	MC	MD	MFO	PRMD	SGLPN	SHMD	SPLITDR	SPLITDRWS	TCG	TCP
✓	✓	✓	✓	✓	✓	✓	✓	✓	✓	✓	✓	✓	✓	✓

End Panel Options

AUTH	CSFPE	EXBK	EXDN	FFD	FL/FR	FPE	INTGE	IPE
✓	✓	✓	✓	✓	✓	✓	✓	✓

Custom Modification Options

ADD	SHLF	ADDTK	ADRW	BVR	CBO	CCO	CFNTO	CFP	CFRMO	CLIP	CMAT ¹	CND	CSDGBK	DRWTK	EX	EX_OL	FD	FLUT ²	FTK	ID	IH	INVFRM	IW	
✓	✓	✓	✓	✓	✓	✓	✓	✓	✓	✓	✓	✓	✓	✓	✓	✓	✓	✓	✓	✓	✓	✓	✓	✓

MIP	OBRB	PFINBTMB	RD	REC	RECTK ³	RECTK ⁴	RECTK ⁶	RH	ROSLUT	RT	SBCADDY	SBCADDYSM	SCPDWR	TBN	TD	TKP ³	TVR	UDBX	URT	VLSO	VTK ³	VWB ⁵	WS ⁶	WTR
✓	✓	✓	✓	✓	✓	✓	✓	✓	✓	✓	✓	✓	✓	✓	✓	✓	✓	✓	✓	✓	✓	✓	✓	✓

- Not available with 42" or 48" wide.
- Not available with 6" fluting.
- Only available on 60" wide.
- 18" deep can not be recessed in both the front and back.
- Not available on depths less than 21".
- Wide stile 1.5" versions not available on 60" wide.

IH/RH availability charts starting on page G•40.
IW/RW availability charts starting on page G•46.

Vanity Sink Drawer Base Cabinets

VANITY SINK DRAWER BASE with SIX DRAWERS, 34 1/2" HIGH, 18" or 21" DEEP

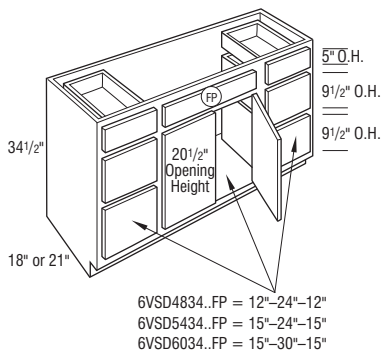
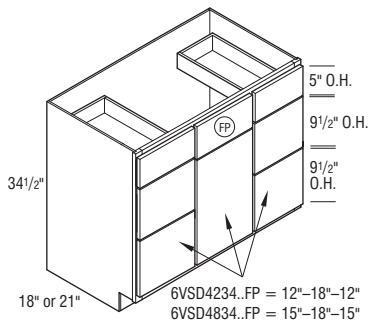

Cubic Feet	1	2	3	4	5	6	7	
6VSD423418FP L or R	17.9	3138	3285	3460	3651	3866	4210	4554
6VSD483418FP L or R	20.4	3286	3437	3622	3822	4046	4406	4766
6VSD423421FP L or R	21.3	3138	3285	3460	3651	3866	4210	4554
6VSD483421FP L or R	24.2	3286	3437	3622	3822	4046	4406	4766

• Middle door will be hinged left unless specified otherwise.

6VSD483418FP	20.4	3335	3488	3676	3879	4107	4472	4837
6VSD543418FP	22.9	3384	3539	3730	3935	4168	4538	4908
6VSD603418FP	25.4	3559	3734	3746	3839	4403	4740	5077
6VSD483421FP	24.2	3335	3488	3676	3879	4107	4472	4837
6VSD543421FP	27.2	3384	3539	3730	3935	4168	4538	4908
6VSD603421FP	30.1	3559	3734	3746	3839	4403	4740	5077

- Touch-up kit (TUK) and Owner's Guide included.
- Six total drawers.
- Increased Depths available in 1/4" increments from 21 1/4" to 24".
- Reduced Depths available in 1/4" increments from 12" to 20 3/4".

(FP) False Panel

Door & Drawer Options

CC	CG	GAMD	HC	IFHG	MC	MD	MFO	PRMD	SGLPN	SHMD	SPLITDR	SPLITDRWS	TCG	TCP
✓	✓	✓	✓	✓	✓	✓	✓	✓	✓	✓	✓	✓	✓	✓

End Panel Options

AUTH	CSFPE	EXBK	EXDN	FFD	FL/FR	FPE	INTGE	IPE
✓	✓	✓	✓	✓	✓	✓	✓	✓

Custom Modification Options

ADD_SHLF	ADDTK	ADRW	BVR	CBO	CCO	CFNTO	CFP	CFRMO	CLIP	CMAT ¹	CND	CSDGBK	DRWTK	EX	EX_OL	FD	FLUT ²	FTK ³	ID	IH	INVFRM	IW	
✓	✓	✓	✓	✓	✓	✓	✓	✓	✓	✓	✓	✓	✓	✓	✓	✓	✓	✓	✓	✓	✓	✓	✓

MIP	OBRB	PFINBTMB	RD	REC	RECTK	RECTK_6 ⁴	RECTKFT6	RH	ROSFLUT	RT	SBCADDY	SBCADDYSM	SCPDWR	TBN	TD	TKP	TVR	UBX	URT	VLSO ⁵	VTK	VWB ⁶	WS ⁷	WTR
✓	✓	✓	✓	✓	✓	✓	✓	✓	✓	✓	✓	✓	✓	✓	✓	✓	✓	✓	✓	✓	✓	✓	✓	✓

¹ Not available with 42" or 48" wide.

² Not available with 6" fluting.

³ FTKAV and style B-L not available on 60" wide.

⁴ 18" deep can not be recessed in both the front and back.

⁵ Not available on depths less than 21". VLSOB not available on 1 door version. Not available on 48" wide.

⁶ Not available on depths less than 21".

⁷ Wide stile 1.5" versions not available on 60" wide.

Vanity Sink Drawer Base Cabinets

VANITY SINK DRAWER BASE with EIGHT DRAWERS and FALSE PANEL, 32" HIGH, 18" or 21" DEEP

8VSD423221FP=12"
8VSD483221FP=15"

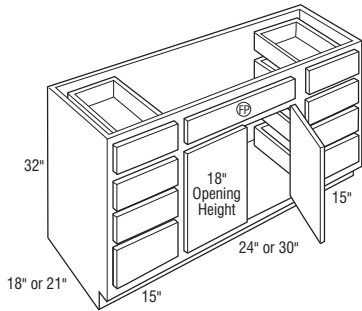
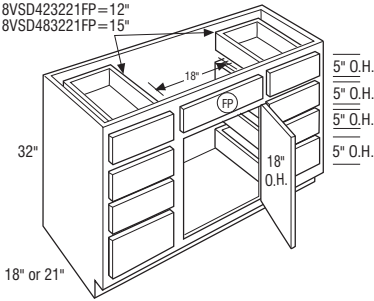

	Cubic Feet	1	2	3	4	5	6	7
8VSD423218FP L or R	16.6	3697	3868	4076	4299	4553	4958	5363
8VSD483218FP L or R	19.0	3860	4039	4254	4489	4753	5177	5601
8VSD423221FP L or R	19.8	3697	3868	4076	4299	4553	4958	5363
8VSD483221FP L or R	22.6	3860	4039	4254	4489	4753	5177	5601

• Middle door will be hinged left unless specified otherwise.

8VSD543218FP	21.3	3879	4057	4275	4510	4779	5202	5625
8VSD603218FP	23.6	4080	4283	4297	4408	5051	5441	5831
8VSD543221FP	25.3	3879	4057	4275	4510	4779	5202	5625
8VSD603221FP	28.0	4080	4283	4297	4408	5051	5441	5831

- Touch-up kit (TUK) and Owner's Guide included.
- Eight total drawers.
- Increased Depths available in 1/4" increments from 21 1/4" to 24".
- Reduced Depths available in 1/4" increments from 12" to 20 3/4".

FP False Panel

5" O.H.
5" O.H.
5" O.H.
5" O.H.

Door & Drawer Options

CC	CG	GAMD	HC	IFHG	MC	MD	MFO	PRMD	SGLPN	SHMD	SPLITDR	SPLITDRWS	TCG	TCP
✓	✓	✓	✓	✓	✓	✓	✓	✓	✓	✓	✓	✓	✓	✓

End Panel Options

AUTH	CSFPE	EXBK	EXDN	FFD	FL/FR	FPE	INTGE	IPE
✓	✓	✓	✓	✓	✓	✓	✓	✓

Custom Modification Options

ADD	SHLF	ADTK	ADRW	BVR	CBO	CCO	CFNT0	CFP	CFRMO	CLIP	CMAT ¹	CND	CSDGBK	DRWTK	EX	EX_OL	FD	FLUT	FTK	ID	IH	INVFRM	IW
✓	✓	✓	✓	✓	✓	✓	✓	✓	✓	✓	✓	✓	✓	✓	✓	✓	✓	✓	✓	✓	✓	✓	✓

MIP	OBRB	PFINBTMB	RD	REC	RECTK	RECTK ²	RECTK ² RT6	RH	ROSLUT	RT	SBCADDY	SBCADDYSM	SCPDRW	TBN	TD	TKP	TVR	UDBX	URT	VLSO	VTK	VWB ³	WS	WTR
✓	✓	✓	✓	✓	✓	✓	✓	✓	✓	✓	✓	✓	✓	✓	✓	✓	✓	✓	✓	✓	✓	✓	✓	✓

¹ Not available on 42"-48" wide.

² 18" deep can not be recessed in both the front and back.

³ Not available on depths less than 21".

IH/RH availability charts starting on page G-40.
IW/RW availability charts starting on page G-46.

Vanity Sink Drawer Base Cabinets

VANITY SINK DRAWER BASE with EIGHT DRAWERS and FALSE PANEL, 34 1/2" HIGH, 18" or 21" DEEP

8VSD423421FP=12"
8VSD483421FP=15"

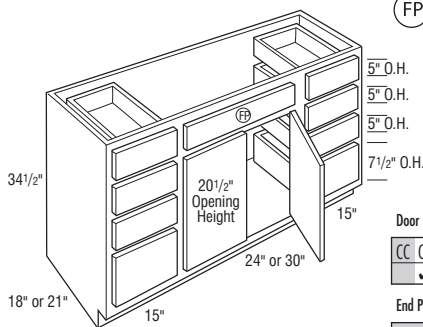
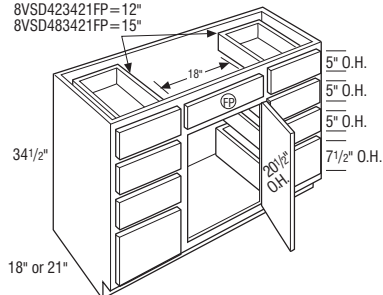

Cubic Feet	1	2	3	4	5	6	7
8VSD423418FP L or R	17.9	3767	3941	4152	4382	4639	5465
8VSD483418FP L or R	20.4	3943	4125	4345	4586	4856	5722
8VSD423421FP L or R	21.3	3767	3941	4152	4382	4639	5465
8VSD483421FP L or R	24.2	3943	4125	4345	4586	4856	5722
8VSD543418FP	22.9	4062	4247	4477	4723	5001	5891
8VSD603418FP	25.4	4270	4480	4495	4607	5284	6092
8VSD543421FP	27.2	4062	4247	4477	4723	5001	5891
8VSD603421FP	30.1	4270	4480	4495	4607	5284	6092

• Middle door will be hinged left unless specified otherwise.

- Touch-up kit (TUK) and Owner's Guide included.
- Eight total drawers.
- Increased Depths available in 1/4" increments from 21 1/4" to 24".
- Reduced Depths available in 1/4" increments from 12" to 20 3/4".

FP False Panel

Door & Drawer Options

CC	CG	GAMD	HC	IFHG	MC	MD	MFO	PRMD	SGLPN	SHMD	SPLITDR	SPLITDRWS	TCG	TCP
✓	✓	✓	✓	✓	✓	✓	✓	✓	✓	✓				

End Panel Options

AUTH	CSFPE	EXBK	EXDN	FFD	FL/FR	FPE	INTGE	IPE
✓	✓	✓	✓	✓	✓	✓	✓	✓

Custom Modification Options

ADD	SHLF	ADDTK	ADRW	BVR	CBO	CCO	CFNTO	CFP	CFRMO	CLIP	CMAT ¹	CND	CSDGBK	DRWTK	EX	EX_OL	FD	FLUT	FTK	ID	IH	INVFRM	IW	
						✓	✓	✓	✓	✓	✓	✓	✓		✓	✓	✓	✓	✓	✓	✓	✓	✓	✓

MIP	OBRB	PFINBTMB	RD	REC	RECTK	RECTK_6 ²	RECTKERT6	RH	ROSLUT	RT	SBCADDY	SBCADDYSM	SCPDWR	TBN	TD	TKP	TVR	UDBX	URT	VLSO	VTK	VWB ³	WS	WTR
✓	✓	✓	✓	✓	✓	✓	✓	✓	✓	✓	✓	✓	✓	✓	✓	✓	✓	✓	✓	✓	✓	✓	✓	✓

¹ Not available on 42"-48" wide.

² 18" deep can not be recessed in both the front and back.

³ Not available on depths less than 21".

Vanity Console Drawer Base Cabinets

VANITY CONSOLE DRAWER BASE with SIX DRAWERS and WOOD TIERED VANITY DRAWER, 32" HIGH, 21" DEEP

L O G I X

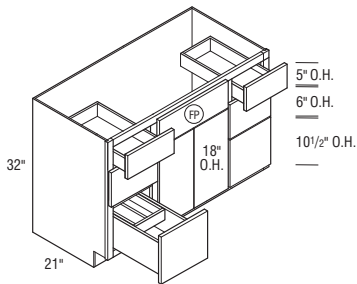
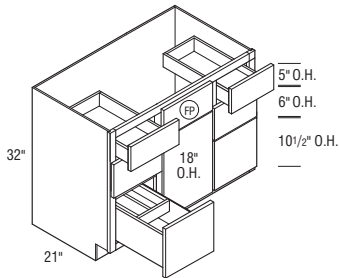

	Cubic Feet	1	2	3	4	5	6	7
6VSDB423221WTV L or R	18.6	4197	4368	4576	4799	5053	5458	5863
6VSDB483221WTV L or R	21.2	4360	4539	4754	4989	5253	5677	6101
6VSDB543221WTV	23.8	4379	4557	4775	5010	5279	5702	6125
6VSDB603221WTV	26.3	4580	4783	4797	4908	5551	5941	6331

• Middle door will be hinged left unless specified otherwise.

- Touch-up kit (TUK) and Owner's Guide included.
- Six total drawers.
- Includes Wood Tiered Vanity Drawer.
- Wood Tiered Vanity Drawer will be installed in the left side of the cabinet.
- Wood Tiered Vanity Drawer is also available as an accessory for field installation. See page S•5.
- Exterior Wood Tiered Vanity drawer box height is 7 1/2", interior height of top tier is 2 1/4", and interior height of bottom tier is 4 1/4".

FP False Panel

Door & Drawer Options

CC	CG	GAMD	HC	IFHG	MC	MD	MFO	PRMD	SGLPN	SHMD	SPLITDR	SPLITDRWS	TCG	TCP
✓	✓	✓	✓	✓	✓	✓	✓	✓	✓	✓	✓	✓	✓	✓

End Panel Options

AUTH	CSFPE	EXBK	EXDN	FFD	FL/FR	FPE	INTGE	IPE
✓	✓	✓	✓	✓	✓	✓	✓	✓

Custom Modification Options

ADD	SHLF	ADDTK	ADRW	BVR	CBO	CCO	CFNTD	CFP	CFRMO	CLIP	CMAT ¹	CND	CSDGBK	DRWTK	EX	EX_OL	FD	FLUT ²	FTK ³	ID	IH	INVERM	IW	
✓	✓	✓	✓	✓	✓	✓	✓	✓	✓	✓	✓	✓	✓	✓	✓	✓	✓	✓	✓	✓	✓	✓	✓	✓
MIP	OBRB	PFINBTMB	RD	REC	RECTK	RECTK_6	RECTKFRT6	RH	ROSFLUT ²	RT	SBCADDY	SBCADDYSM	SCPDRW	TBN	TD	TKP	TVR	UDBX	URT	VLSO	VTK	VWB	WS ⁴	WTR
✓	✓	✓	✓	✓	✓	✓	✓	✓	✓	✓	✓	✓	✓	✓	✓	✓	✓	✓	✓	✓	✓	✓	✓	✓

¹ Only available on 54" and 60" wide.

² Not available with 6" fluting.

³ FTKAV and style B-L not available on 60" wide.

⁴ Wide stile 1.5 not available on 60" wide.

VANITY CONSOLE DRAWER BASE with SIX DRAWERS and WOOD TIERED VANITY DRAWER, 34 1/2" HIGH, 21" DEEP

L O G I X

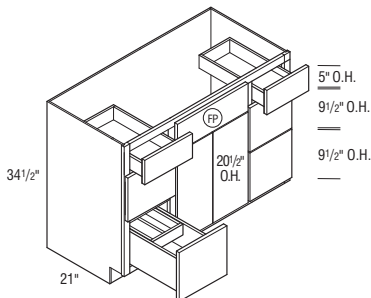
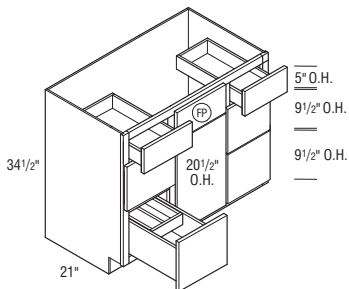

	Cubic Feet	1	2	3	4	5	6	7
6VSDB423421WTV L or R	18.6	4267	4441	4652	4882	5139	5552	5965
6VSDB483421WTV L or R	21.2	4443	4625	4845	5086	5356	5789	6222
6VSDB543421WTV	23.8	4562	4747	4977	5223	5501	5946	6391
6VSDB603421WTV	26.3	4770	4980	4995	5107	5784	6188	6592

• Middle door will be hinged left unless specified otherwise.

- Touch-up kit (TUK) and Owner's Guide included.
- Six total drawers.
- Includes Wood Tiered Vanity Drawer.
- Wood Tiered Vanity Drawer will be installed in the left side of the cabinet.
- Wood Tiered Vanity Drawer is also available as an accessory for field installation. See page S•5.
- Exterior Wood Tiered Vanity drawer box height is 7 1/2", interior height of top tier is 2 1/4", and interior height of bottom tier is 4 1/4".

FP False Panel

Door & Drawer Options

CC	CG	GAMD	HC	IFHG	MC	MD	MFO	PRMD	SGLPN	SHMD	SPLITDR	SPLITDRWS	TCG	TCP
✓	✓	✓	✓	✓	✓	✓	✓	✓	✓	✓	✓	✓	✓	✓

End Panel Options

AUTH	CSFPE	EXBK	EXDN	FFD	FL/FR	FPE	INTGE	IPE
✓	✓	✓	✓	✓	✓	✓	✓	✓

Custom Modification Options

ADD	SHLF	ADDTK	ADRW	BVR	CBO	CCO	CFNTD	CFP	CFRMO	CLIP	CMAT ¹	CND	CSDGBK	DRWTK	EX	EX_OL	FD	FLUT ²	FTK	ID	IH	INVERM	IW	
✓	✓	✓	✓	✓	✓	✓	✓	✓	✓	✓	✓	✓	✓	✓	✓	✓	✓	✓	✓	✓	✓	✓	✓	✓
MIP	OBRB	PFINBTMB	RD	REC	RECTK	RECTK_6	RECTKFRT6	RH	ROSFLUT ²	RT	SBCADDY	SBCADDYSM	SCPDRW	TBN	TD	TKP	TVR	UDBX	URT	VLSO	VTK	VWB	WS ³	WTR
✓	✓	✓	✓	✓	✓	✓	✓	✓	✓	✓	✓	✓	✓	✓	✓	✓	✓	✓	✓	✓	✓	✓	✓	✓

¹ Only available on 54" and 60" wide.

² Not available with 6" fluting.

³ Wide stile 1.5 not available on 60" wide.

IH/RH availability charts starting on page G•40.
IW/RW availability charts starting on page G•46.

Double Vanity Sink Base Cabinets

DOUBLE VANITY SINK BASE, 32" HIGH, 21" DEEP

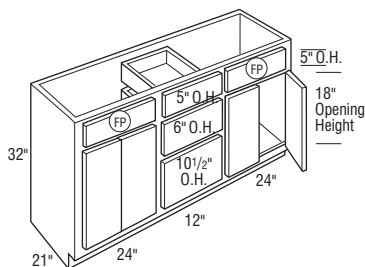

VSBD603221

Cubic Feet	1	2	3	4	5	6	7
	28.0	2991	3134	3240	3417	3607	4281

- Touch-up kit (TUK) and Owner's Guide included.
- Increased Depths available in 1/4" increments from 21 1/4" to 24".
- Reduced Depths available in 1/4" increments from 12" to 20 3/4".

(FP) False Panel

Door & Drawer Options

CC	CG	GAMD	HC	IFHG	MC	MD	MFO	PRMD	SGLPN	SHMD	SPLITDR	SPLITDRWS	TCG	TCP
✓	✓	✓	✓	✓	✓	✓	✓	✓	✓	✓	✓	✓	✓	✓

End Panel Options

AUTH	CSFPE	EXBK	EXDN	FFD	FL/FR	FPE	INTGE	IPE
✓	✓	✓	✓	✓	✓	✓	✓	✓

Custom Modification Options

ADD_SHLF	ADDTK	ADRW	BVR	CBO	CCO	CFNTO	CFP	CFRMO	CLIP	CMAT	CND	CSDGBK	DRWTK	EX	EX_OL	FD	FLUT ¹	FTK	ID	IH	INVFRM	IW	
✓	✓	✓	✓	✓	✓	✓	✓	✓	✓	✓	✓	✓	✓	✓	✓	✓	✓	✓	✓	✓	✓	✓	✓

MIP	OBRB	PFINBTMB	RD	REC	RECTK	RECTK_6	RECTKFR6	RH	ROSLUT	RT	SBCADDY	SBCADDYSM	SCPDRW	TBN	TD	TKP	TVR	UDBX	URT	VLSO	VTK	VWB	WS	WTR
✓	✓	✓	✓	✓	✓	✓	✓	✓	✓	✓	✓	✓	✓	✓	✓	✓	✓	✓	✓	✓	✓	✓	✓	✓

¹ Not available with 6" fluting.

DOUBLE VANITY SINK BASE, 34 1/2" HIGH, 21" DEEP

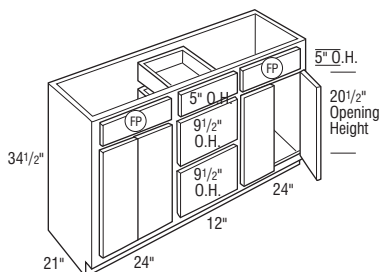

VSBD603421

Cubic Feet	1	2	3	4	5	6	7
	30.1	3127	3277	3389	3572	3774	4468

- Touch-up kit (TUK) and Owner's Guide included.
- Increased Depths available in 1/4" increments from 21 1/4" to 24".
- Reduced Depths available in 1/4" increments from 12" to 20 3/4".

(FP) False Panel

Door & Drawer Options

CC	CG	GAMD	HC	IFHG	MC	MD	MFO	PRMD	SGLPN	SHMD	SPLITDR	SPLITDRWS	TCG	TCP
✓	✓	✓	✓	✓	✓	✓	✓	✓	✓	✓	✓	✓	✓	✓

End Panel Options

AUTH	CSFPE	EXBK	EXDN	FFD	FL/FR	FPE	INTGE	IPE
✓	✓	✓	✓	✓	✓	✓	✓	✓

Custom Modification Options

ADD_SHLF	ADDTK	ADRW	BVR	CBO	CCO	CFNTO	CFP	CFRMO	CLIP	CMAT	CND	CSDGBK	DRWTK	EX	EX_OL	FD	FLUT ¹	FTK	ID	IH	INVFRM	IW	
✓	✓	✓	✓	✓	✓	✓	✓	✓	✓	✓	✓	✓	✓	✓	✓	✓	✓	✓	✓	✓	✓	✓	✓

MIP	OBRB	PFINBTMB	RD	REC	RECTK	RECTK_6	RECTKFR6	RH	ROSLUT	RT	SBCADDY	SBCADDYSM	SCPDRW	TBN	TD	TKP	TVR	UDBX	URT	VLSO	VTK	VWB	WS	WTR
✓	✓	✓	✓	✓	✓	✓	✓	✓	✓	✓	✓	✓	✓	✓	✓	✓	✓	✓	✓	✓	✓	✓	✓	✓

¹ Not available with 6" fluting.

DOUBLE VANITY SINK BASE with FOUR DRAWERS, 32" HIGH, 21" DEEP

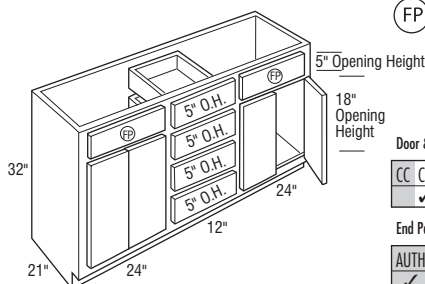

4VSD603221

Cubic Feet	1	2	3	4	5	6	7
	28.0	3588	3762	3889	4100	4328	5140

- Touch-up kit (TUK) and Owner's Guide included.
- Increased Depths available in 1/4" increments from 21 1/4" to 24".
- Reduced Depths available in 1/4" increments from 12" to 20 3/4".

(FP) False Panel

Door & Drawer Options

CC	CG	GAMD	HC	IFHG	MC	MD	MFO	PRMD	SGLPN	SHMD	SPLITDR	SPLITDRWS	TCG	TCP
✓	✓	✓	✓	✓	✓	✓	✓	✓	✓	✓	✓	✓	✓	✓

End Panel Options

AUTH	CSFPE	EXBK	EXDN	FFD	FL/FR	FPE	INTGE	IPE
✓	✓	✓	✓	✓	✓	✓	✓	✓

Custom Modification Options

ADD_SHLF	ADDTK	ADRW	BVR	CBO	CCO	CFNTO	CFP	CFRMO	CLIP	CMAT	CND	CSDGBK	DRWTK	EX	EX_OL	FD	FLUT ¹	FTK	ID	IH	INVFRM	IW	
✓	✓	✓	✓	✓	✓	✓	✓	✓	✓	✓	✓	✓	✓	✓	✓	✓	✓	✓	✓	✓	✓	✓	✓

MIP	OBRB	PFINBTMB	RD	REC	RECTK	RECTK_6	RECTKFR6	RH	ROSLUT	RT	SBCADDY	SBCADDYSM	SCPDRW	TBN	TD	TKP	TVR	UDBX	URT	VLSO	VTK	VWB	WS	WTR
✓	✓	✓	✓	✓	✓	✓	✓	✓	✓	✓	✓	✓	✓	✓	✓	✓	✓	✓	✓	✓	✓	✓	✓	✓

Double Vanity Sink Base & Vanity Hamper Base Cabinets

	Cubic Feet	1	2	3	4	5	6	7	
DOUBLE VANITY SINK BASE with FOUR DRAWERS, 34 1/2" HIGH, 21" DEEP	4VSD603421	30.1	3752	3933	4068	4287	4530	4945	5360

- Touch-up kit (TUK) and Owner's Guide included.
- Increased Depths available in 1/4" increments from 21 1/4" to 24".
- Reduced Depths available in 1/4" increments from 12" to 20 3/4".

FP False Panel

5" Opening Height
20 1/2" Opening Height

34 1/2"
21"
24"

5" O.H.
5" O.H.
5" O.H.
7 1/2" O.H.

12" 24"

Door & Drawer Options

CC	CG	GAMD	HC	IFHG	MC	MD	MFO	PRMD	SGLPN	SHMD	SPLITDR	SPLITDRWS	TCG	TCP
✓	✓	✓	✓	✓	✓	✓	✓	✓	✓	✓	✓	✓	✓	✓

End Panel Options

AUTH	CSFPE	EXBK	EXDN	FFD	FL/FR	FPE	INTGE	IPE
✓	✓	✓	✓	✓	✓	✓	✓	✓

Custom Modification Options

ADD	SHLF	ADDTK	ADRW	BVR	CBO	CCO	CFNT0	CFP	CFRMO	CLIP	CMAT	CND	CSDGBK	DRWTK	EX	EX_OL	FD	FLUT	FTK	ID	IH	INVFRM	IW	
✓	✓	✓	✓	✓	✓	✓	✓	✓	✓	✓	✓	✓	✓	✓	✓	✓	✓	✓	✓	✓	✓	✓	✓	✓

MIP	OBRB	PFINBTMB	RD	REC	RECTK	RECTK_6	RECTKRT6	RH	ROSLUT	RT	SBCADDY	SBCADDYSM	SCPDRW	TBN	TD	TKP	TVR	UDBX	URT	VLSO	VTK	VWB	WS	WTR	
✓	✓	✓	✓	✓	✓	✓	✓	✓	✓	✓	✓	✓	✓	✓	✓	✓	✓	✓	✓	✓	✓	✓	✓	✓	✓

VANITY HAMPER BASE CABINET, 32" or 34 1/2" HIGH, 21" DEEP	VH183221FH L or R	8.9	1997	2051	2090	2163	2238	2373	2508
	VH183421FH L or R	9.5	2048	2109	2150	2224	2304	2444	2584

- Hamper utilizes floor mounted glides.
- Hamper size is 14 9/16" W x 18 15/16" H x 17 23/32" D.
- Chrome basket with creme linen liner.
- Increased Depths available in 1/4" increments from 21 1/4" to 30".
- Only available in Inset and Beaded Inset when used in conjunction with a finial hinge.

Door & Drawer Options

CC	CG	GAMD	HC	IFHG	MC	MD	MFO	PRMD	SGLPN	SHMD	SPLITDR	SPLITDRWS	TCG	TCP
✓	✓	✓	✓	✓	✓	✓	✓	✓	✓	✓	✓	✓	✓	✓

End Panel Options

AUTH	CSFPE	EXBK	EXDN	FFD	FL/FR	FPE	INTGE	IPE
✓	✓	✓	✓	✓	✓	✓	✓	✓

Custom Modification Options

ADD	SHLF	ADDTK	ADRW	BVR	CBO	CCO	CFNT0	CFP	CFRMO	CLIP	CMAT	CND	CSDGBK	DRWTK	EX	EX_OL	FD	FLUT	FTK	ID	IH	INVFRM	IW	
✓	✓	✓	✓	✓	✓	✓	✓	✓	✓	✓	✓	✓	✓	✓	✓	✓	✓	✓	✓	✓	✓	✓	✓	✓

MIP	OBRB	PFINBTMB	RD	REC	RECTK	RECTK_6 ²	RECTKRT6	RH	ROSLUT	RT	SBCADDY	SBCADDYSM	SCPDRW	TBN	TD	TKP	TVR	UDBX	URT	VLSO	VTK	VWB	WS	WTR	
✓	✓	✓	✓	✓	✓	✓	✓	✓	✓	✓	✓	✓	✓	✓	✓	✓	✓	✓	✓	✓	✓	✓	✓	✓	✓

¹ Not available with 6" fluting.
² Can only be recessed in the front, back, and/or one side only.

32" or 34 1/2"
21"
24 1/2" or 27" Opening Height

IH/RH availability charts starting on page G•40.
IW/RW availability charts starting on page G•46.

Vanity Sink and Hamper Drawer Base Cabinets

	Cubic Feet	1	2	3	4	5	6	7	
VANITY SINK and HAMPER DRAWER BASE, 32" HIGH, 21" DEEP	VSHDB543221D L or R	25.3	3998	4157	4266	4458	4645	5002	5359

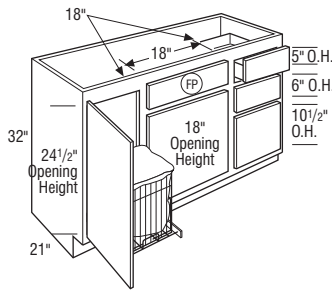

- Middle door hinged same side as drawer stack unless specified otherwise.
- Hamper utilizes floor mounted glides.
- Hamper size is 14 9/16" W x 18 15/16" H x 17 23/32" D.
- Chrome basket with creme linen liner.
- Touch-up kit (TUK) and Owner's Guide included.
- Increased Depths available in 1/4" increments from 21 1/4" to 24".
- Only available in Inset and Beaded Inset when used in conjunction with a finial hinge.

(FP) False Panel

Door & Drawer Options

CC	CG	GAMD	HC	IFHG	MC	MD	MFO	PRMD	SGLPN	SHMD	SPLITDR	SPLITDRWS	TCG	TCP
✓	✓	✓	✓	✓	✓	✓	✓	✓	✓	✓	✓	✓	✓	✓

End Panel Options

AUTH	CSFPE	EXBK	EXDN	FFD	FL/FR	FPE	INTGE	IPE
✓	✓	✓	✓	✓	✓	✓	✓	✓

Custom Modification Options

ADD_SHLF	ADDTK	ADRW	BVR	CBO	CCO	CFNTO	CFP	CFRMO	CLIP	CMAT	CND	CSDGBK	DRWTK	EX	EX_OL	FD	FLUT ¹	FTK	ID	IH	INFRM	IW	
				✓	✓	✓	✓	✓	✓	✓	✓	✓		✓	✓	✓	✓	✓	✓	✓	✓	✓	✓

MIP	OBRB	PFINBTMB	RD	REC	RECTK	RECTK_6	RECTKRT6	RH	ROSFLUT	RT	SBCADDDY	SBCADDYSM	SCPDRW	TBN	TD	TKP	TVR	UDBX	URT	VLSO	VTK	VWB	WS ²	WTR
✓	✓	✓	✓	✓	✓	✓	✓	✓	✓	✓	✓	✓	✓	✓	✓	✓	✓	✓	✓	✓	✓	✓	✓	✓

¹ Not available with 6" fluting.
² Not available with wide stile both.

	Cubic Feet	1	2	3	4	5	6	7	
VANITY SINK and HAMPER DRAWER BASE, 34 1/2" HIGH, 21" DEEP	VSHDB543421D L or R	27.2	4146	4307	4427	4627	4822	5195	5568

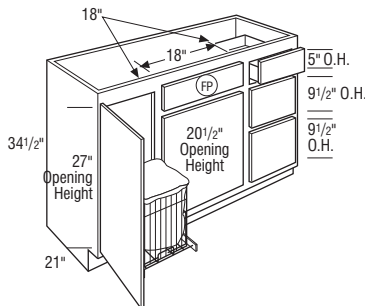

- Middle door hinged same side as drawer stack unless specified otherwise.
- Hamper utilizes floor mounted glides.
- Hamper size is 14 9/16" W x 18 15/16" H x 17 23/32" D.
- Chrome basket with creme linen liner.
- Touch-up kit (TUK) and Owner's Guide included.
- Increased Depths available in 1/4" increments from 21 1/4" to 24".
- Only available in Inset and Beaded Inset when used in conjunction with a finial hinge.

(FP) False Panel

Door & Drawer Options

CC	CG	GAMD	HC	IFHG	MC	MD	MFO	PRMD	SGLPN	SHMD	SPLITDR	SPLITDRWS	TCG	TCP
✓	✓	✓	✓	✓	✓	✓	✓	✓	✓	✓	✓	✓	✓	✓

End Panel Options

AUTH	CSFPE	EXBK	EXDN	FFD	FL/FR	FPE	INTGE	IPE
✓	✓	✓	✓	✓	✓	✓	✓	✓

Custom Modification Options

ADD_SHLF	ADDTK	ADRW	BVR	CBO	CCO	CFNTO	CFP	CFRMO	CLIP	CMAT	CND	CSDGBK	DRWTK	EX	EX_OL	FD	FLUT ¹	FTK	ID	IH	INFRM	IW	
				✓	✓	✓	✓	✓	✓	✓	✓	✓		✓	✓	✓	✓	✓	✓	✓	✓	✓	✓

MIP	OBRB	PFINBTMB	RD	REC	RECTK	RECTK_6	RECTKRT6	RH	ROSFLUT	RT	SBCADDDY	SBCADDYSM	SCPDRW	TBN	TD	TKP	TVR	UDBX	URT	VLSO	VTK	VWB	WS ²	WTR
✓	✓	✓	✓	✓	✓	✓	✓	✓	✓	✓	✓	✓	✓	✓	✓	✓	✓	✓	✓	✓	✓	✓	✓	✓

¹ Not available with 6" fluting.
² Not available with wide stile both.

Vanity Sink and Hamper Drawer Base Cabinets

VANITY SINK and HAMPER DRAWER BASE with FOUR DRAWERS, 32" HIGH, 21" DEEP

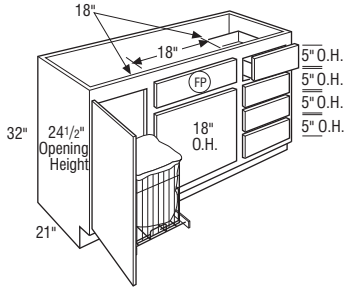

Cubic Feet	1	2	3	4	5	6	7	
4VSHDB543221D L or R	25.3	4798	4988	5120	5350	5575	6002	6429

- Middle door hinged same side as drawer stack unless specified otherwise.
- Hamper utilizes floor mounted glides.
- Hamper size is 14 9/16" W x 18 15/16" H x 17 23/32" D.
- Chrome basket with creme linen liner.
- Touch-up kit (TUK) and Owner's Guide included.
- Increased Depths available in 1/4" increments from 21 1/4" to 24".
- Only available in Inset and Beaded Inset when used in conjunction with a finial hinge.

FP False Panel

Door & Drawer Options

CC	CG	GAMD	HC	IFHG	MC	MD	MFO	PRMD	SGLPN	SHMD	SPLITDR	SPLITDRWS	TCG	TCP
✓	✓	✓	✓	✓	✓	✓	✓	✓	✓	✓	✓	✓	✓	✓

End Panel Options

AUTH	CSFPE	EXBK	EXDN	FFD	FL/FR	FPE	INTGE	IPE
✓	✓	✓	✓	✓	✓	✓	✓	✓

Custom Modification Options

ADD	SHLF	ADTK	ADRW	BVR	CBO	CCO	CFNT0	CFP	CFRMO	CLIP	CMAT	CND	CSDGBK	DRWTK	EX	EX_OL	FD	FLUT ¹	FTK	ID	IH	INVFRM	IW	
✓	✓	✓	✓	✓	✓	✓	✓	✓	✓	✓	✓	✓	✓	✓	✓	✓	✓	✓	✓	✓	✓	✓	✓	✓

MIP	OBRB	PFINBTMB	RD	REC	RECTK	RECTK_6	RECTKFR76	RH	ROSLUT	RT	SBCADDY	SBCADDYSM	SCPRDW	TBN	TD	TKP	TVR	UDBX	URT	VLSO	VTK	VWB	WS ²	WTR	
✓	✓	✓	✓	✓	✓	✓	✓	✓	✓	✓	✓	✓	✓	✓	✓	✓	✓	✓	✓	✓	✓	✓	✓	✓	✓

¹ Not available with 6" fluting.

² Not available with wide stile both.

VANITY SINK and HAMPER DRAWER BASE with FOUR DRAWERS, 34 1/2" HIGH, 21" DEEP

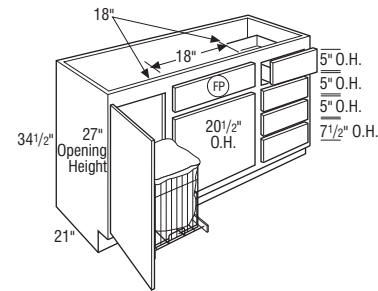

Cubic Feet	1	2	3	4	5	6	7	
4VSHDB543421D L or R	27.2	4976	5168	5312	5552	5787	6235	6683

- Middle door hinged same side as drawer stack unless specified otherwise.
- Hamper utilizes floor mounted glides.
- Hamper size is 14 9/16" W x 18 15/16" H x 17 23/32" D.
- Chrome basket with creme linen liner.
- Touch-up kit (TUK) and Owner's Guide included.
- Increased Depths available in 1/4" increments from 21 1/4" to 24".
- Only available in Inset and Beaded Inset when used in conjunction with a finial hinge.

FP False Panel

Door & Drawer Options

CC	CG	GAMD	HC	IFHG	MC	MD	MFO	PRMD	SGLPN	SHMD	SPLITDR	SPLITDRWS	TCG	TCP
✓	✓	✓	✓	✓	✓	✓	✓	✓	✓	✓	✓	✓	✓	✓

End Panel Options

AUTH	CSFPE	EXBK	EXDN	FFD	FL/FR	FPE	INTGE	IPE
✓	✓	✓	✓	✓	✓	✓	✓	✓

Custom Modification Options

ADD	SHLF	ADTK	ADRW	BVR	CBO	CCO	CFNT0	CFP	CFRMO	CLIP	CMAT	CND	CSDGBK	DRWTK	EX	EX_OL	FD	FLUT ¹	FTK	ID	IH	INVFRM	IW	
✓	✓	✓	✓	✓	✓	✓	✓	✓	✓	✓	✓	✓	✓	✓	✓	✓	✓	✓	✓	✓	✓	✓	✓	✓

MIP	OBRB	PFINBTMB	RD	REC	RECTK	RECTK_6	RECTKFR76	RH	ROSLUT	RT	SBCADDY	SBCADDYSM	SCPRDW	TBN	TD	TKP	TVR	UDBX	URT	VLSO	VTK	VWB	WS ²	WTR	
✓	✓	✓	✓	✓	✓	✓	✓	✓	✓	✓	✓	✓	✓	✓	✓	✓	✓	✓	✓	✓	✓	✓	✓	✓	✓

¹ Not available with 6" fluting.

² Not available with wide stile both.

IH/RH availability charts starting on page G-40.
IW/RW availability charts starting on page G-46.

VANITY SINK FRONT, 32" or 34 1/2" HIGH, 4 5/8" DEEP

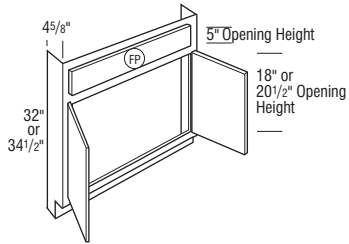
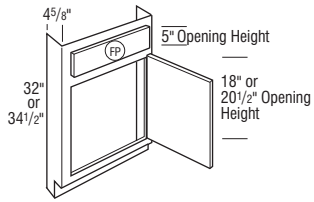

	Cubic Feet	1	2	3	4	5	6	7
VSF2432 L or R	3.5	914	953	993	1046	1099	1202	1305
VSF2434 L or R	3.8	956	998	1037	1096	1145	1256	1367
VSF3032	4.4	1324	1389	1441	1519	1584	1731	1878
VSF3632	5.2	1389	1457	1505	1583	1673	1828	1983
VSF3034	4.7	1388	1452	1506	1584	1660	1808	1956
VSF3634	5.6	1452	1524	1576	1656	1749	1915	2081

Notes below apply to all products in section above:

- Bottom included.

(FP) False Panel

Door & Drawer Options

CC	CG	GAMD	HC	IFHG	MC	MD	MFO	PRMD	SGLPN	SHMD	SPLITDR ¹	SPLITDRWS	TCG	TCP
✓	✓		✓	✓	✓		✓	✓	✓	✓	✓			

End Panel Options

AUTH	CSFPE	EXBK	EXDN	FFD	FL/FR	FPE	INTGE	IPE

Custom Modification Options

ADD	SHLF	ADDTK	ADRW	BVR	CBO ¹	CCO ¹	CFNTO	CFP	CFRMO	CLIP	CMAT	CND	CSDGBK	DRWTK	EX	EX_OL	FD	FLUT ²	FTK	ID	IH	INVFRM ¹	IW
					✓	✓						✓			✓	✓		✓	✓	✓		✓	✓

MIP	OBRB	PFINBTMB	RD	REC	RECTK	RECTK_6	RECTKRT6	RH	ROSFLUT	RT	SBCADDY	SBCADDYSM	SCPDRW	TBN	TD	TKP	TVR	UDBX	URT	VLSO	VTK	VWB	WS	WTR
✓	✓									✓								✓					✓	✓

¹ Not available on 24" wide.

² Not available with 6" fluting.

Vanity Drawer Base Cabinets

VANITY THREE DRAWER BASE, 32" HIGH, 18" or 21" DEEP

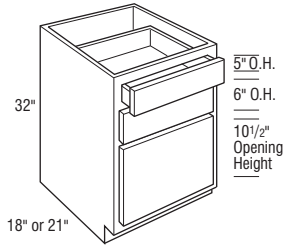

	Cubic Feet	1	2	3	4	5	6	7
VDB123218	5.1	1247	1306	1348	1407	1599	1754	1909
VDB153218	6.2	1367	1421	1473	1536	1754	1913	2072
VDB183218	7.4	1444	1525	1591	1652	1855	2059	2263
VDB213218	8.5	1567	1640	1690	1759	2013	2192	2371
VDB243218	9.7	1631	1704	1770	1854	2086	2296	2506
VDB273218	10.9	2142	2239	2325	2436	2741	3020	3299
VDB303218	12.0	2268	2367	2457	2574	2897	3187	3477
VDB333218	13.2	2325	2421	2519	2640	2971	3271	3571
VDB363218	14.3	2379	2479	2581	2700	3043	3351	3659
VDB123221	6.2	1247	1306	1348	1407	1599	1754	1909
VDB153221	7.5	1367	1421	1473	1536	1754	1913	2072
VDB183221	8.9	1444	1525	1591	1652	1855	2059	2263
VDB213221	10.3	1567	1640	1690	1759	2013	2192	2371
VDB243221	11.6	1631	1704	1770	1854	2086	2296	2506
VDB273221	13.0	2142	2239	2325	2436	2741	3020	3299
VDB303221	14.4	2268	2367	2457	2574	2897	3187	3477
VDB333221	15.7	2325	2421	2519	2640	2971	3271	3571
VDB363221	17.1	2379	2479	2581	2700	3043	3351	3659

- Increased Depths available in 1/4" increments from 21 1/4" to 24".
- Reduced Depths available in 1/4" increments from 12" to 20 3/4".

Door & Drawer Options

CC	CG	GAMD	HC	IFHG	MC	MD	MFO	PRMD	SGLPN	SHMD	SPLITDR	SPLITDRWS	TCG	TCP

End Panel Options

AUTH	CSFPE	EXBK	EXDN	FFD	FL/FR	FPE	INTGE	IPE
✓	✓	✓	✓	✓	✓	✓	✓	✓

Custom Modification Options

ADD	SHLF	ADDTK	ADRW	BVR	CBO	CCO	CFNT0	CFP	CFRMO	CLIP ¹	CMAT	CND	CSDGBK	DRWTK ²	EX	EX_OL	FD	FLUT ³	FTK ⁴	ID	IH	INVFRM	IW ⁵	
					✓	✓	✓	✓	✓	✓	✓	✓	✓	✓	✓	✓	✓	✓	✓	✓	✓	✓	✓	✓

MIP	OBRB	PFINBTMB	RD	REC	RECTK	RECTK ⁶	RECTKRT6	RH	ROSFLOT	RT	SBCADDY	SBCADDYSM	SCPDRW	TBN	TD	TKP	TVR	UDBX ²	URT	VLSO	VTK	VWB	WS	WTR
✓	✓	✓	✓	✓	✓	✓	✓	✓	✓	✓	✓	✓	✓	✓	✓	✓	✓	✓	✓	✓	✓	✓	✓	✓

¹ Not available on 12" wide.

² Not available on 12"-21" wide.

³ 6" Fluting not available on 12" or 15" wide. Fluting both 6" only available on 24"-36" wide.

⁴ FTKAV and style B-L not available on 12" wide.

⁵ Not available on 36" wide.

⁶ 12" wide can only be recessed in front and/or back. 15" and 18" wide can only be recessed in the front, back, and/or one side only. 18" deep can not be recessed in both the front and back.

IH/RH availability charts starting on page G•40.
IW/RW availability charts starting on page G•46.

Vanity Drawer Base Cabinets

VANITY THREE DRAWER BASE, 34 1/2" HIGH, 18" or 21" DEEP

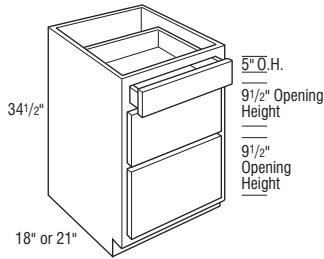

	Cubic Feet	1	2	3	4	5	6	7
VDB123418	5.4	1303	1368	1407	1473	1671	1834	1997
VDB153418	6.7	1429	1486	1540	1608	1834	1998	2162
VDB183418	7.9	1512	1597	1662	1726	1942	2154	2366
VDB213418	9.2	1640	1715	1770	1838	2105	2296	2487
VDB243418	10.4	1707	1780	1851	1936	2184	2400	2616
VDB273418	11.7	2241	2337	2431	2548	2865	3157	3449
VDB303418	12.9	2371	2473	2571	2690	3032	3335	3638
VDB333418	14.2	2431	2532	2633	2757	3110	3421	3732
VDB363418	15.4	2486	2591	2701	2821	3184	3500	3816
VDB123421	6.6	1303	1368	1407	1473	1671	1834	1997
VDB153421	8.1	1429	1486	1540	1608	1834	1998	2162
VDB183421	9.5	1512	1597	1662	1726	1942	2154	2366
VDB213421	11.0	1640	1715	1770	1838	2105	2296	2487
VDB243421	12.5	1707	1780	1851	1936	2184	2400	2616
VDB273421	14.0	2241	2337	2431	2548	2865	3157	3449
VDB303421	15.4	2371	2473	2571	2690	3032	3335	3638
VDB333421	16.9	2431	2532	2633	2757	3110	3421	3732
VDB363421	18.4	2486	2591	2701	2821	3184	3500	3816

- Increased Depths available in 1/4" increments from 21 1/4" to 24".
- Reduced Depths available in 1/4" increments from 12" to 20 3/4".

Door & Drawer Options

CC	CG	GAMD	HC	IFHG	MC	MD	MFO	PRMD	SGLPN	SHWD	SPLITDR	SPLITDRWS	TCG	TCP

End Panel Options

AUTH	CSFPE	EXBK	EXDN	FFD	FL/FR	FPE	INTGE	IPE
✓	✓	✓	✓	✓	✓	✓	✓	✓

Custom Modification Options

ADD	SHLF	ADDTK	ADRW	BVR	CBO	CCO	CFNTO	CFP	CFRMO	CLIP ¹	CMAT	CND	CSDGBK	DRWTK ²	EX	EX_OL	FD	FLUT ³	FTK ⁴	ID	IH	INFRM	IW ⁵	
						✓	✓	✓	✓	✓	✓			✓	✓	✓	✓	✓	✓	✓	✓	✓	✓	✓

MIP	OBRB	PFINBTMB	RD	REC	RECTK	RECTK_6 ⁶	RECTKFT6	RH	ROSFLUT	RT	SBCADDY	SBCADDYSM	SCPDWR	TBN	TD	TKP	TVR	UDBX ²	URT	VLSO	VTK	VWB	WS	WTR
✓	✓	✓	✓	✓	✓	✓	✓	✓	✓	✓	✓	✓	✓	✓	✓	✓	✓	✓	✓	✓	✓	✓	✓	✓

¹ Not available on 12" wide.

² Not available on 12"-21" wide.

³ 6" fluting not available on 12" or 15" wide. Fluting both 6" only available on 24"-36" wide.

⁴ FTKAV and style B-L not available on 12" wide.

⁵ Not available on 36" wide.

⁶ 12" wide can only be recessed in front and/or back. 15" and 18" wide can only be recessed in the front, back, and/or one side only. 18" deep can not be recessed in both the front and back.

Vanity Drawer Base Cabinets

VANITY FOUR DRAWER BASE, 32" HIGH, 18" or 21" DEEP

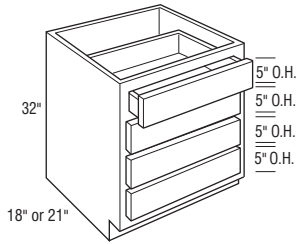

	Cubic Feet	1	2	3	4	5	6	7
4VDB123218	5.1	1497	1567	1618	1688	1919	2105	2291
4VDB153218	6.2	1641	1705	1768	1845	2105	2296	2487
4VDB183218	7.4	1732	1831	1908	1982	2225	2471	2717
4VDB213218	8.5	1881	1967	2027	2111	2415	2631	2847
4VDB243218	9.7	1958	2045	2125	2224	2505	2754	3003
4VDB273218	10.9	2571	2687	2790	2923	3289	3624	3959
4VDB303218	12.0	2722	2839	2948	3088	3478	3826	4174
4VDB333218	13.2	2790	2906	3024	3169	3565	3925	4285
4VDB363218	14.3	2855	2975	3096	3239	3652	4023	4394
4VDB123221	6.5	1497	1567	1618	1688	1919	2105	2291
4VDB153221	7.5	1641	1705	1768	1845	2105	2296	2487
4VDB183221	8.9	1732	1831	1908	1982	2225	2471	2717
4VDB213221	10.3	1881	1967	2027	2111	2415	2631	2847
4VDB243221	11.6	1958	2045	2125	2224	2505	2754	3003
4VDB273221	13.0	2571	2687	2790	2923	3289	3624	3959
4VDB303221	14.4	2722	2839	2948	3088	3478	3826	4174
4VDB333221	15.7	2790	2906	3024	3169	3565	3925	4285
4VDB363221	17.1	2855	2975	3096	3239	3652	4023	4394

- When an Inset or Beaded Inset style is selected, please refer to individual door style sections for drawer front heights that will convert to slab on pages D•11 through D•20.
- Increased Depths available in 1/4" increments from 21 1/4" to 24".
- Reduced Depths available in 1/4" increments from 12" to 20 3/4".

Door & Drawer Options

CC	CG	GAMD	HC	IFHG	MC	MD	MFO	PRMD	SGLPN	SHMD	SPLITDR	SPLITDRWS	TCG	TCP
----	----	------	----	------	----	----	-----	------	-------	------	---------	-----------	-----	-----

End Panel Options

AUTH	CSFPE	EXBK	EXDN	FFD	FL/FR	FPE	INTGE	IPE
✓	✓	✓		✓	✓	✓	✓	✓

Custom Modification Options

ADD	SHLF	ADDTK	ADRW	BVR	CBO	CCO	CFNTO	CFP	CFRMO	CLIP ¹	CMAT	CND	CSDGBK	DRWTK ²	EX	EX_OL	FD	FLUT ³	FTK	ID	IH	INVERM	IW ⁴		
						✓	✓	✓	✓	✓	✓			✓	✓	✓	✓	✓	✓	✓	✓	✓	✓	✓	
MIP	OBRB	PFINBTMB	RD	REC	RECTK	RECTK	6 ⁵	RECTKFT6	RH	ROSFLUT	RT	SBCADDY	SBCADDYSM	SCPDRW	TBN	TD	TKP	TVR	UDBX	URT	VLSO	VTK	VWB	WS ⁶	WTR
✓	✓		✓				✓	✓		✓	✓			✓			✓	✓				✓	✓	✓	✓

¹ Not available on 12" wide.

² Not available on 12"-21" wide.

³ 6" fluting not available on 12" or 15" wide. Fluting both 6" also not available on 18" or 21" wide.

⁴ Not available on 36" wide.

⁵ 12" wide can only be recessed in front and/or back. 15" and 18" wide can only be recessed in the front, back, and/or one side only. 18" deep can not be recessed in both the front and back.

⁶ Not available on 12" wide.

IH/RH availability charts starting on page G•40.
IW/RW availability charts starting on page G•46.

Vanity Drawer Base Cabinets & Sink Fronts

VANITY FOUR DRAWER BASE, 34 1/2" HIGH, 18" or 21" DEEP

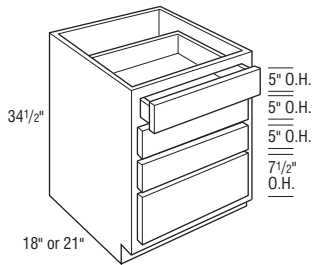

	Cubic Feet	1	2	3	4	5	6	7
4VDB123418	5.4	1564	1642	1688	1768	2005	2202	2399
4VDB153418	6.7	1716	1784	1848	1929	2202	2398	2594
4VDB183418	7.9	1815	1915	1995	2072	2330	2585	2840
4VDB213418	9.2	1967	2058	2125	2207	2526	2754	2982
4VDB243418	10.4	2049	2136	2222	2324	2620	2880	3140
4VDB273418	11.7	2690	2806	2918	3057	3437	3788	4139
4VDB303418	12.9	2844	2967	3085	3229	3639	4002	4365
4VDB333418	14.2	2918	3039	3160	3308	3731	4105	4479
4VDB363418	15.4	2983	3110	3240	3384	3821	4200	4579
4VDB123421	6.6	1564	1642	1688	1768	2005	2202	2399
4VDB153421	8.1	1716	1784	1848	1929	2202	2398	2594
4VDB183421	9.5	1815	1915	1995	2072	2330	2585	2840
4VDB213421	11.0	1967	2058	2125	2207	2526	2754	2982
4VDB243421	12.5	2049	2136	2222	2324	2620	2880	3140
4VDB273421	14.0	2690	2806	2918	3057	3437	3788	4139
4VDB303421	15.4	2844	2967	3085	3229	3639	4002	4365
4VDB333421	16.9	2918	3039	3160	3308	3731	4105	4479
4VDB363421	18.4	2983	3110	3240	3384	3821	4200	4579

- When an Inset or Beaded Inset style is selected, please refer to individual door style sections for drawer front heights that will convert to slab on pages D•11 through D•20.
- Increased Depths available in 1/4" increments from 21 1/4" to 24".
- Reduced Depths available in 1/4" increments from 12" to 20 3/4".

Door & Drawer Options

CC	CG	GAMD	HC	IFHG	MC	MD	MFO	PRMD	SGLPN	SHMD	SPLITDR	SPLITDRWS	TCG	TCP

End Panel Options

AUTH	CSFPE	EXBK	EXDN	FFD	FL/FR	FPE	INTGE	IPE
✓	✓	✓	✓	✓	✓	✓	✓	✓

Custom Modification Options

ADD	SHLF	ADDTK	ADRW	BVR	CBO	CCO	CFNT0	CFP	CFRMO	CLIP ¹	CMAT	CND	CSDGBK	DRWTK ²	EX	EX_OL	FD	FLUT ³	FTK	ID	IH	INVFRM	IW ⁴	
MIP	OBRB	PFINBTMB	RD	REC	RECTK	RECTK_6 ⁵	RECTKFR6	RH	ROSFLUT	RT	SBCADDY	SBCADDYSM	SCPDWR	TBN	TD	TKP	TVR	UDBX	URT	VLSO	VTK	VWB	WS ⁶	WTR
✓	✓		✓	✓	✓	✓	✓	✓	✓	✓	✓	✓	✓	✓	✓	✓	✓	✓	✓	✓	✓	✓	✓	✓

¹ Not available on 12" wide.

² Not available on 12" or 21" wide.

³ 6" fluting not available on 12" or 15" wide. Fluting both 6" also not available on 18" or 21" wide.

⁴ Not available on 36" wide.

⁵ 12" wide can only be recessed in front and/or back. 15" and 18" wide can only be recessed in the front, back, and/or one side only. 18" deep can not be recessed in both the front and back.

⁶ Not available on 12" wide.

VANITY ANGLED CORNER SINK FRONT, 32" HIGH

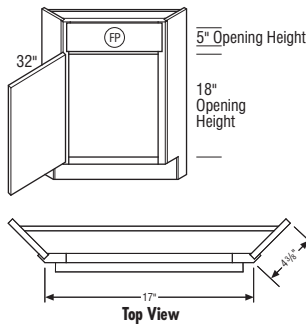

VACSF L or R	2.9	1276	1329	1370	1441	1517	1653	1789
--------------	-----	------	------	------	------	------	------	------

- Floor included and packed separately.
- Tilt-out tray available as an accessory.
- Touch-up kit (TUK) and Owner's Guide included.

(FP) False Panel

Door & Drawer Options

CC	CG	GAMD	HC	IFHG	MC	MD	MFO	PRMD	SGLPN	SHMD	SPLITDR	SPLITDRWS	TCG	TCP
✓				✓		✓		✓						

End Panel Options

AUTH	CSFPE	EXBK	EXDN	FFD	FL/FR	FPE	INTGE	IPE

Custom Modification Options

ADD	SHLF	ADDTK	ADRW	BVR	CBO	CCO	CFNT0	CFP	CFRMO	CLIP	CMAT	CND	CSDGBK	DRWTK	EX	EX_OL	FD	FLUT	FTK	ID	IH	INVFRM	IW	
MIP	OBRB	PFINBTMB	RD	REC	RECTK	RECTK_6	RECTKFR6	RH	ROSFLUT	RT	SBCADDY	SBCADDYSM	SCPDWR	TBN	TD	TKP	TVR	UDBX	URT	VLSO	VTK	VWB	WS	WTR
✓	✓																							

Under Counter Drawers

UNDER COUNTER DRAWER, 5" HIGH, 18" or 21" DEEP

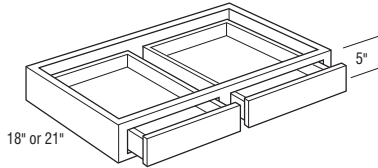
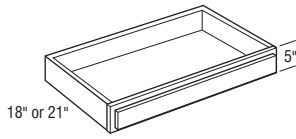

	Cubic Feet	1	2	3	4	5	6	7
UCD1518	1.3	467	467	467	467	467	467	467
UCD1818	1.5	485	485	485	485	485	485	485
UCD2118	1.7	512	512	512	512	512	512	512
UCD2418	2.0	544	544	544	544	544	544	544
UCD2718	2.2	582	582	582	582	582	582	582
UCD1521	1.5	467	467	467	467	467	467	467
UCD1821	1.7	485	485	485	485	485	485	485
UCD2121	2.0	512	512	512	512	512	512	512
UCD2421	2.3	544	544	544	544	544	544	544
UCD2721	2.5	582	582	582	582	582	582	582
UCD3018	2.5	586	586	586	586	586	586	586
UCD3318	2.7	618	618	618	618	618	618	618
UCD3618	2.9	636	636	636	636	636	636	636
UCD3021	2.8	586	586	586	586	586	586	586
UCD3321	3.0	618	618	618	618	618	618	618
UCD3621	3.3	636	636	636	636	636	636	636

- Karis and Montgomery will utilize a 5-piece drawer front, all other styles will be slab.
- When an Inset or Beaded Inset style is selected, drawer fronts will be slab.
- Increased Depths available in 1/4" increments from 21 1/4" to 24".
- Reduced Depths available in 1/4" increments from 12" to 20 3/4".

Door & Drawer Options

CC	CG	GAMD	HC	IFHG	MC	MD	MFO	PRMD	SGLPN	SHMD	SPLITDR	SPLITDRWS	TCG	TCP
----	----	------	----	------	----	----	-----	------	-------	------	---------	-----------	-----	-----

End Panel Options

AUTH	CSFPE	EXBK	EXDN	FFD	FL/FR	FPE	INTGE	IPE
	✓	✓			✓	✓		

Custom Modification Options

ADD	SHLF	ADTK	ADRW	BVR	CBO	CCO	CFNTD	CFP	CFRMO	CLIP	CMAT	CND	CSDGBK	DRWTK	EX	EX_OL	FD	FLUT	FTK	ID	IH	INVFRM	IW ¹	
										✓					✓						✓	✓		✓

MIP	OBRB	PFINBTMB	RD	REC	RECTK	RECTK_6	RECTKFR6	RH	ROSFLUT	RT	SBCADDY	SBCADDYSM	SCPDRW	TBN	TD	TKP	TVR	UBX	URT	VLSD	VTK	VWB	WS	WTR	
✓			✓																					✓	✓

¹ Not available on 36" wide.

UNDER COUNTER DRAWER, TRIMMABLE, 5" HIGH, 21" DEEP

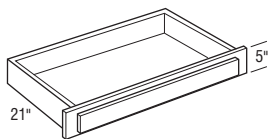

UCD2418T	2.3	519	519	519	519	519	519	519
UCD2721T	2.5	544	544	544	544	544	544	544
UCD3024T	2.8	583	583	583	583	583	583	583
UCD3630T	3.3	625	625	625	625	625	625	625
UCD4236T	3.8	686	686	686	686	686	686	686

- Trimmable up to 6".
- When an Inset or Beaded Inset style is selected, drawer fronts will be slab.
- Karis and Montgomery will utilize a 5-piece drawer front, all other styles will be slab.
- Increased Depths available in 1/4" increments from 21 1/4" to 24".
- Reduced Depths available in 1/4" increments from 12" to 20 3/4".

Door & Drawer Options

CC	CG	GAMD	HC	IFHG	MC	MD	MFO	PRMD	SGLPN	SHMD	SPLITDR	SPLITDRWS	TCG	TCP
----	----	------	----	------	----	----	-----	------	-------	------	---------	-----------	-----	-----

End Panel Options

AUTH	CSFPE	EXBK	EXDN	FFD	FL/FR	FPE	INTGE	IPE
	✓	✓			✓	✓		

Custom Modification Options

ADD	SHLF	ADTK	ADRW	BVR	CBO	CCO	CFNTD	CFP	CFRMO	CLIP	CMAT	CND	CSDGBK	DRWTK	EX ¹	EX_OL	FD	FLUT	FTK	ID	IH	INVFRM	IW ²	
										✓					✓						✓	✓		✓

MIP	OBRB	PFINBTMB	RD	REC	RECTK	RECTK_6	RECTKFR6	RH	ROSFLUT	RT	SBCADDY	SBCADDYSM	SCPDRW	TBN	TD	TKP	TVR	UBX	URT	VLSD	VTK	VWB	WS	WTR	
✓			✓																					✓	✓

¹ Only available on 24" wide.

² Not available on 36" or 42" wide.

IH/RH availability charts starting on page G•40.
IW/RW availability charts starting on page G•46.

VANITY UTILITY, 84" or 87" HIGH, 21" DEEP

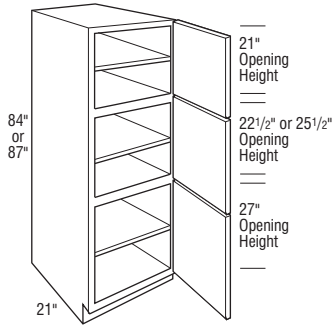

	Cubic Feet	1	2	3	4	5	6	7
UV158421 L or R	19.2	2315	2430	2514	2652	2789	3047	3305
UV188421 L or R	22.7	2410	2524	2622	2764	2914	3186	3458
UV218421 L or R	26.2	2534	2658	2749	2904	3068	3357	3646
UV248421 L or R	29.7	2679	2812	2907	3064	3224	3524	3824
UV158721 L or R	19.9	2526	2650	2745	2891	3063	3347	3631
UV188721 L or R	23.5	2644	2768	2866	3025	3203	3497	3791
UV218721 L or R	27.1	2786	2919	3023	3185	3377	3686	3995
UV248721 L or R	30.7	2920	3062	3170	3340	3537	3866	4195

- Includes three adjustable shelves.
- Increased Depths available in 1/4" increments from 21 1/4" to 30".
- Reduced Depths available in 1/4" increments from 6" to 20 3/4".

Door & Drawer Options

CC	CG	GAMD	HC	IFHG	MC	MD	MFO	PRMD	SGLPN	SHMD	SPLITDR	SPLITDRWS	TCG	TCP
✓	✓	✓	✓	✓	✓	✓	✓	✓	✓	✓	✓	✓	✓	✓

End Panel Options

AUTH	CSFPE	EXBK	EXDN	FFD	FL/FR	FPE	INTGE	IPE
✓	✓	✓	✓	✓	✓	✓	✓	✓

Custom Modification Options

ADD	SHLF	ADDTK	ADRW	BVR	CBO	CCO	CFNTO	CFP	CFRMO	CLIP	CMAT	CND	CSDGBK	DRWTK ¹	EX	EX_OL	FD	FLUT ²	FTK	ID	IH	INVFRM	IW ³	
					✓	✓	✓		✓	✓	✓	✓	✓	✓	✓	✓	✓	✓	✓	✓	✓	✓	✓	✓

MIP	OBRB	PFINBTMB	RD	REC	RECTK	RECTK_6	RECTKFR6	RH	ROSFLUT ⁴	RT	SBCADDY	SBCADDYSM	SCPDWR	TBN	TD	TKP	TVR ⁵	UDBX	URT	VLSO	VTK	VWB	WS	WTR
✓	✓	✓	✓	✓	✓	✓	✓	✓	✓	✓	✓	✓	✓	✓	✓	✓	✓	✓	✓	✓	✓	✓	✓	✓

- ¹ Only available on 24" wide.
² Fluting both 3" not available on 1584 version. Not available with 6" fluting.
³ Not available on 24" wide.
⁴ Fluting both not available on 1584 version.
⁵ Not available on 2484 version.

VANITY UTILITY, 90" or 93" HIGH, 21" DEEP

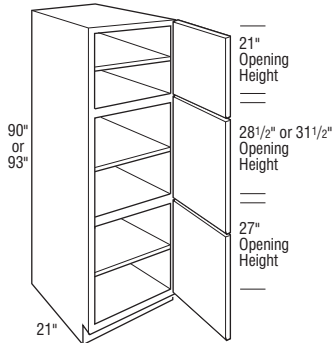

	20.5	2781	2913	3018	3181	3369	3681	3993
UV159021 L or R	20.5	2781	2913	3018	3181	3369	3681	3993
UV189021 L or R	24.3	2907	3047	3154	3325	3524	3847	4170
UV219021 L or R	28.0	3063	3211	3324	3502	3710	4053	4396
UV249021 L or R	31.7	3212	3367	3486	3675	3895	4253	4611
UV159321 L or R	21.2	3058	3206	3320	3497	3705	4046	4387
UV189321 L or R	25.1	3197	3351	3469	3660	3875	4232	4589
UV219321 L or R	28.9	3369	3531	3655	3853	4080	4458	4836
UV249321 L or R	32.8	3533	3703	3834	4042	4282	4676	5070

- Includes three adjustable shelves.
- 90" high toe kick shipped attached.
- 93" high is shipped with loose toe kick unless ATTK or Flush Toe kick is specified.
- Increased Depths available in 1/4" increments from 21 1/4" to 30".
- Reduced Depths available in 1/4" increments from 6" to 20 3/4".

Door & Drawer Options

CC	CG	GAMD	HC	IFHG	MC	MD	MFO	PRMD	SGLPN	SHMD	SPLITDR	SPLITDRWS	TCG	TCP
✓	✓	✓	✓	✓	✓	✓	✓	✓	✓	✓	✓	✓	✓	✓

End Panel Options

AUTH	CSFPE	EXBK	EXDN	FFD	FL/FR	FPE	INTGE	IPE
✓	✓	✓	✓	✓	✓	✓	✓	✓

Custom Modification Options

ADD	SHLF	ADDTK ¹	ADRW	BVR	CBO	CCO	CFNTO	CFP	CFRMO	CLIP	CMAT	CND	CSDGBK	DRWTK ²	EX	EX_OL	FD	FLUT ³	FTK	ID	IH	INVFRM	IW ⁴	
		✓			✓	✓	✓		✓	✓	✓	✓	✓	✓	✓	✓	✓	✓	✓	✓	✓	✓	✓	✓

MIP	OBRB	PFINBTMB	RD	REC	RECTK	RECTK_6	RECTKFR6	RH	ROSFLUT ⁵	RT	SBCADDY	SBCADDYSM	SCPDWR	TBN	TD	TKP	TVR ⁶	UDBX	URT	VLSO	VTK	VWB	WS	WTR
✓	✓	✓	✓	✓	✓	✓	✓	✓	✓	✓	✓	✓	✓	✓	✓	✓	✓	✓	✓	✓	✓	✓	✓	✓

- ¹ Only available on 93" high.
² Only available on 24" wide.
³ Fluting both 3" not available on 1590 version. Not available with 6" fluting.
⁴ Not available on 24" wide.
⁵ Fluting both not available on 1590 version.
⁶ Not available on 2490 version.

Vanity Utility Cabinets

VANITY UTILITY, 96" HIGH, 21" DEEP

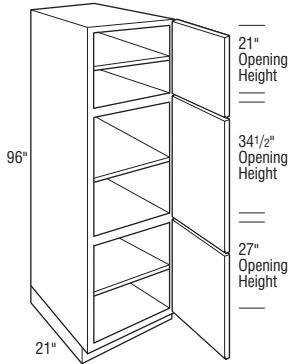

	Cubic Feet	1	2	3	4	5	6	7
UV159621 L or R	21.9	3217	3372	3490	3681	3898	4258	4618
UV189621 L or R	25.9	3363	3526	3650	3848	4076	4452	4828
UV219621 L or R	29.8	3543	3714	3844	4053	4295	4689	5083
UV249621 L or R	33.8	3715	3896	4030	4253	4501	4919	5337

- Includes three adjustable shelves.
- Increased Depths available in 1/4" increments from 21 1/4" to 30".
- Reduced Depths available in 1/4" increments from 6" to 20 3/4".

Door & Drawer Options

CC	CG	GAMD	HC	IFHG	MC	MD	MFO	PRMD	SGLPN	SHMD	SPLITDR	SPLITDRWS	TCG	TCP
✓	✓		✓			✓	✓	✓		✓				

End Panel Options

AUTH	CSFPE	EXBK	EXDN	FFD	FL/FR	FPE	INTGE	IPE
✓	✓	✓		✓	✓	✓	✓	✓

Custom Modification Options

ADD_SHLF	ADDTK	ADRW	BVR	CBO	CCO	CFNTD	CFP	CFRMO	CLIP	CMAT	CND	CSDGBK	DRWTK ¹	EX	EX_OL	FD	FLUT ²	FTK	ID	IH	INVFRM	IW ³	
✓	✓			✓	✓	✓	✓	✓			✓	✓	✓	✓	✓	✓	✓	✓	✓	✓	✓	✓	✓

MIP	OBRB	PFINBTMB	RD	REC	RECTK	RECTK_6	RECTKFR76	RH	ROSFLUT ⁴	RT	SBCADDY	SBCADDYSM	SCPDRW	TBN	TD	TKP	TVR ⁴	UDBX	URT	VLSO	VTK	VWB	WS	WTR
✓	✓		✓						✓	✓							✓	✓					✓	✓

- ¹ Only available on 24" wide.
² Not available on 24" wide. Fluting both 3" not available on 15" wide. Not available with 6" fluting.
³ Not available on 24" wide.
⁴ Not available on 24" wide. Fluting both not available on 15" wide.

VANITY UTILITY, 84" or 87" HIGH, 21" DEEP

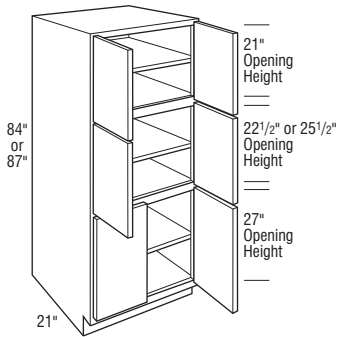

UV248421	29.7	3371	3533	3660	3855	4084	4461	4838
UV248721	30.7	3708	3886	4023	4244	4494	4908	5322

- Includes three adjustable shelves.
- Increased Depths available in 1/4" increments from 21 1/4" to 30".
- Reduced Depths available in 1/4" increments from 6" to 20 3/4".

Door & Drawer Options

CC	CG	GAMD	HC	IFHG	MC	MD	MFO	PRMD	SGLPN	SHMD	SPLITDR ¹	SPLITDRWS	TCG	TCP
✓	✓		✓			✓	✓	✓		✓	✓			

End Panel Options

AUTH	CSFPE	EXBK	EXDN	FFD	FL/FR	FPE	INTGE	IPE
✓	✓	✓		✓	✓	✓	✓	✓

Custom Modification Options

ADD_SHLF	ADDTK	ADRW	BVR	CBO	CCO	CFNTD	CFP	CFRMO	CLIP	CMAT	CND	CSDGBK	DRWTK	EX	EX_OL	FD	FLUT ²	FTK	ID	IH	INVFRM	IW	
✓	✓			✓	✓	✓	✓	✓			✓	✓	✓	✓	✓	✓	✓	✓	✓	✓	✓	✓	✓

MIP	OBRB	PFINBTMB	RD	REC	RECTK	RECTK_6	RECTKFR76	RH	ROSFLUT ³	RT	SBCADDY	SBCADDYSM	SCPDRW	TBN	TD	TKP	TVR	UDBX	URT	VLSO	VTK	VWB	WS	WTR
✓	✓		✓						✓	✓							✓	✓					✓	✓

- ¹ Not available on 84" high.
² Not available on 87" high. Not available with 6" fluting.
³ Not available on 87" high.

IH/RH availability charts starting on page G•40.
 IW/RW availability charts starting on page G•46.

VANITY UTILITY, 90" or 93" HIGH, 21" DEEP

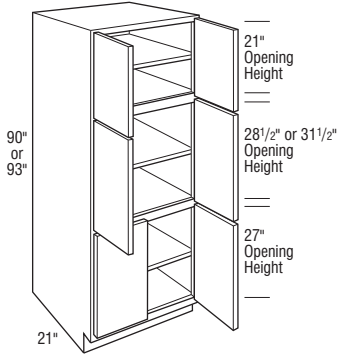

	Cubic Feet	1	2	3	4	5	6	7
UV249021	31.7	4078	4275	4429	4669	4944	5399	5854
UV249321	32.8	4489	4702	4868	5134	5437	5939	6441

- Includes three adjustable shelves.
- 90" high toe kick shipped attached.
- 93" high is shipped with loose toe kick unless ATTK or Flush Toe kick is specified.
- Increased Depths available in 1/4" increments from 21 1/4" to 30".
- Reduced Depths available in 1/4" increments from 6" to 20 3/4".

Door & Drawer Options

CC	CG	GAMD	HC	IFHG	MC	MD	MFO	PRMD	SGLPN	SHMD	SPLITDR ¹	SPLITDRWS	TCG	TCP
✓	✓	✓	✓	✓	✓	✓	✓	✓	✓	✓	✓	✓	✓	✓

End Panel Options

AUTH	CSFPE	EXBK	EXDN	FFD	FL/FR	FPE	INTGE	IPE
✓	✓	✓	✓	✓	✓	✓	✓	✓

Custom Modification Options

ADD_SHLF	ADDTK ²	ADRW	BVR	CBO	CCO	CFNTO	CFP	CFRMO	CLIP	CMAT	CND	CSDGBK	DRWTK	EX	EX_OL	FD	FLUT ³	FTK	ID	IH	INFRM	IW	
✓	✓	✓	✓	✓	✓	✓	✓	✓	✓	✓	✓	✓	✓	✓	✓	✓	✓	✓	✓	✓	✓	✓	✓

MIP	OBRB	PFINBTMB	RD	REC	RECTK	RECTK_6	RECTKRT6	RH	ROSFLUT ⁴	RT	SBCADDY	SBCADDYSM	SCPDWR	TBN	TD	TKP	TVR	UDBX	URT	VLSO	VTK	VWB	WS	WTR
✓	✓	✓	✓	✓	✓	✓	✓	✓	✓	✓	✓	✓	✓	✓	✓	✓	✓	✓	✓	✓	✓	✓	✓	✓

¹ Not available on 90" high.

² Only available on 93" high.

³ Not available on 93" high. Not available with 6" fluting.

⁴ Not available on 93" high.

VANITY UTILITY, 96" HIGH, 21" DEEP

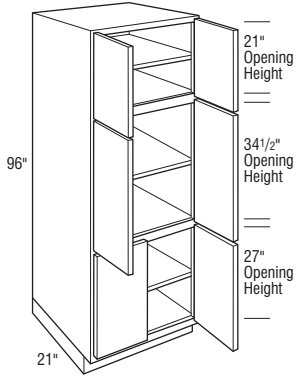

	Cubic Feet	1	2	3	4	5	6	7
UV249621	33.8	4719	4947	5121	5399	5718	6246	6774

- Includes three adjustable shelves.
- Increased Depths available in 1/4" increments from 21 1/4" to 30".
- Reduced Depths available in 1/4" increments from 6" to 20 3/4".

Door & Drawer Options

CC	CG	GAMD	HC	IFHG	MC	MD	MFO	PRMD	SGLPN	SHMD	SPLITDR	SPLITDRWS	TCG	TCP
✓	✓	✓	✓	✓	✓	✓	✓	✓	✓	✓	✓	✓	✓	✓

End Panel Options

AUTH	CSFPE	EXBK	EXDN	FFD	FL/FR	FPE	INTGE	IPE
✓	✓	✓	✓	✓	✓	✓	✓	✓

Custom Modification Options

ADD_SHLF	ADDTK	ADRW	BVR	CBO	CCO	CFNTO	CFP	CFRMO	CLIP	CMAT	CND	CSDGBK	DRWTK	EX	EX_OL	FD	FLUT ¹	FTK	ID	IH	INFRM	IW	
✓	✓	✓	✓	✓	✓	✓	✓	✓	✓	✓	✓	✓	✓	✓	✓	✓	✓	✓	✓	✓	✓	✓	✓

MIP	OBRB	PFINBTMB	RD	REC	RECTK	RECTK_6	RECTKRT6	RH	ROSFLUT	RT	SBCADDY	SBCADDYSM	SCPDWR	TBN	TD	TKP	TVR	UDBX	URT	VLSO	VTK	VWB	WS	WTR
✓	✓	✓	✓	✓	✓	✓	✓	✓	✓	✓	✓	✓	✓	✓	✓	✓	✓	✓	✓	✓	✓	✓	✓	✓

¹ Not available with 6" fluting.

Vanity Utility & Linen Closet Cabinets

VANITY UTILITY with DRAWERS, 84" HIGH, 21" DEEP

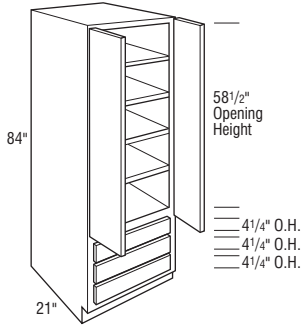
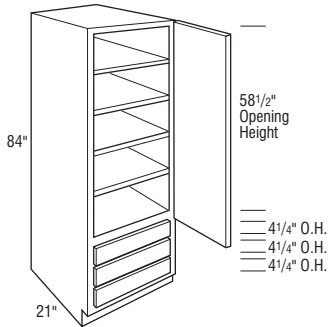

	Cubic Feet	1	2	3	4	5	6	7
VUD188421 L or R	22.7	3120	3273	3385	3571	3767	4115	4463
VUD248421 L or R	29.7	3382	3547	3668	3875	4083	4461	4839
VUD248421	29.7	3639	3817	3951	4165	4409	4819	5229

Notes below apply to all products in section above:

- Includes four adjustable shelves.
- When an Inset or Beaded Inset style is selected, drawer fronts will be slab.
- Bottom section of drawers does not match vanity base height.
- Large opening on tall doors will include two center panels divided by a horizontal rail.
- Increased Depths available in 1/4" increments from 21 1/4" to 24".
- Reduced Depths available in 1/4" increments from 12" to 20 3/4".

Door & Drawer Options

CC	CG	GAMD	HC	IFHG	MC	MD	MFO	PRMD	SGLPN	SHMD	SPLITDR	SPLITDRWS	TCG	TCP
✓	✓			✓			✓		✓					

End Panel Options

AUTH	CSFPE	EXBK	EXDN	FFD	FL/FR	FPE	INTGE	IPE
✓	✓	✓		✓	✓	✓	✓	✓

Custom Modification Options

ADD_SHLF	ADDTK	ADRW	BVR	CBO	CCO	CFNT0	CFP	CFRMO	CLIP ¹	CMAT	CND	CSDGBK	DRWTK ¹	EX	EX_OL	FD	FLUT ³	FTK	ID	IH	INVFRM	IW	
				✓	✓	✓		✓	✓		✓	✓	✓	✓	✓	✓	✓	✓	✓	✓	✓	✓	✓

MIP	OBRB	PFINBTMB	RD	REC	RECTK	RECTK_6	RECTKFR16	RH	ROSLUT	RT	SBCADDY	SBCADDYSM	SCPDWR	TBN	TD	TKP	TVR	UDBX	URT	VLSO	VTK	VWB	WS	WTR	
✓	✓		✓						✓	✓								✓				✓	✓	✓	✓

¹ Not available on 24" (2 doors) wide.

² Not available on 18" wide.

³ Not available with 6" fluting.

LINEN CLOSET, 84" HIGH, 21" DEEP

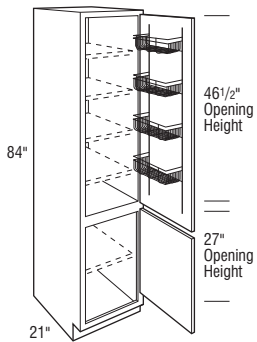

	Cubic Feet	1	2	3	4	5	6	7
LC188421 L or R	22.7	2660	2777	2875	3015	3169	3440	3711

- Upper section includes a 5" deep chrome door rack.
- Upper section includes four adjustable shelves that are 13 1/4" deep.
- Lower section includes one adjustable shelf that is 19 1/4" deep.
- Increased Depths available in 3" increments to 24".
- Reduced Depths available in 3" increments from 15" to 18".
- Not available on Inset and Beaded Inset styles.

Door & Drawer Options

CC	CG	GAMD	HC	IFHG	MC	MD	MFO	PRMD	SGLPN	SHMD	SPLITDR	SPLITDRWS	TCG	TCP
✓	✓													

End Panel Options

AUTH	CSFPE	EXBK	EXDN	FFD	FL/FR	FPE	INTGE	IPE
✓	✓	✓		✓	✓	✓	✓	✓

Custom Modification Options

ADD_SHLF	ADDTK	ADRW	BVR	CBO	CCO	CFNT0	CFP	CFRMO	CLIP	CMAT	CND	CSDGBK	DRWTK	EX	EX_OL	FD	FLUT ¹	FTK	ID	IH	INVFRM	IW	
				✓	✓	✓		✓						✓	✓	✓	✓	✓	✓	✓	✓	✓	✓

MIP	OBRB	PFINBTMB	RD	REC	RECTK	RECTK_6	RECTKFR16	RH	ROSLUT	RT ²	SBCADDY	SBCADDYSM	SCPDWR	TBN	TD	TKP	TVR	UDBX	URT	VLSO	VTK	VWB	WS	WTR	
✓	✓		✓						✓	✓								✓				✓	✓	✓	✓

¹ Not available with 6" fluting.

² Only available on lower section.

IH/RH availability charts starting on page G-40.
IW/RW availability charts starting on page G-46.

LINEN CLOSET with REMOVABLE HAMPER, 84" HIGH, 21" DEEP

L O G I X

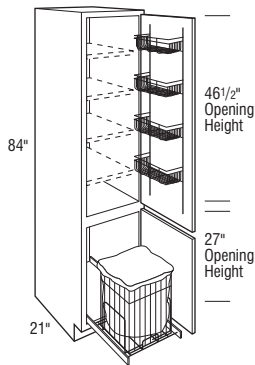

Cubic Feet	1	2	3	4	5	6	7	
LCRH188421 L or R	22.7	3496	3615	3710	3850	4003	4275	4547

- Upper section includes a 5" deep chrome door rack.
- Includes four adjustable shelves that are 13 1/4" deep.
- Hamper utilizes floor mounted glides.
- Hamper size is 14 9/16" W x 18 15/16" H x 17 23/32" D.
- Chrome basket with creme linen liner.
- Increased Depths available in 1/4" increments from 21 1/4" to 30".
- Not available on Inset and Beaded Inset styles.

Door & Drawer Options

CC	CG	GAMD	HC	IFHG	MC	MD	MFO	PRMD	SGLPN	SHMD	SPLITDR	SPLITDRWS	TCG	TCP

End Panel Options

AUTH	CSFPE	EXBK	EXDN	FFD	FL/FR	FPE	INTGE	IPE
✓	✓	✓	✓	✓	✓	✓	✓	✓

Custom Modification Options

ADD	SHLF	ADDTK	ADRW	BVR	CBO	CCO	CFNT0	CFP	CFRMO	CLIP	CMAT	CND	CSDGBK	DRWTK	EX	EX_OL	FD	FLUT ¹	FTK	ID	IH	INVFRM	IW	

MIP	OBRB	PFINBTMB	RD	REC	RECTK	RECTK_6	RECTKFR ⁶	RH	ROSFLUT	RT	SBCADDY	SBCADDYSM	SCPDRW	TBN	TD	TKP	TVR	UDBX	URT	VLSO	VTK	VWB	WS	WTR	
✓	✓				✓					✓							✓	✓				✓		✓	✓

¹ Not available with 6" fluting.

LINEN STORAGE CABINET, 84" HIGH, 18" or 21" DEEP

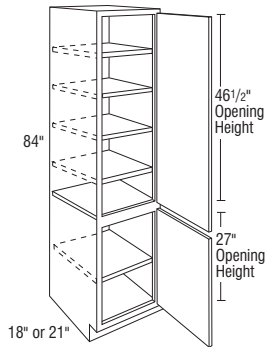

LT188418 L or R	19.9	2500	2610	2702	2834	2979	3233	3487
LT218418 L or R	22.9	2997	3129	3240	3397	3571	3876	4181
LT188421 L or R	22.9	2500	2610	2702	2834	2979	3233	3487
LT218421 L or R	26.3	2997	3129	3240	3397	3571	3876	4181

- Shelves indicated by light dotted lines are included, but packaged separately.
- Shelf indicated by solid line is fixed.
- Recommended for use with 34 1/2" high cabinets (bottom door will align with top of drawer front or top of full height door).
- Increased Depths available in 1/4" increments from 21 1/4" to 30".
- Reduced Depths available in 1/4" increments from 12" to 20 3/4".

Door & Drawer Options

CC	CG	GAMD	HC	IFHG	MC	MD ¹	MFO	PRMD ¹	SGLPN	SHMD	SPLITDR	SPLITDRWS	TCG	TCP
✓						✓	✓	✓						

End Panel Options

AUTH	CSFPE	EXBK	EXDN	FFD	FL/FR	FPE	INTGE	IPE
✓	✓	✓	✓	✓	✓	✓	✓	✓

Custom Modification Options

ADD	SHLF	ADDTK	ADRW	BVR	CBO	CCO	CFNT0	CFP	CFRMO	CLIP	CMAT	CND	CSDGBK	DRWTK	EX	EX_OL	FD	FLUT ²	FTK	ID ³	IH	INVFRM	IW	

MIP	OBRB	PFINBTMB	RD	REC	RECTK	RECTK_6	RECTKFR ⁶	RH	ROSFLUT	RT	SBCADDY	SBCADDYSM	SCPDRW	TBN	TD	TKP	TVR	UDBX	URT	VLSO	VTK	VWB	WS	WTR
			✓		✓																		✓	✓

¹ Only available on top section.

² Not available with 6" fluting.

³ Not available on 18" deep.

Bath and Vanity Cabinets

BATH WALL HUNG SINK CONSOLE, 21" HIGH, 21" DEEP

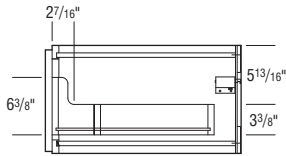
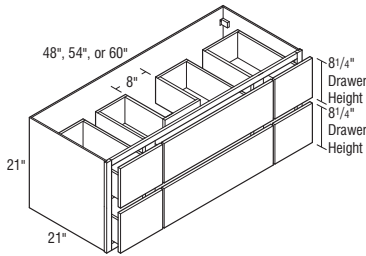

Top U-shaped drawer box has cascading side drawer feature.

	Cubic Feet	1	2	3	4	5	6	7
BCWHC4821	14.9	3377	3553	3675	3873	4083	4457	4831
BCWHC5421	16.7	3504	3688	3816	4021	4237	4628	5019
BCWHC6021	18.5	3633	3825	3955	4168	4393	4798	5203

- Six drawers.
- Top middle drawer is U-shaped.
- Includes hanging hardware.
- Flush Finished Ends standard.
- Sink bowl clearance to top of drawer box is 5 13/16".
- Touch-up kit (TUK) and Owner's Guide included.
- Unit must be securely fastened with sufficient type, quantity, and size of screws to all available wall studs and internal structural wall blocking placed between wall studs.
- Do not exceed loading of 25 lbs. / SF for countertop and sink.
- Do not exceed loading of 15 lbs. / SF for contents on shelves and/or in drawers.
- Avoid use of concrete or other heavy masonry countertops.
- Installation to be performed by qualified professionals only.
- Securing the end panels and face frame to the structural members available is recommended during installation. When ID is specified, the cabinet MUST be fastened to adjacent cabinets or to structural members on each side in addition to the back installation instructions.

Door & Drawer Options

CC	CG	GAMD	HC	IFHG	MC	MD	MFO	PRMD	SGLPN	SHMD	SPLITDR	SPLITDRWS	TCG	TCP
----	----	------	----	------	----	----	-----	------	-------	------	---------	-----------	-----	-----

End Panel Options

AUTH	CSFPE	EXBK	EXDN	FFD	FL/FR	FPE	INTGE	IPE
✓	✓							✓

Custom Modification Options

ADD_SHLF	ADDTK	ADRW	BVR	CBO	CCO	CFNTO	CFP	CFRMO	CLIP	CMAT	CND	CSDGBK	DRWTK	EX	EX_OL	FD	FLUT	FTK	ID	IH	INVFRM	IW ¹	
				✓	✓	✓	✓	✓				✓		✓	✓	✓	✓	✓	✓	✓	✓	✓	✓

MIP	OBRB	PFINBTMB	RD	REC	RECTK	RECTK_6	RECTKFRT6	RH	ROSLUT	RT	SBCADDY	SBCADDYSM	SCPDWR	TBN	TD	TKP	TVR	UDBX	URT	VLSO	VTK	VWB	WS	WTR
✓									✓														✓	✓

¹ Not available on 60" wide.

U-SHAPED DRAWER ON SELECT BATH BASE CABINETS

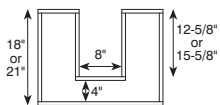

IH/RH availability charts starting on page G•40.
IW/RW availability charts starting on page G•46.

BATH SINK WALL TOWER, 48" HIGH, 21" DEEP

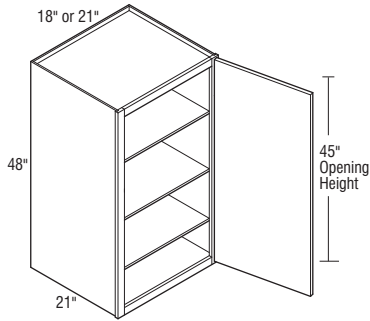

Cubic Feet	1	2	3	4	5	6	7
BCWT1848 L or R	12.8	1322	1393	1441	1519	1602	1894
BCWT2148 L or R	14.8	1375	1448	1498	1577	1666	1966

- Three adjustable shelves.
- Finished ends standard.
- No toekick.
- See page P●67 for optional legs.
- Blocking for use with legs pre-installed.

Door & Drawer Options

CC	CG	GAMD	HC	IFHG	MC	MD	MFO	PRMD	SGLPN	SHMD	SPLITDR	SPLITDRWS	TCG	TCP
✓	✓	✓	✓	✓	✓	✓	✓	✓	✓	✓	✓	✓	✓	✓

End Panel Options

AUTH	CSFPE	EXBK	EXDN	FFD	FL/FR	FPE	INTGE	IPE
✓	✓	✓	✓	✓	✓	✓	✓	✓

Custom Modification Options

ADD_SHLF	ADDTK	ADRW	BVR	CBO	CCO	CFNTO	CFP	CFRMO	CLIP	CMAT	CND	CSDGBK	DRWTK	EX	EX_OL	FD	FLUT ¹	FTK	ID	IH	INVFRM	IW	
	✓	✓	✓	✓	✓	✓	✓	✓	✓	✓	✓	✓	✓	✓	✓	✓	✓	✓	✓	✓	✓	✓	✓

MIP	OBRB	PFINBTMB	RD	REC	RECTK	RECTK_6	RECTKFR6	RH	ROSFLUT	RT	SBCADDY	SBCADDYSM	SCPDWR	TBN	TD	TKP	TVR	UDBX	URT	VLSO	VTK	VWB	WS	WTR
✓	✓	✓	✓	✓	✓	✓	✓	✓	✓	✓	✓	✓	✓	✓	✓	✓	✓	✓	✓	✓	✓	✓	✓	✓

¹ Not available with 6" fluting.

BATH BASE CABINET, 36" HIGH, 21" DEEP

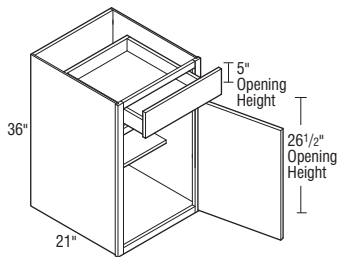

BCB15NTK L or R	7.1	1206	1268	1313	1381	1458	1592	1726
BCB18NTK L or R	8.4	1256	1321	1368	1441	1520	1658	1796
BCB21NTK L or R	9.7	1308	1375	1425	1500	1581	1726	1871

- One adjustable 15" deep shelf.
- Finished Ends standard.
- No toekick.
- See page P●67 for optional legs.
- Blocking for use with legs pre-installed.

Door & Drawer Options

CC	CG	GAMD	HC	IFHG	MC	MD	MFO	PRMD	SGLPN	SHMD	SPLITDR	SPLITDRWS	TCG	TCP
✓	✓	✓	✓	✓	✓	✓	✓	✓	✓	✓	✓	✓	✓	✓

End Panel Options

AUTH	CSFPE	EXBK	EXDN	FFD	FL/FR	FPE	INTGE	IPE
✓	✓	✓	✓	✓	✓	✓	✓	✓

Custom Modification Options

ADD_SHLF	ADDTK	ADRW	BVR	CBO	CCO	CFNTO	CFP	CFRMO	CLIP	CMAT	CND	CSDGBK	DRWTK	EX	EX_OL	FD	FLUT ¹	FTK	ID	IH	INVFRM	IW	
			✓	✓	✓	✓	✓	✓	✓	✓	✓	✓	✓	✓	✓	✓	✓	✓	✓	✓	✓	✓	✓

MIP	OBRB	PFINBTMB	RD	REC	RECTK	RECTK_6	RECTKFR6	RH	ROSFLUT	RT	SBCADDY	SBCADDYSM	SCPDWR	TBN	TD	TKP	TVR	UDBX	URT	VLSO	VTK	VWB	WS	WTR
✓			✓	✓	✓	✓	✓	✓	✓	✓	✓	✓	✓	✓	✓	✓	✓	✓	✓	✓	✓	✓	✓	✓

¹ Not available with 6" fluting.

Bath and Vanity Cabinets

BATH SINK BASE CABINET with SHELF, 30" HIGH, 21" DEEP

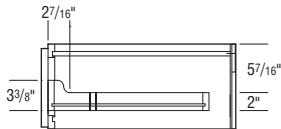
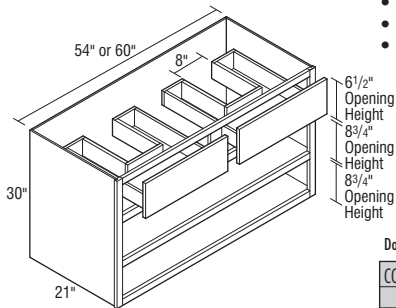
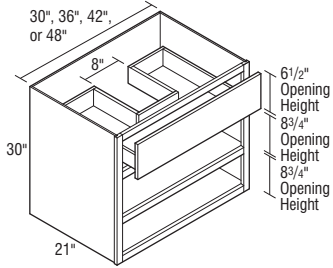

Top U-shaped drawer box has cascading side drawer feature.

	Cubic Feet	1	2	3	4	5	6	7
BCBC030	13.3	1621	1709	1768	1860	1961	2142	2323
BCBC036	15.9	1709	1800	1859	1957	2067	2255	2443
BCBC042	18.4	1801	1893	1957	2063	2176	2374	2572
BCBC048	20.9	1963	2068	2137	2252	2374	2593	2812
BCBC054	23.5	2110	2222	2299	2421	2554	2788	3022
BCBC060	26.0	2257	2377	2458	2588	2731	2981	3231

Notes below apply to all products in section above:

- Matching interior standard.
- No toekick standard.
- U-shaped drawer(s).
- Finished Ends standard.
- Fixed shelf behind 1 1/2" horizontal frame rail.
- Feet are optional, see page P•67 for more information.
- Sink bowl clearance to top of drawer box is 5 7/16".
- Touch-up kit (TUK) and Owner's Guide included.
- Blocking for use with legs pre-installed.

Door & Drawer Options

CC	CG	GAMD	HC	IFHG	MC	MD	MFO	PRMD	SGLPN	SHMD	SPLITDR	SPLITDRWS	TCG	TCP
----	----	------	----	------	----	----	-----	------	-------	------	---------	-----------	-----	-----

End Panel Options

AUTH	CSFPE	EXBK	EXDN	FFD	FL/FR	FPE	INTGE	IPE
✓	✓	✓		✓		✓	✓	✓

Custom Modification Options

ADD_SHLF	ADDTK	ADRW	BVR	CBO	CCO	CFNT0	CFP	CFRMO	CLIP	CMAT	CND	CSDGBK	DRWTK	EX	EX_OL	FD	FLUT	FTK	ID	IH	INVFRM	IW	
	✓			✓	✓	✓	✓	✓	✓	✓		✓		✓	✓	✓	✓	✓	✓	✓	✓	✓	✓

MIP	OBRB	PFINBTMB	RD	REC	RECTK	RECTK_6	RECTKFRT6	RH	ROSFLUT	RT	SBCADDY	SBCADDYSM	SCPDWR	TBN	TD	TKP	TVR	UBXB	URT	VLSO	VTK	VWB	WS	WTR
✓	✓									✓													✓	✓

U-SHAPED DRAWER ON SELECT BATH BASE CABINETS

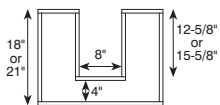

IH/RH availability charts starting on page G•40.
IW/RW availability charts starting on page G•46.

BATH SINK BASE CABINET with DOORS, 30" HIGH, 21" DEEP

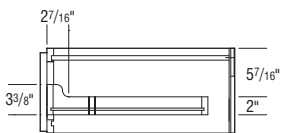
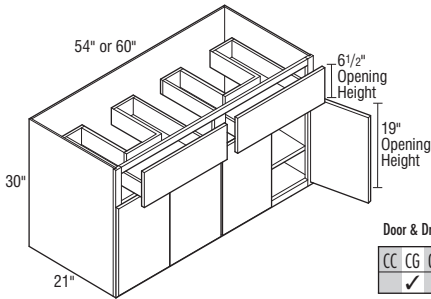
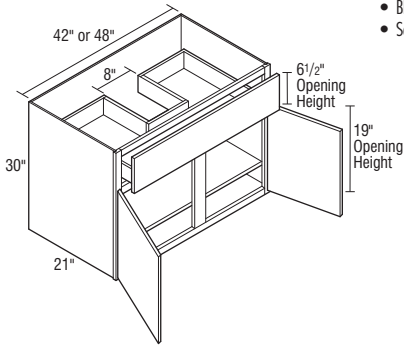
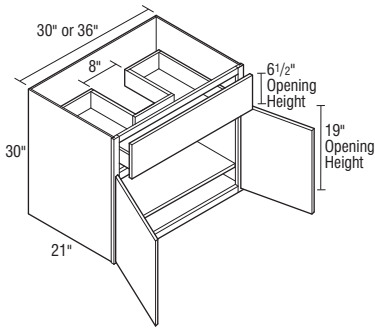

Top U-shaped drawer box has cascading side drawer feature.

	Cubic Feet	1	2	3	4	5	6	7
BCBCD30	13.3	1621	1709	1768	1860	1961	2142	2323
BCBCD36	15.9	1709	1800	1859	1957	2067	2255	2443
BCBCD42	18.4	1801	1893	1957	2063	2176	2374	2572
BCBCD48	20.9	1963	2068	2137	2252	2374	2593	2812
BCBCD54	23.5	2110	2222	2299	2421	2554	2788	3022
BCBCD60	26.0	2257	2377	2458	2588	2731	2981	3231

Notes below apply to all products in section above:

- No toekick standard.
- U-shaped drawer(s).
- Finished Ends standard.
- Sink bowl clearance to top of drawer box is 5 7/16".
- Touch-up kit (TUK) and Owner's Guide included.
- Blocking for use with legs pre-installed.
- See page P-67 for optional legs.

Door & Drawer Options

CC	CG	GAMD	HC	IFHG	MC	MD	MFO	PRMD	SGLPN	SHMD	SPLITDR	SPLITDRWS	TCG	TCP
✓	✓	✓	✓	✓	✓	✓	✓	✓	✓	✓	✓	✓	✓	✓

End Panel Options

AUTH	CSFPE	EXBK	EXDN	FFD	FL/FR	FPE	INTGE	IPE
✓	✓	✓	✓	✓	✓	✓	✓	✓

Custom Modification Options

ADD_SHLF	ADDTK	ADRW	BVR	CBO	CCO	CFNTO	CFP	CFRMO	CLIP	CMAT	CND	CSDGBK	DRWTK	EX	EX_QL	FD	FLUT ¹	FTK	ID	IH	INVFRM	IW	
✓	✓	✓	✓	✓	✓	✓	✓	✓	✓	✓	✓	✓	✓	✓	✓	✓	✓	✓	✓	✓	✓	✓	✓

MIP	OBRB	PFINBTMB	RD	REC	RECTK	RECTK_6	RECTKFR6	RH	ROSFLUT	RT	SBCADDY	SBCADDYSM	SCPDWR	TBN	TD	TKP	TVR	UDBX	URT	VLSO	VTK	VWB	WS	WTR
✓	✓	✓	✓	✓	✓	✓	✓	✓	✓	✓	✓	✓	✓	✓	✓	✓	✓	✓	✓	✓	✓	✓	✓	✓

¹ Not available with 6" fluting.

U-SHAPED DRAWER ON SELECT BATH BASE CABINETS

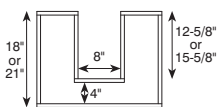

Bath and Vanity Cabinets

BATH HAMPER SINK BASE, 30" HIGH, 21" DEEP

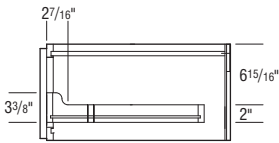
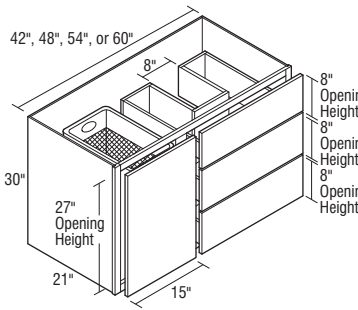

Top U-shaped drawer box has cascading side drawer feature.

Cubic Feet	1	2	3	4	5	6	7	
BCBH42D L or R	18.4	3323	3496	3618	3810	4019	4386	4753
BCBH48D L or R	20.9	3618	3805	3937	4146	4373	4774	5175
BCBH54D L or R	23.9	3909	4115	4256	4486	4731	5163	5595
BCBH60D L or R	26.0	4204	4426	4577	4822	5087	5552	6017

- Not available on Inset or Beaded Inset styles.
- Pull-out Hamper section has a constant 15" wide opening.
- Top two drawers are U-shaped.
- Finished Ends standard.
- Sink bowl clearance to top of drawer box is 7 3/32".
- Touch-up kit (TUK) and Owner's Guide included.
- Blocking for use with legs pre-installed.
- See page P•67 for optional legs.

Door & Drawer Options

CC	CG	GAMD	HC	IFHG	MC	MD	MFO	PRMD	SGLPN	SHMD	SPLITDR	SPLITDRWS	TCG	TCP
----	----	------	----	------	----	----	-----	------	-------	------	---------	-----------	-----	-----

End Panel Options

AUTH	CSFPE	EXBK	EXDN	FFD	FL/FR	FPE	INTGE	IPE
✓	✓	✓				✓	✓	

Custom Modification Options

ADD	SHLF	ADDTK	ADRW	BVR	CBO	CCO	CFNTD	CFP	CFRMO	CLIP	CMAT	CND	CSDGBK	DRWTK	EX	EX_OL	FD	FLUT	FTK	ID	IH	INVFRM	IW	
	✓				✓	✓	✓	✓	✓	✓			✓		✓	✓	✓	✓	✓	✓	✓			

MIP	ORRB	PFINBTMB	RD	REC	RECTK	RECTK_6	RECTKFRT6	RH	ROSFLUT	RT	SBCADDY	SBCADDYSM	SCPDWR	TBN	TD	TKP	TVR	UDBX	URT	VLSO	VTK	VWB	WS	WTR	
✓	✓									✓														✓	✓

¹ Not available with 6" fluting.

BATH WALL HUNG SINK DRAWER BASE, 18" HIGH, 21" DEEP

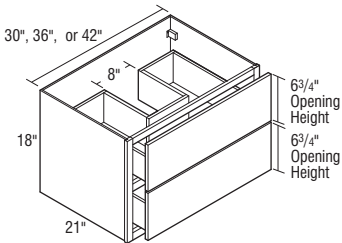

BCWHDB3018	8.2	2083	2191	2268	2388	2518	2751	2984
BCWHDB3618	9.8	2184	2298	2378	2506	2641	2884	3127
BCWHDB4218	11.4	2280	2400	2482	2617	2758	3011	3264

- Top drawer is U-shaped.
- Flush Finished Ends standard.
- Increased Depth to 24" is available.
- Wall hanging hardware included.
- Sink bowl clearance to top of drawer box is 5 11/16".
- Touch-up kit (TUK) and Owner's Guide included.
- Unit comes with an attached top for stability and a hole for the sink must be cut in the field.
- Unit must be securely fastened with sufficient type, quantity, and size of screws to all available wall studs and internal structural wall blocking placed between wall studs.
- Do not exceed loading of 25 lbs. / SF for countertop and sink.
- Do not exceed loading of 15 lbs. / SF for contents on shelves and/or in drawers.
- Avoid use of concrete or other heavy masonry countertops.
- Installation to be performed by qualified professionals only.
- Securing the end panels and face frame to the structural members available is recommended during installation. When ID is specified, the cabinet MUST be fastened to adjacent cabinets or to structural members on each side in addition to the back installation instructions.

Door & Drawer Options

CC	CG	GAMD	HC	IFHG	MC	MD	MFO	PRMD	SGLPN	SHMD	SPLITDR	SPLITDRWS	TCG	TCP
----	----	------	----	------	----	----	-----	------	-------	------	---------	-----------	-----	-----

End Panel Options

AUTH	CSFPE	EXBK	EXDN	FFD	FL/FR	FPE	INTGE	IPE
✓	✓	✓				✓	✓	

Custom Modification Options

ADD	SHLF	ADDTK	ADRW	BVR	CBO	CCO	CFNTD	CFP	CFRMO	CLIP	CMAT	CND	CSDGBK	DRWTK	EX	EX_OL	FD	FLUT	FTK	ID	IH	INVFRM	IW	
					✓	✓	✓	✓	✓	✓			✓		✓	✓	✓	✓	✓	✓	✓			

MIP	ORRB	PFINBTMB	RD	REC	RECTK	RECTK_6	RECTKFRT6	RH	ROSFLUT	RT	SBCADDY	SBCADDYSM	SCPDWR	TBN	TD	TKP	TVR	UDBX	URT	VLSO	VTK	VWB	WS	WTR	
✓										✓														✓	✓

U-SHAPED DRAWER ON SELECT BATH BASE CABINETS

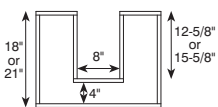

IH/RH availability charts starting on page G•40.
IW/RW availability charts starting on page G•46.

BATH WALL HUNG SINK DRAWER BASE, 21" HIGH, 21" DEEP

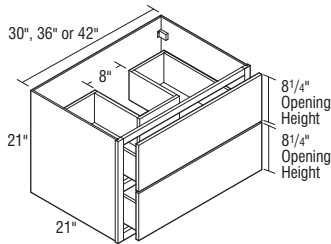

	Cubic Feet	1	2	3	4	5	6	7
BCWHDB3021	9.5	2148	2260	2337	2463	2594	2834	3074
BCWHDB3621	11.3	2249	2366	2448	2580	2719	2968	3217
BCWHDB4221	13.1	2346	2468	2554	2689	2834	3095	3356

- Top drawer is U-shaped.
- Flush Finished Ends standard.
- Increased Depth to 24" is available.
- Wall hanging hardware included.
- Sink bowl clearance to top of drawer box is 5 13/16".
- Touch-up kit (TUK) and Owner's Guide included.
- Unit comes with an attached top for stability and a hole for the sink must be cut in the field.
- Unit must be securely fastened with sufficient type, quantity, and size of screws to all available wall studs and internal structural wall blocking placed between wall studs.
- Do not exceed loading of 25 lbs. / SF for countertop and sink.
- Do not exceed loading of 15 lbs. / SF for contents on shelves and/or in drawers.
- Avoid use of concrete or other heavy masonry countertops.
- Installation to be performed by qualified professionals only.
- Securing the end panels and face frame to the structural members available is recommended during installation. When ID is specified, the cabinet **MUST** be fastened to adjacent cabinets or to structural members on each side in addition to the back installation instructions.

Door & Drawer Options

CC	CG	GAMD	HC	IFHG	MC	MD	MFO	PRMD	SGLPN	SHMD	SPLITDR	SPLITDRWS	TCG	TCP
----	----	------	----	------	----	----	-----	------	-------	------	---------	-----------	-----	-----

End Panel Options

AUTH	CSFPE	EXBK	EXDN	FFD	FL/FR	FPE	INTGE	IPE
✓	✓						✓	✓

Custom Modification Options

ADD_SHLF	ADDTK	ADRW	BVR	CBO	CCO	CFNTO	CFP	CFRMO	CLIP	CMAT	CND	CSDGBK	DRWTK	EX	EX_OL	FD	FLUT ¹	FTK	ID	IH	INVFRM	IW		
				✓	✓	✓	✓	✓	✓	✓		✓	✓	✓	✓	✓	✓	✓	✓					
MIP	OBRB	PFINBTMB	RD	REC	RECTK	RECTK_6	RECTKFR6	RH	ROSFLUT	RT	SBCADDY	SBCADDYSM	SCPDWR	TBN	TD	TKP	TVR	UDBX	URT	VLSO	VTK	VWB	WS	WTR
✓										✓								✓					✓	✓

¹ Not available with 6" fluting.

BATH WALL HUNG SINK DRAWER BASE, 24" HIGH, 21" DEEP

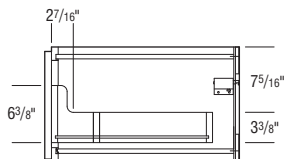
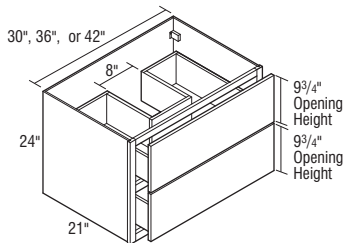

Top U-shaped drawer box has cascading side drawer feature.

	Cubic Feet	1	2	3	4	5	6	7
BCWHDB3024	10.9	2216	2331	2412	2542	2679	2925	3171
BCWHDB3624	12.9	2315	2437	2519	2656	2800	3058	3316
BCWHDB4224	14.8	2416	2542	2629	2770	2920	3189	3458

- Top drawer is U-shaped.
- Flush Finished Ends standard.
- Increased Depth to 24" is available.
- Wall hanging hardware included.
- Sink bowl clearance to top of drawer box is 7 5/16".
- Touch-up kit (TUK) and Owner's Guide included.
- Unit comes with an attached top for stability and a hole for the sink must be cut in the field.
- Unit must be securely fastened with sufficient type, quantity, and size of screws to all available wall studs and internal structural wall blocking placed between wall studs.
- Do not exceed loading of 25 lbs. / SF for countertop and sink.
- Do not exceed loading of 15 lbs. / SF for contents on shelves and/or in drawers.
- Avoid use of concrete or other heavy masonry countertops.
- Installation to be performed by qualified professionals only.
- Securing the end panels and face frame to the structural members available is recommended during installation. When ID is specified, the cabinet **MUST** be fastened to adjacent cabinets or to structural members on each side in addition to the back installation instructions.

Door & Drawer Options

CC	CG	GAMD	HC	IFHG	MC	MD	MFO	PRMD	SGLPN	SHMD	SPLITDR	SPLITDRWS	TCG	TCP
----	----	------	----	------	----	----	-----	------	-------	------	---------	-----------	-----	-----

End Panel Options

AUTH	CSFPE	EXBK	EXDN	FFD	FL/FR	FPE	INTGE	IPE
✓	✓						✓	✓

Custom Modification Options

ADD_SHLF	ADDTK	ADRW	BVR	CBO	CCO	CFNTO	CFP	CFRMO	CLIP	CMAT	CND	CSDGBK	DRWTK	EX	EX_OL	FD	FLUT	FTK	ID	IH	INVFRM	IW		
				✓	✓	✓	✓	✓	✓	✓		✓	✓	✓	✓	✓	✓	✓	✓					
MIP	OBRB	PFINBTMB	RD	REC	RECTK	RECTK_6	RECTKFR6	RH	ROSFLUT	RT	SBCADDY	SBCADDYSM	SCPDWR	TBN	TD	TKP	TVR	UDBX	URT	VLSO	VTK	VWB	WS	WTR
✓										✓								✓					✓	✓

U-SHAPED DRAWER ON SELECT BATH BASE CABINETS

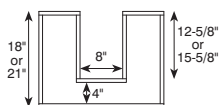

Bath and Vanity Cabinets

BATH WALL HUNG SINK with GROOMING PULL-OUT, 24" HIGH, 21" DEEP

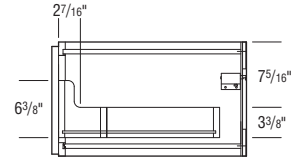
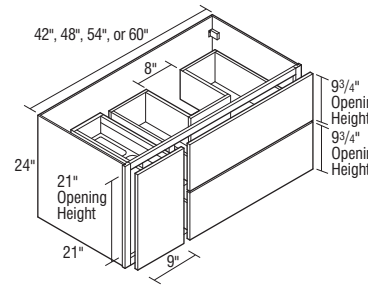

Top U-shaped drawer box has cascading side drawer feature.

Cubic Feet	1	2	3	4	5	6	7	
BCWHDBPO42D L or R	15.0	2764	2909	3009	3170	3345	3650	3955
BCWHDBPO48D L or R	17.1	2919	3071	3178	3347	3531	3853	4175
BCWHDBPO54D L or R	19.2	3073	3234	3347	3526	3719	4056	4393
BCWHDBPO60D L or R	21.2	3229	3397	3516	3700	3903	4260	4617

- Touch-up kit (TUK) and Owner's Guide included.
- Top drawer is U-shaped.
- Pull-out features two stainless steel bins, one round and one rectangular.
- Pull-out opening width remains a constant 9".
- Increased Depth to 24" is available.
- Flush Finished Ends standard.
- Wall hanging hardware included.
- Sink bowl clearance to top of drawer box is 7 5/16".
- Pull-out features Smart Stop.
- Unit must be securely fastened with sufficient type, quantity, and size of screws to all available wall studs and internal structural wall blocking placed between wall studs.
- Do not exceed loading of 25 lbs. / SF for countertop and sink.
- Do not exceed loading of 15 lbs. / SF for contents on shelves and/or in drawers.
- Avoid use of concrete or other heavy masonry countertops.
- Installation to be performed by qualified professionals only.
- Securing the end panels and face frame to the structural members available is recommended during installation. When ID is specified, the cabinet **MUST** be fastened to adjacent cabinets or to structural members on each side in addition to the back installation instructions.

Door & Drawer Options

CC	CG	GAMD	HC	IFHG	MC	MD	MFO	PRMD	SGLPN	SHMD	SPLITDR	SPLITDRWS	TCG	TCP
----	----	------	----	------	----	----	-----	------	-------	------	---------	-----------	-----	-----

End Panel Options

AUTH	CSFPE	EXBK	EXDN	FFD	FL/FR	FPE	INTGE	IPE
✓	✓	✓	✓	✓	✓	✓	✓	✓

Custom Modification Options

ADD_SHLF	ADDTK	ADRW	BVR	CBO	CCO	CFNTO	CFP	CFRMO	CLIP	CMAT	CND	CSDGBK	DRWTK	EX	EX_OL	FD	FLUT	FTK	ID	IH	INVFRM	IW
				✓	✓	✓		✓				✓		✓	✓		✓	✓	✓	✓		

MIP	ORRB	PFINBTMB	RD	REC	RECTK	RECTK_6	RECTKFR76	RH	ROSFLUT	RT	SBCADDY	SBCADDYSM	SCPDWR	TBN	TD	TKP	TVR	UBBX	URT	VLSO	VTK	VWB	WS	WTR
✓									✓									✓					✓	✓

U-SHAPED DRAWER ON SELECT BATH BASE CABINETS

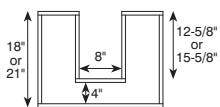

IH/RH availability charts starting on page G-40.
IW/RW availability charts starting on page G-46.

BATH DRAWER SINK BASE, 30" HIGH, 21" DEEP

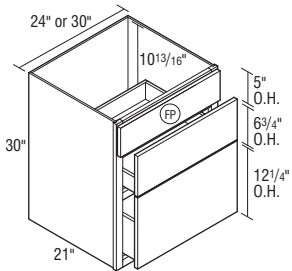

FP False Panel

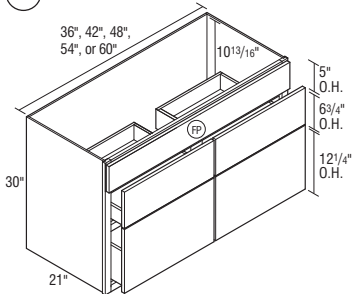

FP False Panel

	Cubic Feet	1	2	3	4	5	6	7
BCDB24	10.8	1490	1567	1620	1709	1802	1966	2130
BCDB30	13.3	1673	1759	1822	1918	2021	2209	2397
BCDB36	15.9	2017	2125	2197	2314	2441	2663	2885
BCDB42	18.4	2313	2432	2517	2652	2796	3056	3316
BCDB48	20.9	2608	2745	2837	2991	3153	3442	3731
BCDB54	23.5	2902	3053	3158	3326	3508	3831	4154
BCDB60	26.0	3196	3362	3479	3665	3866	4221	4576

Notes below apply to all products in section above:

- Top drawer is a false front.
- Finished Ends standard.
- Sink bowl clearance to top of drawer box is 10 13/16".
- Touch-up kit (TUK) and Owner's Guide included.
- Blocking for use with legs pre-installed.
- See page P●67 for optional legs.
- U-shaped drawers are not utilized in this cabinet.

Door & Drawer Options

CC	CG	GAMD	HC	IFHG	MC	MD	MFO	PRMD	SGLPN	SHMD	SPLITDR	SPLITDRWS	TCG	TCP
----	----	------	----	------	----	----	-----	------	-------	------	---------	-----------	-----	-----

End Panel Options

AUTH	CSFPE	EXBK	EXDN	FFD	FL/FR	FPE	INTGE	IPE
✓	✓	✓	✓	✓	✓	✓	✓	✓

Custom Modification Options

ADD	SHLF	ADDTK	ADRW	BVR	CBO	CCO	CFNTO	CFP	CFRMO	CLIP	CMAT	CND	CSDGBK	DRWTK	EX	EX_OL	FD	FLUT	FTK	ID	IH	INVFRM	IW	
		✓			✓	✓	✓	✓	✓	✓	✓	✓	✓	✓	✓	✓	✓	✓	✓	✓	✓	✓	✓	✓

MIP	OBRB	PFINBTMB	RD	REC	RECTK	RECTK_6	RECTKFR6	RH	ROSFLUT	RT	SBCADDDY	SBCADDDYSM	SCPDRW	TBN	TD	TKP	TVR	UDBX	URT	VLSO	VTK	VWB	WS	WTR
✓	✓		✓						✓														✓	✓

BATH TWO DRAWER SINK BASE, 30" HIGH, 21" DEEP

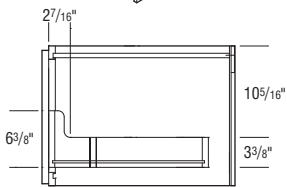
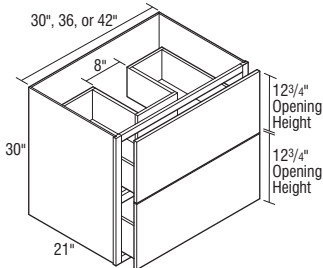

Top U-shaped drawer box has cascading side drawer feature.

	Cubic Feet	1	2	3	4	5	6	7
BC2DB30	12.4	1490	1567	1620	1709	1802	1966	2130
BC2DB36	14.8	1835	1929	1998	2104	2219	2422	2625
BC2DB42	17.1	2128	2240	2318	2441	2575	2812	3049

- Top drawer is U-shaped.
- Finished Ends standard.
- No toe-kick standard.
- Increased depth to 24" is available.
- Sink bowl clearance to top of drawer box is 10 5/16".
- Touch-up kit (TUK) and Owner's Guide included.
- Blocking for use with legs pre-installed.
- See page P●67 for optional legs.

Door & Drawer Options

CC	CG	GAMD	HC	IFHG	MC	MD	MFO	PRMD	SGLPN	SHMD	SPLITDR	SPLITDRWS	TCG	TCP
----	----	------	----	------	----	----	-----	------	-------	------	---------	-----------	-----	-----

End Panel Options

AUTH	CSFPE	EXBK	EXDN	FFD	FL/FR	FPE	INTGE	IPE
✓	✓	✓	✓	✓	✓	✓	✓	✓

Custom Modification Options

ADD	SHLF	ADDTK	ADRW	BVR	CBO	CCO	CFNTO	CFP	CFRMO	CLIP	CMAT	CND	CSDGBK	DRWTK	EX	EX_OL	FD	FLUT	FTK	ID	IH	INVFRM	IW	
		✓			✓	✓	✓	✓	✓	✓	✓	✓	✓	✓	✓	✓	✓	✓	✓	✓	✓	✓	✓	✓

MIP	OBRB	PFINBTMB	RD	REC	RECTK	RECTK_6	RECTKFR6	RH	ROSFLUT	RT	SBCADDDY	SBCADDDYSM	SCPDRW	TBN	TD	TKP	TVR	UDBX	URT	VLSO	VTK	VWB	WS	WTR
✓	✓		✓						✓														✓	✓

U-SHAPED DRAWER ON SELECT BATH BASE CABINETS

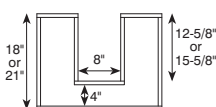

Bath and Vanity Cabinets

BATH DRAWER SINK VANITY, 15 1/2" HIGH, 21" DEEP

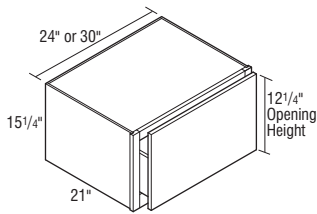

	Cubic Feet	1	2	3	4	5	6	7
BCDRW24	5.5	1600	1683	1742	1834	1934	2110	2286
BCDRW30	6.8	1710	1801	1860	1958	2068	2256	2444

- Finished Ends standard.
- No toe-kick standard.
- Blocking for use with legs pre-installed.
- See page P•67 for optional legs.

Door & Drawer Options

CC	CG	GAMD	HC	IFHG	MC	MD	MFO	PRMD	SGLPN	SHMD	SPLITDR	SPLITDRWS	TCG	TCP
✓	✓	✓	✓	✓	✓	✓	✓	✓	✓	✓	✓	✓	✓	✓

End Panel Options

AUTH	CSFPE	EXBK	EXDN	FFD	FL/FR	FPE	INTGE	IPE
✓	✓	✓	✓	✓	✓	✓	✓	✓

Custom Modification Options

ADD	SHLF	ADDTK	ADRW	BVR	CBO	CCO	CFNTD	CFP	CFRMO	CLIP	CMAT	CND	CSDGBK	DRWTK	EX	EX_OL	FD	FLUT	FTK	ID	IH	INVFRM	IW	
✓	✓	✓	✓	✓	✓	✓	✓	✓	✓	✓	✓	✓	✓	✓	✓	✓	✓	✓	✓	✓	✓	✓	✓	✓

MIP	OBRB	PFINBTMB	RD	REC	RECTK	RECTK_6	RECTKFT6	RH	ROSLUT	RT	SBCADDY	SBCADDYSM	SCPDWR	TBN	TD	TKP	TVR	UBBX	URT	VLSO	VTK	VWB	WS	WTR	
✓	✓	✓	✓	✓	✓	✓	✓	✓	✓	✓	✓	✓	✓	✓	✓	✓	✓	✓	✓	✓	✓	✓	✓	✓	✓

BATH DRAWER SINK VANITY PLATFORM

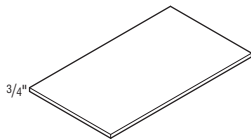

BCPLATFORM	—	65	65	65	65	65	65	65
-------------------	---	----	----	----	----	----	----	----

- Specify depth and length.
- 3/4" thick.
- Front, left, and right edges banded.
- Priced per square-foot.

Modifications
Are Not
Available

BATH DROP TRAY SINK BASE, 30" HIGH, 21" DEEP

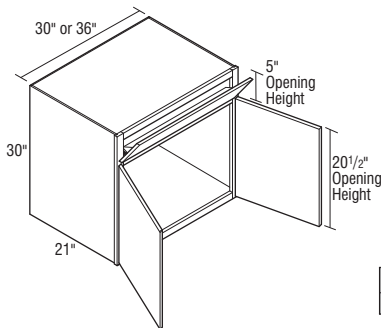

BCBDT30NTK	9.9	1902	2003	2070	2182	2303	2512	2721
BCBDT36NTK	11.8	2003	2105	2179	2296	2420	2642	2864

- No shelf included.
- Finished Ends standard.
- Blocking for use with legs pre-installed.
- See page P•67 for optional legs.
- One drawer front with one 1 11/16" deep stainless steel Tilt-out Tray attached.

Door & Drawer Options

CC	CG	GAMD	HC	IFHG	MC	MD	MFO	PRMD	SGLPN	SHMD	SPLITDR	SPLITDRWS	TCG	TCP
✓	✓	✓	✓	✓	✓	✓	✓	✓	✓	✓	✓	✓	✓	✓

End Panel Options

AUTH	CSFPE	EXBK	EXDN	FFD	FL/FR	FPE	INTGE	IPE
✓	✓	✓	✓	✓	✓	✓	✓	✓

Custom Modification Options

ADD	SHLF	ADDTK	ADRW	BVR	CBO	CCO	CFNTD	CFP	CFRMO	CLIP	CMAT	CND	CSDGBK	DRWTK	EX	EX_OL	FD	FLUT	FTK	ID	IH	INVFRM	IW	
✓	✓	✓	✓	✓	✓	✓	✓	✓	✓	✓	✓	✓	✓	✓	✓	✓	✓	✓	✓	✓	✓	✓	✓	✓

MIP	OBRB	PFINBTMB	RD	REC	RECTK	RECTK_6	RECTKFT6	RH	ROSLUT	RT	SBCADDY	SBCADDYSM	SCPDWR	TBN	TD	TKP	TVR	UBBX	URT	VLSO	VTK	VWB	WS	WTR	
✓	✓	✓	✓	✓	✓	✓	✓	✓	✓	✓	✓	✓	✓	✓	✓	✓	✓	✓	✓	✓	✓	✓	✓	✓	✓

IH/RH availability charts starting on page G•40.
IW/RW availability charts starting on page G•46.

BATH STORAGE TOWER, 49 1/2", 55 1/2", or 61 1/2" HIGH, 21" DEEP

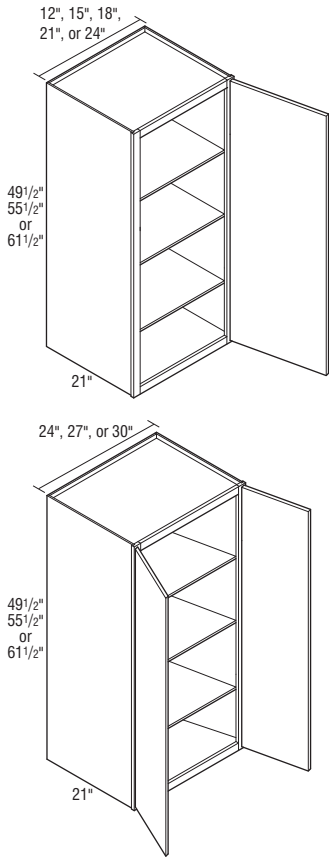

	Cubic Feet	1	2	3	4	5	6	7
BCST1249.5 L or R	9.1	1877	1977	2045	2154	2271	2479	2687
BCST1549.5 L or R	11.2	1955	2058	2128	2241	2364	2582	2800
BCST1849.5 L or R	13.2	2021	2128	2203	2319	2448	2672	2896
BCST2149.5 L or R	15.2	2101	2212	2284	2410	2542	2774	3006
BCST2449.5 L or R	17.3	2168	2281	2362	2486	2622	2864	3106
BCST2449.5	17.3	2464	2591	2681	2824	2978	3251	3524
BCST2749.5	19.3	3031	3187	3299	3475	3666	4001	4336
BCST3049.5	21.3	3214	3383	3499	3688	3887	4245	4603
• Three adjustable shelves								
BCST1255.5 L or R	10.2	2062	2169	2245	2363	2492	2721	2950
BCST1555.5 L or R	12.5	2138	2252	2329	2453	2587	2824	3061
BCST1855.5 L or R	14.7	2208	2323	2401	2530	2668	2913	3158
BCST2155.5 L or R	17.0	2283	2406	2486	2619	2763	3018	3273
BCST2455.5 L or R	19.3	2352	2476	2560	2697	2847	3109	3371
BCST2455.5	19.3	2646	2786	2882	3034	3201	3495	3789
BCST2755.5	21.5	3214	3383	3499	3688	3887	4245	4603
BCST3055.5	23.8	3398	3576	3699	3897	4111	4489	4867
BCST1261.5 L or R	11.3	2209	2325	2404	2532	2672	2917	3162
BCST1561.5 L or R	13.8	2471	2599	2689	2831	2989	3261	3533
BCST1861.5 L or R	16.3	2539	2672	2763	2911	3068	3351	3634
BCST2161.5 L or R	18.8	2617	2753	2848	2999	3165	3452	3739
BCST2461.5 L or R	21.3	2684	2824	2920	3078	3245	3543	3841
BCST2461.5	21.3	2977	3134	3240	3415	3601	3932	4263
BCST2761.5	23.8	3547	3731	3860	4068	4288	4681	5074
BCST3061.5	26.3	3730	3925	4058	4277	4510	4924	5338

• Four adjustable shelves.

Notes below apply to all products in section above:

- No toe-kick standard.
- Finished Ends standard.
- Glass shelf kit available, see page S-7.
- Legs sold separately, see page P-67 for options.
- Cabinets use standard wall cabinet construction. Additional materials may be required for field installation if top of cabinet will be visible.
- Blocking for use with legs pre-installed.

Door & Drawer Options

CC	CG	GAMD	HC	IFHG	MC	MD	MFO	PRMD	SGLPN	SHMD	SPLITDR ¹	SPLITDRWS	TCG ²	TCP ²
✓	✓	✓	✓	✓	✓	✓	✓	✓	✓	✓	✓	✓	✓	✓

End Panel Options

AUTH	CSFPE	EXBK	EXDN	FFD	FL/FR	FPE	INTGE	IPE
✓	✓	✓	✓	✓	✓	✓	✓	✓

Custom Modification Options

ADD	SHLF	ADDTK	ADRW	BVR	CBO	CCO	CFNTO	CFP	CFRMO	CLIP	CMAT	CND	CSDGBK	DRWTK	EX	EX_OL	FD	FLUT ³	FTK	ID	IH	INVERM	IW	
✓	✓	✓	✓	✓	✓	✓	✓	✓	✓	✓	✓	✓	✓	✓	✓	✓	✓	✓	✓	✓	✓	✓	✓	✓

MIP	OBRB	PFINBTMB	RD	REC	RECTK	RECTK_6	RECTKRT6	RH	ROSLUT	RT	SBCADDY	SBCADDYSM	SCPDRW	TBN	TD	TKP	TVR ⁴	UDBX	URT	VLSO	VTK	VWB	WS	WTR
✓	✓	✓	✓	✓	✓	✓	✓	✓	✓	✓	✓	✓	✓	✓	✓	✓	✓	✓	✓	✓	✓	✓	✓	✓

¹ Only available on 24" (2 doors)-30" wide.
² Only available on 24" (2 doors wide) wide except not available on 61 1/2" high.
³ Not available with 6" fluting.
⁴ Only available on TVRVV.

Bath and Vanity Cabinets

BATH STORAGE TOWER SINGLE DRAWER, 49 1/2", 55 1/2", or 61 1/2" HIGH, 21" DEEP

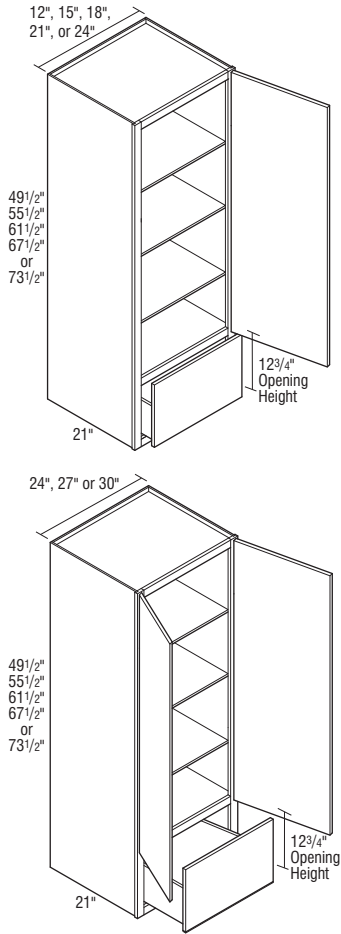

	Cubic Feet	1	2	3	4	5	6	7	
BCSTDRW1249.5 L or R	9.1	1987	2091	2163	2278	2404	2624	2844	
BCSTDRW1549.5 L or R	11.2	2067	2175	2249	2369	2498	2727	2956	
BCSTDRW1849.5 L or R	13.2	2132	2245	2323	2448	2581	2818	3055	
BCSTDRW2149.5 L or R	15.2	2212	2327	2409	2537	2676	2919	3162	
BCSTDRW2449.5 L or R	17.3	2278	2399	2481	2614	2757	3009	3261	
• Two adjustable shelves.									
BCSTDRW2449.5	17.3	2574	2709	2800	2951	3114	3397	3680	
BCSTDRW2749.5	19.3	3142	3305	3420	3601	3799	4146	4493	
BCSTDRW3049.5	21.3	3325	3499	3620	3812	4021	4390	4759	
• Two adjustable shelves.									
BCSTDRW1255.5 L or R	10.2	2170	2283	2364	2489	2626	2866	3106	
BCSTDRW1555.5 L or R	12.5	2249	2367	2449	2578	2721	2970	3219	
BCSTDRW1855.5 L or R	14.7	2318	2439	2522	2657	2801	3059	3317	
BCSTDRW2155.5 L or R	17.0	2396	2519	2608	2747	2896	3162	3428	
BCSTDRW2455.5 L or R	19.3	2464	2591	2681	2824	2978	3251	3524	
• Three adjustable shelves.									
BCSTDRW2455.5	19.3	2758	2902	3002	3162	3334	3639	3944	
BCSTDRW2755.5	21.5	3325	3499	3620	3812	4021	4390	4759	
BCSTDRW3055.5	23.8	3508	3693	3820	4024	4245	4634	5023	
• Three adjustable shelves.									
BCSTDRW1261.5 L or R	11.3	2319	2441	2524	2658	2804	3062	3320	
BCSTDRW1561.5 L or R	13.8	2581	2716	2810	2961	3121	3408	3695	
BCSTDRW1861.5 L or R	16.3	2649	2788	2884	3035	3203	3496	3789	
BCSTDRW2161.5 L or R	18.8	2726	2869	2967	3126	3296	3599	3902	
BCSTDRW2461.5 L or R	21.3	2794	2940	3041	3205	3381	3689	3997	
• Three adjustable shelves.									
BCSTDRW2461.5	21.3	3088	3250	3361	3540	3735	4077	4419	
BCSTDRW2761.5	23.8	3657	3847	3982	4192	4422	4827	5232	
BCSTDRW3061.5	26.3	3839	4041	4179	4403	4644	5070	5496	

Notes below apply to all products in section above:

- Finished Ends standard.
- No toekick standard.
- Glass shelf kit available, see page S•7.
- Legs sold separately; see page P•67 for options.
- Cabinets use standard wall cabinet construction. Additional materials may be required for field installation if top of cabinet will be visible.
- Blocking for use with legs pre-installed.

Door & Drawer Options

CC	CG	GAMD	HC	IFHG	MC	MD	MFO	PRMD	SGLPN	SHMD	SPLITDR	SPLITDRWS	TCG	TCP
✓	✓	✓	✓	✓	✓	✓	✓	✓						

End Panel Options

AUTH	CSFPE	EXBK	EXDN	FFD	FL/FR	FPE	INTGE	IPE
✓	✓	✓	✓	✓	✓	✓	✓	✓

Custom Modification Options

ADD	SHLF	ADTK	ADRW	BVR	CBO	CCO	CFNT0	CFP	CFRMO	CLIP ¹	CMAT	CND	CSDGBK	DRWTK	EX	EX_OL	FD	FLUT ²	FTK	ID	IH	INVFRM	IW	
✓																								

MIP	OBRB	PFINBTMB	RD	REC	RECTK	RECTK_6	RECTKFR16	RH	ROSFLUT	RT	SBCADDY	SBCADDYSM	SCDRW	TBN	TD	TKP	TVR ³	UDBX	URT	VLSO	VTK	VWB	WS	WTR
✓	✓	✓	✓	✓	✓	✓	✓	✓	✓	✓	✓	✓	✓	✓	✓	✓	✓	✓	✓	✓	✓	✓	✓	✓

¹ Not available on 12" wide.

² Not available with 6" fluting.

³ TVRAV and style B-L not available on 12" wide.

IH/RH availability charts starting on page G•40.
IW/RW availability charts starting on page G•46.

BATH STORAGE TOWER SINGLE DRAWER, 67 1/2" or 73 1/2" HIGH, 21" DEEP

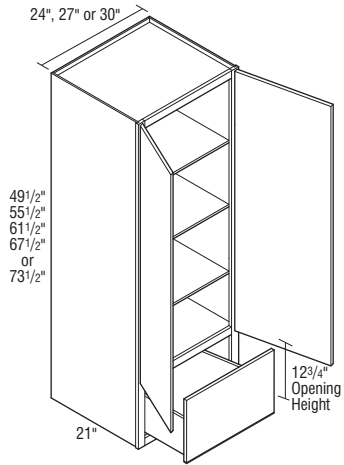
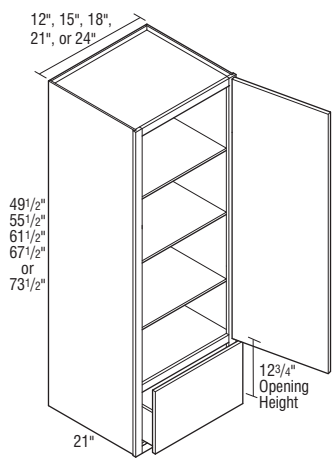

	Cubic Feet	1	2	3	4	5	6	7
BCSTDRW1267.5 L or R	12.3	2428	2556	2645	2786	2936	3207	3478
BCSTDRW1567.5 L or R	15.0	2690	2831	2930	3085	3256	3554	3852
BCSTDRW1867.5 L or R	17.8	2759	2903	3003	3165	3335	3640	3945
BCSTDRW2167.5 L or R	20.5	2836	2986	3088	3251	3430	3746	4062
BCSTDRW2467.5 L or R	23.2	2904	3058	3162	3329	3515	3834	4153
• Four adjustable shelves.								
BCSTDRW2467.5	23.2	3198	3365	3481	3667	3869	4223	4577
BCSTDRW2767.5	26.0	3767	3965	4101	4320	4554	4975	5396
BCSTDRW3067.5	28.7	3951	4158	4299	4530	4778	5213	5648
• Four adjustable shelves.								
BCSTDRW1273.5 L or R	13.4	2540	2673	2764	2912	3069	3352	3635
BCSTDRW1573.5 L or R	16.3	2800	2946	3050	3212	3388	3698	4008
BCSTDRW1873.5 L or R	19.3	2869	3021	3122	3289	3469	3786	4103
BCSTDRW2173.5 L or R	22.3	2946	3100	3210	3381	3564	3892	4220
BCSTDRW2473.5 L or R	25.2	3015	3173	3282	3458	3646	3982	4318
• Four adjustable shelves.								
BCSTDRW2473.5	25.2	3310	3484	3601	3795	4001	4370	4739
BCSTDRW2773.5	28.2	3876	4079	4222	4445	4688	5120	5552
BCSTDRW3073.5	31.2	4058	4274	4421	4656	4912	5362	5812
• Four adjustable shelves.								

Notes below apply to all products in section above:

- Finished Ends standard.
- No toe-kick standard.
- Glass shelf kit available, see page S-7.
- Legs sold separately; see page P-67 for options.
- Cabinets use standard wall cabinet construction. Additional materials may be required for field installation if top of cabinet will be visible.
- Blocking for use with legs pre-installed.

Door & Drawer Options

CC	CG	GAMD	HC	IFHG	MC	MD ¹	MFO	PRMD	SGLPN	SHMD	SPLITDR	SPLITDRWS	TCG	TCP
✓	✓		✓	✓	✓	✓	✓							

End Panel Options

AUTH	CSFPE	EXBK	EXDN	FFD	FL/FR	FPE	INTGE	IPE
✓	✓	✓		✓		✓	✓	✓

Custom Modification Options

ADD_SHLF	ADDTK	ADRW	BVR	CBO	CCO	CFNTO	CFP	CFRMO	CLIP ²	CMAT	CND	CSDGBK	DRWTK	EX	EX_OL	FD	FLUT ³	FTK	ID	IH	INVERM	IW		
	✓			✓	✓	✓		✓	✓	✓	✓	✓		✓	✓	✓	✓	✓	✓	✓	✓	✓		
MIP	OBRB	PFINBTMB	RD	REC	RECTK	RECTK_6	RECTKFR76	RH	ROSLUT	RT	SBCADDY	SBCADDYSM	SCPDRW	TBN	TD	TKP	TVR ⁴	UDBX	URT	VLSD	VTK	VWB	WS	WTR
✓	✓		✓								✓	✓					✓						✓	✓

¹ Only available on 12"-21" wide on the 67 1/2" high.
² Not available on 12" wide.
³ Not available with 6" fluting.
⁴ TVRAV and style B-L not available on 12" wide.

Bath and Vanity Cabinets

BATH STORAGE TOWER DOUBLE DRAWER, 79 1/2", 85 1/2", or 91 1/2" HIGH, 21" DEEP

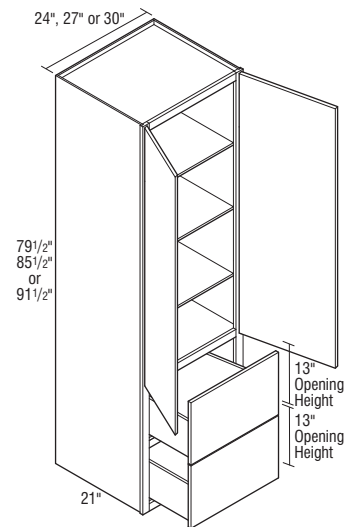
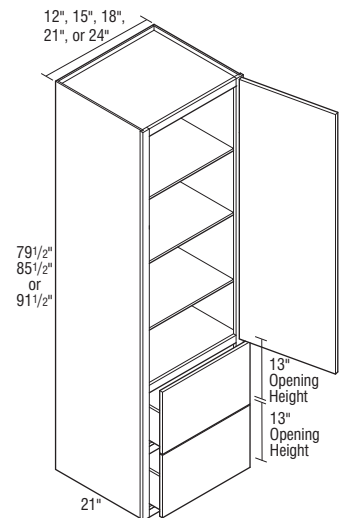

	Cubic Feet	1	2	3	4	5	6	7
BCSTDRW1279.5 L or R	14.4	2650	2789	2885	3037	3205	3497	3789
BCSTDRW1579.5 L or R	17.6	2912	3064	3170	3339	3522	3843	4164
BCSTDRW1879.5 L or R	20.8	2978	3136	3243	3417	3602	3933	4264
BCSTDRW2179.5 L or R	24.0	3058	3217	3328	3504	3697	4037	4377
BCSTDRW2479.5 L or R	27.2	3125	3288	3400	3585	3780	4127	4474
BCSTDRW2479.5	27.2	3420	3597	3724	3922	4135	4515	4895
BCSTDRW2779.5	30.4	3987	4196	4340	4571	4822	5265	5708
BCSTDRW3079.5	33.6	4170	4390	4539	4783	5045	5507	5969
BCSTDRW1285.5 L or R	15.5	2761	2904	3004	3166	3337	3643	3949
BCSTDRW1585.5 L or R	18.9	3024	3180	3289	3465	3655	3989	4323
BCSTDRW1885.5 L or R	22.3	3090	3251	3362	3543	3736	4079	4422
BCSTDRW2185.5 L or R	25.8	3169	3331	3448	3633	3831	4180	4529
BCSTDRW2485.5 L or R	29.2	3235	3406	3522	3709	3913	4271	4629
BCSTDRW2485.5	29.2	3529	3714	3842	4046	4267	4659	5051
BCSTDRW2785.5	32.7	4098	4313	4461	4699	4954	5409	5864
BCSTDRW3085.5	36.1	4282	4505	4661	4908	5179	5653	6127
BCSTDRW1291.5 L or R	16.5	2871	3023	3125	3291	3470	3790	4110
BCSTDRW1591.5 L or R	20.2	3131	3296	3411	3592	3789	4135	4481
BCSTDRW1891.5 L or R	23.9	3200	3367	3484	3668	3870	4226	4582
BCSTDRW2191.5 L or R	27.5	3277	3449	3568	3759	3965	4327	4689
BCSTDRW2491.5 L or R	31.2	3347	3521	3640	3837	4046	4419	4792
BCSTDRW2491.5	31.2	3639	3831	3964	4174	4402	4805	5208
BCSTDRW2791.5	34.9	4207	4430	4580	4826	5090	5554	6018
BCSTDRW3091.5	38.6	4392	4623	4780	5036	5311	5798	6285

- Four adjustable shelves.
- Finished Ends standard.
- No toekick standard.
- Glass shelf kit available, see page S•7.
- Legs sold separately; see page P•67 for options.
- Cabinets use standard wall cabinet construction. Additional materials may be required for field installation if top of cabinet will be visible.
- Blocking for use with legs pre-installed.

Door & Drawer Options

CC	CG	GAMD	HC	IFHG	MC	MD	MFO	PRMD	SGLPN	SHMD	SPLITDR	SPLITDRWS	TCG	TCP
✓				✓			✓							

End Panel Options

AUTH	CSFPE	EXBK	EXDN	FFD	FL/FR	FPE	INTGE	IPE
✓	✓	✓		✓		✓	✓	✓

Custom Modification Options

ADD	SHLF	ADTK	ADRW	BVR	CBO	CCO	CFNT0	CFP	CFRMO	CLIP ¹	CMAT	CND	CSDGBK	DRWTK	EX	EX_OL	FD	FLUT ²	FTK	ID	IH	INVFRM	IW	
	✓					✓	✓	✓	✓	✓	✓	✓	✓	✓	✓	✓	✓	✓	✓	✓	✓	✓	✓	✓

MIP	OBRB	PFINBTMB	RD	REC	RECTK	RECTK_6	RECTKFR6	RH	ROSLUT ³	RT	SBCADDY	SBCADDYSM	SCPDWR	TBN	TD	TKP	TVR ⁴	UDBX	URT	VL50	VTK	VWB	WS	WTR
✓	✓	✓	✓	✓					✓	✓							✓	✓					✓	✓

¹ Not available on 12" wide.
² Not available with 3091.5 version or with 6" fluting.
³ Not available with 3091.5 version.
⁴ TVRAV and style B-L not available on 12" wide.

IH/RH availability charts starting on page G•40.
 IW/RW availability charts starting on page G•46.

BATH TANK TOPPER OPEN SHELF, 30" or 36" HIGH, 8" DEEP

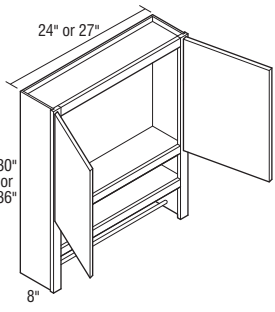

	Cubic Feet	1	2	3	4	5	6	7
BCTTOS2430	4.6	1776	1871	1934	2037	2152	2347	2542
BCTTOS2436	5.4	1902	2003	2070	2182	2303	2512	2721
BCTTOS2730	5.1	1853	1949	2015	2123	2239	2444	2649
BCTTOS2736	6.0	1954	2057	2127	2240	2363	2578	2793

- Includes one shelf.
- Flush Panel Ends standard.
- Matching Interior standard.
- Wooden Towel Bar standard. Option to select Nickel, see modification TBN for more information.

Door & Drawer Options

CC	CG	GAMD	HC	IFHG	MC	MD	MFO	PRMD	SGLPN	SHMD	SPLITDR	SPLITDRWS	TCG	TCP
✓				✓			✓							

End Panel Options

AUTH	CSFPE	EXBK	EXDN	FFD	FL/FR	FPE	INTGE	IPE
		✓	✓		✓			

Custom Modification Options

ADD_SHLF	ADDTK	ADRW	BVR	CBO	CCO	CFNT0	CFP	CFRMO	CLIP	CMAT	CND	CSDGBK	DRWTK	EX	EX_OL	FD	FLUT	FTK	ID	IH	INVERM	IW	
				✓	✓	✓		✓				✓		✓	✓								

MIP	OBRB	PFINBTMB	RD	REC	RECTK	RECTK_6	RECTKFR6	RH	ROSFLUT	RT	SBCADDY	SBCADDYSM	SCPDWR	TBN	TD	TKP	TVR	UDBX	URT	VLSO	VTK	VVB	WS	WTR
✓														✓									✓	✓

BATH TANK TOPPER, 30" or 36" HIGH, 8" DEEP

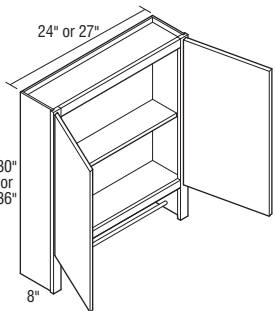

BCTT2430	4.6	1924	2026	2095	2208	2327	2542	2757
BCTT2436	5.4	2049	2158	2230	2350	2479	2708	2937
BCTT2730	5.1	2000	2102	2176	2291	2417	2639	2861
BCTT2736	6.0	2072	2180	2255	2374	2507	2733	2959

- Two adjustable shelves.
- Flush Panel Ends standard.
- Matching Interior standard.
- Wooden Towel Bar standard. Option to select Nickel Aluminum, see modification TBN for more information.

Door & Drawer Options

CC	CG	GAMD	HC	IFHG	MC	MD	MFO	PRMD	SGLPN	SHMD	SPLITDR	SPLITDRWS	TCG	TCP
✓				✓			✓							

End Panel Options

AUTH	CSFPE	EXBK	EXDN	FFD	FL/FR	FPE	INTGE	IPE
		✓	✓		✓			

Custom Modification Options

ADD_SHLF	ADDTK	ADRW	BVR	CBO	CCO	CFNT0	CFP	CFRMO	CLIP	CMAT	CND	CSDGBK	DRWTK	EX	EX_OL	FD	FLUT	FTK	ID	IH	INVERM	IW	
				✓	✓	✓		✓				✓		✓	✓								

MIP	OBRB	PFINBTMB	RD	REC	RECTK	RECTK_6	RECTKFR6	RH	ROSFLUT	RT	SBCADDY	SBCADDYSM	SCPDWR	TBN	TD	TKP	TVR	UDBX	URT	VLSO	VTK	VVB	WS	WTR
✓														✓									✓	✓

BATH TANK TOPPER OPEN SHELF, 30" or 36" HIGH, 8" DEEP

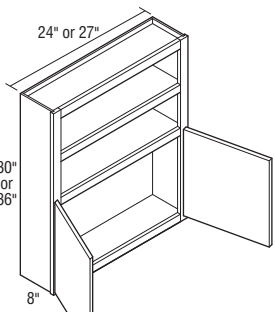

BCTTOSM2430	4.6	1776	1871	1934	2037	2152	2347	2542
BCTTOSM2436	5.4	1902	2003	2070	2182	2303	2512	2721
BCTTOSM2730	5.1	1853	1949	2015	2123	2239	2444	2649
BCTTOSM2736	6.0	1954	2057	2127	2240	2363	2578	2793

- 36" high units will include one adjustable shelf.
- Matching Interior standard.
- Flush Panel Ends standard.

Door & Drawer Options

CC	CG	GAMD	HC	IFHG	MC	MD	MFO	PRMD	SGLPN	SHMD	SPLITDR	SPLITDRWS	TCG	TCP
✓				✓			✓							

End Panel Options

AUTH	CSFPE	EXBK	EXDN	FFD	FL/FR	FPE	INTGE	IPE
		✓	✓		✓			

Custom Modification Options

ADD_SHLF	ADDTK	ADRW	BVR	CBO	CCO	CFNT0	CFP	CFRMO	CLIP	CMAT	CND	CSDGBK	DRWTK	EX	EX_OL	FD	FLUT	FTK	ID	IH	INVERM	IW	
				✓	✓	✓		✓				✓		✓	✓								

MIP	OBRB	PFINBTMB	RD	REC	RECTK	RECTK_6	RECTKFR6	RH	ROSFLUT	RT	SBCADDY	SBCADDYSM	SCPDWR	TBN	TD	TKP	TVR	UDBX	URT	VLSO	VTK	VVB	WS	WTR
✓			✓																				✓	✓

Kits and Hardware

	Cubic Feet	1	2	3	4	5	6	7
BATH FRAMED WALL MIRROR, 3/4" DEEP BCFWM	—	244	244	244	244	244	244	244

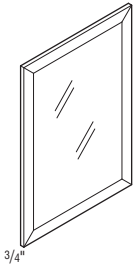

- 1/8" thick mirror.
- Mirror to be dropped shipped separately from mirror frame.
- Specify width x height.
- Maximum width is 60".
- Maximum height is 60".
- Maximum width or height is 36" when opposite width or height exceeds 36".
- Priced per square foot.

Modifications
Are Not
Available

BATH CHANNEL WALL MIRROR, 1 1/2" DEEP

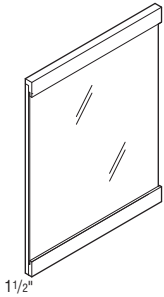

	Cubic Feet	1	2	3	4	5	6	7
BATH CHANNEL WALL MIRROR, 1 1/2" DEEP BCCWM	—	221	221	221	221	221	221	221

- 1/4" thick mirror.
- Mirror to be dropped shipped separately from mirror frame.
- Installation instructions included.
- Specify width x height.
- Maximum width is 96".
- Maximum height is 96".
- Maximum width or height is 48" when opposite width or height exceeds 48".
- Priced per square foot.

Modifications
Are Not
Available

BATH MIRROR WALL PULL-OUT, 32 3/4" HIGH, 4 1/2" DEEP

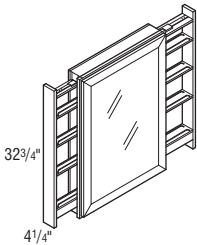

VMP2432.5	3.0	2613	2749	2843	2994	3158	3448	3738
VMP3032.5	3.7	2729	2874	2971	3128	3301	3602	3903

- Three adjustable shelves in each pull-out section.
- Installation instructions included.
- Mirror to be dropped shipped separately from mirror frame.
- Mirror frame will match door style.
- Pull-outs extend 10 3/8" on each side. VMP2432.5 open width is 44 3/4". VMP3032.5 open width is 50 3/4".
- Not available with Inset and Beaded Inset.

Modifications
Are Not
Available

BATH HAMPER KIT, 21" HIGH, 19 3/4" DEEP

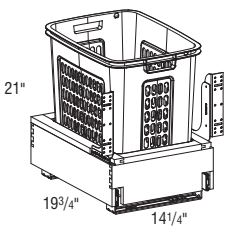

HAMPERKIT5	4.6	817	817	817	817	817	817	817
-------------------	-----	-----	-----	-----	-----	-----	-----	-----

- For 18" wide base cabinet, 15" wide opening.
- Not available on Inset or Beaded Inset 21" deep cabinets.
- Available for installation in 21" or 24" deep cabinets.

Modifications
Are Not
Available

IH/RH availability charts starting on page G•40.
IW/RW availability charts starting on page G•46.

BATH GROOMING PULL-OUT KIT, 20 1/2" HIGH, 19" DEEP

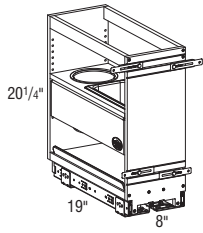

GPOKIT

- For 12" wide base cabinet, 9" wide opening.
- Available for installation in 21" or 24" deep cabinets.
- Pull-out features two stainless steel bins, one round and one rectangular.
- Pull-out features Smart Stop.

Modifications
Are Not
Available

Cubic Feet	1	2	3	4	5	6	7
2.6	570	570	570	570	570	570	570

BATH FEET

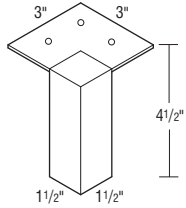

FOOTMETALSQ

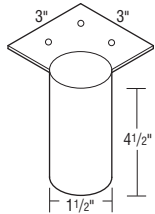

FOOTMETALRD

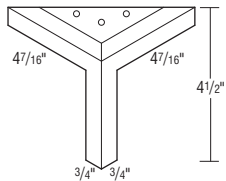

FOOTMETALNG

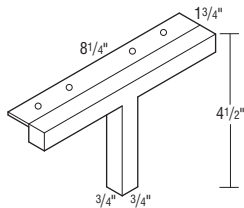

FOOTMETALNGT

FOOTMETALSQBS	0.5	298	298	298	298	298	298	298
FOOTMETALSQPS	0.5	298	298	298	298	298	298	298
FOOTMETALRDBS	0.5	298	298	298	298	298	298	298
FOOTMETALRDPS	0.5	298	298	298	298	298	298	298
FOOTMETALANGBN	0.5	298	298	298	298	298	298	298
FOOTMETALANGPC	0.5	298	298	298	298	298	298	298
FOOTMETALANGTBN	0.5	298	298	298	298	298	298	298
FOOTMETALANGTPC	0.5	298	298	298	298	298	298	298

- BN = Brushed Nickel
- BS = Brushed Stainless
- PC = Polished Chrome
- PS = Polished Stainless

Modifications
Are Not
Available

Notes

Diamond Edge Modification Option Descriptions

Your Diamond Edge price guide contains charts with modification option codes for each applicable cabinetry product. Reference the listing below to identify the modification description.

End Panel Options	
Option	Description
AUTH	Authentic Flush End
CSFPE	Car Siding Flush Panel End
FL/FR	Finished Ends
FPE	Flush Panel End
INTGE	Integral End
IPE	Inset Panel Ends

Custom Modification Options	
Option	Description
BAND	Band All Edges
BND	Banding Location
BVR	Bottom Valance Rail
EX	Extended Stile
EX_OL	Extended Stile with Overlay
F.ALL	Finished All
F.FRT	Finished Edges
FLUT	Fluting
FTK	Flush Toekick
ID	Increased Depth
IH	Increased Height
IW	Increased Width
MLDG	Moulding Location
MLDG.ALL	Moulding All
NOMLDG	No Moulding
PRO	Profiled and Finished Edges
RD	Reduced Depth
RH	Reduced Height
ROSLUT	Rose Fluting
WTCLIP	Clipped Corner Wood Tops
WTR	Wide Top Rail

Fillers & Panels

Description	Model	Height	Height w/FTK Option	Price
FILLERS (SPECIFY STYLE and STAIN)				

WALL FILLERS

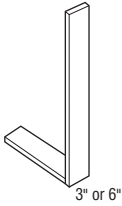

F330	30"	34.5"	106
F333	33"	37.5"	116
F336	36"	40.5"	129
F339	39"	43.5"	137
F342	42"	46.5"	139
F345	45"	49.5"	141
F348	48"	52.5"	145
F630	30"	34.5"	124
F633	33"	37.5"	149
F636	36"	40.5"	173
F639	39"	43.5"	181
F642	42"	46.5"	191
F645	45"	49.5"	198
F648	48"	52.5"	203

- Solid wood.
- Glazes and/or Techniques available: F, P, TW, XTW, HW, XHW.
- Increased or Reduced Heights available in 1/4" increments from 12" to 75".
- Height of filler excludes toekick height of 4 1/2", with the exception of Office fillers that have FTK standard.

Custom Modification Options

BVR	F.ALL	FLUT	FTK	IH ¹	RH	ROSLUT	WTR
✓		✓	✓	✓	✓	✓	✓

¹ Only available on 348 and 648 versions.

BASE FILLERS



FB330	30"	34.5"	107
FB630	30"	34.5"	138

- Solid wood.
- If Full Height is required, a Flush Toekick must be specified.
- Glazes and/or Techniques available: F, P, TW, XTW, HW, XHW.
- Increased or Reduced Heights available in 1/4" increments from 12" to 48".
- Height of filler excludes toekick height of 4 1/2", with the exception of Office fillers that have FTK standard.

Custom Modification Options

BVR	F.ALL	FLUT	FTK	IH	RH	ROSLUT	WTR
		✓	✓	✓	✓	✓	✓

Description	Model	Height	Height w/FTK Option	Price
OFFICE FILLERS				
FO329	29"	Included	106	
FO629	29"	Included	124	

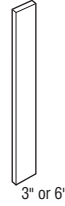

- Solid wood.
- Glazes and/or Techniques available: F, P, TW, XTW, HW, XHW.
- Height of filler excludes toekick height of 4 1/2", with the exception of Office fillers that have FTK standard.

Custom Modification Options

BVR	F.ALL	FLUT ¹	FTK	IH	RH	ROSLUT	WTR
		✓				✓	✓

¹ Not available with 6" fluting.

VANITY FILLERS



FV325.5	25.5"	30"	97
FV332	27.5"	32"	107
FV625.5	25.5"	30"	113
FV632	27.5"	32"	127

- Solid wood.
- If Full Height is required, a Flush Toekick must be specified.
- Glazes and/or Techniques available: F, P, TW, XTW, HW, XHW.
- Increased or Reduced Heights available in 1/4" increments from 12" to 48".
- Height of filler excludes toekick height of 4 1/2", with the exception of Office fillers that have FTK standard.



Custom Modification Options

BVR	F.ALL	FLUT ¹	FTK	IH	RH	ROSLUT ¹	WTR
		✓	✓	✓	✓	✓	✓

¹ Not available on 632 version.

Glazes and Techniques

- F = Flooded (see page E•4.)
- P = Penned (see page E•4.)
- TW = Timeworn (see page E•4.)
- XTW = Extra Timeworn (see page E•4.)
- HW = Hewn (see page E•4.)
- XHW = Extra Hewn (see page E•4.)

Description	Model	Height	Height w/FTK Option	Price
UTILITY FILLERS				
	TF384	79.5"	84"	181
	TF387	82.5"	87"	194
	TF390	85.5"	90"	205
	TF393	88.5"	93"	214
	TF396	91.5"	96"	229
	TF396FH	96"	96"	344
	TF684	79.5"	84"	268
	TF687	82.5"	87"	287
	TF690	85.5"	90"	300
	TF693	88.5"	93"	311
	TF696	91.5"	96"	325
	TF696FH	96"	96"	434
<ul style="list-style-type: none"> Reduced Heights available in 1/4" increments from 66" to 95 3/4". 				
	TF3102	97.5"	102"	234
	TF6102	97.5"	102"	329
	TF3108	103.5"	108"	239
	TF6108	103.5"	108"	333
	TF3120	115.5"	120"	250
	TF3120FH	115.5"	120"	250
TF6120	115.5"	120"	341	

• Reduced Heights available in 1/4" increments from 96 1/4" to 119 3/4".

Notes below apply to all products in section above:

- Solid wood.
- If Full Height is required, a Flush Toekick must be specified.
- Glazes and/or Techniques available: F, P, TW, XTW, HW, XHW.
- Height of filler excludes toekick height of 4 1/2", with the exception of Office fillers that have FTK standard.

Custom Modification Options

BVR	F.ALL	FLUT	FTK	IH	RH ¹	ROSLUT	WTR ²
✓	✓	✓	✓	✓	✓	✓	✓

¹ Not available on 102" high versions.

² Reference modification section for parameters.

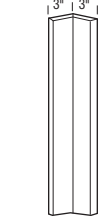
Description	Model	Height	Height w/FTK Option	Price																
WALL and BASE FILLERS																				
	135FW	30"	34.5"	175																
	135FW42	42"	46.5"	205																
	135FB	30"	34.5"	175																
<ul style="list-style-type: none"> • Solid wood. • If Full Height is required on a Base Filler, Flush Toekick must be specified. • Glazes and/or Techniques available: F, P, TW, XTW, HW, XHW. • Increased or Reduced Heights available in 1/4" increments from 12" to 48". • Height of filler excludes toekick height of 4 1/2", with the exception of Office fillers that have FTK standard. 																				
Custom Modification Options																				
<table border="1"> <thead> <tr> <th>BVR¹</th> <th>F.ALL</th> <th>FLUT²</th> <th>FTK</th> <th>IH³</th> <th>RH</th> <th>ROSLUT</th> <th>WTR</th> </tr> </thead> <tbody> <tr> <td>✓</td> <td>✓</td> <td>✓</td> <td>✓</td> <td>✓</td> <td>✓</td> <td>✓</td> <td>✓</td> </tr> </tbody> </table>					BVR ¹	F.ALL	FLUT ²	FTK	IH ³	RH	ROSLUT	WTR	✓	✓	✓	✓	✓	✓	✓	✓
BVR ¹	F.ALL	FLUT ²	FTK	IH ³	RH	ROSLUT	WTR													
✓	✓	✓	✓	✓	✓	✓	✓													
<p>¹ Not available on FB version. ² Not available with 6" fluting. ³ Not available on FW version.</p>																				

Description	Model	Height	Height w/FTK Option	Price
OFFICE and VANITY FILLERS				
	FBCV3	26.5"	30"	181
	FBCV332	27.5"	32"	202
	FBCO329	29"	Included	181
	CFB330	30"	34.5"	181

- Solid wood.
- If Full Height is required on a Vanity Filler, Flush Toekick must be specified.
- Glazes and/or Techniques available: F, P, TW, XTW, HW, XHW.
- Increased or Reduced Heights available in 1/4" increments from 12" to 48".
- Height of filler excludes toekick height of 4 1/2", with the exception of Office fillers that have FTK standard.

Custom Modification Options

BVR	F.ALL	FLUT ¹	FTK ²	IH ³	RH ³	ROSLUT	WTR ²
✓	✓	✓	✓	✓	✓	✓	✓

¹ Not available with 6" fluting.

² Not available on 329 version.

³ Only available on CFB330.

Glazes and Techniques

- F** = Flooded (see page E•4.)
- P** = Penned (see page E•4.)
- TW** = Timeworn (see page E•4.)
- XTW** = Extra Timeworn (see page E•4.)
- HW** = Hewn (see page E•4.)
- XHW** = Extra Hewn (see page E•4.)

Fillers & Panels

Description	Model	Height	Height w/FTK Option	Price
-------------	-------	--------	---------------------	-------

WALL FLUTED FILLERS

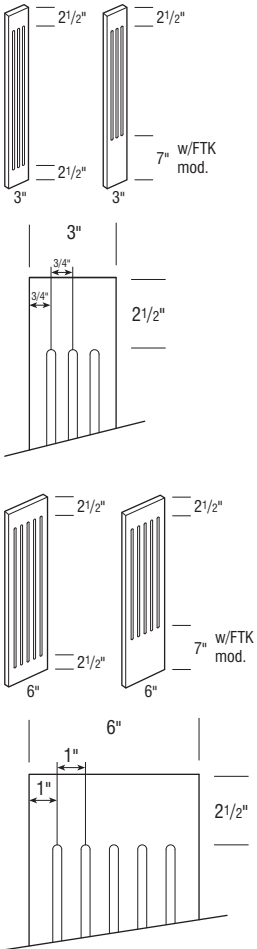

FF330	30"	34.5"	155
FF333	33"	37.5"	165
FF336	36"	40.5"	178
FF339	39"	43.5"	186
FF342	42"	46.5"	188
FF345	45"	49.5"	191
FF348	48"	52.5"	194
FF630	30"	34.5"	217
FF633	33"	37.5"	241
FF636	36"	40.5"	266
FF639	39"	43.5"	273
FF642	42"	46.5"	283
FF645	45"	49.5"	290
FF648	48"	52.5"	295

- Solid wood.
- 3/4" thick.
- Cleat included, but shipped loose.
- If full height is required with Flush Toe Kick modification, then flute changes to 7" from bottom of filler, but flute still remains 2 1/2" from top.
- Glazes and/or Techniques available: F, P, TW, XTW, HW, XHW.

Custom Modification Options							
BVR	F.ALL	FLUT	FTK	IH ¹	RH	ROSLUT	WTR
<input checked="" type="checkbox"/>	<input checked="" type="checkbox"/>	<input checked="" type="checkbox"/>	<input checked="" type="checkbox"/>	<input checked="" type="checkbox"/>	<input checked="" type="checkbox"/>	<input checked="" type="checkbox"/>	<input checked="" type="checkbox"/>

¹ Only available on 48" high.

Glazes and Techniques
F = Flooded (see page E•4.)
P = Penned (see page E•4.)
TW = Timeworn (see page E•4.)
XTW = Extra Timeworn (see page E•4.)
HW = Hewn (see page E•4.)
XHW = Extra Hewn (see page E•4.)

Description	Model	Height	Height w/FTK Option	Price
-------------	-------	--------	---------------------	-------

BASE FLUTED FILLERS

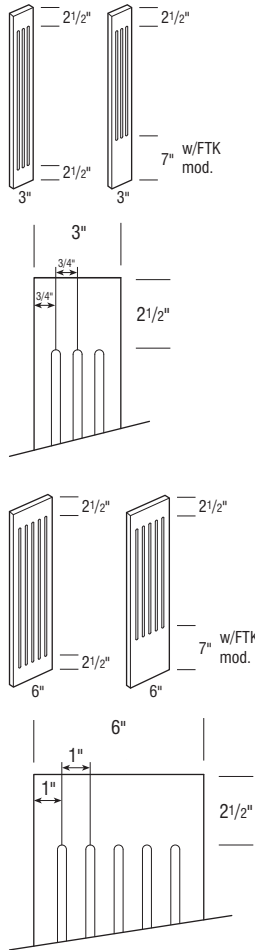

FFB330	30"	34.5"	156
FFB630	30"	34.5"	230

- Solid wood.
- 3/4" thick.
- If full height is required with Flush Toe Kick modification, then flute changes to 7" from bottom of filler, but flute still remains 2 1/2" from top.
- Glazes and/or Techniques available: F, P, TW, XTW, HW, XHW.

Custom Modification Options							
BVR	F.ALL	FLUT	FTK	IH	RH	ROSLUT	WTR
<input checked="" type="checkbox"/>	<input checked="" type="checkbox"/>	<input checked="" type="checkbox"/>	<input checked="" type="checkbox"/>	<input checked="" type="checkbox"/>	<input checked="" type="checkbox"/>	<input checked="" type="checkbox"/>	<input checked="" type="checkbox"/>

Description	Model	Height	Width	Price
VANITY FLUTED FILLERS	FFV325.5	25.5"	30"	146
	FFV332	27.5"	32"	156
	FFV625.5	25.5"	30"	205
	FFV632	27.5"	32"	219

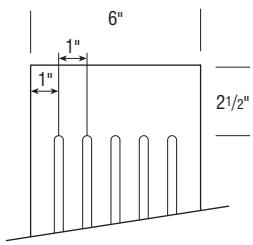
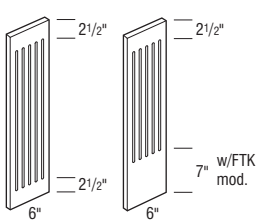
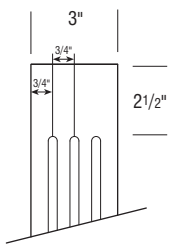
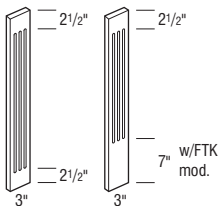

- Solid wood.
- 3/4" thick.
- If full height is required with Flush Toe Kick modification, then flute changes to 7" from bottom of filler, but flute still remains 2 1/2" from top.
- Glazes and/or Techniques available: F, P, TW, XTW, HW, XHW.

Custom Modification Options

BVR	F.ALL	FLUT	FTK	IH	RH	ROSFLUT	WTR
		✓		✓	✓		✓

Description	Model	Height	Width	Price
OFFICE FLUTED FILLERS	FFO329	29"	Included	155
	FFO629	29"	Included	217

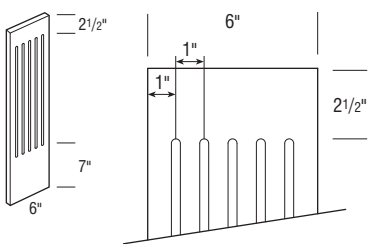
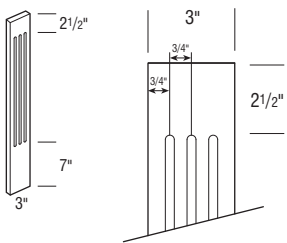

- Solid wood.
- 3/4" thick.
- Glazes and/or Techniques available: F, P, TW, XTW, HW, XHW.

Custom Modification Options

BVR	F.ALL	FLUT	FTK	IH	RH	ROSFLUT	WTR
		✓					✓

Description	Model	Height	Width	Price
TALL FLUTED FILLERS	FTF384	79.5"	84"	230
	FTF387	82.5"	87"	244
	FTF390	85.5"	90"	255
	FTF393	88.5"	93"	263
	FTF396	91.5"	96"	278
	FTF396FH	96"	96"	278
	FTF3102	97.5"	102"	283
	FTF3108	103.5"	108"	288
	FTF3120	115.5"	120"	299
	FTF684	79.5"	84"	360
	FTF687	82.5"	87"	379
	FTF690	85.5"	90"	392
	FTF693	88.5"	93"	403
	FTF696	91.5"	96"	417
FTF696FH	96"	96"	417	
FTF6102	97.5"	102"	422	
FTF6108	103.5"	108"	426	
FTF6120	115.5"	120"	433	

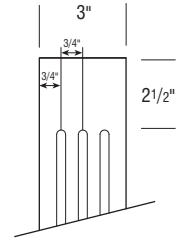
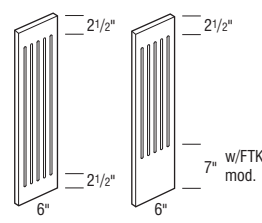
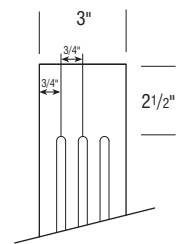
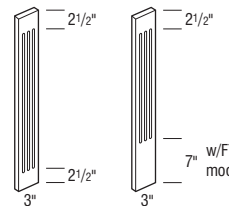

- Solid wood.
- 3/4" thick.
- If full height is required with Flush Toe Kick modification, then flute changes to 7" from bottom of filler, but flute still remains 2 1/2" from top.
- Glazes and/or Techniques available: F, P, TW, XTW, HW, XHW.

Custom Modification Options

BVR	F.ALL	FLUT ¹	FTK ²	IH	RH ²	ROSFLUT ¹	WTR
		✓	✓	✓	✓	✓	✓

¹ Only available on TF687.
² Not available on FH versions.

Glazes and Techniques
F = Flooded (see page E•4.)
P = Penned (see page E•4.)
TW = Timeworn (see page E•4.)
XTW = Extra Timeworn (see page E•4.)
HW = Hewn (see page E•4.)
XHW = Extra Hewn (see page E•4.)

Wood Tops

Description	Model	Price
WOOD TOPS		

WOOD TOPS

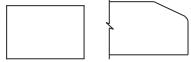

No Moulding Beveled edge

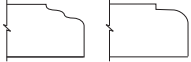

Ogee edge Round Over edge



Square edge

WOODTOPNOMLD (No moulding)	90
WOODTOPBE (Beveled edge)	90
WOODTOPOG (Ogee edge)	90
WOODTOPRO (Round over edge)	90
WOODTOPSE (Square edge)	90

- Price is per square foot.
- 1 1/2" thick.

Custom Modification Options

MLDG	MLDG.ALL	NOMLDG ¹	WTCLIP	WTR
✓	✓	✓	✓	✓

¹ Only available on WOODTOPNOMLD.

WOOD TOP, ONE SIDED

1TWT7221	841
1TWT7224	956

- 1/2" thick.
- Nomenclature refers to width and depth of cabinetry being used. See actual dimension of wood top in chart.

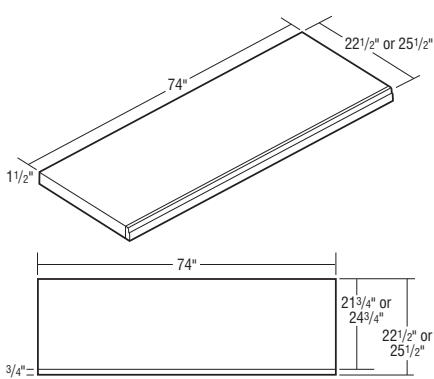

22 1/2" Deep	Overall Width	Overall Depth
1TWT7221	74"	22 1/2"

25 1/2" Deep	Overall Width	Overall Depth
1TWT7224	74"	25 1/2"

Custom Modification Options

MLDG	MLDG.ALL	NOMLDG ¹	WTCLIP	WTR
✓	✓	✓	✓	✓

¹ Only available on NOMLDG version.

Description	Model	Price
WOOD TOP, THREE SIDED		

3TWT1821	253
3TWT2421	330
3TWT3021	405
3TWT3621	482
3TWT4821	634
3TWT5421	709
3TWT6021	786
3TWT6621	863
3TWT7221	937

3TWT1824	288
3TWT2424	373
3TWT3024	459
3TWT3624	546
3TWT4824	718
3TWT5424	806
3TWT6024	889
3TWT6624	976
3TWT7224	1062

- 1/2" thick.
- Nomenclature refers to width and depth of cabinetry being used. See actual dimension of wood top in chart.

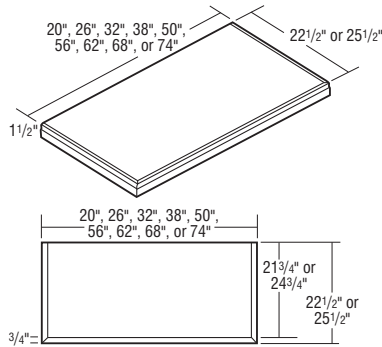

22 1/2" Deep	Overall Width	Overall Depth
3TWT1821	20"	22 1/2"
3TWT2421	26"	22 1/2"
3TWT3021	32"	22 1/2"
3TWT3621	38"	22 1/2"
3TWT4821	50"	22 1/2"
3TWT5421	56"	22 1/2"
3TWT6021	62"	22 1/2"
3TWT6621	68"	22 1/2"
3TWT7221	74"	22 1/2"

25 1/2" Deep	Overall Width	Overall Depth
3TWT1824	20"	25 1/2"
3TWT2424	26"	25 1/2"
3TWT3024	32"	25 1/2"
3TWT3624	38"	25 1/2"
3TWT4824	50"	25 1/2"
3TWT5424	56"	25 1/2"
3TWT6024	62"	25 1/2"
3TWT6624	68"	25 1/2"
3TWT7224	74"	25 1/2"

Custom Modification Options

MLDG	MLDG.ALL	NOMLDG ¹	WTCLIP	WTR
✓	✓	✓	✓	✓

¹ Only available on NOMLDG version.

Glazes and Techniques

- F** = Flooded (see page E•4.)
- P** = Penned (see page E•4.)
- TW** = Timeworn (see page E•4.)
- XTW** = Extra Timeworn (see page E•4.)
- HW** = Hewn (see page E•4.)
- XHW** = Extra Hewn (see page E•4.)

Description	Model	Price
WOOD TOP, FOUR SIDED	4TWT4827	818
	4TWT5427	917
	4TWT6027	1015
	4TWT6627	1114
	4TWT7227	1212
	4TWT4833	999
	4TWT5433	1119
	4TWT6033	1242
	4TWT6633	1361
	4TWT7233	1480

- 1/2" thick.
- Nomenclature refers to width and depth of cabinetry being used. See actual dimension of wood top in chart.

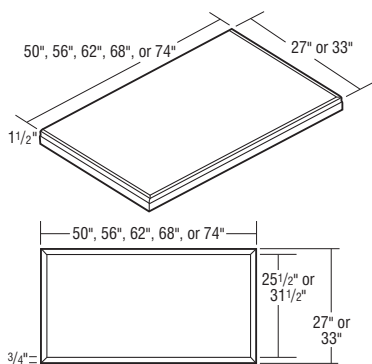

27" Deep	Overall Width	Overall Depth
4TWT4827	50"	27"
4TWT5427	56"	27"
4TWT6027	62"	27"
4TWT6627	68"	27"
4TWT7227	74"	27"

33" Deep	Overall Width	Overall Depth
4TWT4833	50"	33"
4TWT5433	56"	33"
4TWT6033	62"	33"
4TWT6633	68"	33"
4TWT7233	74"	33"

Custom Modification Options

MLDG	MLDG.ALL	NOMLDG ¹	WTCLIP	WTR
<input checked="" type="checkbox"/>	<input checked="" type="checkbox"/>	<input checked="" type="checkbox"/>	<input checked="" type="checkbox"/>	<input checked="" type="checkbox"/>

¹ Only available on NOMLDG version.

Description	Model	Price
WOOD TOPS for ANGLED and BASE END CABINETS — BEVELED EDGE	WTOPBAC2412BE	348
	WTOPBAC2415BE	348
	WTOPBAC2418BE	348
	WTOPBAC2421BE	348
	WTOPBAC24BE	348

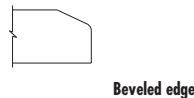
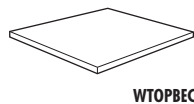

WTOPBEC2412BE	348
WTOPBEC2415BE	348
WTOPBEC2418BE	348
WTOPBEC2421BE	348
WTOPBEC24BE	348

- Available on all BAC, BAC_FH, BEC, and BEC_FH cabinets.
- Not available on BTC12.
- Glazes and/or Techniques available: F, HW, XHW

Custom Modification Options

MLDG	MLDG.ALL	NOMLDG	WTCLIP	WTR
<input type="checkbox"/>	<input type="checkbox"/>	<input type="checkbox"/>	<input checked="" type="checkbox"/>	<input type="checkbox"/>

Description	Model	Price
WOOD TOPS for ANGLED and BASE END CABINETS — OGEE EDGE	WTOPBAC2412OG	348
	WTOPBAC2415OG	348
	WTOPBAC2418OG	348
	WTOPBAC2421OG	348
	WTOPBAC24OG	348



WTOPBEC2412OG	348
WTOPBEC2415OG	348
WTOPBEC2418OG	348
WTOPBEC2421OG	348
WTOPBEC24OG	348

- Available on all BAC, BAC_FH, BEC, and BEC_FH cabinets.
- Not available on BTC12.
- Glazes and/or Techniques available: F, HW, XHW.

Custom Modification Options

MLDG	MLDG.ALL	NOMLDG	WTCLIP	WTR
<input type="checkbox"/>	<input type="checkbox"/>	<input type="checkbox"/>	<input checked="" type="checkbox"/>	<input type="checkbox"/>

Glazes and Techniques

- F** = Flooded (see page E•4.)
- P** = Penned (see page E•4.)
- TW** = Timeworn (see page E•4.)
- XTW** = Extra Timeworn (see page E•4.)
- HW** = Hewn (see page E•4.)
- XHW** = Extra Hewn (see page E•4.)

Fillers & Panels

Description	Model	Price
WOOD TOPS for ANGLED and BASE END CABINETS — ROUND OVER	WTOPBAC2412RO	348
	WTOPBAC2415RO	348
	WTOPBAC2418RO	348
	WTOPBAC2421RO	348
	WTOPBAC24RO	348



WTOPBAC

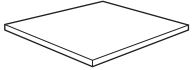

WTOPBEC



Beveled edge

WTOPBEC2412RO	348
WTOPBEC2415RO	348
WTOPBEC2418RO	348
WTOPBEC2421RO	348
WTOPBEC24RO	348

- Available on all BAC, BAC_FH, BEC, and BEC_FH cabinets.
- Not available on BTC12.
- Glazes and/or Techniques available: F, HW, XHW.

Custom Modification Options

MLDG	MLDG.ALL	NOMLDG	WTCLIP	WTR
<input type="checkbox"/>	<input type="checkbox"/>	<input type="checkbox"/>	<input checked="" type="checkbox"/>	<input type="checkbox"/>

Description	Model	Price
WOOD TOPS for ANGLED and BASE END CABINETS — SQUARE EDGE	WTOPBAC2412SE	348
	WTOPBAC2415SE	348
	WTOPBAC2418SE	348
	WTOPBAC2421SE	348
	WTOPBAC24SE	348



WTOPBAC

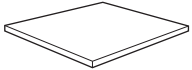

WTOPBEC



Beveled edge

WTOPBEC2412SE	348
WTOPBEC2415SE	348
WTOPBEC2418SE	348
WTOPBEC2421SE	348
WTOPBEC24SE	348

- Available on all BAC, BAC_FH, BEC, and BEC_FH cabinets.
- Not available on BTC12.
- Glazes and/or Techniques available: F, HW, XHW

Custom Modification Options

MLDG	MLDG.ALL	NOMLDG	WTCLIP	WTR
<input type="checkbox"/>	<input type="checkbox"/>	<input type="checkbox"/>	<input checked="" type="checkbox"/>	<input type="checkbox"/>

Description	Model	Height	Height w/FTK Option	Price
OVERLAY FILLERS for FULL OVERLAY STYLES (SPECIFY STYLE, STAIN and PROFILE)				

WALL OVERLAY FILLERS

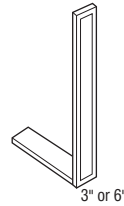

OL330	30"	34.5"	139
OL333	33"	37.5"	154
OL336	36"	49.5"	171
OL339	39"	43.5"	183
OL342	42"	46.5"	202
OL345	45"	49.5"	221
OL348	48"	52.5"	242
OL354	54"	58.5"	261
OL630	30"	34.5"	280
OL633	33"	37.5"	309
OL636	36"	40.5"	340
OL639	39"	43.5"	369
OL642	42"	46.5"	400
OL645	45"	49.5"	439
OL648	48"	52.5"	476
OL654	54"	58.5"	512

- 3" Wide Overlays with #18 profile will have overlay sent with #14 profile.
- Overlays profiled on all four sides.
- Glazes and/or Techniques available: F, P, TW, XTW, HW, XHW.
- Increased or Reduced Heights available in 1/4" increments from 12" to 75".
- Height of filler excludes toe kick height of 4 1/2", with the exception of Office fillers that have FTK standard.
- Not available with Inset or Beaded Inset Styles.

Overlay width dimensions:

- 2 9/16" overlay for 3" fillers
- 5 9/16" overlay for 6" fillers

Custom Modification Options

BVR	FTK	IH ¹	OONLY	RH	WTR
<input checked="" type="checkbox"/>	<input checked="" type="checkbox"/>	<input checked="" type="checkbox"/>	<input checked="" type="checkbox"/>	<input checked="" type="checkbox"/>	<input checked="" type="checkbox"/>

¹ Only available on 354 and 654 versions.

Glazes and Techniques

- F = Flooded (see page E04.)
- P = Penned (see page E04.)
- TW = Timeworn (see page E04.)
- XTW = Extra Timeworn (see page E04.)
- HW = Hewn (see page E04.)
- XHW = Extra Hewn (see page E04.)

Description	Model	Height	Height w/FTK Option	Price
BASE OVERLAY FILLERS	OFB330	30"	34.5"	139
	OFB630	30"	34.5"	268



- 3" Wide Overlays with #18 profile will have overlay sent with #14 profile.
- Overlays profiled on all four sides.
- If Full Height is required, a Flush Toekick must be specified.
- Glazes and/or Techniques available:
F, P, TW, XTW, HW, XHW.
- Increased or Reduced Heights available in 1/4" increments from 12" to 48".
- Height of filler excludes toekick height of 4 1/2", with the exception of Office fillers that have FTK standard.
- Not available with Inset or Beaded Inset Styles.

Overlay width dimensions:
2 9/16" overlay for 3" fillers
5 9/16" overlay for 6" fillers

Custom Modification Options

BVR	FTK	IH	OONLY	RH	WTR
✓	✓	✓	✓	✓	✓

OFFICE and VANITY OVERLAY FILLERS



OFO329	29"	Included	139
OFO629	29"	Included	280
OFV325.5	25.5"	30"	138
OFV332	27.5"	32"	150
OFV625.5	25.5"	30"	261
OFV632	27.5"	32"	290

- 3" Wide Overlays with #18 profile will have overlay sent with #14 profile.
- Overlays profiled on all four sides.
- If Full Height is required on a Vanity Filler, Flush Toekick must be specified.
- Glazes and/or Techniques available:
F, P, TW, XTW, HW, XHW.
- Increased or Reduced Heights available in 1/4" increments from 12" to 48".
- Height of filler excludes toekick height of 4 1/2", with the exception of Office fillers that have FTK standard.
- Not available with Inset or Beaded Inset Styles.

Overlay width dimensions:
2 9/16" overlay for 3" fillers
5 9/16" overlay for 6" fillers

Custom Modification Options

BVR	FTK ¹	IH ¹	OONLY	RH ¹	WTR
✓	✓	✓	✓	✓	✓

¹ Not available on 329 and 629 versions.

Description	Model	Height	Height w/FTK Option	Price
UTILITY OVERLAY FILLERS	OL384	79.5"	84"	310
	OL387	82.5"	87"	372
	OL390	85.5"	90"	433
	OL393	88.5"	93"	509
	OL396	91.5"	96"	587
	OL684	79.5"	84"	587
	OL687	82.5"	87"	624
	OL690	85.5"	90"	658
	OL693	88.5"	93"	696
	OL696	91.5"	96"	736
	OL3102	97.5"	102"	635
	OL6102	97.5"	102"	771
	OL3108	103.5"	108"	682
	OL6108	103.5"	108"	806
OL3120	115.5"	120"	789	
OL6120	115.5"	120"	865	

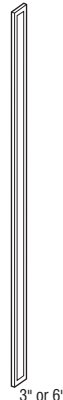

- Reduced Heights available in 1/4" increments from 66" to 95 3/4".

OL3102	97.5"	102"	635
OL6102	97.5"	102"	771
OL3108	103.5"	108"	682
OL6108	103.5"	108"	806
OL3120	115.5"	120"	789
OL6120	115.5"	120"	865

- Reduced Heights available in 1/4" increments from 96 1/4" to 119 3/4".
- All fillers over 96" high will get three equal overlays.

Notes below apply to all products in section above:

- 3" Wide Overlays with #18 profile will have overlay sent with #14 profile.
- Overlays profiled on all four sides.
- If Full Height is required, a Flush Toekick must be specified.
- Glazes and/or Techniques available:
F, P, TW, XTW, HW, XHW.
- Height of filler excludes toekick height of 4 1/2", with the exception of Office fillers that have FTK standard.
- Not available with Inset or Beaded Inset Styles.

Overlay width dimensions:
2 9/16" overlay for 3" fillers
5 9/16" overlay for 6" fillers

Custom Modification Options

BVR	FTK	IH	OONLY	RH	WTR
✓	✓	✓	✓	✓	✓

Glazes and Techniques

- F** = Flooded (see page E•4.)
- P** = Penned (see page E•4.)
- TW** = Timeworn (see page E•4.)
- XTW** = Extra Timeworn (see page E•4.)
- HW** = Hewn (see page E•4.)
- XHW** = Extra Hewn (see page E•4.)

Fillers & Panels

Description	Model	Height	Height w/FTK Option	Price
WALL, BASE, OFFICE, and VANITY 135° OVERLAY FILLERS	1350FW	30"	34.5"	289
	1350FW33	33"	37.5"	311
	1350FW36	36"	40.5"	340
	1350FW39	39"	43.5"	357
	1350FW42	42"	46.5"	376
	1350FW45	45"	49.5"	397
	1350FW48	48"	52.5"	416
	1350FW54	54"	58.5"	433
	1350FV	25.5"	30"	257
	1350FV32	27.5"	32"	289
1350F029	29"	Included	257	
1350FB	30"	34.5"	312	

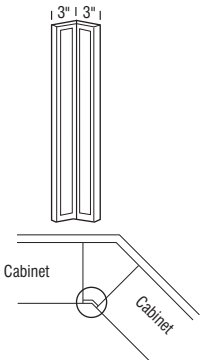

Installation of 1350FW, 1350F029 and 1350FB (overhead view)

- 3" Wide Overlays with #18 profile will have overlay sent with #14 profile.
- Overlays profiled on all four sides.
- If Full Height is required on a Base or Vanity Filler, Flush Toekick must be specified.
- Glazes and/or Techniques available: F, P, TW, XTW, HW, XHW.
- Increased or Reduced Heights available in 1/4" increments from 12" to 48".
- Height of filler excludes toekick height of 4 1/2", with the exception of Office fillers that have FTK standard.
- Not available with Inset or Beaded Inset Styles.

Overlay width dimensions:
 2 9/16" overlay for 3" fillers
 5 9/16" overlay for 6" fillers

Custom Modification Options

BVR ¹	FTK ²	IH ³	OONLY	RH	WTR
<input checked="" type="checkbox"/>	<input checked="" type="checkbox"/>	<input checked="" type="checkbox"/>	<input checked="" type="checkbox"/>	<input checked="" type="checkbox"/>	<input checked="" type="checkbox"/>

¹ Only available on OFW versions.

² Not available on 1350F029.

³ Not available on OFW versions except OFW54.

OVERLAY FILLERS

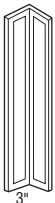

Description	Model	Height	Height w/FTK Option	Price
OVERLAY FILLERS	OFBC330	30"	34.5"	280

- 3" Wide Overlays with #18 profile will have overlay sent with #14 profile.
- Overlays profiled on all four sides.
- If Full Height is required, a Flush Toekick must be specified.
- Glazes and/or Techniques available: F, P, TW, XTW, HW, XHW.
- Increased or Reduced Heights available in 1/4" increments from 12" to 48".
- Height of filler excludes toekick height of 4 1/2", with the exception of Office fillers that have FTK standard.
- Not available with Inset or Beaded Inset Styles.

Overlay width dimensions:
 2 9/16" overlay for 3" fillers

Custom Modification Options

BVR	FTK	IH	OONLY	RH	WTR
<input checked="" type="checkbox"/>	<input checked="" type="checkbox"/>	<input checked="" type="checkbox"/>	<input checked="" type="checkbox"/>	<input checked="" type="checkbox"/>	<input checked="" type="checkbox"/>

Glazes and Techniques

- F = Flooded (see page E•4.)
- P = Penned (see page E•4.)
- TW = Timeworn (see page E•4.)
- XTW = Extra Timeworn (see page E•4.)
- HW = Hewn (see page E•4.)
- XHW = Extra Hewn (see page E•4.)

BOX COLUMN FILLERS

Description	Model	Price
WALL – PLAIN, 3" WIDE, 15" DEEP	W330BCFP	774
	W333BCFP	812
	W336BCFP	849
	W339BCFP	914
	W342BCFP	978
	W345BCFP	1028
	W348BCFP	1083
	W354BCFP	1161
	W360BCFP	1236

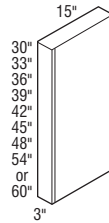

- Flush Panel Ends standard.
- Reversible, may be used on either left or right end.
- Front and both sides finished, back is unfinished.
- Enclosed top and bottom.
- Unit is field trimmable to any required depth.
- Increased Depths available in 1/4" increments from 15 1/4" to 30".
- Reduced Depths available in 1/4" increments from 9" to 14 3/4".
- Increased Heights available in 1/4" increments from 60 1/4" to 70".
- Reduced Heights available in 1/4" increments from 12" to 59 3/4".
- Increased Widths available in 1/4" increments. See page G•46 for details.
- Not intended for use horizontally as shelving. Use Floating Shelves on page R•22.
- Glazes and/or Techniques available: F, P, TW, XTW, HW, XHW.

End Panel Options

CSFPE
<input checked="" type="checkbox"/>

Custom Modification Options

FLUT	ID	IH ¹	IW	RD	RH	ROSFLUT
<input checked="" type="checkbox"/>	<input checked="" type="checkbox"/>	<input checked="" type="checkbox"/>	<input checked="" type="checkbox"/>	<input checked="" type="checkbox"/>	<input checked="" type="checkbox"/>	<input checked="" type="checkbox"/>

¹ Only available on 360 version.

Description	Model	Price
WALL – PLAIN, 6" WIDE, 15" DEEP	W630BCFP	849
	W633BCFP	893
	W636BCFP	935
	W639BCFP	1009
	W642BCFP	1078
	W645BCFP	1139
	W648BCFP	1195
	W654BCFP	1226
W660BCFP	1391	

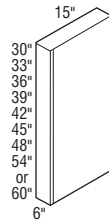

- Flush Panel Ends standard.
- Reversible, may be used on either left or right end.
- Front and both sides finished, back is unfinished.
- Enclosed top and bottom.
- Unit is field trimmable to any required depth.
- Increased Depths available in 1/4" increments from 15 1/4" to 30".
- Reduced Depths available in 1/4" increments from 9" to 14 3/4".
- Increased Heights available in 1/4" increments from 60 1/4" to 70".
- Reduced Heights available in 1/4" increments from 12" to 59 3/4".
- Increased Widths available in 1/4" increments. See page G•46 for details.
- Not intended for use horizontally as shelving. Use Floating Shelves on page R•22.
- Glazes and/or Techniques available: F, P, TW, XTW, HW, XHW.

End Panel Options

CSFPE
<input checked="" type="checkbox"/>

Custom Modification Options

FLUT	ID	IH ¹	IW	RD	RH	ROSFLUT
<input checked="" type="checkbox"/>	<input checked="" type="checkbox"/>	<input checked="" type="checkbox"/>	<input checked="" type="checkbox"/>	<input checked="" type="checkbox"/>	<input checked="" type="checkbox"/>	<input checked="" type="checkbox"/>

¹ Only available on 660 version.

Description	Model	Price
BASE – PLAIN, 27" DEEP	B334.527BCFP	1083

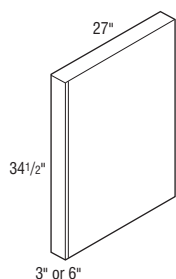

B634.527BCFP	1166
---------------------	------

- Flush Toekick and Flush Panel Ends standard.
- Reversible, may be used on either left or right end.
- Front and both sides finished, back is unfinished.
- Enclosed top and bottom.
- Unit is field trimmable to any required depth.
- Increased Depths available in 1/4" increments from 27 1/4" to 30".
- Reduced Depths available in 1/4" increments from 9" to 26 3/4".
- Increased Heights available in 1/4" increments from 34 3/4" to 46 1/2".
- Reduced Heights available in 1/4" increments from 12" to 34 1/4".
- Increased Widths available in 1/4" increments. See page G•46 for details.
- Not intended for use horizontally as shelving. Use Floating Shelves on page R•22.
- Glazes and/or Techniques available: F, P, TW, XTW, HW, XHW.

End Panel Options

CSFPE
✓

Custom Modification Options

FLUT ¹	ID	IH	IW	RD	RH	ROSFLUT
✓	✓	✓	✓	✓	✓	✓

¹ Only available with 3" fluting.

OFFICE – PLAIN, 27" DEEP	O32927BCFP	774
---------------------------------	-------------------	-----

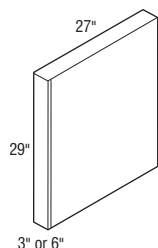

O62927BCFP	849
-------------------	-----

- Flush Toekick and Flush Panel Ends standard.
- Reversible, may be used on either left or right end.
- Front and both sides finished, back is unfinished.
- Enclosed top and bottom.
- Unit is field trimmable to any required depth.
- Increased Depths available in 1/4" increments from 27 1/4" to 30".
- Reduced Depths available in 1/4" increments from 9" to 26 3/4".
- Increased Heights available in 1/4" increments from 29 1/4" to 46 1/2".
- Reduced Heights available in 1/4" increments from 12" to 28 3/4".
- Not intended for use horizontally as shelving. Use Floating Shelves on page R•22.
- Glazes and/or Techniques available: F, P, TW, XTW, HW, XHW.

End Panel Options

CSFPE
✓

Custom Modification Options

FLUT	ID	IH	IW	RD	RH	ROSFLUT
✓	✓	✓	✓	✓	✓	✓

Description	Model	Price
VANITY – PLAIN, 24" DEEP	V33024BCFP	1057

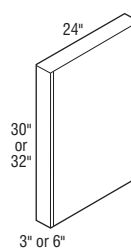

V33224BCFP	1164
V63024BCFP	1165
V63224BCFP	1283

- Flush Toekick and Flush Panel Ends standard.
- Reversible, may be used on either left or right end.
- Front and both sides finished, back is unfinished.
- Enclosed top and bottom.
- Unit is field trimmable to any required depth.
- Increased Depths available in 1/4" increments from 24 1/4" to 30".
- Reduced Depths available in 1/4" increments from 9" to 23 3/4".
- Increased Heights available in 1/4" increments from 32 1/4" to 46 1/2".
- Reduced Heights available in 1/4" increments from 12" to 29 3/4".
- Increased Widths available in 1/4" increments. See page G•46 for details.
- Not intended for use horizontally as shelving. Use Floating Shelves on page R•22.
- Glazes and/or Techniques available: F, P, TW, XTW, HW, XHW.

End Panel Options

CSFPE
✓

Custom Modification Options

FLUT	ID	IH	IW	RD	RH	ROSFLUT
✓	✓	✓	✓	✓	✓	✓

Glazes and Techniques

- F = Flooded (see page E•4.)
- P = Penned (see page E•4.)
- TW = Timeworn (see page E•4.)
- XTW = Extra Timeworn (see page E•4.)
- HW = Hewn (see page E•4.)
- XHW = Extra Hewn (see page E•4.)

Fillers & Panels

Description	Model	Price
TALL – PLAIN, 15" DEEP	T38415BCFP	1495
	T38715BCFP	1548
	T39015BCFP	1600
	T39315BCFP	1653
	T39615BCFP	1704
	NEW T310215BCFP	2240
	NEW T310815BCFP	2350
	NEW T312015BCFP	2571
	T68415BCFP	1723
	T68715BCFP	1780
	T69015BCFP	1838
	T69315BCFP	1897
	T69615BCFP	1958
	NEW T610215BCFP	2576
NEW T610815BCFP	2705	
NEW T612015BCFP	2962	

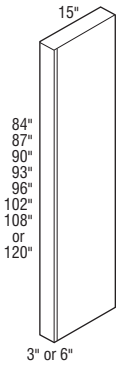

- Flush Toe Kick and Flush Panel Ends standard.
- Reversible, may be used on either left or right end.
- Front and both sides finished.
- Enclosed top and bottom.
- Unit is field trimmable to any required depth.
- Increased Depths available in 1/4" increments from 15 1/4" to 30".
- Reduced Depths available in 1/4" increments from 9" to 14 3/4".
- Reduced Heights available in 1/4" increments from 60" to 119 3/4".
- Not intended for use horizontally as shelving. Use Floating Shelves on page R●22.
- Glazes and/or Techniques available: F, P, TW, XTW, HW, XHW.

End Panel Options

CSFPE

Custom Modification Options

FLUT	ID	IH	IW	RD	RH	ROSLUT
✓	✓			✓	✓	✓

Description	Model	Price
TALL – PLAIN, 27" DEEP	T38427BCFP	2615
	T38727BCFP	2709
	T39027BCFP	2796
	T39327BCFP	2890
	T39627BCFP	2979
	NEW T310227BCFP	3919
	NEW T310827BCFP	4115
	NEW T312027BCFP	4506
	T68427BCFP	3010
	T68727BCFP	3117
	T69027BCFP	3222
	T69327BCFP	3325
	T69627BCFP	3430
	NEW T610227BCFP	4508
NEW T610827BCFP	4728	
NEW T612027BCFP	5169	

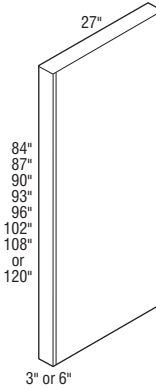

- Flush Toe Kick and Flush Panel Ends standard.
- Reversible, may be used on either left or right end.
- Front and both sides finished.
- Enclosed top and bottom.
- Unit is field trimmable to any required depth.
- Increased Depths available in 1/4" increments from 27 1/4" to 30".
- Reduced Depths available in 1/4" increments from 9" to 26 3/4".
- Reduced Heights available in 1/4" increments from 60" to 119 3/4".
- Not intended for use horizontally as shelving. Use Floating Shelves on page R●22.
- Glazes and/or Techniques available: F, P, TW, XTW, HW, XHW.

End Panel Options

CSFPE ¹
✓

Custom Modification Options

FLUT	ID	IH	IW	RD	RH	ROSLUT
✓	✓			✓	✓	✓

¹ Reference modification section for parameters.

Glazes and Techniques

- F = Flooded (see page E●4.)
- P = Penned (see page E●4.)
- TW = Timeworn (see page E●4.)
- XTW = Extra Timeworn (see page E●4.)
- HW = Hewn (see page E●4.)
- XHW = Extra Hewn (see page E●4.)

Description	Model	Height	Height w/FTK Option	Price
ANGLED FILLERS (SPECIFY STYLE and STAIN)				

ANGLED FILLERS, 3"

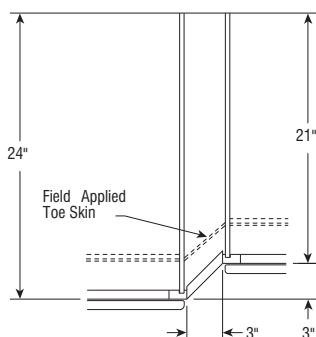
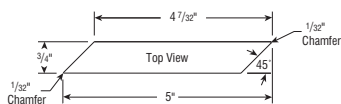

Top View of Installation
Angled Filler Change in Depth
Right Shown

45FW30	30"	34.5"	203
45FW33	33"	37.5"	280
45FW36	36"	40.5"	358
45FW39	39"	43.5"	360
45FW42	42"	46.5"	363
45FW45	45"	49.5"	363
45FW48	48"	52.5"	363

- Glazes and/or Techniques available:
F, P, TW, XTW, HW, XHW.
- Reduced Heights available in 1/4" increments from 12" to 75".

45FB	30"	34.5"	205
45FO29	29"	Included	203
45FV	25.5"	30"	203

- Reduced Heights available in 1/4" increments from 12" to 48".

45FU84	79.5"	84"	482
45FU87	82.5"	87"	497
45FU90	85.5"	90"	513
45FU93	88.5"	93"	531
45FU96	91.5"	96"	545

- Toekick and return not available.
- Reduced Heights available in 1/4" increments from 66" to 95 3/4".
- Height of filler excludes toekick height of 4 1/2", with the exception of Office fillers that have FTK standard.

Custom Modification Options

BVR ¹	FLUT ²	FTK ³	IH ⁴	RH ⁵	WTR ⁶
<input checked="" type="checkbox"/>	<input checked="" type="checkbox"/>	<input checked="" type="checkbox"/>	<input checked="" type="checkbox"/>	<input checked="" type="checkbox"/>	<input checked="" type="checkbox"/>

- ¹ Only available on FW versions.
² Not available with fluting both or 6" fluting.
³ Not available on 45FO29.
⁴ Not available on FW versions except FW48 and not available on FU versions.
⁵ Not available on FU96 version.
⁶ Not available on 45FB or 45FO29.

Description	Model	Price
PANELS (SPECIFY STYLE and STAIN)		

WALL END PANEL, 12" or 13" DEEP, 30" HIGH

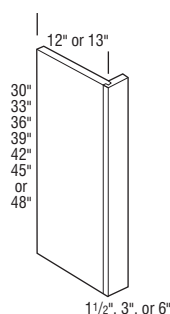

WEPF1.5WD	182
WEPF1.533WD	204
WEPF1.536WD	230
WEPF1.539WD	251
WEPF1.542WD	278
WEPF1.545WD	301
WEPF1.548WD	320

- Fluting and Rose Fluting not available.

WEPF3WD	203
WEPF333WD	223
WEPF336WD	248
WEPF339WD	274
WEPF342WD	301
WEPF345WD	326
WEPF348WD	351

WEPF6WD	251
WEPF633WD	279
WEPF636WD	310
WEPF639WD	346
WEPF642WD	376
WEPF645WD	410
WEPF648WD	442

Notes below apply to all products in section above:

- 1/2" wood veneer with face frame attached.
- Inset and Beaded Inset styles are a standard 13" deep.
- Full Overlay Styles:
 - Increased Depths available in 1/4" increments from 12 1/4" to 36".
 - Reduced Depths available in 1/4" increments from 6" to 11 3/4".
- Inset and Beaded Inset Styles:
 - Increased Depths available in 1/4" increments from 13 1/4" to 24".
 - Reduced Depths available in 1/4" increments from 6" to 12 3/4".
- Reduced Heights available in 1/4" increments from 12" to 47 3/4".
- Increased Widths available in 1/4" increments. See page G-46 for details.
- Glazes and/or Techniques available:
F, P, TW, XTW, HW, XHW.

End Panel Options

AUTH ¹	CSFPE	EL/FR	FPE	INTGE	IPE
<input checked="" type="checkbox"/>	<input checked="" type="checkbox"/>	<input checked="" type="checkbox"/>	<input checked="" type="checkbox"/>	<input checked="" type="checkbox"/>	<input checked="" type="checkbox"/>

Custom Modification Options

BVR ²	EX ³	FLUT ⁴	ID	IH ⁵	IW ³	RD	RH	ROSLUT ⁴	WTR ²
<input checked="" type="checkbox"/>	<input checked="" type="checkbox"/>	<input checked="" type="checkbox"/>	<input checked="" type="checkbox"/>	<input checked="" type="checkbox"/>	<input checked="" type="checkbox"/>	<input checked="" type="checkbox"/>	<input checked="" type="checkbox"/>	<input checked="" type="checkbox"/>	<input checked="" type="checkbox"/>

- ¹ Not available with authentic flush ends both.
² Not available on 1.5" wide.
³ Not available on 6" wide.
⁴ Not available on 1.5" wide or with fluting both.
⁵ Only available on 48 versions.

Glazes and Techniques

F = Flooded (see page E-4.)
P = Penned (see page E-4.)
TW = Timeworn (see page E-4.)
XTW = Extra Timeworn (see page E-4.)
HW = Hewn (see page E-4.)
XHW = Extra Hewn (see page E-4.)

Fillers & Panels

Description

BASE END PANEL, 24" DEEP, 34 1/2" HIGH

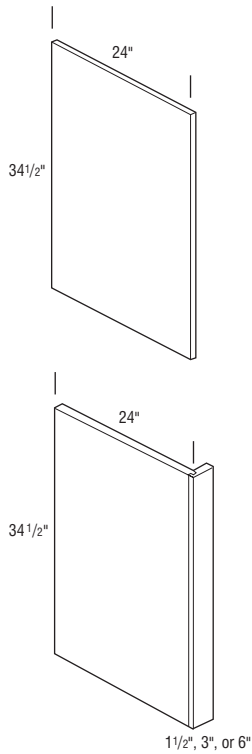

Model	Price
BEPWD	274
• 3/4" two-sided veneer panel with front edgebanded.	
BEPF1.5WD	223
BEPF3WD	279
BEPF6WD	356

- 1/2" wood veneer with face frame attached.
- Notes below apply to all products in section above:**
- Increased Depths available in 1/4" increments from 24 1/4" to 48".
 - Reduced Depths available in 1/4" increments from 12 1/4" to 23 3/4".
 - Increased Heights available in 1/4" increments from 34 3/4" to 48".
 - Reduced Heights available in 1/4" increments from 12" to 34 1/4".
 - Increased Widths available in 1/4" increments. See page G•46 for details.
 - Glazes and/or Techniques available: F, P, TW, XTW, HW, XHW.

End Panel Options

AUTH ¹	CSFPE ²	FL/FR	FPE ²	INTGE ²	IPE ²
✓	✓		✓	✓	✓

Custom Modification Options

BVR	EX	FLUT ³	ID	IH	IW ⁴	RD	RH	ROSLUT ³	WTR ²
		✓	✓	✓	✓	✓	✓	✓	✓

¹ Not available with authentic flush ends both.

² Not available on BEPWD.

³ Not available on BEPWD or BEPF1.5WD with fluting both.

⁴ Only available in BEPF1.5WD and BEPF3WD.

Description

ANGLED WALL END PANELS, 3"

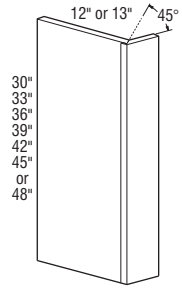

Left Shown

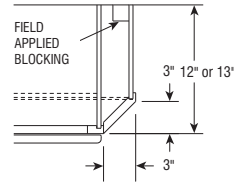

Right Shown

Model	Price
45WEP330	234
45WEP333	280
45WEP336	325
45WEP339	348
45WEP342	368
45WEP345	388
45WEP348	407

- Finished Ends standard.
- 1/2" wood veneer with face frame attached.
- Return not available.
- Inset and Beaded Inset styles are a standard 13" deep.
- Full Overlay Styles:
 - Increased Depths available in 1/4" increments from 12 1/4" to 36".
 - Reduced Depths available in 1/4" increments from 6" to 11 3/4".
- Inset and Beaded Inset Styles:
 - Increased Depths available in 1/4" increments from 13 1/4" to 24".
 - Reduced Depths available in 1/4" increments from 6" to 12 3/4".
- Glazes and/or Techniques available: F, P, TW, XTW, HW, XHW.

End Panel Options

AUTH	CSFPE	FL/FR	FPE	INTGE	IPE
✓			✓		

Custom Modification Options

BVR	EX	FLUT ¹	ID	IH	IW	RD	RH	ROSLUT ²	WTR
		✓	✓	✓	✓	✓	✓	✓	✓

¹ Not available with 6" fluting or fluting both.

² Only available on ROSFLUT3CTR.

Glazes and Techniques

F = Flooded (see page E•4.)

P = Penned (see page E•4.)

TW = Timeworn (see page E•4.)

XTW = Extra Timeworn (see page E•4.)

HW = Hewn (see page E•4.)

XHW = Extra Hewn (see page E•4.)

Description	Model	Price
ANGLED BASE END PANEL	45BEP	400

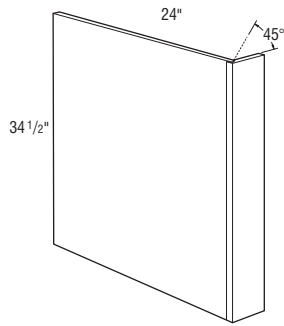

Left Shown

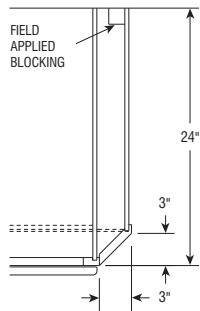

Right Shown

- Finished Ends standard.
- Toekick not available.
- Increased Depths available in 1/4" increments from 24 1/4" to 48".
- Reduced Depths available in 1/4" increments from 12 1/4" to 23 3/4".
- Increased Heights available in 1/4" increments from 34 3/4" to 48".
- Reduced Heights available in 1/4" increments from 12" to 34 1/4".
- Glazes and/or Techniques available:
F, P, TW, XTW, HW, XHW.

End Panel Options

AUTH ¹	CSFPE	FL/FR	FPE	INTGE	IPE
<input checked="" type="checkbox"/>	<input checked="" type="checkbox"/>	<input checked="" type="checkbox"/>	<input checked="" type="checkbox"/>	<input checked="" type="checkbox"/>	<input checked="" type="checkbox"/>

Custom Modification Options

BVR	EX	FLUT ²	ID	IH	IW	RD	RH	ROSFLUT	WTR
<input checked="" type="checkbox"/>	<input checked="" type="checkbox"/>	<input checked="" type="checkbox"/>	<input checked="" type="checkbox"/>	<input checked="" type="checkbox"/>	<input checked="" type="checkbox"/>	<input checked="" type="checkbox"/>	<input checked="" type="checkbox"/>	<input checked="" type="checkbox"/>	<input checked="" type="checkbox"/>

¹ Not available with authentic flush ends both.
² Not available with fluting both or 6" fluting.

Description	Model	Price
ANGLED TALL END PANELS	45STEP384	951
	45STEP387	984
	45STEP390	1020
	45STEP393	1057
	45STEP396	1089

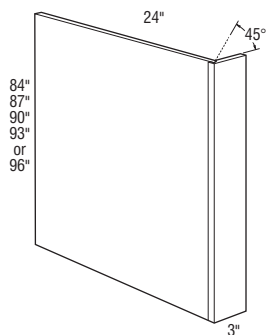

Left Shown

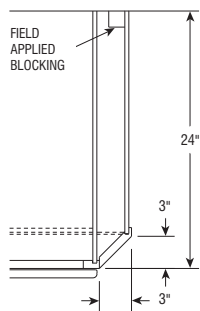

Right Shown

- 1/2" wood veneer with face frame attached.
- Toekick not available.
- Increased Depths available in 1/4" increments from 24 1/4" to 29 1/4".
- Reduced Depths available in 1/4" increments from 6" to 23 3/4".
- Glazes and/or Techniques available:
F, P, TW, XTW, HW, XHW.

End Panel Options

AUTH ¹	CSFPE	FL/FR	FPE	INTGE	IPE
<input checked="" type="checkbox"/>	<input checked="" type="checkbox"/>	<input checked="" type="checkbox"/>	<input checked="" type="checkbox"/>	<input checked="" type="checkbox"/>	<input checked="" type="checkbox"/>

Custom Modification Options

BVR	EX	FLUT ²	ID	IH ³	IW	RD	RH	ROSFLUT	WTR
<input checked="" type="checkbox"/>	<input checked="" type="checkbox"/>	<input checked="" type="checkbox"/>	<input checked="" type="checkbox"/>	<input checked="" type="checkbox"/>	<input checked="" type="checkbox"/>	<input checked="" type="checkbox"/>	<input checked="" type="checkbox"/>	<input checked="" type="checkbox"/>	<input checked="" type="checkbox"/>

¹ Not available with authentic flush ends both.
² Not available with fluting both or 6" fluting.

Description	Model	Price
END PANELS – FULL OVERLAY STYLES ONLY	WEPOF3WD	261

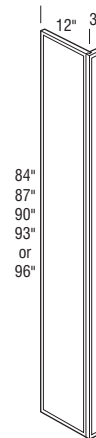
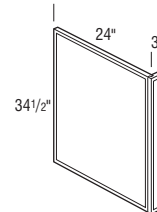
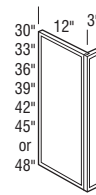

- Return not available.
- | Model | Price |
|-------------------|-------|
| WEPOF333WD | 290 |
| WEPOF336WD | 312 |
| WEPOF339WD | 342 |
| WEPOF342WD | 368 |
| WEPOF345WD | 392 |
| WEPOF348WD | 418 |
- Must specify a profile.
 - Full overlay styles with #18 profile will be sent with #14 profile.
 - Increased Depths available in 1/4" increments from 12 1/4" to 36".
 - Reduced Depths available in 1/4" increments from 6" to 11 3/4".
 - Reduced Heights available in 1/4" increments from 12" to 47 3/4".
 - Increased Widths available in 1/4" increments. See page G•46 for details.
 - Not available with Inset or Beaded Inset Styles.

Model	Price
BEPOF3WD	538

- Must specify a profile.
- Full overlay styles with #18 profile will be sent with #14 profile.
- Toekick not included with BEPOF3WD.
- Increased Depths available in 1/4" increments from 24 1/4" to 48".
- Reduced Depths available in 1/4" increments from 12 1/4" to 23 3/4".
- Increased Heights available in 1/4" increments from 34 3/4" to 48".
- Reduced Heights available in 1/4" increments from 12" to 34 1/4".
- Increased Widths available in 1/4" increments. See page G•46 for details.
- Not available with Inset or Beaded Inset Styles.

Model	Price
TEP1284OF3WD	522
TEP1287OF3WD	563
TEP1290OF3WD	609
TEP1293OF3WD	662
TEP1296OF3WD	714

- Must specify a profile.
- Full overlay styles with #18 profile will be sent with #14 profile.
- Toekick not included with TEP1284OF3WD.
- Increased Depths available in 1/4" increments from 12 1/4" to 36".
- Reduced Depths available in 1/4" increments from 6" to 11 3/4".
- Reduced Heights available in 1/4" increments from 60" to 95 3/4".
- Increased Widths available in 1/4" increments. See page G•46 for details.
- Not available with Inset or Beaded Inset Styles.

End Panel Options

AUTH ¹	CSFPE	FL/FR	FPE	INTGE	IPE
<input checked="" type="checkbox"/>	<input checked="" type="checkbox"/>	<input checked="" type="checkbox"/>	<input checked="" type="checkbox"/>	<input checked="" type="checkbox"/>	<input checked="" type="checkbox"/>

Custom Modification Options

BVR	EX	FLUT	ID ²	IH ³	IW	RD	RH	ROSFLUT	WTR
<input checked="" type="checkbox"/>	<input checked="" type="checkbox"/>	<input checked="" type="checkbox"/>	<input checked="" type="checkbox"/>	<input checked="" type="checkbox"/>	<input checked="" type="checkbox"/>	<input checked="" type="checkbox"/>	<input checked="" type="checkbox"/>	<input checked="" type="checkbox"/>	<input checked="" type="checkbox"/>

¹ Not available with authentic flush ends both.
² Not available with TEP versions.
³ Only available on WEPOF348WD and BEPOF348WD.

Glazes and Techniques

- F** = Flooded (see page E•4.)
- P** = Penned (see page E•4.)
- TW** = Timeworn (see page E•4.)
- XTW** = Extra Timeworn (see page E•4.)
- HW** = Hewn (see page E•4.)
- XHW** = Extra Hewn (see page E•4.)

Fillers & Panels

Description

END PANELS – FULL OVERLAY STYLES ONLY

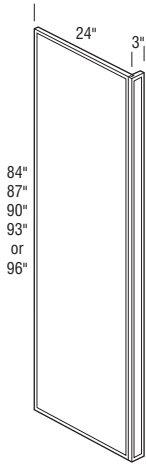

Model	Price
TEP2484OF3WD	809
TEP2487OF3WD	873
TEP2490OF3WD	946
TEP2493OF3WD	1019
TEP2496OF3WD	1103

- 1/2" wood veneer with face frame attached.
- Must specify a profile.
- Full Overlay styles with #18 profile will have overlay set with #14 profile.
- Overlays profiled on all four sides.
- Toekick not included with TEP2484OF3WD.
- Increased Depths available in 1/4" increments from 24 1/4" to 48".
- Reduced Depths available in 1/4" increments from 12 1/4" to 23 3/4".
- Reduced Heights available in 1/4" increments from 60" to 95 3/4".
- Increased Widths available in 1/4" increments. See page G•46 for details.
- Not available with Inset or Beaded Inset Styles.

End Panel Options

AUTH ¹	CSFPE	FL/FR	FPE	INTGE	IPE
✓	✓	✓	✓	✓	✓

Custom Modification Options

BVR	EX	FLUT	ID	IH	IW	RD	RH	ROSFLUT ²	WTR
✓	✓	✓	✓	✓	✓	✓	✓	✓	✓

¹ Not available with authentic flush ends both.

REFRIGERATOR PANEL, 12" DEEP

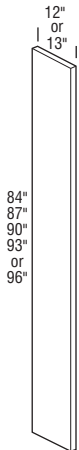

TEP1284WD	390
TEP1287WD	426
TEP1290WD	456
TEP1293WD	444
TEP1296WD	493

- 3/4" double-sided veneer panel with front edgebanded.
- Reduced Heights available in 1/4" increments from 60" to 95 3/4".
- Inset and Beaded Inset styles are a standard 13" deep.
- Full Overlay Styles:
 - Reduced Depths available in 1/4" increments from 6" to 11 3/4".
- Inset and Beaded Inset Styles:
 - Reduced Depths available in 1/4" increments from 6" to 12 3/4".

End Panel Options

AUTH ¹	CSFPE	FL/FR	FPE	INTGE	IPE
✓					

Custom Modification Options

BVR	EX	FLUT	ID	IH	IW	RD	RH	ROSFLUT ²	WTR
✓	✓	✓	✓	✓	✓	✓	✓	✓	✓

¹ Not available with authentic flush ends both.

Description

REFRIGERATOR PANEL, 12" or 13" DEEP

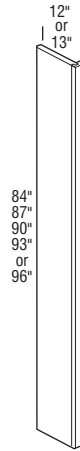

Model	Price
TEP1284F1.5WD	445
TEP1284F3WD	497
TEP1284F6WD	622

TEP1287F1.5WD	455
TEP1287F3WD	507
TEP1287F6WD	635

TEP1290F1.5WD	466
TEP1290F3WD	517
TEP1290F6WD	647

TEP1293F1.5WD	476
TEP1293F3WD	523
TEP1293F6WD	651

TEP1296F1.5WD	476
TEP1296F3WD	527
TEP1296F6WD	658

- 1/2" wood veneer with face frame attached.
- Reduced Heights available in 1/4" increments from 60" to 95 3/4".
- Increased Widths available in 1/4" increments. See page G•46 for details.
- Inset and Beaded Inset styles are a standard 13" deep.
- Full Overlay Styles:
 - Reduced Depths available in 1/4" increments from 6" to 11 3/4".
- Inset and Beaded Inset Styles:
 - Reduced Depths available in 1/4" increments from 6" to 12 3/4".

End Panel Options

AUTH ¹	CSFPE	FL/FR	FPE	INTGE	IPE
✓	✓	✓	✓	✓	✓

Custom Modification Options

BVR	EX	FLUT ²	ID	IH	IW ³	RD	RH	ROSFLUT ²	WTR
✓	✓	✓	✓	✓	✓	✓	✓	✓	✓

¹ Not available with authentic flush ends both.

² Not available on 1.5" wide or with fluting both.

³ Not available on 6" wide.

Description	Model	Price
REFRIGERATOR PANEL, 12" or 13" DEEP	TEP12102WD	815
	TEP12108WD	1137
	TEP12120WD	1201

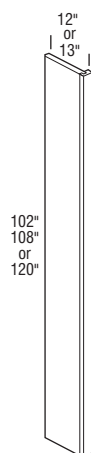
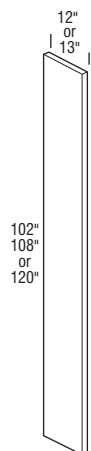

- 3/4" double-sided veneer panel with front edgebanded.
- Inset and Beaded Inset styles are a standard 13" deep.
- Full Overlay Styles:
 - Reduced Depths available in 1/4" increments from 6" to 11 3/4".
- Inset and Beaded Inset Styles:
 - Reduced Depths available in 1/4" increments from 6" to 12 3/4".
- Reduced Heights available in 1/4" increments from 96 1/4" to 119 3/4".
- All panels over 96" high will get three equal height authentic doors when authentic is ordered.

TEP12102F1.5WD	816
TEP12102F3WD	851
TEP12108F1.5WD	1156
TEP12108F3WD	1175

TEP12120F1.5WD	1217
TEP12120F3WD	1233

- 5/8" standard finished flushed ends. Wood veneer with face frame attached.
- Inset and Beaded Inset styles are a standard 13" deep.
- Full Overlay Styles:
 - Reduced Depths available in 1/4" increments from 6" to 11 3/4".
- Increased Widths available in 1/4" increments. See page G•46 for details.
- Inset and Beaded Inset Styles:
 - Reduced Depths available in 1/4" increments from 6" to 12 3/4".
- Reduced Heights available in 1/4" increments from 96 1/4" to 119 3/4".

End Panel Options

AUTH ¹	CSFPE	FL/FR	FPE	INTGE	IPE ²
<input checked="" type="checkbox"/>	<input type="checkbox"/>	<input type="checkbox"/>	<input type="checkbox"/>	<input type="checkbox"/>	<input checked="" type="checkbox"/>

Custom Modification Options

BVR	EX	FLUT ³	ID	IH	IW ⁴	RD	RH	ROSFLUT ⁵	WTR ⁶
<input type="checkbox"/>	<input type="checkbox"/>	<input checked="" type="checkbox"/>	<input type="checkbox"/>	<input type="checkbox"/>	<input checked="" type="checkbox"/>	<input checked="" type="checkbox"/>	<input checked="" type="checkbox"/>	<input checked="" type="checkbox"/>	<input checked="" type="checkbox"/>

¹ Not available with authentic flush ends both.

² Only available on 1.5 and 3 versions.

³ Only available with 3" wide. Not available with 6" fluting or fluting both.

⁴ Not available on TEP12108WD or TEP121208WD.

⁵ Only available with 3" wide. Not available with fluting both.

⁶ Only available in TEP12108F1.5WD and TEP12108F3WD.

Description	Model	Price
REFRIGERATOR PANEL, 24" DEEP	TEP2484WD	670
	TEP2487WD	684
	TEP2490WD	760
	TEP2493WD	763
	TEP2496WD	841

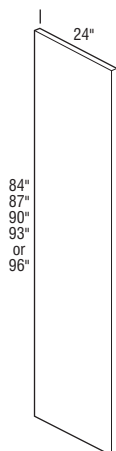

- 3/4" double-sided veneer panel with front edgebanded.
- Increased Depths available in 1/4" increments from 24 1/4" to 48".
- Reduced Depths available in 1/4" increments from 12 1/4" to 23 3/4".
- Reduced Height available in 1/4" increments from 60" to 95 3/4".

End Panel Options

AUTH ¹	CSFPE	FL/FR	FPE	INTGE	IPE
<input checked="" type="checkbox"/>	<input type="checkbox"/>	<input type="checkbox"/>	<input type="checkbox"/>	<input type="checkbox"/>	<input type="checkbox"/>

Custom Modification Options

BVR	EX	FLUT	ID	IH	IW	RD	RH	ROSFLUT	WTR
<input type="checkbox"/>	<input type="checkbox"/>	<input checked="" type="checkbox"/>	<input type="checkbox"/>	<input type="checkbox"/>	<input checked="" type="checkbox"/>	<input checked="" type="checkbox"/>	<input checked="" type="checkbox"/>	<input checked="" type="checkbox"/>	<input checked="" type="checkbox"/>

¹ Not available with authentic flush ends both.

TEP2484F1.5WD	641
TEP2484F3WD	670
TEP2484F6WD	838
TEP2487F1.5WD	716
TEP2487F3WD	739
TEP2487F6WD	894

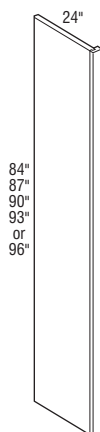

TEP2490F1.5WD	726
TEP2490F3WD	760
TEP2490F6WD	951

TEP2493F1.5WD	805
TEP2493F3WD	816
TEP2493F6WD	1003

TEP2496F1.5WD	800
TEP2496F3WD	841
TEP2496F6WD	1053

- 1/2" wood veneer with face frame attached.
- Increased Depths available in 1/4" increments from 24 1/4" to 48".
- Reduced Depths available in 1/4" increments from 12 1/4" to 23 3/4".
- Reduced Height available in 1/4" increments from 60" to 95 3/4".
- Increased Widths available in 1/4" increments. See page G•46 for details.

End Panel Options

AUTH ¹	CSFPE	FL/FR	FPE	INTGE	IPE
<input checked="" type="checkbox"/>	<input type="checkbox"/>	<input type="checkbox"/>	<input type="checkbox"/>	<input type="checkbox"/>	<input type="checkbox"/>

Custom Modification Options

BVR	EX	FLUT ²	ID	IH	IW ³	RD	RH	ROSFLUT ²	WTR
<input type="checkbox"/>	<input type="checkbox"/>	<input checked="" type="checkbox"/>	<input type="checkbox"/>	<input type="checkbox"/>	<input checked="" type="checkbox"/>	<input checked="" type="checkbox"/>	<input checked="" type="checkbox"/>	<input checked="" type="checkbox"/>	<input checked="" type="checkbox"/>

¹ Not available with authentic flush ends both.

² Not available on 1.5" wide or with fluting both.

³ Not available on 6" wide.

Fillers & Panels

Description	Model	Price
REFRIGERATOR PANEL, 24" DEEP	TEP24102WD	989
	TEP24108WD	1357
	TEP24120WD	1425

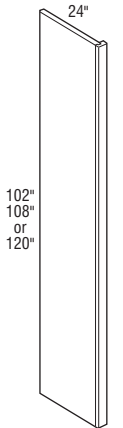
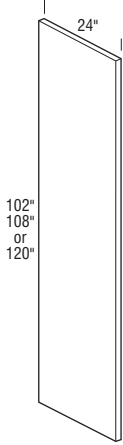

- 3/4" double-sided veneer panel with front edgebanded.
- Increased Depths available in 1/4" increments from 24 1/4" to 30"
- Reduced Depths available in 1/4" increments from 12 1/4" to 23 3/4"
- Reduced Heights available in 1/4" increments from 96 1/4" to 119 3/4"
- All panels over 96" high will get three equal height authentic doors when authentic is ordered.

TEP24102F1.5WD	1090
TEP24102F3WD	1122

TEP24108F1.5WD	1380
TEP24108F3WD	1402

TEP24120F1.5WD	1441
TEP24120F3WD	1458

- 5/8" standard finished flushed ends. Wood veneer with face frame attached.
- Increased Depths available in 1/4" increments from 24 1/4" to 30"
- Reduced Depths available in 1/4" increments from 12 1/4" to 23 3/4"
- Reduced Heights available in 1/4" increments from 96 1/4" to 119 3/4"
- Increased Widths available in 1/4" increments. See page G-46 for details.

End Panel Options					
AUTH ¹	CSFPE	FL/FR	FPE ²	INTGE	IPE ³
<input checked="" type="checkbox"/>	<input type="checkbox"/>	<input type="checkbox"/>	<input checked="" type="checkbox"/>	<input type="checkbox"/>	<input checked="" type="checkbox"/>

Custom Modification Options									
BVR	EX	FLUT ⁴	ID	IH	IW ⁵	RD	RH	ROSFLUT ⁶	WTR ⁷
<input checked="" type="checkbox"/>	<input checked="" type="checkbox"/>	<input checked="" type="checkbox"/>	<input checked="" type="checkbox"/>	<input checked="" type="checkbox"/>	<input checked="" type="checkbox"/>	<input checked="" type="checkbox"/>	<input checked="" type="checkbox"/>	<input checked="" type="checkbox"/>	<input checked="" type="checkbox"/>

¹ Not available with authentic flush ends both.
² Only available on TEP24108F1.5WD and TEP24108F3WD.
³ Only available on 1.5 and 3 versions.
⁴ Only available with 3" wide. Not available with 6" fluting or fluting both.
⁵ Not available on TEP24108WD or TEP24120WD.
⁶ Only available with 3" wide. Not available with fluting both.
⁷ Only available on TEP24108WD, TEP24108F1.5WD and TEP24108F3WD.

Description	Model	Price
3/32" SKINS	WEPS18	118
	WEPS30	124
	WEPS33	128
	WEPS36	129
	WEPS39	133
	WEPS42	138
	WEPS45	141
	WEPS48	146
	BEPS34.5	214
	VEPS30	182

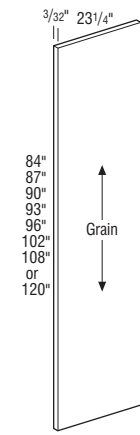
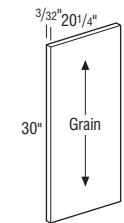
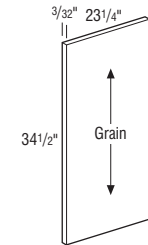
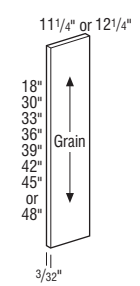

- 3/32" thick.
- Inset and Beaded Inset will have a standard depth of 12 1/4"
- Increased Heights available in 1/4" increments from 48 1/4" to 60"
- Reduced Heights available in 1/4" increments from 12" to 47 3/4"
- Full Overlay Styles:
 - Increased Depths available in 1/4" increments from 11 1/2" to 47 3/4"
 - Reduced Depths available in 1/4" increments from 6" to 11"
- Inset and Beaded Inset Styles:
 - Increased Depths available in 1/4" increments from 12 1/2" to 47 3/4"
 - Reduced Depths available in 1/4" increments from 6" to 12"

BEPS34.5	214
-----------------	-----

- 3/32" thick.
- Increased Heights available in 1/4" increments from 34 3/4" to 59 3/4"
- Reduced Heights available in 1/4" increments from 12" to 34 1/4"
- Increased Depths available in 1/4" increments from 23 1/2" to 48"
- Reduced Depths available in 1/4" increments from 12 1/4" to 23"

VEPS30	182
---------------	-----

- 3/32" thick.
- Increased Heights available in 1/4" increments from 30 1/4" to 59 3/4"
- Reduced Heights available in 1/4" increments from 12" to 29 3/4"
- Increased Depths available in 1/4" increments from 20 1/2" to 48"
- Reduced Depths available in 1/4" increments from 12 1/4" to 20"

TEPS84	337
TEPS87	351
TEPS90	365
TEPS93	372
TEPS96	376
TEPS102	384
TEPS108	391
TEPS120	408

- 3/32" thick.
- Reduced Heights available in 1/4" increments from 60" to 119 3/4"
- Increased Depths available in 1/4" increments from 23 1/2" to 29 1/4"
- Reduced Depths available in 1/4" increments from 6" to 23"

End Panel Options					
AUTH ¹	CSFPE	FL/FR	FPE	INTGE	IPE
<input checked="" type="checkbox"/>	<input type="checkbox"/>	<input type="checkbox"/>	<input type="checkbox"/>	<input type="checkbox"/>	<input type="checkbox"/>

Custom Modification Options									
BVR	EX	FLUT	ID ²	IH ³	IW	RD ²	RH	ROSFLUT	WTR
<input checked="" type="checkbox"/>	<input checked="" type="checkbox"/>	<input checked="" type="checkbox"/>	<input checked="" type="checkbox"/>	<input checked="" type="checkbox"/>	<input checked="" type="checkbox"/>	<input checked="" type="checkbox"/>	<input checked="" type="checkbox"/>	<input checked="" type="checkbox"/>	<input checked="" type="checkbox"/>

¹ Not available with authentic flush ends both. Not available on WEPS or BEPS34.5.
² Not available on WEPS45 or WEPS48.
³ Only available on WEPS48, BEPS34.5, and VEPS30.

Description	Model	Price
ENGLISH COUNTRY CAR SIDING SKINS		
	WEPS18VG Wall Cabinet Paneling	90
	WEPS30VG Wall Cabinet Paneling	144
	WEPS42VG Wall Cabinet Paneling	202
	• 3/16" thick.	
	VEPS30VG Vanity Cabinet Paneling	274
	BEPS34.5VG Base Cabinet Paneling	337
	• 3/16" thick.	
	TEPS2484VG Utility Paneling	805
	TEPS2496VG Utility Paneling	907
	• 3/16" thick.	
	TB8WD14	96
	• 1/4" thick.	
	Modifications Are Not Available	

End Panel Options

<input checked="" type="checkbox"/>	<input type="checkbox"/>	<input type="checkbox"/>	<input type="checkbox"/>	<input type="checkbox"/>	<input type="checkbox"/>	<input type="checkbox"/>
AUTH ¹	CSFPE	FL/FR	FPE	INTGE	IPE	

Custom Modification Options

<input checked="" type="checkbox"/>	<input type="checkbox"/>	<input type="checkbox"/>	<input type="checkbox"/>	<input type="checkbox"/>	<input type="checkbox"/>	<input type="checkbox"/>	<input type="checkbox"/>	<input type="checkbox"/>	
BVR	EX	FLUT	ID ²	IH	IW	RD ²	RH ³	ROSLUT	WTR

¹ Only available in VEPS and TEPS versions. Not available with authentic flush ends both.
² Only available on WEPS18VG and WEPS30VG.
³ Only available on WEPS30VG.

Description	Model	Price
TOEKICK CAPS	TKC	71
	• Price per pair. • Available in Alder and Maple. • Cherry finishes available on Maple.	
	Modifications Are Not Available	

DESCRIPTION	Model	Price
PANELING		
	WP9630WD • 1/4" x 96" x 30"	578
	BP3634.5WD • 1/4" x 36" x 34 1/2"	287
	BP4834.5WD • 1/4" x 48" x 34 1/2"	363
	BP7234.5WD • 1/4" x 72" x 34 1/2"	512
	BP9634.5WD • 1/4" x 96" x 34 1/2"	658
	BP9648CRSGR • 1/4" x 96" x 48"	945
	BP4896WD • 1/4" x 48" x 96"	839
	• 1/4" thick.	
	Modifications Are Not Available	

Description	Model	Price
ENGLISH COUNTRY CAR SIDING PANELING		
	WEP4830VG Wall Cabinet Paneling	577
	BP4834.5VG Base Cabinet Paneling	664
	BP4896VG Tall Cabinet Paneling	1396
	Modifications Are Not Available	

Fillers & Panels

Description	Model	Price
-------------	-------	-------

DISHWASHER PANEL **DWPWD** 177

- Dimensions: 1/4" x 24" x 30"

Modifications Are Not Available

LAZY SUSAN BASE PANEL **BLSBPWD** 258

- Dimensions: 3/8" x 23 1/4" x 34 1/2"

Modifications Are Not Available

TAPERED VANITY END PANEL, 21" DEEP **VDL2130WD** 311
VDL2132WD 311

- 3/4" double sided veneer panel with front edgebanded.
- Increased Depths available in 3" increments to 24".
- Reduced Depths available in 3" increments to 18".
- Increased Height available in 1/4" increments from 30 1/4" to 46 1/2".

End Panel Options: AUTH CSFPE FL/FR FPE INTGE IPE

Custom Modification Options: BVR EX FLUT ID IH IW RD RH ROSFLUT WTR

HUTCH END PANEL **HE48** 571

- 3/4" thick.
- Increased Heights available in 1/4" increments from 48 1/4" to 60".
- Reduced Heights available in 1/4" increments from 36" to 47 3/4".

End Panel Options: AUTH CSFPE FL/FR FPE INTGE IPE

Custom Modification Options: BVR EX FLUT ID IH IW RD RH ROSFLUT WTR

Description	Model	Price
-------------	-------	-------

MATERIAL (SPECIFY STAIN and STYLE) **WNRMAT** 114

CRISS CROSS WINE RACK MATERIAL

- Price is per square foot.
- Includes front and back grid.
- Specify width and height.
- Maximum width/height is 30" when the width/height exceeds 30".
- Minimum width is 15". Maximum width is 48".
- Minimum height is 15". Maximum height is 48".

End Panel Options: AUTH

Custom Modification Options: BAND BND F.ALL F.FRT PRO

1/2" NATURAL MATERIAL – 2-SIDED **1/2NAT2S** 60

- Price is per square foot.
- Cabinet top and bottom material.
- Specify width and height.
- Minimum width is 1 1/2". Maximum width is 48".
- Minimum height is 3". Maximum height is 96".

End Panel Options: AUTH

Custom Modification Options: BAND BND F.ALL F.FRT PRO

3/4" NATURAL MATERIAL – 2-SIDED **3/4NAT2S** 65

- Price is per square foot.
- Specify width and height.
- Shelving material.
- Minimum width is 1 1/2". Maximum width is 48".
- Minimum height is 3". Maximum height is 96".

End Panel Options: AUTH

Custom Modification Options: BAND BND F.ALL F.FRT PRO

3/16" NATURAL MATERIAL – 1-SIDED **3/16NAT1S** 42

- Price is per square foot.
- Specify width and height.
- Minimum width is 1 1/2". Maximum width is 48".
- Minimum height is 3". Maximum height is 96".

Modifications Are Not Available

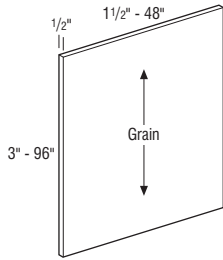
Description	Model	Price
1/2" NATURAL – 1 SIDE, VENEER – 1 SIDE	1/2NATVEN	60
	<ul style="list-style-type: none"> • Price is per square foot. • Specify width and height. • Minimum width is 1 1/2". Maximum width is 48". • Minimum height is 3". Maximum height is 96". 	<div style="border: 1px solid black; padding: 5px; width: fit-content;">Modifications Are Not Available</div>

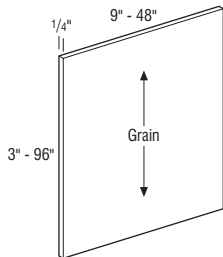
1/4" VENEER – 1-SIDED	1/4VEN1S	41
	<ul style="list-style-type: none"> • Price is per square foot. • Specify width and height. • Minimum width is 9". Maximum width is 48". • Minimum height is 3". Maximum height is 96". • 48" W x 96" H or 96" W x 48" H 	<div style="border: 1px solid black; padding: 5px; width: fit-content;">Modifications Are Not Available</div>

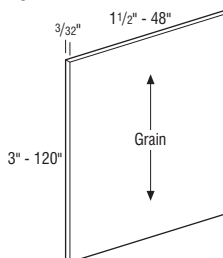
3/32" VENEER – 1-SIDED	3/32VEN1S	41
	<ul style="list-style-type: none"> • Price is per square foot. • Specify width and height. • Minimum width is 1 1/2". Maximum width is 48". • Minimum height is 3". Maximum height is 120". • 48" W x 48" H or 29 1/4" W x 120" H 	<div style="border: 1px solid black; padding: 5px; width: fit-content;">Modifications Are Not Available</div>

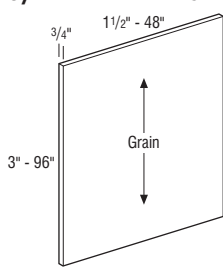
3/4" VENEER – 2-SIDED	3/4VEN2S	65										
	<ul style="list-style-type: none"> • Price is per square foot. • Specify width and height. • Minimum width is 1 1/2". Maximum width is 48". • Minimum height is 3". Maximum height is 96". 	<div style="border: 1px solid black; padding: 5px; width: fit-content;">Modifications Are Not Available</div> <div style="margin-top: 10px;"> <p style="text-align: right; font-size: small;">End Panel Options</p> <div style="border: 1px solid black; padding: 2px; width: fit-content; margin: 0 auto;">AUTH</div> <p style="text-align: right; font-size: x-small;">Custom Modification Options</p> <table border="1" style="margin: 0 auto; border-collapse: collapse;"> <tr> <td style="padding: 2px;">BAND</td> <td style="padding: 2px;">BND</td> <td style="padding: 2px;">F.ALL</td> <td style="padding: 2px;">F.FRT</td> <td style="padding: 2px;">PRO</td> </tr> <tr> <td style="text-align: center;"><input checked="" type="checkbox"/></td> <td style="text-align: center;"><input type="checkbox"/></td> <td style="text-align: center;"><input type="checkbox"/></td> <td style="text-align: center;"><input type="checkbox"/></td> <td style="text-align: center;"><input type="checkbox"/></td> </tr> </table> </div>	BAND	BND	F.ALL	F.FRT	PRO	<input checked="" type="checkbox"/>	<input type="checkbox"/>	<input type="checkbox"/>	<input type="checkbox"/>	<input type="checkbox"/>
BAND	BND	F.ALL	F.FRT	PRO								
<input checked="" type="checkbox"/>	<input type="checkbox"/>	<input type="checkbox"/>	<input type="checkbox"/>	<input type="checkbox"/>								

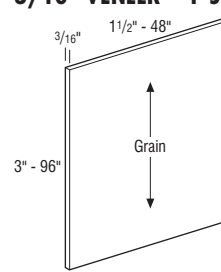
Description	Model	Price
3/16" VENEER – 1-SIDED	3/16VEN1S	42
	<ul style="list-style-type: none"> • Price is per square foot. • Specify width and height. • Minimum width is 1 1/2". Maximum width is 48". • Minimum height is 3". Maximum height is 96". 	<div style="border: 1px solid black; padding: 5px; width: fit-content;">Modifications Are Not Available</div>

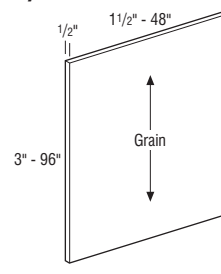
1/2" VENEER – 2-SIDED	1/2VEN2S	60										
	<ul style="list-style-type: none"> • Price is per square foot. • Specify width and height. • Minimum width is 1 1/2". Maximum width is 48". • Minimum height is 3". Maximum height is 96". 	<div style="border: 1px solid black; padding: 5px; width: fit-content;">Modifications Are Not Available</div> <div style="margin-top: 10px;"> <p style="text-align: right; font-size: small;">End Panel Options</p> <div style="border: 1px solid black; padding: 2px; width: fit-content; margin: 0 auto;">AUTH</div> <p style="text-align: right; font-size: x-small;">Custom Modification Options</p> <table border="1" style="margin: 0 auto; border-collapse: collapse;"> <tr> <td style="padding: 2px;">BAND</td> <td style="padding: 2px;">BND</td> <td style="padding: 2px;">F.ALL</td> <td style="padding: 2px;">F.FRT</td> <td style="padding: 2px;">PRO</td> </tr> <tr> <td style="text-align: center;"><input checked="" type="checkbox"/></td> <td style="text-align: center;"><input type="checkbox"/></td> <td style="text-align: center;"><input type="checkbox"/></td> <td style="text-align: center;"><input type="checkbox"/></td> <td style="text-align: center;"><input type="checkbox"/></td> </tr> </table> </div>	BAND	BND	F.ALL	F.FRT	PRO	<input checked="" type="checkbox"/>	<input type="checkbox"/>	<input type="checkbox"/>	<input type="checkbox"/>	<input type="checkbox"/>
BAND	BND	F.ALL	F.FRT	PRO								
<input checked="" type="checkbox"/>	<input type="checkbox"/>	<input type="checkbox"/>	<input type="checkbox"/>	<input type="checkbox"/>								

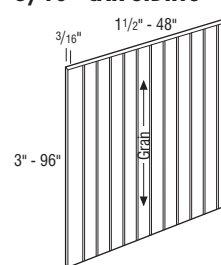
3/16" CAR SIDING – 1-SIDED	3/16CSDG1S	76
	<ul style="list-style-type: none"> • Price is per square foot. • Specify width and height. • Minimum width is 1 1/2". Maximum width is 48". • Minimum height is 3". Maximum height is 96". 	<div style="border: 1px solid black; padding: 5px; width: fit-content;">Modifications Are Not Available</div>

Description	Model	Price
-------------	-------	-------

DOOR RAIL MATERIAL

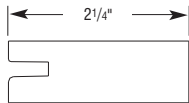

Karis Door Rail

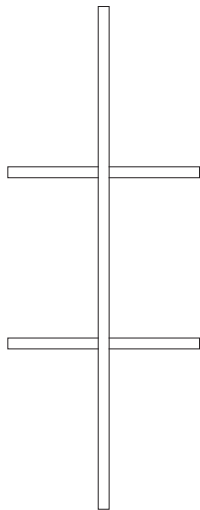

MUNTIN

CGRAIL Door Rail Material	82
DRWRAILEND Drawer Rail	82
DRWRAILCROSS Drawer	82
DRRAILEND Door Rail	82
DRRAILCROSS Door Rail	82

- Price is per lineal foot.
- Specify door style and length.
- Not available on the following door styles: Langley, Langley Beaded Inset, and Langley Inset.
- **CGRAIL, DRWRAILEND, DRRAILEND:** Minimum height is 6". Maximum height is 72".
- **DRWRAILCROSS, DRRAILCROSS:** Minimum height is 6". Maximum height is 36".

MUNTIN Mullion door material	42
-------------------------------------	----

- Price is per lineal foot.
- Specify door style and length.
- Not available with the following door styles: Brooks, Brooks Beaded Inset, Brooks Inset, Daxton, Daxton Beaded Inset, Daxton Inset, Wells, Langley, Langley Beaded Inset, Langley Inset, Trystan, Trystan Beaded Inset, Trystan Inset, Tackett, Tackett Beaded Inset, and Tackett Inset.

End Panel Options

AUTH

Custom Modification Options

BAND	BND	F.ALL ¹	F.FRT	PRO
		✓		

¹ Not available on MUNTIN.

FRAME RAIL MATERIAL

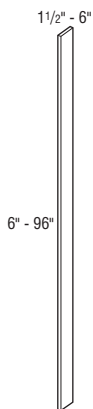

FFRAIL	82
---------------	----

- Price is per lineal foot.
- Specify length.
- Minimum width is 1 1/2". Maximum width is 6".
- Minimum height is 6". For rails 1 1/2" up to 3" wide, the maximum height is 120". For rails greater than 3" to 6" wide, the maximum height is 96".

End Panel Options

AUTH

Custom Modification Options

BAND	BND	F.ALL	F.FRT	PRO
		✓		

Description	Model	Price
-------------	-------	-------

CORNER TALL MOULDING

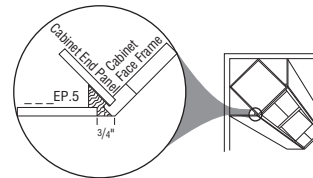
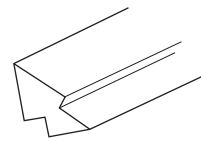

Section enlarged to show detail.

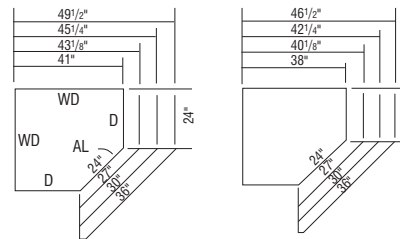

AL = Angle Length
D = Depth

AL = WD - D

.7071

AL = WD - D

.7071

- For use with Corner End Panel (84TCEP.5, 96TCEP.5, BEP.5WD, 30WEP.5, 42WEP.5) in 45° diagonal installation.
- DCM10 is not available in Quartersawn Oak.

End Panel Options

AUTH

Custom Modification Options

BAND	BND	F.ALL ¹	F.FRT	PRO
		✓		

¹ Only available on DCM10.

CORNER END PANELS

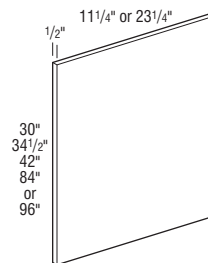

30WEP.5	144
----------------	-----

42WEP.5	177
----------------	-----

- Wall Corner End Panel

BEP.5WD	258
----------------	-----

- Base Corner End Panel

84TCEP.5	450
-----------------	-----

96TCEP.5	499
-----------------	-----

- Tall Corner End Panel

Notes below apply to all products in section above:

- 1/2" veneer.
- For use with DCM7 and DCM8 in 45° diagonal installation. See diagram under Corner Tall Moulding section for DCM__ usage.

End Panel Options

AUTH ¹
✓

Custom Modification Options

BAND	BND	F.ALL	F.FRT	PRO
		✓		

¹ Not available on WEP versions.

Fillers & Panels

Description	Model	Price
PILASTERS (SPECIFY STYLE and STAIN)		

PILASTERS, 5" DEEP – INSTALLATION as a DIVIDER BETWEEN CABINETS

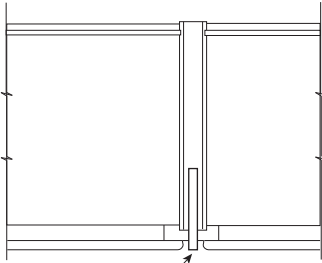

PIL530 pilaster w/TBEM

Example of 5" deep pilaster installed as a divider between cabinets

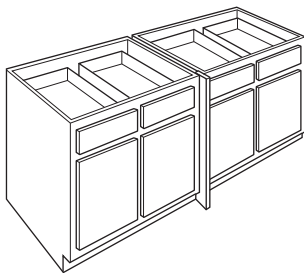

Divider between base cabinets

PIL530SBE	261
PIL530TBE	261
PIL530ROP	261
PIL530BAT	261
PIL534.5SBE	274
PIL534.5TBE	274
PIL534.5ROP	274
PIL534.5BAT	274
PIL548SBE	358
PIL548TBE	358
PIL548ROP	358
PIL548BAT	358
PIL584SBE	433
PIL584TBE	433
PIL584ROP	433
PIL584BAT	433
PIL596SBE	467
PIL596TBE	467
PIL596ROP	467
PIL596BAT	467

- Specify moulding to apply to one edge: SBE8, TBEM, RPM8, or TBATM.
- Pilasters with TBEM will be 4 13/16" deep.
- Pilasters are designed to function as dividers between cabinets and as an end of the run panel treatment. Pilasters are constructed of 3/4" thick MDF (veneered or painted) material.
- Reduced Heights available in 1/4" increments from 12" to 95 3/4".

Custom Modification Options

ID	IH ¹	RD	RH
	✓		✓

¹ Only available on 548 version.

Edging Options

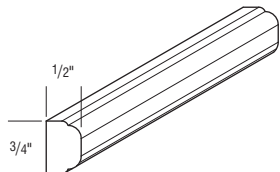

SBE8

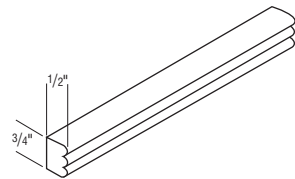

TBEM

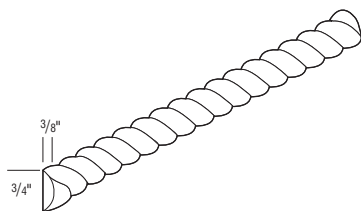

RPM8

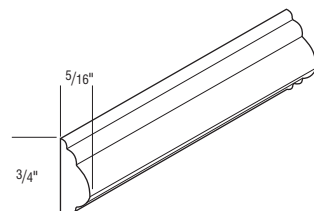

TBATM

Description	Model	Price
PILASTERS, 12 3/4" DEEP – INSTALLATION as WALL END TREATMENT		

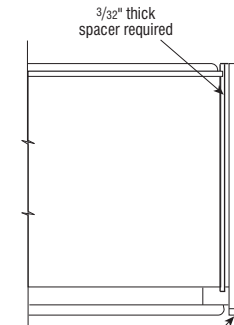

3/32" thick spacer required

PIL W30 pilaster w/TBEM

Example of 12 3/4" deep pilaster installed at the end of a run

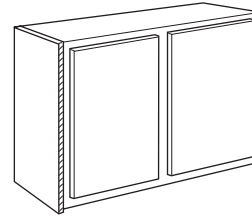

PILW30SBE	354
PILW30TBE	354
PILW30ROP	354
PILW30BAT	354
PILW34.5SBE	380
PILW34.5TBE	380
PILW34.5ROP	380
PILW34.5BAT	380
PILW48SBE	531
PILW48TBE	531
PILW48ROP	531
PILW48BAT	531
PILW84SBE	718
PILW84TBE	718
PILW84ROP	718
PILW84BAT	718
PILW96SBE	801
PILW96TBE	801
PILW96ROP	801
PILW96BAT	801

- Specify moulding to apply to one edge: SBE8, TBEM, RPM8, or TBATM.
- Pilasters with TBEM will be 12 15/16" deep.
- Pilasters are designed to function as dividers between cabinets and as an end of the run panel treatment. Pilasters are constructed of 3/4" thick MDF (veneered or painted) material.
- Inset and Beaded Inset styles are a standard 13" deep.
- Full Overlay Styles:
 - Reduced Depths available in 1/4" increments from 5 1/4" to 12 1/2".
- Inset and Beaded Inset Styles:
 - Reduced Depths available in 1/4" increments from 5 1/4" to 13 1/2".
- Reduced Heights available in 1/4" increments from 12" to 95 3/4".

Custom Modification Options

ID	IH ¹	RD	RH
	✓	✓	✓

¹ Only available on 48 version.

Edging Options

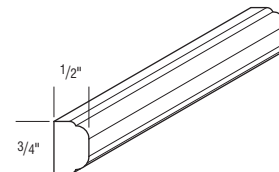

SBE8

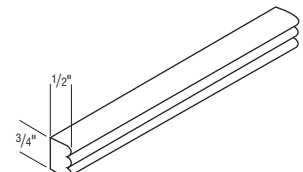

TBEM

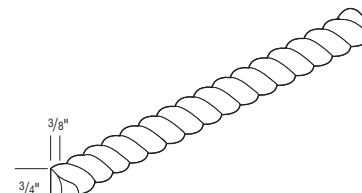

RPM8

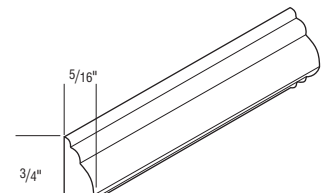

TBATM

Description

PILASTERS, 24 3/4" DEEP – INSTALLATION as BASE END TREATMENT

Model	Price
PILB30SBE	493
PILB30TBE	493
PILB30ROP	493
PILB30BAT	493
PILB34.5SBE	534
PILB34.5TBE	534
PILB34.5ROP	534
PILB34.5BAT	534
PILB48SBE	773
PILB48TBE	773
PILB48ROP	773
PILB48BAT	773
PILB84SBE	1153
PILB84TBE	1153
PILB84ROP	1153
PILB84BAT	1153
PILB96SBE	1266
PILB96TBE	1266
PILB96ROP	1266
PILB96BAT	1266

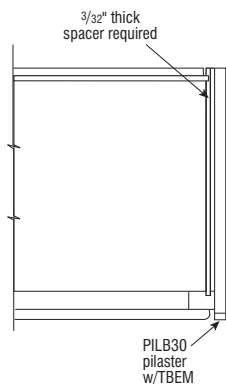

Example of 24 3/4" deep pilaster installed at the end of a run

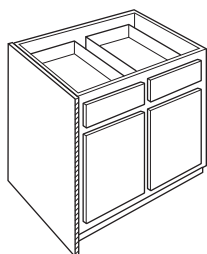

- Specify moulding to apply to one edge: SBE8, TBEM, RPM8, or TBATM.
- Pilasters with TBEM will be 24 15/16" deep.
- Pilasters are designed to function as dividers between cabinets and as an end of the run panel treatment. Pilasters are constructed of 3/4" thick MDF (veneered or painted) material.
- Reduced Heights available in 1/4" increments from 12" to 95 3/4".
- Increased Depths available in 1/4" increments from 25" to 31".
- Reduced Depths available in 1/4" increments from 13" to 24 1/2".

Custom Modification Options

ID	IH ¹	RD	RH
✓	✓	✓	✓

¹ Only available on 48 version.

Edging Options

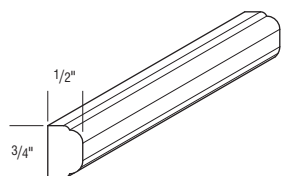

SBE8

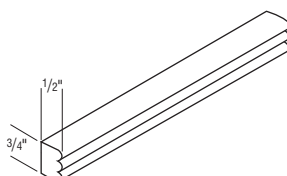

TBEM

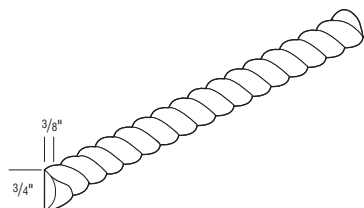

RPM8

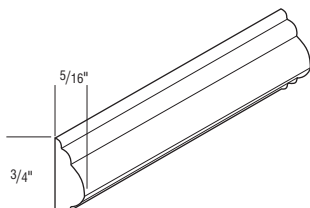

TBATM

Specialty Panels Reference Page

Title Description	Availability	Page
Wainscoting	.All Styles	Q•27
Authentic Panels	.Full Overlay	Q•28
Authentic Drawer Front Limitations		
Authentic Door Size Limitations		
Authentic Appliance Panel Ordering Information		
Authentic Panel Order Forms (www.mbc1touch.com)		
Inset Appliance Panels	.Inset & Beaded Inset	Q•30
Inset Appliance Drawer Front Limitations		
Inset Appliance Door Size Limitations		
Inset Appliance Panel Order Forms (www.mbc1touch.com)		
Integrated Panels	.Full Overlay	Q•32
Integrated Drawer Front Limitations		
Integrated Door Size Limitations		
Integrated Appliance Panel Order Form (www.mbc1touch.com)		
Overlay Panels	.Full Overlay	Q•34
Overlay Drawer Front Limitations		
Overlay Door Size Limitations		
Integrated and Overlay Appliance Panel Ordering Information		
Overlay Appliance Panel Order Form (www.mbc1touch.com)		

WAINSCOTING, 34 1/2" or 40 1/2" HIGH

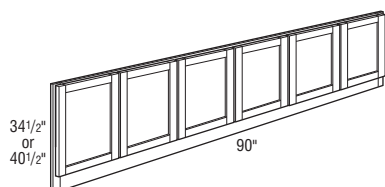
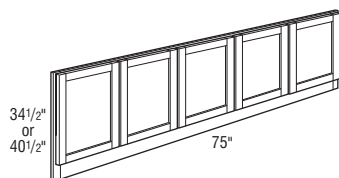
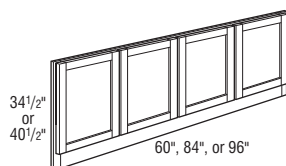
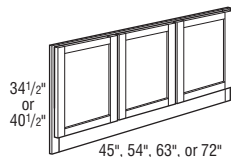
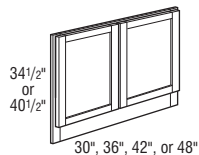
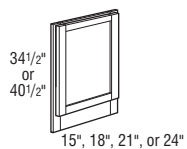

Cubic Feet	1	2	3	4	5	6	7
------------	---	---	---	---	---	---	---

GROUP A – Full Overlay Doors 14 9/16" Wide; Inset & Beaded Inset Doors 11 13/16" Wide

WAIN1534.5	1.2	642	642	642	642	642	642
WAIN3034.5	2.3	1290	1290	1290	1290	1290	1290
WAIN4534.5	3.4	1930	1930	1930	1930	1930	1930
WAIN6034.5	4.5	2577	2577	2577	2577	2577	2577
WAIN7534.5	5.6	3222	3222	3222	3222	3222	3222
WAIN9034.5	6.7	3866	3866	3866	3866	3866	3866
WAIN1540.5	1.4	760	760	760	760	760	760
WAIN3040.5	2.7	1509	1509	1509	1509	1509	1509
WAIN4540.5	4.0	2271	2271	2271	2271	2271	2271
WAIN6040.5	5.3	3027	3027	3027	3027	3027	3027
WAIN7540.5	6.5	3778	3778	3778	3778	3778	3778
WAIN9040.5	7.8	4537	4537	4537	4537	4537	4537

GROUP B – Full Overlay Doors 17 9/16" Wide; Inset & Beaded Inset Doors 14 13/16" Wide

WAIN1834.5	1.4	775	775	775	775	775	775
WAIN3634.5	2.8	1546	1546	1546	1546	1546	1546
WAIN5434.5	4.1	2319	2319	2319	2319	2319	2319
WAIN1840.5	1.7	907	907	907	907	907	907
WAIN3640.5	3.2	1815	1815	1815	1815	1815	1815
WAIN5440.5	4.7	2721	2721	2721	2721	2721	2721

GROUP C – Full Overlay Doors 20 9/16" Wide; Inset & Beaded Inset Doors 17 13/16" Wide

WAIN2134.5	1.7	903	903	903	903	903	903
WAIN4234.5	3.2	1806	1806	1806	1806	1806	1806
WAIN6334.5	4.7	2704	2704	2704	2704	2704	2704
WAIN8434.5	6.3	3601	3601	3601	3601	3601	3601
WAIN2140.5	1.9	1060	1060	1060	1060	1060	1060
WAIN4240.5	3.7	2118	2118	2118	2118	2118	2118
WAIN6340.5	5.5	3176	3176	3176	3176	3176	3176
WAIN8440.5	7.3	4232	4232	4232	4232	4232	4232

GROUP D – Full Overlay Doors 23 9/16" Wide; Inset & Beaded Inset Doors 20 13/16" Wide

WAIN2434.5	1.9	1031	1031	1031	1031	1031	1031
WAIN4834.5	3.6	2063	2063	2063	2063	2063	2063
WAIN7234.5	5.4	3094	3094	3094	3094	3094	3094
WAIN9634.5	7.1	4119	4119	4119	4119	4119	4119
WAIN2440.5	2.2	1212	1212	1212	1212	1212	1212
WAIN4840.5	4.2	2419	2419	2419	2419	2419	2419
WAIN7240.5	6.3	3630	3630	3630	3630	3630	3630
WAIN9640.5	8.3	4838	4838	4838	4838	4838	4838

- Number of doors determined by width of panel.
- Flush Toekick standard.
- Split Doors standard on all units with more than one door.
- For widths not listed above, Extended Left and/or Extended Right options are available on all sizes except 96" wide.
- Full Overlay Styles:
 - Wainscoting panel backs are not finished, but they are sealed to prevent warping and cracking.
- Inset and Beaded Inset Styles:
 - Face frame and door construction, doors applied to frame with screws.
- All doors are square.
- Increased or Reduced Heights available: 34.5"-19.5", 22.5", 25.5", 28.5", 31.5"; 40.5"-37.5", 43.5", 46.5", 49.5".

Custom Modification Options

EX	EX_OL	FLUT ¹	IH ²	RH	ROSLUT ³	WTR
✓	✓	✓	✓	✓	✓	✓

¹ Not available with fluting both or 6" fluting.

² Only available on 40.5 versions.

³ Not available with fluting both.

Authentic Panels

Authentic Panels

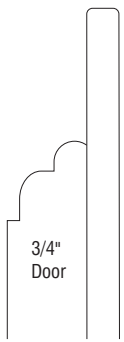

Authentic panels are used for appliance applications, backs of islands and peninsulas.

For the appliance application, the back panel will fit into the trim kit provided by the appliance manufacturer. Often called out on appliance specification sheets as framed panels. Specify the thickness and overall size of the back panel.

Complete the Appliance/Authentic Panel Specification Forms (www.mbc1touch.com).

Reference page Q•29 for additional appliance panel ordering information.

Modifications
Are Not
Available

Model

Price

DAAUTHENTIC

154

per sq ft.

Authentic Drawer Front Limitations

Slab Drawer Fronts

Available Heights: 4 1/2" – 24"; Available Widths: 7 1/2" – 47 9/16"

5-piece Drawer Fronts: (Karis and Montgomery)

Available Heights: 4 1/2" – 21 3/4"; Available Widths: 8 9/16" – 47 9/16"

5-piece Drawer Fronts: (All styles w/5-piece drawer fronts or 5-piece drawer front option (DFF5PC))

Available Heights: 5 3/4" – 21 3/4"; Available Widths: 8 9/16" – 47 9/16"

Authentic Door Size Limitations

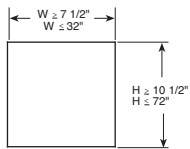

Slab Styles (Trystan)

- Minimum Width = 7 1/2"; Maximum Width = 32"
- Minimum Height = 10 1/2"; Maximum Height = 72"

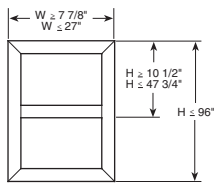

Mitered Styles (Brooks and Vesta)

- Minimum Width = 7 7/8"; Maximum Width = 27"
- Minimum Height = 10 1/2"; Maximum Height = 96"
- Arched doors are not available in mitered styles.

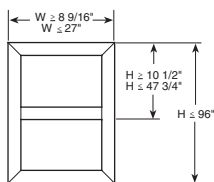

Mitered Styles with Wide Rails (Wells)

- Minimum Width = 8 9/16"; Maximum Width = 27"
- Minimum Height = 10 1/2"; Maximum Height = 96"

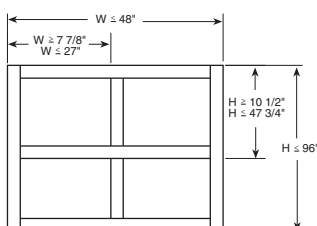

Rustic Styles with Wide Rails (Daxton, Caldera, and Summer)

- Minimum Width = 7 7/8"; Maximum Width = 48"
- Minimum Height = 10 1/2"; Maximum Height = 96"
- Heights over 47 3/4" will include two center panels, unless over 27", then they will consist of four center panels - refer to drawing chart.
- Widths up to 27" will include one center panel.
- Widths over 27" will include two center panels.

Authentic Door Size Limitations (cont'd)

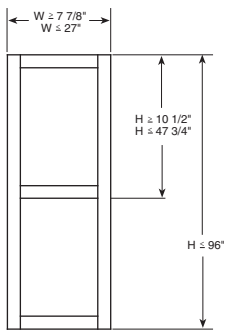

Rustic Styles (Tackett)

- Minimum Width = 7 7/8"; Maximum Width = 27"
- Minimum Height = 10 1/2"; Maximum Height = 96"
- Double wide panels not available.
- Heights over 47 3/4" will include two center panels, unless over 27", then they will consist of four center panels - refer to drawing chart.

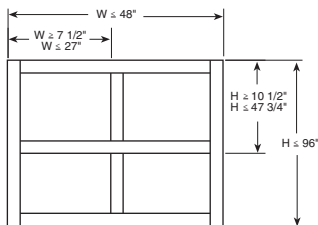

Full Overlay, Shaker, and Onlay Styles (Gunther, Karis, Langley, Montgomery, and Shona)

- Minimum Width = 7 1/2"; Maximum Width = 48"
- Minimum Height = 10 1/2"; Maximum Height = 96"
- Heights over 47 3/4" will include two center panels, unless over 27", then they will consist of four center panels - refer to drawing chart.
- Widths up to 27" will include one center panel.
- Widths over 27" will include two center panels.
- 7 1/2" wide shaped like a drawer front.
- Door side stiles in Langley may be narrower due to sizing limitations and may not match the width of side stiles within the kitchen.

Authentic Appliance Panel Ordering Information

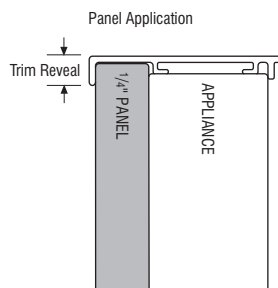

The model number from the appliance manufacturer will determine which panel type is required. Below are illustrations of authentic panels and ordering guidelines to help you place your order.

Order product 1/4VENTS for panel application.

Specify Width x Height for each panel required for appliance.

Panel is finished plywood veneer.

Edges cannot be banded or finished. Panel cut-outs not available.

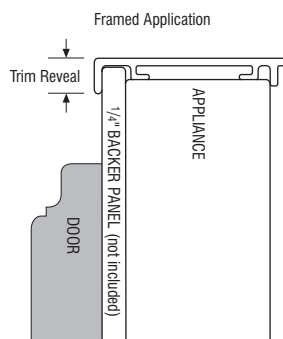

Order DAAUTHENTIC Panels for framed application.

DAAUTHENTIC is a 1/4" back panel with door applied to a panel.

Reveal is visible from front of panel.

Reference door and drawer front size limitations by style and species on pages Q•28-Q•29.

For the appliance application, the back panel will fit into the trim kit provided by the appliance manufacturer often called out on appliance specification sheets as framed panels.

1/4" back panel limitations:

48"W x 96"H (grain runs with height)

96"W x 48"H (grain runs with height)

Use the Appliance/Authentic Panel Specification Forms (www.mbc1touch.com) for ordering.

Available in 1/16" increments.

Inset Appliance Panels

Inset Appliance Panels

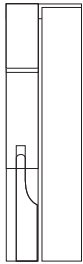

IAPPLIANCE is used for appliance applications, backs of islands and peninsulas.

Complete the Inset Appliance Panel Specification Forms (www.mbc1touch.com) and fax to Diamond Edge when placing your order.

Reference www.mbc1touch.com for additional inset appliance panel ordering information.

Model

Price

IAPPLIANCE

167

per sq ft.

Custom Modification Options

BVR	EX	FTK	WTR
✓	✓	✓	✓

Inset Appliance Drawer Front Limitations

Slab Drawer Fronts

Available Heights: 4 1/2" – 24"; Available Widths: 7 1/2" – 47 9/16"

5-piece Drawer Fronts: (Gunther, Karis, and Langley)

Available Heights: 4 1/2" – 21 3/4"; Available Widths: 8 9/16" – 47 9/16"

Inset Appliance Door Size Limitations

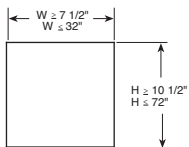

Inset and Beaded Inset Slab Styles (Trystan Beaded Inset and Trystan Inset)

- Minimum Width = 7 1/2"; Maximum Width = 32"
- Minimum Height = 10 1/2"; Maximum Height = 72"

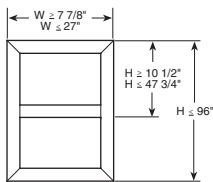

Inset and Beaded Inset Mitered Styles (Brooks Beaded Inset, Brooks Inset, Vesta Beaded Inset, and Vesta Inset)

- Minimum Width = 7 7/8"; Maximum Width = 27"
- Minimum Height = 10 1/2"; Maximum Height = 96"

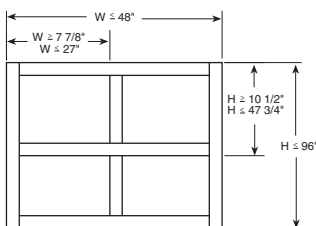

Inset and Beaded Inset Rustic Styles with Wide Rails (Brooks Beaded Inset, Brooks Inset, Daxton Beaded Inset, and Daxton Inset)

- Minimum Width = 7 7/8"; Maximum Width = 48"
- Minimum Height = 10 1/2"; Maximum Height = 96"
- Heights over 47 3/4" will include two center panels, unless over 27", then they will consist of four center panels - refer to drawing chart.
- Widths up to 27" will include one center panel.
- Widths over 27" will include two center panels.

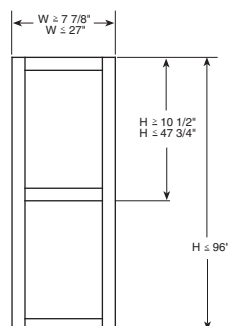

Inset and Beaded Inset Rustic Styles (Tackett Beaded Inset and Tackett Inset)

- Minimum Width = 7 7/8"; Maximum Width = 27"
- Minimum Height = 10 1/2"; Maximum Height = 96"
- Double wide panels not available.
- Heights over 47 3/4" will include two center panels, unless over 27", then they will consist of four center panels - refer to drawing chart.

Inset Appliance Door Size Limitations (cont'd)

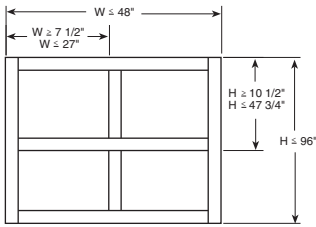

Inset and Beaded Inset Styles (Gunther Beaded Inset, Gunther Inset, Karis Beaded Inset, Karis Inset, Langley Beaded Inset, Langley Inset, Shona Beaded Inset, and Shona Inset)

- Minimum Width = 7 1/2"; Maximum Width = 48"
- Minimum Height = 10 1/2"; Maximum Height = 96"
- Heights over 47 3/4" will include two center panels, unless over 27", then they will consist of four center panels - refer to drawing chart.
- Widths up to 27" will include one center panel.
- Widths over 27" will include two center panels.
- 7 1/2" wide shaped like a drawer front.

Integrated Panels

Integrated Panels

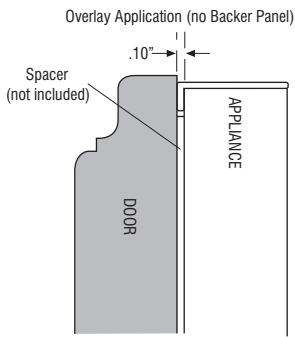

- Order product DAINTEGRATEDDR (door front)/ DAINTEGRATEDDF (drawer front) for overlay application without backer panel.
- Reference door and drawer front size limitations by style on pages Q•32-Q•33.
- Spacer panel is not available.
- If appliance specifications require sizes larger than the maximums stated (see size limitations on pages Q•32-Q•33, multiple doors will be shipped to total the overall size.
- Use the Appliance/Authentic Panel Specification Forms (www.mbcitouch.com) for ordering.
- Not available with Inset or Beaded Inset.

Model	Price	
DAINTEGRATEDDF	124	per sq ft.
DAINTEGRATEDDR	177	per sq ft.

Integrated Drawer Front Limitations

Slab Drawer Fronts

Available Heights: 4 1/2" – 24"; Available Widths: 7 1/2" – 47 9/16"

5-piece Drawer Fronts: (Karis and Montgomery)

Available Heights: 4 1/2" – 21 3/4"; Available Widths: 8 9/16" – 47 9/16"

5-piece Drawer Fronts: (All styles w/5-piece drawer fronts or 5-piece drawer front option (DFF5PC))

Available Heights: 5 3/4" – 21 3/4"; Available Widths: 8 9/16" – 47 9/16"

Integrated Door Size Limitations

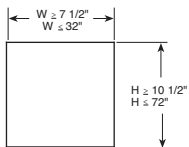

Slab Styles (Trystan)

- Minimum Width = 7 1/2"; Maximum Width = 32"
- Minimum Height = 10 1/2"; Maximum Height = 72"

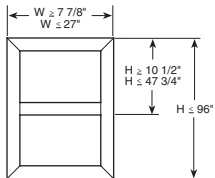

Mitered Styles (Brooks and Vesta)

- Minimum Width = 7 7/8"; Maximum Width = 27"
- Minimum Height = 10 1/2"; Maximum Height = 96"
- Arched doors are not available in mitered styles.

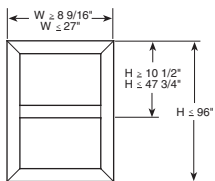

Mitered Styles with Wide Rails (Wells)

- Minimum Width = 8 9/16"; Maximum Width = 27"
- Minimum Height = 10 1/2"; Maximum Height = 96"

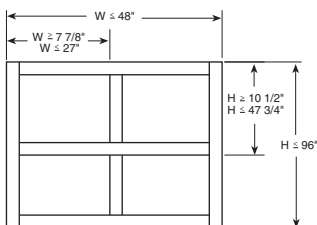

Rustic Styles with Wide Rails (Daxton, Caldera, and Summer)

- Minimum Width = 7 7/8"; Maximum Width = 48"
- Minimum Height = 10 1/2"; Maximum Height = 96"
- Heights over 47 3/4" will include two center panels, unless over 27", then they will consist of four center panels - refer to drawing chart.
- Widths up to 27" will include one center panel.
- Widths over 27" will include two center panels.

Integrated Door Size Limitations (cont'd)

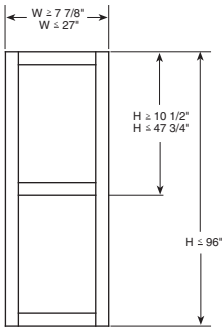

Rustic Styles (Tackett)

- Minimum Width = $7 \frac{7}{8}''$; Maximum Width = $27''$
- Minimum Height = $10 \frac{1}{2}''$; Maximum Height = $96''$
- Double wide panels not available.
- Heights over $47 \frac{3}{4}''$ will include two center panels, unless over $27''$, then they will consist of four center panels - refer to drawing chart.

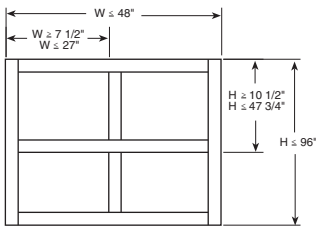

Full Overlay, Shaker, and Onlay Styles (Gunther, Karis, Langley, Montgomery, and Shona)

- Minimum Width = $7 \frac{1}{2}''$; Maximum Width = $48''$
- Minimum Height = $10 \frac{1}{2}''$; Maximum Height = $96''$
- Heights over $47 \frac{3}{4}''$ will include two center panels, unless over $27''$, then they will consist of four center panels - refer to drawing chart.
- Widths up to $27''$ will include one center panel.
- Widths over $27''$ will include two center panels.
- $7 \frac{1}{2}''$ wide shaped like a drawer front.
- Door side stiles in Langley may be narrower due to sizing limitations and may not match the width of side stiles within the kitchen.

Overlay Panels

Overlay Panels

Model

Price

DAOVERLAY

183

per sq ft.

Overlay Application (with Backer Panel)

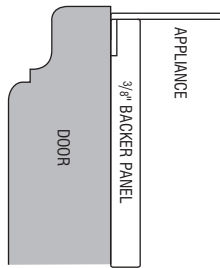

- Order product DAOVERLAY for overlay application with backer panel.
- DAOVERLAY is a 3/4" door/drawer front applied to a 3/8" backer panel rabbeted to accept a trim kit. The overlay design allows the 3/4" door/drawer front panel to cover the door trim for a more seamless appearance that blends with the design of the cabinets.
- If appliance specifications require sizes larger than the maximums stated (see size limitations on page Q•34), multiple doors will be sent to total the overall size and field work will be required to attach the doors together.
- The back of the door is unfinished, Finish All modification available when required.
- Available in 1/16" increments.

Overlay Drawer Front Limitations

Slab Drawer Fronts

Available Heights: 4 1/2" – 24"; Available Widths: 7 1/2" – 47 9/16"

5-piece Drawer Fronts: (Karis and Montgomery)

Available Heights: 4 1/2" – 21 3/4"; Available Widths: 8 9/16" – 47 9/16"

5-piece Drawer Fronts: (All styles w/5-piece drawer fronts or 5-piece drawer front option (DFF5PC))

Available Heights: 5 3/4" – 21 3/4"; Available Widths: 8 9/16" – 47 9/16"

Overlay Door Size Limitations

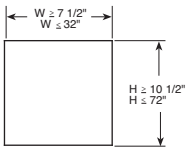

Slab Styles (Trystan)

- Minimum Width = 7 1/2"; Maximum Width = 32"
- Minimum Height = 10 1/2"; Maximum Height = 72"

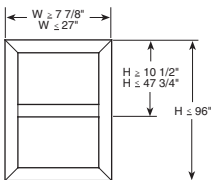

Mitered Styles (Brooks and Vesta)

- Minimum Width = 7 7/8"; Maximum Width = 27"
- Minimum Height = 10 1/2"; Maximum Height = 96"
- Arched doors are not available in mitered styles.

Integrated and Overlay Appliance Panel Ordering Information

Integrated and Overlay Appliance Panel Ordering Information

The model number from the appliance manufacturer will determine which panel type is required. Below are illustrations and ordering guidelines to help you place your order.

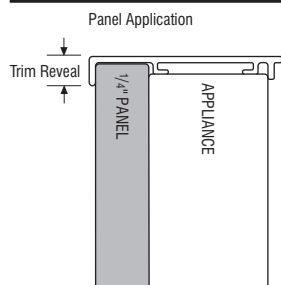

Order product 1/4VENTS for panel application.
Specify Width x Height for each panel required for appliance.
Panel is finished plywood veneer.
Edges cannot be banded or finished. Panel cut-outs not available.

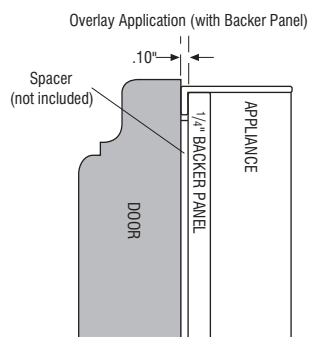

Order products 1/4VENTS and DAINTEGRATEDDR (door front)/DAINTEGRATEDDF (drawer front) for overlay application with backer panel.
Doors and panels shipped unassembled.
Spacer panel is not available.
Specify Width x Height for each backer panel required for appliance.
Order DAINTEGRATEDDR (door front)/DAINTEGRATEDDF (drawer front) required, reference door and drawer front size limitations by style and species on pages Q•32-Q•33.
Use the Appliance Panel Specification Form (www.mbc1touch.com) for ordering.

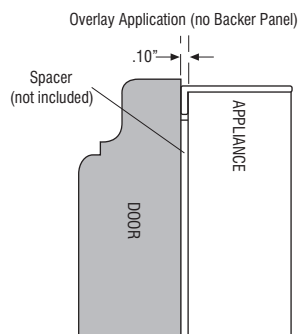

Order products DAINTEGRATEDDR (door front)/DAINTEGRATEDDF (drawer front) for overlay application without backer panel.
Specify Width x Height for each door and/or drawer required for appliance.
Reference door and drawer front size limitations by style and species on pages Q•32-Q•33.
Spacer panel is not available.
Use the Appliance Panel Specification Form (www.mbc1touch.com) for ordering.

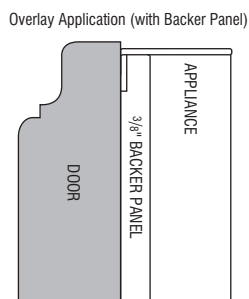

Order product DAOVERLAY for overlay application with backer panel.
Specify Width x Height for each door and/or drawer required for appliance.
Reference door and drawer front size limitations by style and species on page Q•34.
Use the Appliance Panel Specification Form (www.mbc1touch.com) for ordering.

Notes

Diamond Edge Modification Option Descriptions

Your Diamond Edge price guide contains charts with modification option codes for each applicable cabinetry product. Reference the listing below to identify the modification description.

Custom Modification Options	
Option	Description
F.ALL	Finished All
ID	Increased Depth
IH	Increased Height
IW	Increased Width
RD	Reduced Depth
RH	Reduced Height
RW	Reduced Width

Mouldings & Embellishments

Description	Model	Price
MOULDINGS		

SOFFIT FILLER MOULDING

SFM8	543
SFM10	675

- SFM8: 2 1/2" x 6" x 96".
- SFM10: 2 1/2" x 6" x 120".
- Alder will be used for Rustic Alder.
- Walnut not available on SFM10.
- Glazes and/or Techniques available: F, P, TW, XTW, HW, XHW.

Custom Modification Options

F.ALL ¹
<input checked="" type="checkbox"/>

¹ Only available on 10'.

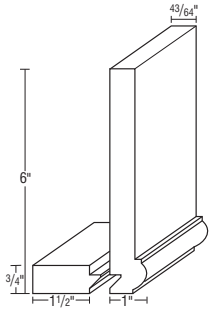

STARTER MOULDING

STR8	465
STR10	582

- STR8: 1 3/4" x 3" x 96".
- STR10: 1 3/4" x 3" x 120".
- Alder will be used for Rustic Alder.
- Walnut not available on STR10.
- Glazes and/or Techniques available: F, P, TW, XTW, HW, XHW.

Custom Modification Options

F.ALL ¹
<input checked="" type="checkbox"/>

¹ Only available on 10'.

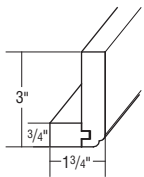

STARTER SHAKER MOULDING

STRS8	304
STRS10	411

- STRS8: 1 3/4" x 3" x 96".
- STRS10: 1 3/4" x 3" x 120".
- Not available in Alder, Rustic Alder, or Walnut.
- Glazes and/or Techniques available: F, P, TW, XTW, HW, XHW.

Custom Modification Options

F.ALL ¹
<input checked="" type="checkbox"/>

¹ Only available on 10'.

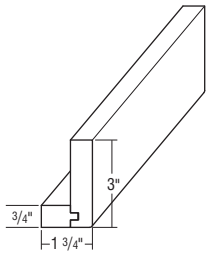

CLASSIC TALL CROWN MOULDING

CLTCROWN	475
CLTCROWN10	594

- CLTCROWN: 5 1/4" x 4 3/32" x 96".
- CLTCROWN10: 5 1/4" x 4 3/32" x 120".
- Ships in two pieces.
- Not available in Walnut.
- Glazes and/or Techniques available: F, P, TW, XTW, HW, XHW.

Custom Modification Options

F.ALL ¹
<input checked="" type="checkbox"/>

¹ Only available on 10'.

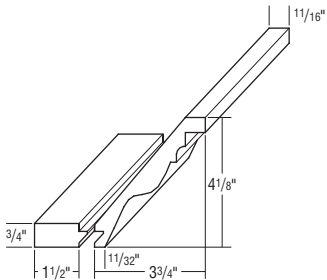

8' mouldings will have 93"-99" of useable length.
10' mouldings will have 117"-123" useable length.

Glazes and Techniques

F = Flooded (see page E•4.)
P = Penned (see page E•4.)
TW = Timeworn (see page E•4.)
XTW = Extra Timeworn (see page E•4.)
HW = Hewn (see page E•4.)
XHW = Extra Hewn (see page E•4.)

Description	Model	Price
CORNICE TALL CROWN MOULDING		
COTCROWN	475	
COTCROWN10	594	

- COTCROWN: 5 5/16" x 4 1/32" x 96".
- COTCROWN10: 5 5/16" x 4 1/32" x 120".
- Ships in two pieces.
- Not available in Walnut.
- Glazes and/or Techniques available: F, P, TW, XTW, HW, XHW.

Custom Modification Options

F.ALL ¹
<input checked="" type="checkbox"/>

¹ Only available on 10'.

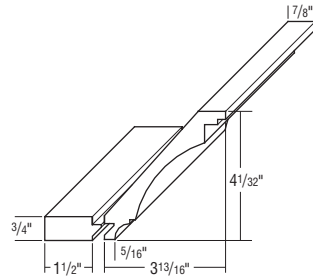

COVE CROWN MOULDING

COVECROWN	475
COVECROWN10	594

- COVECROWN: 5" x 3 25/32" x 96".
- COVECROWN10: 5" x 3 25/32" x 120".
- Ships in two pieces.
- Walnut not available on COVECROWN10.
- Glazes and/or Techniques available: F, TW, XTW, HW, XHW.

Custom Modification Options

F.ALL ¹
<input checked="" type="checkbox"/>

¹ Only available on 10'.

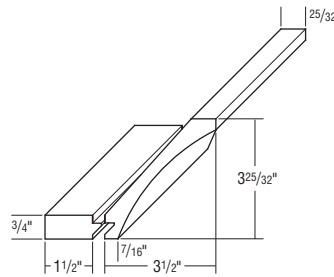

SMALL COVE CROWN MOULDING

SMCOVECROWN	320
SMCOVECROWN10	399

- SMCOVECROWN: 2 5/16" x 2 1/2" x 96".
- SMCOVECROWN10: 2 5/16" x 2 1/2" x 120".
- Walnut not available on SMCOVECROWN10.
- Glazes and/or Techniques available: F, TW, XTW, HW, XHW.

Custom Modification Options

F.ALL ¹
<input checked="" type="checkbox"/>

¹ Only available on 10'.

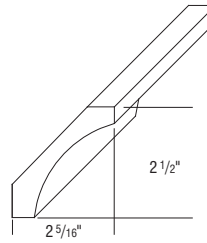

SIMPLICITY CROWN

SIMCROWN	661
-----------------	-----

- 3 29/32" x 27/32" x 96".
- Alder will be used for Rustic Alder.
- Not available in Quartersawn Oak or Walnut.

Custom Modification Options

F.ALL
<input checked="" type="checkbox"/>

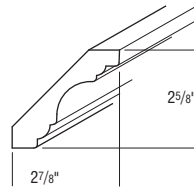

CROWN MOULDING

SWCRM8	234
SWCRM10	292

- SWCRM8: 1 5/8" x 1 5/8" x 96".
- SWCRM10: 1 5/8" x 1 5/8" x 120".
- Walnut not available on SWCRM10.
- Glazes and/or Techniques available: F, P, TW, XTW, HW, XHW.

Custom Modification Options

F.ALL ¹
<input checked="" type="checkbox"/>

¹ Only available on 10'.

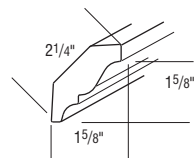

Description	Model	Price
LARGE STRAIGHT ANGLE CROWN MOULDING	LSACROWN8	314
	LSACROWN10	423

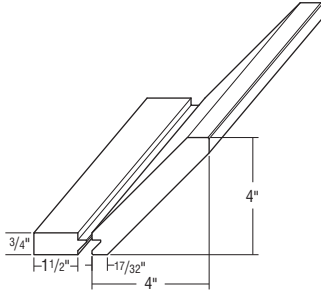

- LSACROWN8: 5 1/2" x 4" x 96".
- LSACROWN10: 5 1/2" x 4" x 120".
- Ships in two pieces.
- Includes Soffit Filler Moulding Cleat.
- Not available in Alder or Rustic Alder.
- Glazes and/or Techniques available: F, TW, XTW, HW, XHW.

Custom Modification Options

FALL ¹	<input checked="" type="checkbox"/>
-------------------	-------------------------------------

¹ Only available on 10'.

MEDIUM STRAIGHT ANGLE CROWN MOULDING	MSACROWN8	310
	MSACROWN10	418

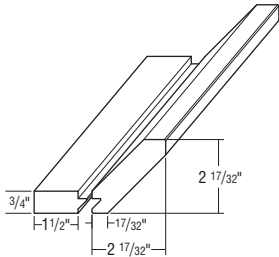

- MSACROWN8: 4 1/32" x 2 17/32" x 96".
- MSACROWN10: 4 1/32" x 2 17/32" x 120".
- Ships in two pieces.
- For use with mouldings specified in this section.
- Includes Soffit Filler Moulding Cleat.
- Not available in Alder or Rustic Alder.
- Glazes and/or Techniques available: F, TW, XTW, HW, XHW.

Custom Modification Options

FALL ¹	<input checked="" type="checkbox"/>
-------------------	-------------------------------------

¹ Only available on 10'.

STRAIGHT ANGLE CROWN MOULDING	SACROWN8	260
	SACROWN10	351

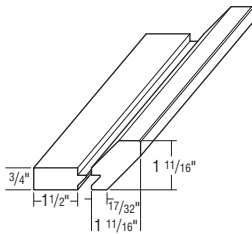

- SACROWN8: 3 3/16" x 1 11/16" x 96".
- SACROWN10: 3 3/16" x 1 11/16" x 120".
- Ships in two pieces.
- For use with mouldings specified in this section.
- Includes Soffit Filler Moulding Cleat.
- Not available in Alder or Rustic Alder.
- Glazes and/or Techniques available: F, TW, XTW, HW, XHW.

Custom Modification Options

FALL ¹	<input checked="" type="checkbox"/>
-------------------	-------------------------------------

¹ Only available on 10'.

LARGE SHAKER CROWN MOULDING	LSHAKER8	207
	LSHAKER10	280

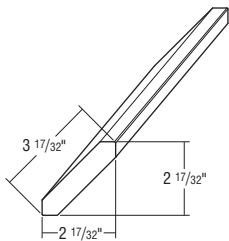

- LSHAKER8: 2 17/32" x 2 17/32" x 96".
- LSHAKER10: 2 17/32" x 2 17/32" x 120".
- For use with mouldings specified in this section.
- Not available in Alder or Rustic Alder.
- Glazes and/or Techniques available: F, TW, XTW, HW, XHW.

Custom Modification Options

FALL ¹	<input checked="" type="checkbox"/>
-------------------	-------------------------------------

¹ Only available on 10'.

FULL OVERLAY CROWN MOULDING	FOLCROWN	267
	FOLCROWN10	335

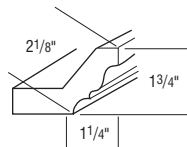

- FOLCROWN: 1 1/4" x 2 1/8" x 96".
- FOLCROWN10: 1 1/4" x 2 1/8" x 120".
- Not available in Walnut.
- Glazes and/or Techniques available: F, P, TW, XTW, HW, XHW.

Custom Modification Options

FALL ¹	<input checked="" type="checkbox"/>
-------------------	-------------------------------------

¹ Only available on 10'.

Description	Model	Price
INSERT CROWN MOULDING	SWVCRM8	400
	SWVCRM10	501

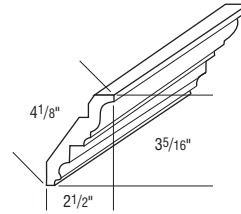

- SWVCRM8: 2 1/2" x 3 5/16" x 96".
- SWVCRM10: 2 1/2" x 3 5/16" x 120".
- Walnut not available on SWVCRM10.
- Glazes and/or Techniques available: F, P, TW, XTW, HW, XHW.

Custom Modification Options

FALL ¹	<input checked="" type="checkbox"/>
-------------------	-------------------------------------

¹ Only available on 10'.

LARGE CROWN MOULDING	SWLCRM8	320
	SWLCRM10	399

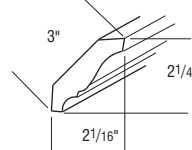

- SWLCRM8: 2 1/16" x 2 1/4" x 96".
- SWLCRM10: 2 1/16" x 2 1/4" x 120".
- Walnut not available on SWLCRM10.
- Glazes and/or Techniques available: F, P, TW, XTW, HW, XHW.

Custom Modification Options

FALL ¹	<input checked="" type="checkbox"/>
-------------------	-------------------------------------

¹ Only available on 10'.

LARGE INSERT CROWN	LRCROWN	619
---------------------------	----------------	-----

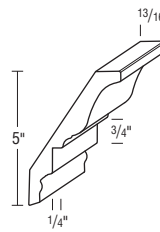

- 13/16" x 5" x 96".
- For use with Light Rail Mouldings specified in Inserts section.
- Oak will be used for Quartersawn Oak.
- Not available in Walnut.
- Glazes and/or Techniques available: F, P, TW, XTW, HW, XHW.

Custom Modification Options

FALL	<input checked="" type="checkbox"/>
------	-------------------------------------

SHAKER CROWN MOULDING	SHKCRM8	324
	SHKCRM10	406

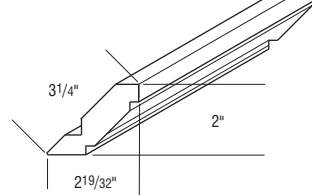

- SHKCRM8: 2 19/32" x 2" x 96".
- SHKCRM10: 2 19/32" x 2" x 120".
- Not available in Walnut.
- Glazes and/or Techniques available: F, P, TW, XTW, HW, XHW.

Custom Modification Options

FALL ¹	<input checked="" type="checkbox"/>
-------------------	-------------------------------------

¹ Only available on 10'.

8' mouldings will have 93"-99" of useable length.
10' mouldings will have 117"-123" useable length.

Glazes and Techniques

F = Flooded (see page E•4.)
P = Penned (see page E•4.)
TW = Timeworn (see page E•4.)
XTW = Extra Timeworn (see page E•4.)
HW = Hewn (see page E•4.)
XHW = Extra Hewn (see page E•4.)

Mouldings & Embellishments

Description	Model	Price
SOFFIT SCRIBE CROWN MOULDING	SCM8	208
	SCM10	261

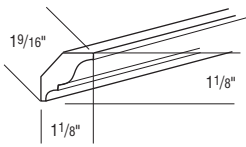

- SCM8: 1 1/8" x 1 1/8" x 96"
- SCM10: 1 1/8" x 1 1/8" x 120"
- Not available in Walnut.
- Glazes and/or Techniques available: F, P, TW, XTW, HW, XHW.

Custom Modification Options

FALL ¹	<input checked="" type="checkbox"/>
-------------------	-------------------------------------

¹ Only available on 10'.

TALL CROWN MOULDING	MTCROWN8	376
	TCROWN10	470

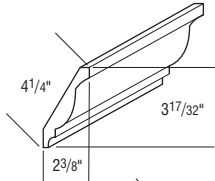

- MTCROWN8: 2 3/8" x 3 17/32" x 96"
- TCROWN10: 2 3/8" x 3 17/32" x 120"
- Walnut not available on TCROWN10.
- Glazes and/or Techniques available: F, P, TW, XTW, HW, XHW.

Custom Modification Options

FALL ¹	<input checked="" type="checkbox"/>
-------------------	-------------------------------------

¹ Only available on 10'.

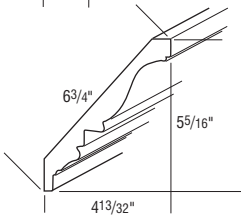

TLCROWN	456
TLCROWN10	570

- TLCROWN: 4 13/32" x 5 5/16" x 96"
- TLCROWN10: 4 13/32" x 5 5/16" x 120"
- Not available in Walnut.
- Glazes and/or Techniques available: F, P, TW, XTW, HW, XHW.

Custom Modification Options

FALL ¹	<input checked="" type="checkbox"/>
-------------------	-------------------------------------

¹ Only available on 10'.

SOLID WOOD TALL CROWN MOULDING	SWTCRM8	240
	SWTCRM10	324

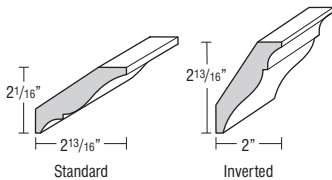

- SWTCRM8: 2 13/16" x 2 1/16" x 96"
- SWTCRM10: 2 13/16" x 2 1/16" x 120"
- Not available in Walnut.
- SWTCRM10 only available in Cherry and Maple.
- Glazes and/or Techniques available: F, P, TW, XTW, HW, XHW.

Custom Modification Options

FALL	<input checked="" type="checkbox"/>
------	-------------------------------------

8" mouldings will have 93"-99" of useable length.
10" mouldings will have 117"-123" useable length.

Glazes and Techniques

- F** = Flooded (see page E-4.)
- P** = Penned (see page E-4.)
- TW** = Timeworn (see page E-4.)
- XTW** = Extra Timeworn (see page E-4.)
- HW** = Hewn (see page E-4.)
- XHW** = Extra Hewn (see page E-4.)

Description	Model	Price
INSERT PANEL CROWN	INSCROWN	433

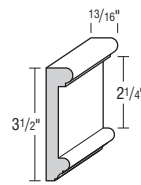

- 13/16" x 3 1/2" x 96"
- For use with mouldings specified in this section.
- Alder will be used for Rustic Alder.
- Oak will be used for Quartersawn Oak.
- Not available in Walnut.
- Abbey Column Inserts available. See page R-49.
- Glazes and/or Techniques available: F, P.

Custom Modification Options

FALL	<input checked="" type="checkbox"/>
------	-------------------------------------

CREATE-A-CROWN INSERT	INSERTFRM	465
------------------------------	------------------	-----

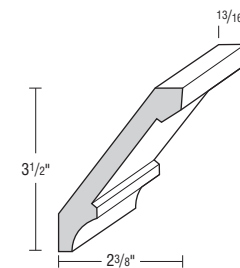

- 13/16" x 3 1/2" x 96"
- For use with mouldings specified in this section.
- Alder will be used for Rustic Alder.
- Oak will be used for Quartersawn Oak.
- Not available in Walnut.
- Abbey Column Inserts available. See page R-49.
- Glazes and/or Techniques available: F, P.

Custom Modification Options

FALL	<input checked="" type="checkbox"/>
------	-------------------------------------

TRIM MOULDING	TM	139
	TM10	172

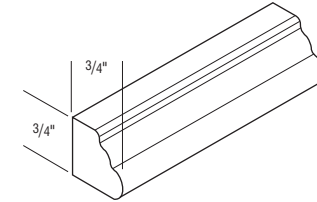

- TM: 3/4" x 3/4" x 96"
- TM10: 3/4" x 3/4" x 120"
- Alder will be used for Rustic Alder.
- Not available in Walnut.
- Glazes and/or Techniques available: F, P, TW, XTW, HW, XHW.

Custom Modification Options

FALL ¹	<input checked="" type="checkbox"/>
-------------------	-------------------------------------

¹ Only available on 10'.

CAP MOULDING	CAPM	154
	CAPM10	194

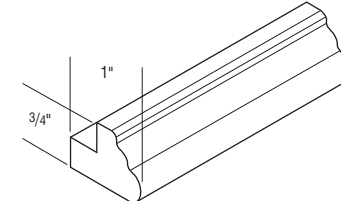

- CAPM: 3/4" x 1" x 96"
- CAPM10: 3/4" x 1" x 120"
- Alder will be used for Rustic Alder.
- Not available in Walnut.
- Glazes and/or Techniques available: F, P, TW, XTW, HW, XHW.

Custom Modification Options

FALL ¹	<input checked="" type="checkbox"/>
-------------------	-------------------------------------

¹ Only available on 10'.

TRADITIONAL SOFFIT TRIM MOULDING	TSTM	235
	TSTM10	293

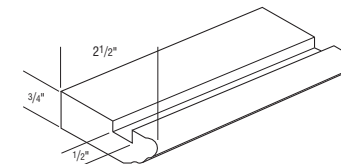

- TSTM: 3/4" x 2 1/2" x 96"
- TSTM10: 3/4" x 2 1/2" x 120"
- Alder will be used for Rustic Alder.
- 1/2" wide groove.
- Not available in Walnut.
- TSTM10 is not available in Quartersawn Oak.
- Glazes and/or Techniques available: F, P, TW, XTW, HW, XHW.

Custom Modification Options

FALL ¹	<input checked="" type="checkbox"/>
-------------------	-------------------------------------

¹ Only available on 10'.

Mouldings & Embellishments

Description	Model	Price
SOFFIT TRIM MOULDING	STM8	207
	STM10	280

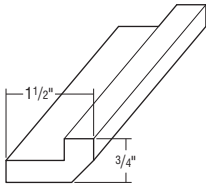

- STM8: 1 1/2" x 3/4" x 96"
- STM10: 1 1/2" x 3/4" x 120"
- 1/2" wide groove.
- Not available in Alder or Rustic Alder.
- Glazes and/or Techniques available: F, P, TW, XTW, HW, XHW.

Custom Modification Options

F.ALL ¹	<input checked="" type="checkbox"/>
--------------------	-------------------------------------

¹ Only available on 10'.

ANGLED SOFFIT TRIM MOULDING ASTM	ASTM8	207
	ASTM10	280

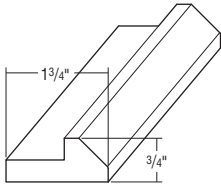

- ASTM8: 1 3/4" x 3/4" x 96"
- ASTM10: 1 3/4" x 3/4" x 120"
- 1/2" wide groove.
- Not available in Alder or Rustic Alder.
- Glazes and/or Techniques available: F, P, TW, XTW, HW, XHW.

Custom Modification Options

F.ALL ¹	<input checked="" type="checkbox"/>
--------------------	-------------------------------------

¹ Only available on 10'.

LIGHT RAIL MOULDING	LRM	545
	LRM10	682

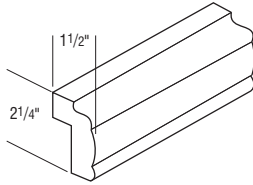

- LRM: 1 1/2" x 2 1/4" x 96"
- LRM10: 1 1/2" x 2 1/4" x 120"
- Alder will be used for Rustic Alder.
- Not available in Walnut.
- Glazes and/or Techniques available: F, P, TW, XTW.

Custom Modification Options

F.ALL ¹	<input checked="" type="checkbox"/>
--------------------	-------------------------------------

¹ Only available on 10'.

TRADITIONAL LIGHT RAIL	TLR8	320
	TLR10	399

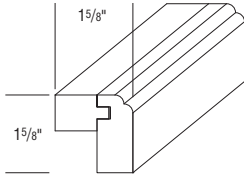

- TLR8: 1 5/8" x 1 5/8" x 96"
- TLR10: 1 5/8" x 1 5/8" x 120"
- Alder will be used for Rustic Alder.
- Not available in Walnut.
- Glazes and/or Techniques available: F, P, TW, XTW, HW, XHW.

Custom Modification Options

F.ALL ¹	<input checked="" type="checkbox"/>
--------------------	-------------------------------------

¹ Only available on 10'.

CONCAVE LIGHT RAIL MOULDING	CNVLRAIL8	282
	CNVLRAIL10	380

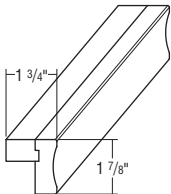

- CNVLRAIL8: 1 3/4" x 1 7/8" x 96"
- CNVLRAIL10: 1 3/4" x 1 7/8" x 120"
- Not available in Alder or Rustic Alder.
- Glazes and/or Techniques available: F, P, TW, XTW, HW, XHW.

Custom Modification Options

F.ALL ¹	<input checked="" type="checkbox"/>
--------------------	-------------------------------------

¹ Only available on 10'.

Description	Model	Price
SMALL LIGHT RAIL MOULDING	SMLR	444
	SMLR10	556

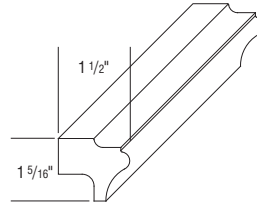

- SMLR: 1 1/2" x 1 5/16" x 96"
- SMLR10: 1 1/2" x 1 5/16" x 120"
- Alder will be used for Rustic Alder.
- Walnut not available on SMLR10.
- Glazes and/or Techniques available: F, P, TW, XTW, HW, XHW.

Custom Modification Options

F.ALL ¹	<input checked="" type="checkbox"/>
--------------------	-------------------------------------

¹ Only available on 10'.

TRADITIONAL LIGHT RAIL MOULDING	JINSERTLRT	759
--	-------------------	-----

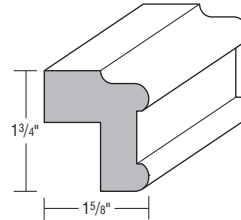

- 1 5/8" x 1 3/4" x 96"
- For use with Light Rail Mouldings specified in this section.
- Oak will be used for Quartersawn Oak.
- Not available in Walnut.
- Glazes and/or Techniques available: F, P, TW, XTW, HW, XHW.

Custom Modification Options

F.ALL	<input checked="" type="checkbox"/>
-------	-------------------------------------

CONTEMPORARY LIGHT RAIL MOULDING	JINSERTLRC	727
---	-------------------	-----

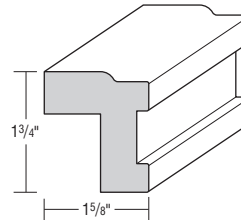

- 1 5/8" x 1 3/4" x 96"
- For use with Light Rail Mouldings specified in this section.
- Alder will be used for Rustic Alder.
- Oak will be used for Quartersawn Oak.
- Not available in Walnut.
- Glazes and/or Techniques available: F, P, TW, XTW, HW, XHW.

Custom Modification Options

F.ALL	<input checked="" type="checkbox"/>
-------	-------------------------------------

VALLEY FORGE MOULDING	VFR8	95
------------------------------	-------------	----

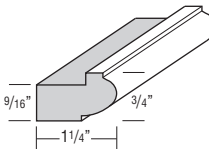

- VFR8: 1 1/4" x 3/4" x 96"
- Alder will be used for Rustic Alder.
- Not available in Walnut.
- Glazes and/or Techniques available: F, P, TW, XTW, HW, XHW.

Custom Modification Options

F.ALL	<input checked="" type="checkbox"/>
-------	-------------------------------------

LIGHT BAFFLE	LB2	153
---------------------	------------	-----

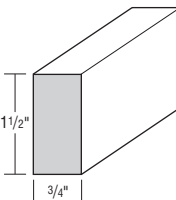

- LB2: 3/4" x 1 1/2" x 96"
- Alder will be used for Rustic Alder.
- Glazes and/or Techniques available: F, TW, XTW, HW, XHW.

Custom Modification Options

F.ALL	<input checked="" type="checkbox"/>
-------	-------------------------------------

8' mouldings will have 93"-99" of useable length.
10' mouldings will have 117"-123" useable length.

Glazes and Techniques

- F = Flooded (see page E•4.)
- P = Penned (see page E•4.)
- TW = Timeworn (see page E•4.)
- XTW = Extra Timeworn (see page E•4.)
- HW = Hewn (see page E•4.)
- XHW = Extra Hewn (see page E•4.)

Mouldings & Embellishments

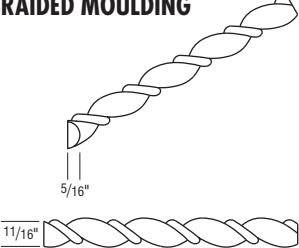
Description	Model	Price		
BRAIDED MOULDING	BRAIDM	173		
	<ul style="list-style-type: none"> • 1 1/16" x 5/16" x 96". • Alder will be used for Rustic Alder. • Not available in Walnut. • Glazes and/or Techniques available: F, P. 	<p>Custom Modification Options</p> <table border="1"> <tr> <td>F.A.L.L.</td> </tr> <tr> <td>✓</td> </tr> </table>	F.A.L.L.	✓
F.A.L.L.				
✓				

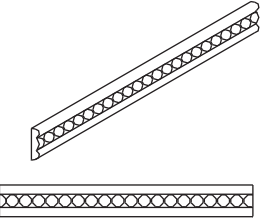
CENTER BEADED MOULDING	CBEADM	173	
	CBEADM10	215	
	<ul style="list-style-type: none"> • CBEADM: 3/4" x 9/32" x 96". • CBEADM10: 3/4" x 9/32" x 120". • Alder will be used for Rustic Alder. • Not available in Walnut. • Glazes and/or Techniques available: F, P. 	<p>Custom Modification Options</p> <table border="1"> <tr> <td>F.A.L.L.¹</td> </tr> <tr> <td>✓</td> </tr> </table> <p>¹ Only available on 10'.</p>	F.A.L.L. ¹
F.A.L.L. ¹			
✓			

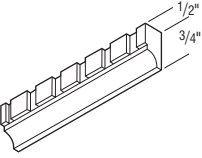
DENTIL MOULDING	MDENTIL8	271
	<ul style="list-style-type: none"> • 1/2" x 3/4" x 96". • Alder will be used for Rustic Alder. • Not available in Walnut. • Glazes and/or Techniques available: F, P. 	<p>Modifications Are Not Available</p>

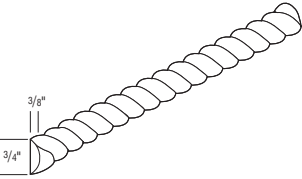
ROPE MOULDING	RPM8	140		
	<ul style="list-style-type: none"> • 3/8" x 3/4" x 96". • Can be used as an insert for insert crown moulding. • Alder will be used for Rustic Alder. • Not available in Walnut. • Glazes and/or Techniques available: F, P, HW, XHW. 	<p>Custom Modification Options</p> <table border="1"> <tr> <td>F.A.L.L.</td> </tr> <tr> <td>✓</td> </tr> </table>	F.A.L.L.	✓
F.A.L.L.				
✓				

8' mouldings will have 93"-99" of useable length.
10' mouldings will have 117"-123" useable length.

Glazes and Techniques
F = Flooded (see page E•4.)
P = Penned (see page E•4.)
TW = Timeworn (see page E•4.)
XTW = Extra Timeworn (see page E•4.)
HW = Hewn (see page E•4.)
XHW = Extra Hewn (see page E•4.)

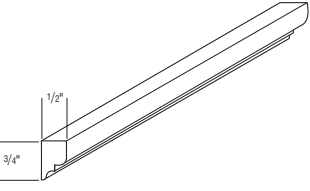
Description	Model	Price	
OGEE MOULDING	OGEEM	129	
	OGEEM10	162	
	<ul style="list-style-type: none"> • OGEEM: 1/2" x 3/4" x 96". • OGEEM10: 1/2" x 3/4" x 120". • Can be used as an insert for insert crown moulding. • Alder will be used for Rustic Alder. • Not available in Walnut. • OGEEM10 is not available in Quartersawn Oak. • Glazes and/or Techniques available: F, P, TW, XTW, HW, XHW. 	<p>Custom Modification Options</p> <table border="1"> <tr> <td>F.A.L.L.¹</td> </tr> <tr> <td>✓</td> </tr> </table> <p>¹ Only available on 10'.</p>	F.A.L.L. ¹
F.A.L.L. ¹			
✓			

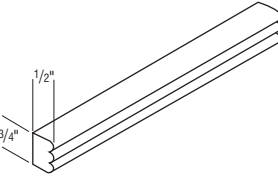
TRIPLE BEAD MOULDING	TBEM	129	
	TBEM10	162	
	<ul style="list-style-type: none"> • TBEM: 1/2" x 3/4" x 96". • TBEM10: 1/2" x 3/4" x 120". • Can be used as an insert for insert crown moulding. • Alder will be used for Rustic Alder. • Not available in Walnut. • Glazes and/or Techniques available: F, P, TW, XTW, HW, XHW. 	<p>Custom Modification Options</p> <table border="1"> <tr> <td>F.A.L.L.¹</td> </tr> <tr> <td>✓</td> </tr> </table> <p>¹ Only available on 10'.</p>	F.A.L.L. ¹
F.A.L.L. ¹			
✓			

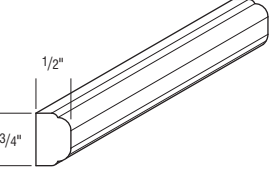
SINGLE BEAD EDGE	SBE8	129	
	SBE10	162	
	<ul style="list-style-type: none"> • SBE8: 3/4" x 1/2" x 96". • SBE10: 3/4" x 1/2" x 120". • Alder will be used for Rustic Alder. • Not available in Walnut. • Glazes and/or Techniques available: F, P, TW, XTW. 	<p>Custom Modification Options</p> <table border="1"> <tr> <td>F.A.L.L.¹</td> </tr> <tr> <td>✓</td> </tr> </table> <p>¹ Only available on 10'.</p>	F.A.L.L. ¹
F.A.L.L. ¹			
✓			

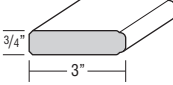
SINGLE BEAD MOULDING	SBM8	252		
	<ul style="list-style-type: none"> • SBM8: 3" x 3/4" x 96". • Alder will be used for Rustic Alder. • Not available in Walnut. • Glazes and/or Techniques available: F, P, TW, XTW, HW, XHW. 	<p>Custom Modification Options</p> <table border="1"> <tr> <td>F.A.L.L.</td> </tr> <tr> <td>✓</td> </tr> </table>	F.A.L.L.	✓
F.A.L.L.				
✓				

Mouldings & Embellishments

Description	Model	Price		
ABBAY CROWN INSERT	ABBEYNSWI	593		
<ul style="list-style-type: none"> Wrought Iron 2 1/4" x 1/8" x 96". 32" repeat. Must be used as an insert for Insert Panel Crown (INSCROWN) or Create-A-Crown (INSERTFRM). 				
<p>Custom Modification Options</p> <table border="1"> <tr> <td>F.ALL</td> <td>✓</td> </tr> </table>			F.ALL	✓
F.ALL	✓			

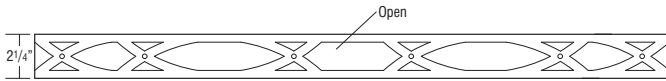

Description	Model	Price		
ABBAY LIGHT RAIL INSERT	ABBEYNSSWI	565		
<ul style="list-style-type: none"> Wrought Iron 3/4" x 1/8" x 96". 8" repeat. Must be used as an insert for Traditional Light Rail Moulding (JINSERTLRT) or Contemporary Light Rail Moulding (JINSERTLRC). 				
<p>Custom Modification Options</p> <table border="1"> <tr> <td>F.ALL</td> <td>✓</td> </tr> </table>			F.ALL	✓
F.ALL	✓			



Description	Model	Price		
ROUND COUNTERTOP MOULDING	RCTM	154		
	RCTM10	194		
<ul style="list-style-type: none"> RCTM: 3/4" x 1 1/2" x 96". RCTM10: 3/4" x 1 1/2" x 120". Alder will be used for Rustic Alder. Not available in Walnut. Glazes and/or Techniques available: F, TW, XTW. 				
<p>Custom Modification Options</p> <table border="1"> <tr> <td>F.ALL¹</td> <td>✓</td> </tr> </table> <p>¹ Only available on 10'.</p>			F.ALL ¹	✓
F.ALL ¹	✓			

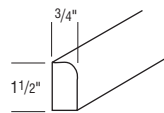

Description	Model	Price		
BEVELED EDGE MOULDING	TCM8	123		
	TCM10	154		
<ul style="list-style-type: none"> TCM8: 3/4" x 1 1/2" x 96". TCM10: 3/4" x 1 1/2" x 120". Alder will be used for Rustic Alder. Not available in Walnut. Glazes and/or Techniques available: F, TW, XTW, HW, XHW. 				
<p>Custom Modification Options</p> <table border="1"> <tr> <td>F.ALL¹</td> <td>✓</td> </tr> </table> <p>¹ Only available on 10'.</p>			F.ALL ¹	✓
F.ALL ¹	✓			

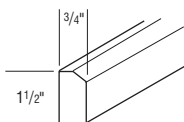

Description	Model	Price
PROFILE EDGE MOULDING	SHAPE10	169
	SHAPE12	169
	SHAPE14	169
	SHAPE15	169
	SHAPE17	169
	SHAPE27	169
<ul style="list-style-type: none"> Countertop Moulding 3/4" x 1 1/2" x 96". Alder will be used for Rustic Alder. Glazes and/or Techniques available: F, TW, XTW, HW, XHW. 		

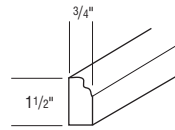

Shape 14 Shown

Modifications Are Not Available

Description	Model	Price		
SMALL SCRIBE MOULDING	SSM	46		
	SSM10	58		
<ul style="list-style-type: none"> SSM: 1/4" x 3/4" x 96". SSM10: 1/4" x 3/4" x 120". Alder will be used for Rustic Alder. Glazes and/or Techniques available: F, TW, XTW. 				
<p>Custom Modification Options</p> <table border="1"> <tr> <td>F.ALL¹</td> <td>✓</td> </tr> </table> <p>¹ Only available on 10'.</p>			F.ALL ¹	✓
F.ALL ¹	✓			



Description	Model	Price		
LARGE SCRIBE MOULDING	LSM	171		
<ul style="list-style-type: none"> 3/4" x 2" x 96". Alder will be used for Rustic Alder. Glazes and/or Techniques available: F, TW, XTW. 				
<p>Modifications Are Not Available</p>				
WIDE SCRIBE MOULDING	WSCRIBE	210		
	WSCRIBE10	264		
<ul style="list-style-type: none"> WSCRIBE: 1 1/32" x 2 1/4" x 96". WSCRIBE10: 1 1/32" x 2 1/4" x 120". Alder will be used for Rustic Alder. Not available in Walnut. Glazes and/or Techniques available: F, TW, XTW, HW, XHW. 				
<p>Custom Modification Options</p> <table border="1"> <tr> <td>F.ALL¹</td> <td>✓</td> </tr> </table> <p>¹ Only available on 10'.</p>			F.ALL ¹	✓
F.ALL ¹	✓			

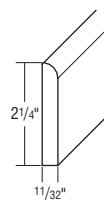
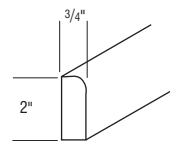

8' mouldings will have 93"-99" of useable length.
10' mouldings will have 117"-123" useable length.

Glazes and Techniques
F = Flooded (see page E•4.)
P = Penned (see page E•4.)
TW = Timeworn (see page E•4.)
XTW = Extra Timeworn (see page E•4.)
HW = Hewn (see page E•4.)
XHW = Extra Hewn (see page E•4.)

Mouldings & Embellishments

Description	Model	Price
SMALL BATTEN MOULDING	SM8	63
	SM10	80

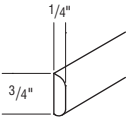

- SM8: 1/4" x 3/4" x 96".
- SM10: 1/4" x 3/4" x 120".
- Alder will be used for Rustic Alder.
- Walnut not available on SM10.
- Glazes and/or Techniques available: F, TW, XTW.

Custom Modification Options

F.ALL ¹
✓

¹ Only available on 10'.

TRADITIONAL BATTEN MOULDING	TBATM	118
	TBATM10	148

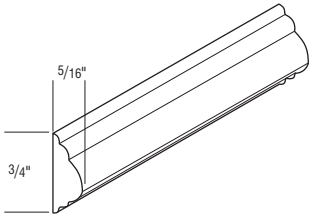

- TBATM: 5/16" x 3/4" x 96".
- TBATM10: 5/16" x 3/4" x 120".
- Alder will be used for Rustic Alder.
- Not available in Walnut.
- Glazes and/or Techniques available: F, P, TW, XTW, HW, XHW.

Custom Modification Options

F.ALL ¹
✓

¹ Only available on 10'.

LARGE BATTEN MOULDING	SM8LG	156
	SM10LG	198

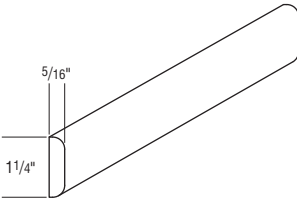

- SM8LG: 5/16" x 1 1/4" x 96".
- SM10LG: 5/16" x 1 1/4" x 120".
- Alder will be used for Rustic Alder.
- Not available in Walnut.
- Glazes and/or Techniques available: F, TW, XTW.

Custom Modification Options

F.ALL ¹
✓

¹ Only available on 10'.

OUTSIDE CORNER MOULDING	OCM8 (Outside corner 8°)	62
	OCM10 (Outside corner 10°)	78

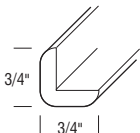

- OCM8: 3/4" x 3/4" x 96".
- OCM10: 3/4" x 3/4" x 120".
- Alder will be used for Rustic Alder.
- Walnut not available on OCM10.
- Glazes and/or Techniques available: F, TW, XTW.

Custom Modification Options

F.ALL ¹
✓

¹ Only available on 10'.

8' mouldings will have 93"-99" of useable length.
10' mouldings will have 117"-123" useable length.

Glazes and Techniques

- F** = Flooded (see page E•4.)
P = Penned (see page E•4.)
TW = Timeworn (see page E•4.)
XTW = Extra Timeworn (see page E•4.)
HW = Hewn (see page E•4.)
XHW = Extra Hewn (see page E•4.)

Description	Model	Price
INSIDE CORNER MOULDING	ICM8	62
	ICM10	78

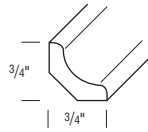

- ICM8: 3/4" x 3/4" x 96".
- ICM10: 3/4" x 3/4" x 120".
- Alder will be used for Rustic Alder.
- Not available in Walnut.
- Glazes and/or Techniques available: F, TW, XTW, HW, XHW.

Custom Modification Options

F.ALL ¹
✓

¹ Only available on 10'.

INSIDE CORNER MOULDING (#2)	ICMA8	149
	ICMA10	187

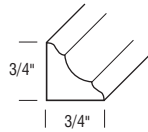

- ICMA8: 3/4" x 3/4" x 96".
- ICMA10: 3/4" x 3/4" x 120".
- Alder will be used for Rustic Alder.
- Not available in Walnut.
- Glazes and/or Techniques available: F, P, TW, XTW, HW, XHW.

Custom Modification Options

F.ALL ¹
✓

¹ Only available on 10'.

OUTSIDE 135° CORNER MOULDING	OC135	144
	OC13510	180

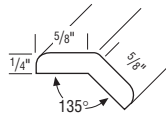

- OC135: 5/8" x 1/4" x 96".
- OC13510: 5/8" x 1/4" x 120".
- Alder will be used for Rustic Alder.
- Not available in Walnut.
- Glazes and/or Techniques available: F, TW, XTW.

Custom Modification Options

F.ALL ¹
✓

¹ Only available on 10'.

QUARTER ROUND MOULDING	QRM	118
	QRM10	148

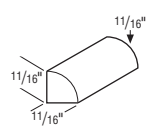

- QRM: 1 1/16" x 1 1/16" x 96".
- QRM10: 1 1/16" x 1 1/16" x 120".
- Alder will be used for Rustic Alder.
- Glazes and/or Techniques available: F, TW, XTW.

Custom Modification Options

F.ALL ¹
✓

¹ Only available on 10'.

SHOE CONVEX INSIDE CORNER MOULDING	SHM8	57
---	-------------	----

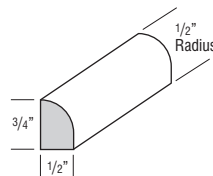

- SHM8: 1/2" x 3/4" x 96".
- Alder will be used for Rustic Alder.
- Not available in Walnut.
- Glazes and/or Techniques available: F, TW, XTW.

Custom Modification Options

F.ALL
✓

Description	Model	Price
-------------	-------	-------

LARGE OUTSIDE CORNER

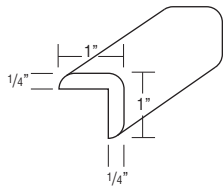

LOSC8	187
LOSC10	235

- LOSC8: 1" x 1" x 96"
- LOSC10: 1" x 1" x 120"
- Alder will be used for Rustic Alder.
- Not available in Walnut.
- Glazes and/or Techniques available: F, TW, XTW.

Custom Modification Options

F.A.L.L. ¹
✓

¹ Only available on 10'.

TRADITIONAL WINDOW CASING

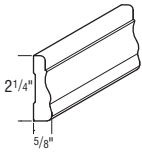

WCT8	253
WCT10	316

- WCT8: 2 1/4" x 5/8" x 96"
- WCT10: 2 1/4" x 5/8" x 120"
- Alder will be used for Rustic Alder.
- Not available in Walnut.
- WCT10 is not available in Quartersawn Oak.
- Glazes and/or Techniques available: F, P, TW, XTW, HW, XHW.

Custom Modification Options

F.A.L.L. ¹
✓

¹ Only available on 10'.

CABINET PANEL EDGE

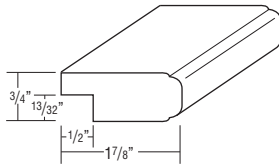

CPE8	220
CPE10	274

- CPE8: 1 7/8" x 3/4" x 96"
- CPE10: 1 7/8" x 3/4" x 120"
- Alder will be used for Rustic Alder.
- Not available in Walnut.
- Glazes and/or Techniques available: F, P, TW, XTW.

Custom Modification Options

F.A.L.L. ¹
✓

¹ Only available on 10'.

BASE SHOE MOULDING

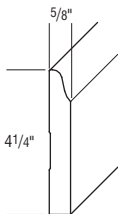

BSM (Base Shoe 8')	301
BSM10 (Base Shoe 10')	376

- BSM: 5/8" x 4 1/4" x 96"
- BSM10: 5/8" x 4 1/4" x 120"
- Designed for use only with Flush Toekick.
- Glazes and/or Techniques available: F, TW, XTW, HW, XHW.

Custom Modification Options

F.A.L.L. ¹
✓

¹ Only available on 10'.

Description	Model	Price
-------------	-------	-------

DECORATIVE BASEBOARD MOULDING

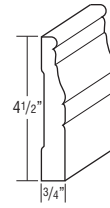

BBM8	390
BBM10	488

- BBM8: 3/4" x 4 1/2" x 96"
- BBM10: 3/4" x 4 1/2" x 120"
- Walnut not available on BBM10.
- Glazes and/or Techniques available: F, P, TW, XTW.

Custom Modification Options

F.A.L.L. ¹
✓

¹ Only available on 10'.

BASEBOARD MOULDING SHAKER

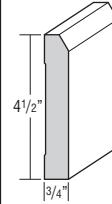

BBMSH8	255
BBMSH10	344

- BBMSH8: 3/4" x 4 1/2" x 96"
- BBMSH10: 3/4" x 4 1/2" x 120"
- Not available in Walnut.
- BBMSH10 only available in Cherry and Maple.
- Glazes and/or Techniques available: F, TW, XTW, HW, XHW.

Custom Modification Options

F.A.L.L.
✓

BASEBOARD MOULDING SCULPTED

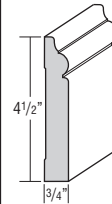

BBMSC	255
--------------	-----

- BBMSC: 3/4" x 4 1/2" x 96"
- Not available in Walnut.
- Glazes and/or Techniques available: F, P, TW, XTW, HW, XHW.

Custom Modification Options

F.A.L.L.
✓

DECO BASEBOARD MOULDING

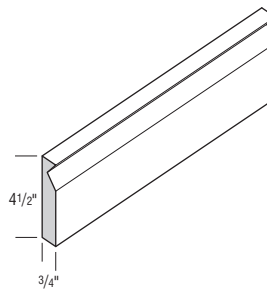

DECOBBM	935
----------------	-----

- 4 1/2" x 3/4" x 96"
- Alder will be used for Rustic Alder.
- Not available in Quartersawn Oak or Walnut.

Custom Modification Options

F.A.L.L.
✓

8' mouldings will have 93"-99" of useable length.
10' mouldings will have 117"-123" useable length.

Glazes and Techniques

- F = Flooded (see page E•4.)
- P = Penned (see page E•4.)
- TW = Timeworn (see page E•4.)
- XTW = Extra Timeworn (see page E•4.)
- HW = Hewn (see page E•4.)
- XHW = Extra Hewn (see page E•4.)

Stack Moulding Kits

Description

Model

Price

- Moulding stacks do not ship assembled; field assembly is required. Assembly instructions can be viewed in 20/20 spec pages and will also ship with moulding kits.
- When ordered as a kit, only one finish can be specified. To order with more than one finish, moulding pieces must be ordered separately.
- How to place a stack moulding in 20/20:

- Moulding
- Top Mouldings or Bottom Mouldings
- Stacked Mouldings
- Drag and drop desired moulding stack onto wall cabinets

MOULDING STACK 5

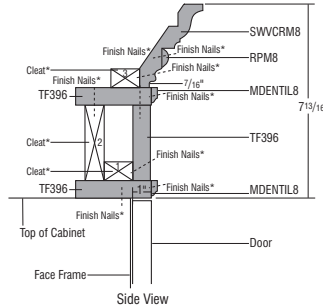
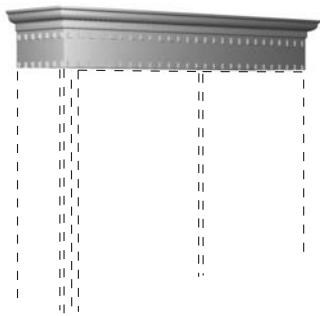

STKMLD5D

1525

- Includes:
 - 1 SWVCRM8
 - 1 RPM8
 - 2 MDENTIL8
 - 3 TF396
- Assembly instructions available upon request.
- *Cleats and finish nails not included.
- Not available in Walnut.

MOULDING STACK 6

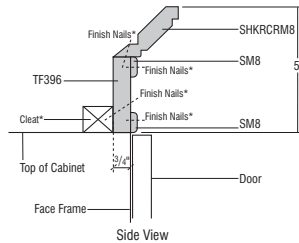
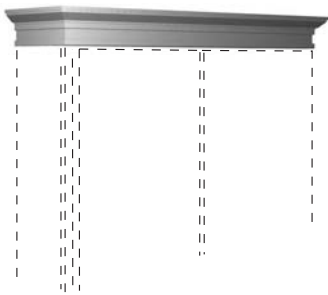

STKMLD6D

674

- Includes:
 - 1 SHKRCRM8
 - 2 SM8
 - 1 TF396
- Assembly instructions available upon request.
- *Cleats and finish nails not included.
- Not recommended for use when taking application to the ceiling.
- Not available in Walnut.

MOULDING STACK 7

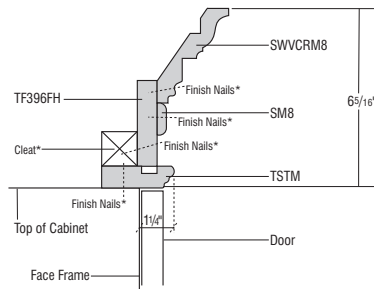
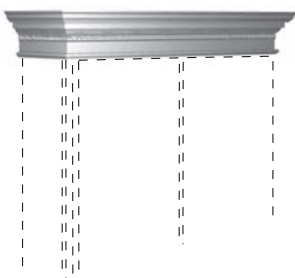

STKMLD7D

1247

- Includes:
 - 1 SWVCRM8
 - 1 SM8
 - 1 TF396
 - 1 TSTM
- Assembly instructions available upon request.
- *Cleats and finish nails not included.
- Not available in Walnut.

MOULDING STACK 11

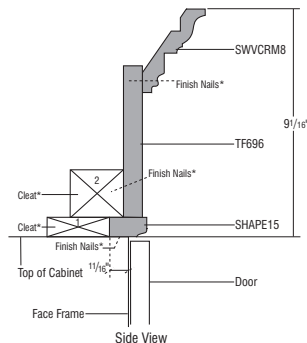

STKMLD11D

893

- Includes:
 - 1 SWVCRM8
 - 1 TF696
 - 1 SHAPE15
- Assembly instructions available upon request.
- *Cleats and finish nails not included.

Description	Model	Price
<ul style="list-style-type: none"> Moulding stacks do not ship assembled; field assembly is required. Assembly instructions can be viewed in 20/20 spec pages and will also ship with moulding kits. When ordered as a kit, only one finish can be specified. To order with more than one finish, moulding pieces must be ordered separately. How to place a stack moulding in 20/20: 	<ul style="list-style-type: none"> Moulding Top Mouldings or Bottom Mouldings Stacked Mouldings Drag and drop desired moulding stack onto wall cabinets 	

MOULDING STACK 19

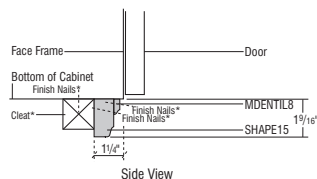
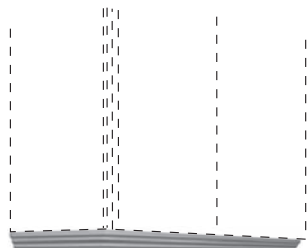

STKMULD19D 439

- Includes:
 - 1 MDENTIL8
 - 1 SHAPE15
- Assembly instructions available upon request.
- *Cleats and finish nails not included.
- Not available in Walnut.

MOULDING STACK 22

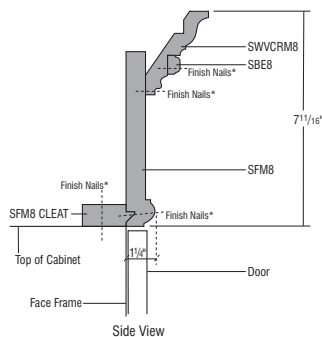
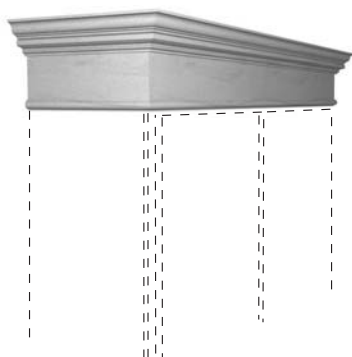

STKMULD22D 1069

- Includes:
 - 1 SWVCRM8
 - 1 SBE8
 - 1 SFM8
- Assembly instructions available upon request.
- *Cleats and finish nails not included.
- Not available in Walnut.

MOULDING STACK 23

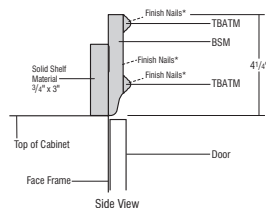
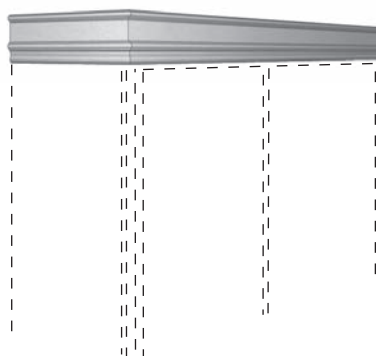

STKMULD23D 648

- Includes:
 - 2 TBATM
 - 1 SHEFLSD
 - 1 BSM
- Assembly instructions available upon request.
- *Cleats and finish nails not included.
- Not available in Walnut.

Stack Moulding Kits

Description

- Moulding stacks do not ship assembled; field assembly is required. Assembly instructions can be viewed in 20/20 spec pages and will also ship with moulding kits.
- When ordered as a kit, only one finish can be specified. To order with more than one finish, moulding pieces must be ordered separately.
- How to place a stack moulding in 20/20:

- Moulding
- Top Mouldings or Bottom Mouldings
- Stacked Mouldings
- Drag and drop desired moulding stack onto wall cabinets

Model

Price

MOULDING STACK 25

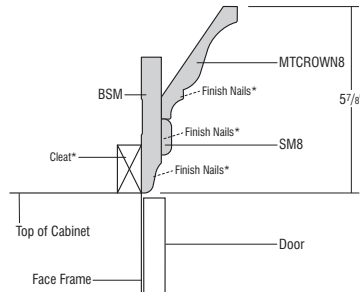
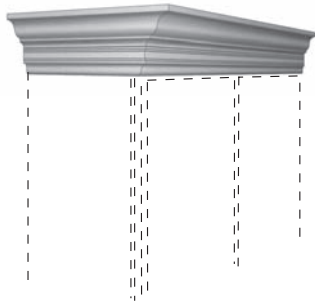

STKMLD25D

1068

- Includes:
 - 1 MTCROWN8
 - 1 SM8
 - 1 BSM
- Assembly instructions available upon request.
- *Cleats and finish nails not included.

MOULDING STACK 26

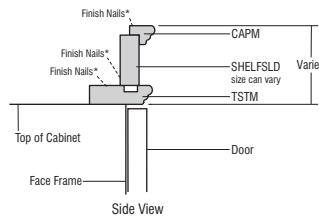
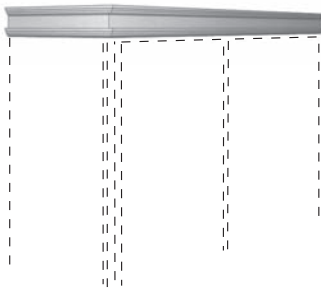

STKMLD26D

498

- Includes:
 - 1 CAPM
 - 1 SHELFSLD
 - 1 TSTM
- Assembly instructions available upon request.
- *Cleats and finish nails not included.
- Not recommended for use when taking application to the ceiling.
- Not available in Walnut.

MOULDING STACK 27

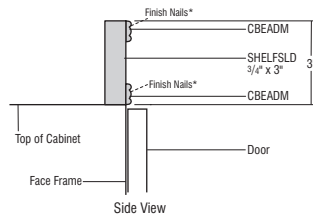
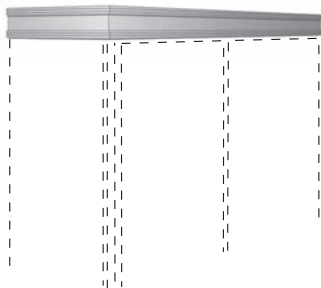

STKMLD27D

456

- Includes:
 - 2 CBEADM
 - 1 SHELFSLD
- Assembly instructions available upon request.
- *Cleats and finish nails not included.
- Not available in Walnut.

MOULDING STACK 28

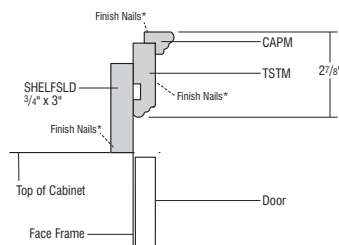
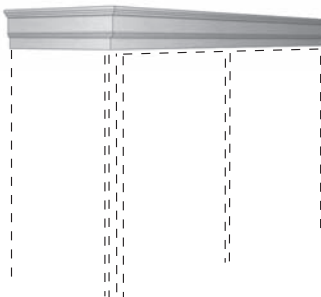

STKMLD28D

498

- Includes:
 - 1 CAPM
 - 1 TSTM
 - 1 SHELFSLD
- Assembly instructions available upon request.
- *Cleats and finish nails not included.
- Not recommended for use when taking application to the ceiling.
- Not available in Walnut.

Description

- Moulding stacks do not ship assembled; field assembly is required. Assembly instructions can be viewed in 20/20 spec pages and will also ship with moulding kits.
- When ordered as a kit, only one finish can be specified. To order with more than one finish, moulding pieces must be ordered separately.
- How to place a stack moulding in 20/20:

- Moulding
- Top Mouldings or Bottom Mouldings
- Stacked Mouldings
- Drag and drop desired moulding stack onto wall cabinets

Model

Price

MOULDING STACK 31

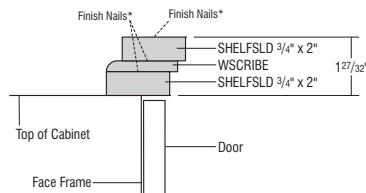
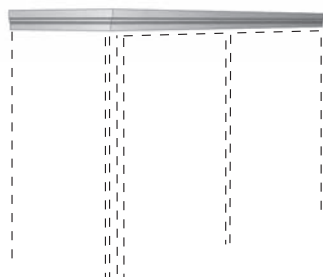

STKMULD31D

435

- Includes:
 - 2 SHELFSLD
 - 1 WSCRIBE
- Assembly instructions available upon request.
- *Cleats and finish nails not included.
- Not recommended for use when taking application to the ceiling.
- Not available in Walnut.

MOULDING STACK 32

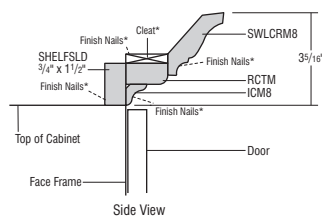
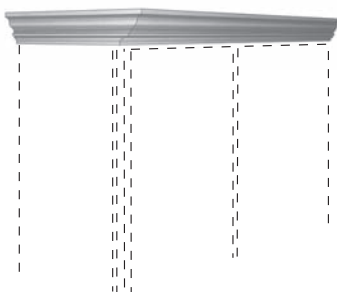

STKMULD32D

534

- Includes:
 - 1 SWLCRM8
 - 1 SHELFSLD
 - 1 RCTM
 - 1 ICM8
- Assembly instructions available upon request.
- *Cleats and finish nails not included.
- Not available in Walnut.

MOULDING STACK 33

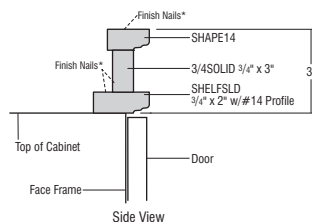
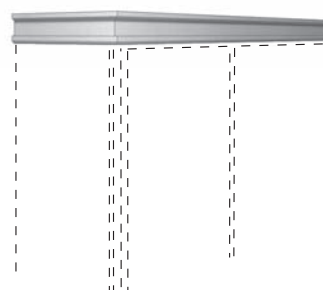

STKMULD33D

391

- Includes:
 - 1 SHAPE14
 - 1 SHELFSLD
 - 1 3/4SOLID
- Assembly instructions available upon request.
- *Cleats and finish nails not included.

MOULDING STACK 36

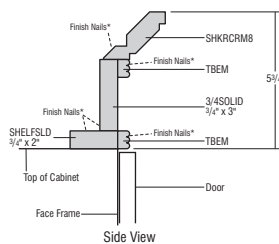
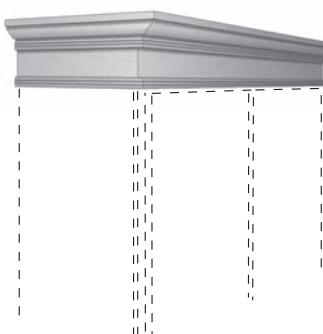

STKMULD36D

806

- Includes:
 - 1 SHKRCRM8
 - 2 TBEM
 - 1 SHELFSLD
 - 1 3/4SOLID
- Assembly instructions available upon request.
- *Cleats and finish nails not included.
- Not recommended for use when taking application to the ceiling.
- Not available in Walnut.

Stack Moulding Kits

Description

- Moulding stacks do not ship assembled; field assembly is required. Assembly instructions can be viewed in 20/20 spec pages and will also ship with moulding kits.
- When ordered as a kit, only one finish can be specified. To order with more than one finish, moulding pieces must be ordered separately.
- How to place a stack moulding in 20/20:

- Moulding
- Top Mouldings or Bottom Mouldings
- Stacked Mouldings
- Drag and drop desired moulding stack onto wall cabinets

Model

Price

MOULDING STACK 37

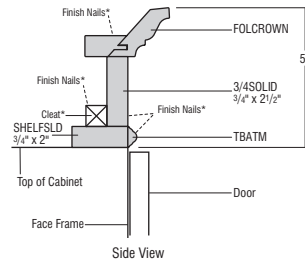

STKMLD37D

606

- Includes:
1 FOLCROWN
1 SHELFSLD
1 3/4SOLID
1 TBATM
- Assembly instructions available upon request.
- *Cleats and finish nails not included.
- Not recommended for use when taking application to the ceiling.
- Not available in Walnut.

MOULDING STACK 38

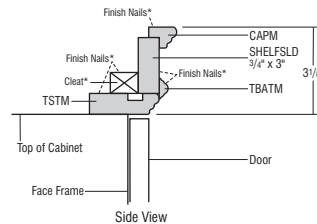
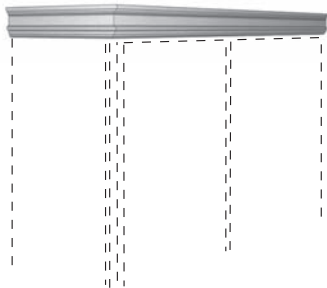

STKMLD38D

618

- Includes:
1 CAPM
1 SHELFSLD
1 TBATM
1 TSTM
- Assembly instructions available upon request.
- *Cleats and finish nails not included.
- Not recommended for use when taking application to the ceiling.
- Not available in Walnut.

MOULDING STACK 39

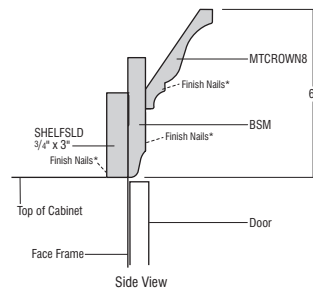
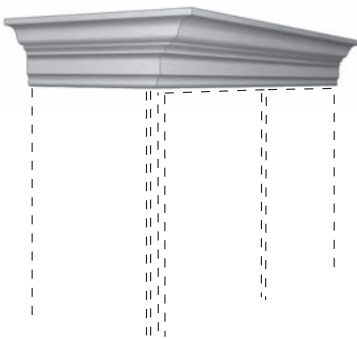

STKMLD39D

787

- Includes:
1 MTCROWN8
1 BSM
1 SHELFSLD
- Assembly instructions available upon request.
- *Cleats and finish nails not included.

MOULDING STACK 40

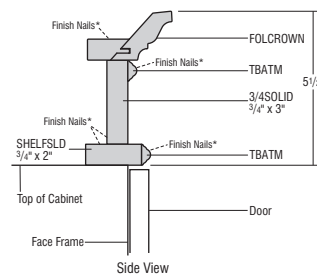

STKMLD40D

726

- Includes:
1 FOLCROWN
1 SHELFSLD
1 3/4SOLID
2 TBATM
- Assembly instructions available upon request.
- *Cleats and finish nails not included.
- Not recommended for use when taking application to the ceiling.
- Not available in Walnut.

Description

Model

Price

- Moulding stacks do not ship assembled; field assembly is required. Assembly instructions can be viewed in 20/20 spec pages and will also ship with moulding kits.
- When ordered as a kit, only one finish can be specified. To order with more than one finish, moulding pieces must be ordered separately.
- How to place a stack moulding in 20/20:

- Moulding
- Top Mouldings or Bottom Mouldings
- Stacked Mouldings
- Drag and drop desired moulding stack onto wall cabinets

MOULDING STACK 41

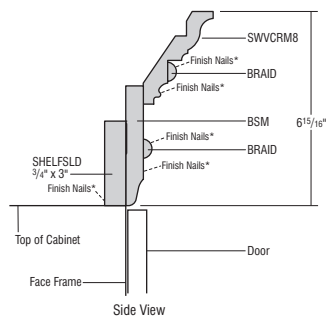
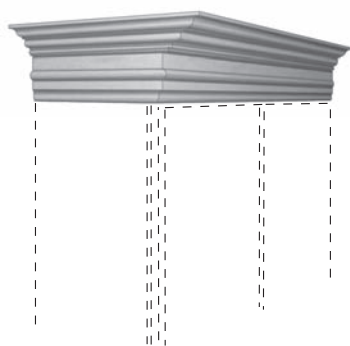

STKMLD41D

1046

- Includes:
 - 1 SWVCRM8
 - 2 BRAID
 - 1 BSM
 - 1 SHELFSLD
- Assembly instructions available upon request.
- *Cleats and finish nails not included.
- Not available in Walnut.

MOULDING STACK 42

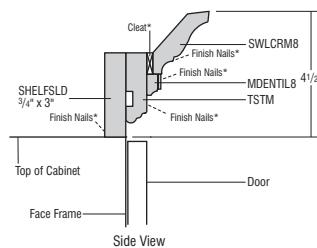

STKMLD42D

934

- Includes:
 - 1 SWLCRM8
 - 1 MDENTIL8
 - 1 TSTM
 - 1 SHELFSLD
- Assembly instructions available upon request.
- *Cleats and finish nails not included.
- Not available in Walnut.

MOULDING STACK 43

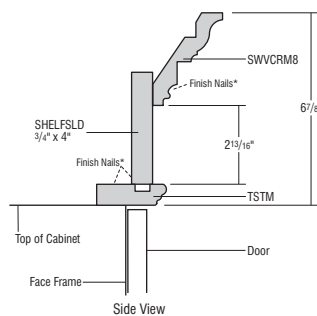
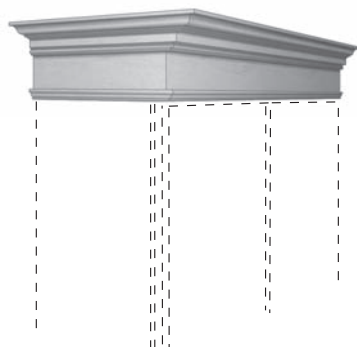

STKMLD43D

744

- Includes:
 - 1 SWVCRM8
 - 1 SHELFSLD
 - 1 TSTM
- Assembly instructions available upon request.
- *Cleats and finish nails not included.
- Not available in Walnut.

MOULDING STACK 44

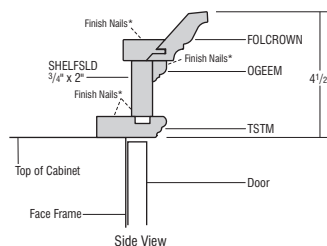

STKMLD44D

738

- Includes:
 - 1 FOLCROWN
 - 1 OGEEEM
 - 1 SHELFSLD
 - 1 TSTM
- Assembly instructions available upon request.
- *Cleats and finish nails not included.
- Not recommended for use when taking application to the ceiling.
- Not available in Walnut.

Mouldings & Embellishments

Description	Model	Price
-------------	-------	-------

ROSETTES

TRADITIONAL ROSETTE

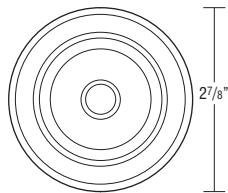

TROSETTE	90
-----------------	----

- 2 7/8" diameter x 3/8" thick.
- Alder will be used for Rustic Alder.
- Beech will be used for Quartersawn Oak.
- Not available in Walnut.
- Glazes and/or Techniques available: F, P, HW, XHW.

Custom Modification Options

F,ALL
✓

FLOWER ROSETTE

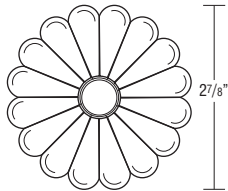

ROSETTEFLW	90
-------------------	----

- 2 7/8" diameter x 3/8" thick.
- Beech will be used for Quartersawn Oak.
- Not available in Alder, Rustic Alder, or Walnut.
- Glazes and/or Techniques available: F, P, HW, XHW.

Custom Modification Options

F,ALL
✓

GRAPE ROSETTE

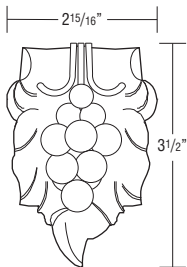

GRO	173
------------	-----

- 2 5/16" wide x 3 1/2" high x 5/8" thick.
- Alder will be used for Rustic Alder.
- Beech will be used for Quartersawn Oak.
- Not available in Walnut.
- Glazes and/or Techniques available: F, P, HW, XHW.

Custom Modification Options

F,ALL
✓

ACANTHUS ROSETTE

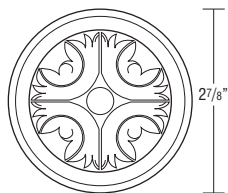

ROSETTEACA	173
-------------------	-----

- 2 7/8" diameter x 3/8" thick.
- Beech will be used for Quartersawn Oak.
- Not available in Alder, Rustic Alder, or Walnut.
- Glazes and/or Techniques available: F, P, HW, XHW.

Custom Modification Options

F,ALL
✓

MISSION ROSETTE

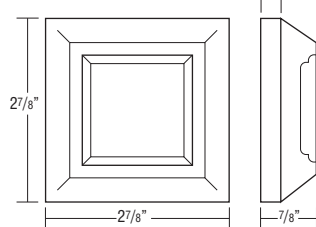

ROSETTEMIS	326
-------------------	-----

- 2 7/8" wide x 2 7/8" high.
- Alder will be used for Rustic Alder.
- Oak will be used for Quartersawn Oak.
- Not available in Walnut.
- Hand-carved.
- Glazes and/or Techniques available: F, P, HW, XHW.

Custom Modification Options

F,ALL
✓

Description	Model	Price
-------------	-------	-------

SMALL GAELIC ROSETTE

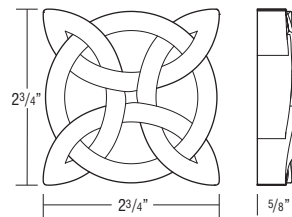

ROSETTEGAE	328
-------------------	-----

- 2 3/4" x 5/8" x 2 3/4".
- Alder will be used for Rustic Alder.
- Not available in Quartersawn Oak or Walnut.

Custom Modification Options

F,ALL
✓

PEAKED SMALL ROSETTE

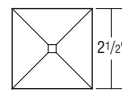

ROSETTESMPK	103
--------------------	-----

- 2 1/2" wide x 2 1/2" high.
- Rustic hammered iron finish.
- 7/32" x 1/2" deep installation socket.

Modifications Are Not Available

PEAKED LARGE ROSETTE

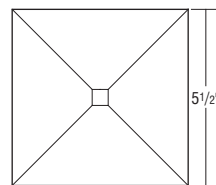

ROSETTELGPK	139
--------------------	-----

- 5 1/2" wide x 5 1/2" high.
- Rustic hammered iron finish.
- 7/32" x 1/2" deep installation socket.

Modifications Are Not Available

ACCESSORY NAILS

ACCESSORY NAIL

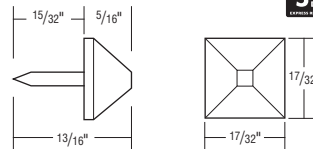

ACCNAIL	47
----------------	----

- Rustic hammered iron finish.
- Sold in sets of ten.

Modifications Are Not Available

SPLIT TURN END/CAP

3" SPLIT TURNING CENTER

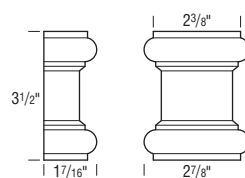

3SPRINGCTR	95
-------------------	----

- 2 7/8" x 1 13/32" x 3 1/2".
- Alder will be used for Rustic Alder.
- Not available in Quartersawn Oak or Walnut.

Custom Modification Options

F,ALL
✓

Glazes and Techniques

- F = Flooded (see page E•4.)
- P = Penned (see page E•4.)
- TW = Timeworn (see page E•4.)
- XTW = Extra Timeworn (see page E•4.)
- HW = Hewn (see page E•4.)
- XHW = Extra Hewn (see page E•4.)

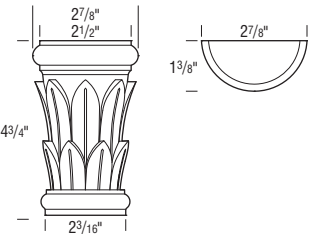
Description	Model	Price		
3" SPLIT TURNING ACANTHUS	3SPTRINGACA	202		
	<ul style="list-style-type: none"> • 2 7/8" x 1 3/8" x 4 3/4" • Alder will be used for Rustic Alder. • Not available in Quartersawn Oak or Walnut. 	<p>Custom Modification Options</p> <table border="1"> <tr> <td>F.ALL</td> <td>✓</td> </tr> </table>	F.ALL	✓
F.ALL	✓			

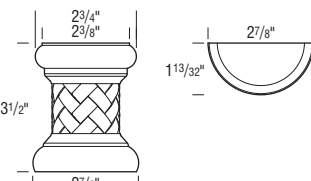
3" SPLIT TURNING WEAVED	3SPTRINGWV	187		
	<ul style="list-style-type: none"> • 3" x 1 7/16" x 3 1/2" • Alder will be used for Rustic Alder. • Not available in Quartersawn Oak or Walnut. 	<p>Custom Modification Options</p> <table border="1"> <tr> <td>F.ALL</td> <td>✓</td> </tr> </table>	F.ALL	✓
F.ALL	✓			

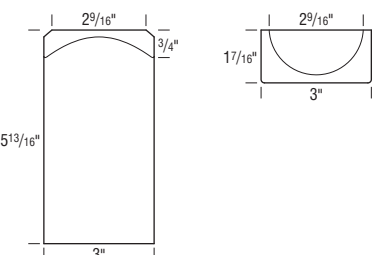
3" SPLIT TURNING BLOCK	3SPTRINGBLK	133		
	<ul style="list-style-type: none"> • 3" x 1 7/16" x 5 3/4" • Alder will be used for Rustic Alder. • Not available in Quartersawn Oak or Walnut. 	<p>Custom Modification Options</p> <table border="1"> <tr> <td>F.ALL</td> <td>✓</td> </tr> </table>	F.ALL	✓
F.ALL	✓			

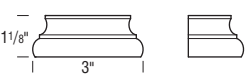
3" SPLIT TURNING CAPITOL	3SPTRINGCAP	92		
	<ul style="list-style-type: none"> • 3" x 1 7/16" x 1 1/4" • Alder will be used for Rustic Alder. • Not available in Quartersawn Oak or Walnut. 	<p>Custom Modification Options</p> <table border="1"> <tr> <td>F.ALL</td> <td>✓</td> </tr> </table>	F.ALL	✓
F.ALL	✓			

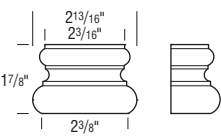
3" SPLIT TURNING SPINDLE	3SPTRINGSPNDL	90		
	<ul style="list-style-type: none"> • 2 7/8" x 1 7/16" x 1 3/4" • Alder will be used for Rustic Alder. • Not available in Quartersawn Oak or Walnut. 	<p>Custom Modification Options</p> <table border="1"> <tr> <td>F.ALL</td> <td>✓</td> </tr> </table>	F.ALL	✓
F.ALL	✓			

Description	Model	Price
SPLIT TURNING SYSTEMS		

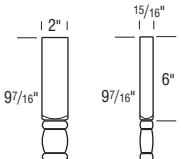
END	SPTRINGEND	114/PAIR
	<ul style="list-style-type: none"> • Alder will be used for Rustic Alder. • Oak will be used for Quartersawn Oak. • Not available in Walnut. • Sold in pairs. • Glazes and/or Techniques available: F, P, TW, XTW, HW, XHW. 	<p>Modifications Are Not Available</p>

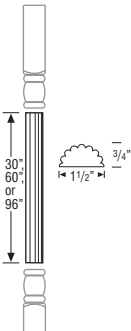
REED	SPTRINGREED30	114
	SPTRINGREED60	167
	SPTRINGREED96	212
	<ul style="list-style-type: none"> • Alder will be used for Rustic Alder. • Oak will be used for Quartersawn Oak. • Not available in Walnut. • Sold in 30", 60", or 96" lengths. • Ends (SPTRINGEND) sold separately. • Glazes and/or Techniques available: F, P, TW, XTW. 	<p>Modifications Are Not Available</p>

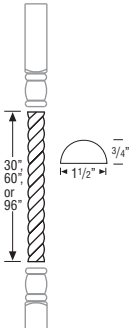
ROPE	SPTRINGROPE30	182
	SPTRINGROPE60	326
	SPTRINGROPE96	433
	<ul style="list-style-type: none"> • Alder will be used for Rustic Alder. • Oak will be used for Quartersawn Oak. • Not available in Walnut. • Sold in 30", 60", or 96" lengths. • Ends (SPTRINGEND) sold separately. • Glazes and/or Techniques available: F, P, TW, XTW, HW, XHW. 	<p>Modifications Are Not Available</p>

Glazes and Techniques
F = Flooded (see page E•4.)
P = Penned (see page E•4.)
TW = Timeworn (see page E•4.)
XTW = Extra Timeworn (see page E•4.)
HW = Hewn (see page E•4.)
XHW = Extra Hewn (see page E•4.)

Mouldings & Embellishments

Description	Model	Price
SPOOL	SPTRINGSPOOL30	114
	SPTRINGSPOOL60	167
	SPTRINGSPOOL96	212

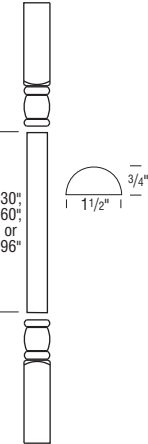

- Alder will be used for Rustic Alder.
- Oak will be used for Quartersawn Oak.
- Not available in Walnut.
- Sold in 30", 60", or 96" lengths.
- Ends (SPTRINGEND) sold separately.
- Glazes and/or Techniques available: F, TW, XTW.

Modifications Are Not Available

VALANCES		
BAROQUE VALANCE	BARV38	866

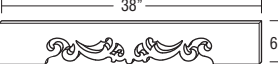

- 6" x 5/8" x 38".
- Alder will be used for Rustic Alder.
- Not available in Quartersawn Oak or Walnut.

Custom Modification Options

F	ALL	IH	IW	OONLY	RH	RW
✓						

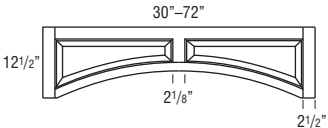
RAISED PANEL VALANCE		
	RPV30	1254
	JRPV36	1341
	JRPV42	1396
	RPV48	1583
	RPV54	1755
	RPV60	1926
	RPV72	2276

- There is 8" from the top edge to the center of the arch. There is 4 1/2" from the center of the arch to the bottom of the part.
- Sides trimmable up to 1 3/4".
- Not available in Walnut.
- Glazes and/or Techniques available: F, P, TW, XTW, HW, XHW.

Modifications Are Not Available

Glazes and Techniques

F = Flooded (see page E•4.)

P = Penned (see page E•4.)

TW = Timeworn (see page E•4.)

XTW = Extra Timeworn (see page E•4.)

HW = Hewn (see page E•4.)

XHW = Extra Hewn (see page E•4.)

Description	Model	Price
RECESSED PANEL VALANCE	RCPV30	1236
	RCPV36	1341
	RCPV42	1396
	RCPV48	1583
	RCPV54	1755
	RCPV60	1926
	RCPV72	2276

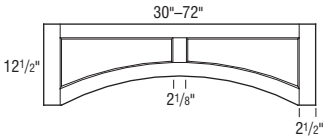

- There is 8" from the top edge to the center of the arch. There is 4 1/2" from the center of the arch to the bottom of the part.
- Sides trimmable up to 1 3/4".
- Not available in Walnut.
- Glazes and/or Techniques available: F, P, TW, XTW, HW, XHW.

Modifications Are Not Available

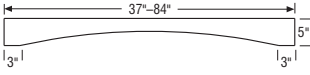
ARCH VALANCE		
	AV37	155
	AV43	191
	AV49	214
	AV55	253
	AV61	279
	AV67	295
	AV73	301
	AV79	309
	AV84	312

- Alder will be used for Rustic Alder.
- There is 2 5/16" from the top edge to the center of the arch.
- Increased Heights available in 1/4" increments from 5 1/4" to 12".
- Reduced Heights available in 1/4" increments from 4 1/2" to 4 3/4".
- Height must be less than or equal to 6" if width is more than 60".
- Reduced Widths available in 1/4" increments from 12" to 83 3/4".
- Increased Widths available in 1/4" increments. See page G•46 for details.
- Glazes and/or Techniques available: TW, XTW.

Custom Modification Options

F	ALL	IH ¹	IW ²	OONLY	RH	RW
✓		✓	✓		✓	✓

¹ Not available on widths over 60".
² Only available on 84" wide.

Description	Model	Price
STRAIGHT VALANCE 	VV37	139
	VV43	177
	VV49	203
	VV55	241
	VV61	278
	VV67	280
	VV73	287
	VV79	299
	VV84	303

- Alder will be used for Rustic Alder.
- Increased Heights available in 1/4" increments from 5 1/4" to 12".
- Reduced Heights available in 1/4" increments from 4 1/2" to 4 3/4".
- Height must be less than or equal to 6" if width is more than 60".
- Reduced Widths available in 1/4" increments from 12" to 83 3/4".
- Increased Widths available in 1/4" increments. See page G•46 for details.
- All edges finished excluding the back.
- Glazes and/or Techniques available: TW, XTW.

Custom Modification Options

F	ALL	IH	IW ¹	RH	RW
✓	✓	✓	✓	✓	✓

¹ Not available on widths over 60".
² Only available on 84" wide.

Description	Model	Price
NEW STYLE B VALANCE 	V37B	155
	V43B	191
	V49B	214
	V55B	253
	V61B	279
	V67B	295
	V73B	301
	V79B	309
	V84B	312

- Alder will be used for Rustic Alder.
- Increased Heights available in 1/4" increments from 5 1/4" to 12".
- Height must be less than or equal to 6" if width is more than 60".
- Increased Widths available in 1/4" increments. See page G•46 for details.
- Reduced Widths available in 1/4" increments from 12" to 83 3/4".
- All edges finished excluding the back.
- Glazes and/or Techniques available: TW, XTW

Custom Modification Options

F	ALL	IH	IW ¹	RH	RW
✓	✓	✓	✓	✓	✓

¹ Only available on 84" wide.

Description	Model	Price
NEW STYLE D VALANCE 	V37D	155
	V43D	191
	V49D	214
	V55D	253
	V61D	279
	V67D	295
	V73D	301
	V79D	309
	V84D	312

- Alder will be used for Rustic Alder.
- Increased Heights available in 1/4" increments from 5 1/4" to 12".
- Height must be less than or equal to 6" if width is more than 60".
- Increased Widths available in 1/4" increments. See page G•46 for details.
- Reduced Widths available in 1/4" increments from 12" to 83 3/4".
- All edges finished excluding the back.
- Glazes and/or Techniques available: TW, XTW.

Custom Modification Options

F	ALL	IH	IW ¹	RH	RW
✓	✓	✓	✓	✓	✓

¹ Only available on 84" wide.

Description	Model	Price
NEW STYLE E VALANCE 	V37E	155
	V43E	191
	V49E	214
	V55E	253
	V61E	279
	V67E	295
	V73E	301
	V79E	309
	V84E	312

- Alder will be used for Rustic Alder.
- Increased Heights available in 1/4" increments from 5 1/4" to 12".
- Height must be less than or equal to 6" if width is more than 60".
- Increased Widths available in 1/4" increments. See page G•46 for details.
- Reduced Widths available in 1/4" increments from 12" to 83 3/4".
- All edges finished excluding the back.
- Glazes and/or Techniques available: TW, XTW.

Custom Modification Options

F	ALL	IH	IW ¹	RH	RW
✓	✓	✓	✓	✓	✓

¹ Only available on 84" wide.

Glazes and Techniques

- F** = Flooded (see page E•4.)
- P** = Penned (see page E•4.)
- TW** = Timeworn (see page E•4.)
- XTW** = Extra Timeworn (see page E•4.)
- HW** = Hewn (see page E•4.)
- XHW** = Extra Hewn (see page E•4.)

Mouldings & Embellishments

Description	Model	Price
NEW STYLE H VALANCE	V37H	155
	V43H	191
	V49H	214
	V55H	253
	V61H	279
	V67H	295
	V73H	301
	V79H	309
	V84H	312

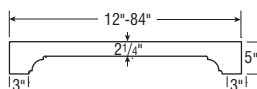

- Alder will be used for Rustic Alder.
- Increased Heights available in 1/4" increments from 5 1/4" to 12".
- Height must be less than or equal to 6" if width is more than 60".
- Increased Widths available in 1/4" increments. See page G•46 for details.
- Reduced Widths available in 1/4" increments from 12" to 83 3/4".
- All edges finished excluding the back.
- Glazes and/or Techniques available: TW, XTW.

Custom Modification Options

F	A	I	H	I	W	R	H	R	W
<input checked="" type="checkbox"/>	<input checked="" type="checkbox"/>	<input checked="" type="checkbox"/>	<input checked="" type="checkbox"/>	<input checked="" type="checkbox"/>	<input checked="" type="checkbox"/>	<input checked="" type="checkbox"/>	<input checked="" type="checkbox"/>	<input checked="" type="checkbox"/>	<input checked="" type="checkbox"/>

¹ Only available on 84" wide.

Description	Model	Price
NEW STYLE J VALANCE	V37J	155
	V43J	191
	V49J	214
	V55J	253
	V61J	279
	V67J	295
	V73J	301
	V79J	309
	V84J	312

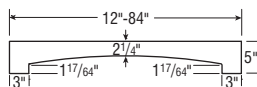

- Alder will be used for Rustic Alder.
- Increased Heights available in 1/4" increments from 5 1/4" to 12".
- Height must be less than or equal to 6" if width is more than 60".
- Increased Widths available in 1/4" increments. See page G•46 for details.
- Reduced Widths available in 1/4" increments from 12" to 83 3/4".
- All edges finished excluding the back.
- Glazes and/or Techniques available: TW, XTW.

Custom Modification Options

F	A	I	H	I	W	R	H	R	W
<input checked="" type="checkbox"/>	<input checked="" type="checkbox"/>	<input checked="" type="checkbox"/>	<input checked="" type="checkbox"/>	<input checked="" type="checkbox"/>	<input checked="" type="checkbox"/>	<input checked="" type="checkbox"/>	<input checked="" type="checkbox"/>	<input checked="" type="checkbox"/>	<input checked="" type="checkbox"/>

¹ Only available on 84" wide.

Description	Model	Price
NEW STYLE K VALANCE	V37K	155
	V43K	191
	V49K	214
	V55K	253
	V61K	279
	V67K	295
	V73K	301
	V79K	309
	V84K	312

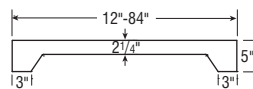

- Alder will be used for Rustic Alder.
- Increased Heights available in 1/4" increments from 5 1/4" to 12".
- Height must be less than or equal to 6" if width is more than 60".
- Increased Widths available in 1/4" increments. See page G•46 for details.
- Reduced Widths available in 1/4" increments from 12" to 83 3/4".
- All edges finished excluding the back.
- Glazes and/or Techniques available: TW, XTW.

Custom Modification Options

F	A	I	H	I	W	R	H	R	W
<input checked="" type="checkbox"/>	<input checked="" type="checkbox"/>	<input checked="" type="checkbox"/>	<input checked="" type="checkbox"/>	<input checked="" type="checkbox"/>	<input checked="" type="checkbox"/>	<input checked="" type="checkbox"/>	<input checked="" type="checkbox"/>	<input checked="" type="checkbox"/>	<input checked="" type="checkbox"/>

¹ Only available on 84" wide.

Description	Model	Price
NEW STYLE L VALANCE	V37L	155
	V43L	191
	V49L	214
	V55L	253
	V61L	279
	V67L	295
	V73L	301
	V79L	309
	V84L	312

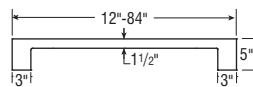

- Alder will be used for Rustic Alder.
- Increased Heights available in 1/4" increments from 5 1/4" to 12".
- Height must be less than or equal to 6" if width is more than 60".
- Increased Widths available in 1/4" increments. See page G•46 for details.
- Reduced Widths available in 1/4" increments from 12" to 83 3/4".
- All edges finished excluding the back.
- Glazes and/or Techniques available: TW, XTW.

Custom Modification Options

F	A	I	H	I	W	R	H	R	W
<input checked="" type="checkbox"/>	<input checked="" type="checkbox"/>	<input checked="" type="checkbox"/>	<input checked="" type="checkbox"/>	<input checked="" type="checkbox"/>	<input checked="" type="checkbox"/>	<input checked="" type="checkbox"/>	<input checked="" type="checkbox"/>	<input checked="" type="checkbox"/>	<input checked="" type="checkbox"/>

¹ Only available on 84" wide.

Glazes and Techniques

- F = Flooded (see page E•4.)
- P = Penned (see page E•4.)
- TW = Timeworn (see page E•4.)
- XTW = Extra Timeworn (see page E•4.)
- HW = Hewn (see page E•4.)
- XHW = Extra Hewn (see page E•4.)

Description	Model	Price
OVERLAY VALANCE (FULL OVERLAY STYLES ONLY)	OSV37	287
	OSV43	365
	OSV49	383
	OSV55	418
	OSV61	463
	OSV67	527
	OSV73	561
	OSV79	609
	OSV84	638

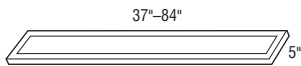

- Alder will be used for Rustic Alder.
- Increased Heights available in 1/4" increments from 5 1/4" to 12".
- Reduced Heights available in 1/4" increments from 4 1/2" to 4 3/4".
- Height must be less than 12" if width of 60" is required.
- Increased Widths available in 1/4" increments. See page G-46 for details.
- All edges finished excluding the back.
- Not available in Walnut.
- Glazes and/or Techniques available: F, TW, XTW, HW, XHW.

Custom Modification Options

FALL	IH	IW ¹	RH	RW
<input checked="" type="checkbox"/>	<input checked="" type="checkbox"/>	<input checked="" type="checkbox"/>	<input checked="" type="checkbox"/>	<input checked="" type="checkbox"/>

¹ Only available on 84" wide.

DECORATIVE ONLAYS/OVERLAYS

GRAPE	GROVLY	1166
-------	--------	------

- 20" wide x 4 1/2" high x 5/8" deep.
- Alder will be used for Rustic Alder.
- Beech will be used for Quartersawn Oak.
- Not available in Walnut.
- Glazes and/or Techniques available: F, P, HW, XHW.

Modifications
Are Not
Available

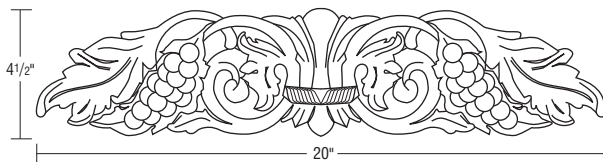

ACANTHUS	ACOVLY	1166
----------	--------	------

- 20" wide x 4 1/2" high x 5/8" deep.
- Alder will be used for Rustic Alder.
- Beech will be used for Quartersawn Oak.
- Not available in Walnut.
- Glazes and/or Techniques available: F, P, HW, XHW.

Modifications
Are Not
Available

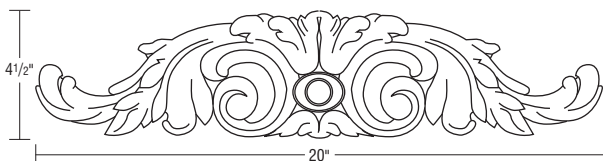

Description	Model	Price
DECORATIVE ORNAMENTS		

ACANTHUS	ACO	390
----------	-----	-----

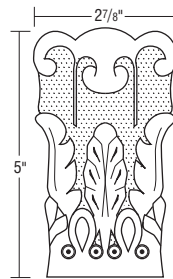

- 27/8" wide x 5" high x 1 1/2" deep.
- Not available in Alder, Rustic Alder, or Walnut.
- Beech will be used for Quartersawn Oak.
- Glazes and/or Techniques available: F, P, HW, XHW.

Modifications
Are Not
Available

TILE		
TRIAD ROSETTE	ROSETTETRIAD	191

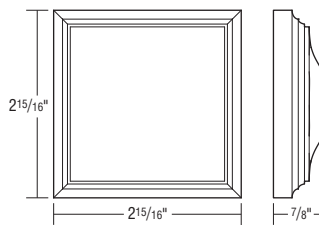

- 2 15/16" x 7/8".
- Alder will be used for Rustic Alder.
- Not available in Quartersawn Oak or Walnut.

Custom Modification Options

FALL
<input checked="" type="checkbox"/>

PINNACLE ROSETTE	ROSETTEPINN	199
------------------	-------------	-----

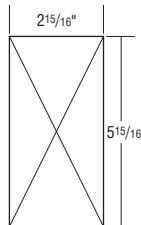

- 5 15/16" x 3/4" x 2 15/16".
- Alder will be used for Rustic Alder.
- Not available in Quartersawn Oak or Walnut.

Custom Modification Options

FALL
<input checked="" type="checkbox"/>

SHELVING		
30" x 30" RUSTIC CORNER SHELF	RSTCCRNHLF	1421

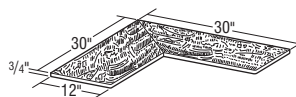

- 30" x 30" x 3/4".
- Brackets sold separately; see Bracket section.
- Alder will be used for Rustic Alder.
- Not available in Quartersawn Oak or Walnut.
- Top and bottom are finished and 4 sides are finished except the back 2 sides. To get all sides finished, please select the Finished All Modification (F.ALL).

Custom Modification Options

FALL
<input checked="" type="checkbox"/>

Glazes and Techniques

- F = Flooded (see page E-4.)
- P = Penned (see page E-4.)
- TW = Timeworn (see page E-4.)
- XTW = Extra Timeworn (see page E-4.)
- HW = Hewn (see page E-4.)
- XHW = Extra Hewn (see page E-4.)

Mouldings & Embellishments

Description	Model	Price
-------------	-------	-------

30" x 30" MODERN CORNER SHELF	MDCCRNHLF	1474
--------------------------------------	------------------	------

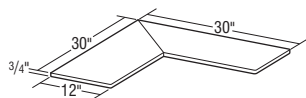

- 30" x 30" x 3/4".
- Brackets sold separately; see Bracket section.
- Alder will be used for Rustic Alder.
- Not available in Quartersawn Oak or Walnut.
- Top and bottom are finished and 4 sides are finished except the back 2 sides. To get all sides finished, please select the Finished All Modification (F.ALL).

Custom Modification Options

F.ALL
✓

30" x 30" RUSTIC FLOATING CORNER SHELF	RSTCFILCRNSHLF	4282
---	-----------------------	------

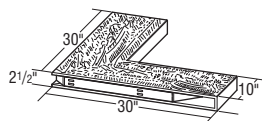

- 30" x 30" x 2 1/2".
- Installation kit included with shelf.
- Maximum weight capacity is 52 lbs.
- Alder will be used for Rustic Alder.
- Not available in Quartersawn Oak or Walnut.

Custom Modification Options

F.ALL
✓

30" x 30" MODERN FLOATING CORNER SHELF	MDFLCRNSHLF	4234
---	--------------------	------

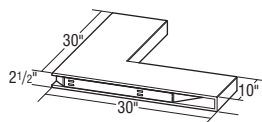

- 30" x 30" x 2 1/2".
- Installation kit included with shelf.
- Maximum weight capacity is 52 lbs.
- 3/4" thick solid-wood front and ends. 3/8" thick veneered top and bottom.
- Alder will be used for Rustic Alder.
- Not available in Quartersawn Oak or Walnut.

Custom Modification Options

F.ALL
✓

36" x 8" INDUSTRIAL SHELF	SHELFIND3681	753
----------------------------------	---------------------	-----

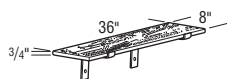

Shown with brackets

- 36" x 8" x 3/4".
- Brackets sold separately; see Corbels and Brackets section.
- Alder will be used for Rustic Alder.
- Oak will be used for Quartersawn Oak.
- Shelf has a rough hewn appearance.
- Top and bottom are finished and 3 sides are finished except the back side. To get all sides finished, please select the Finished All Modification (F.ALL).

Custom Modification Options

F.ALL
✓

36" x 12" INDUSTRIAL SHELF	SHELFIND36121	964
-----------------------------------	----------------------	-----



Shown with brackets

- 36" x 12" x 3/4".
- Brackets sold separately; see Corbels and Brackets section.
- Alder will be used for Rustic Alder.
- Oak will be used for Quartersawn Oak.
- Shelf has a rough hewn appearance.
- Top and bottom are finished and 3 sides are finished except the back side. To get all sides finished, please select the Finished All Modification (F.ALL).

Custom Modification Options

F.ALL
✓

Description	Model	Price
-------------	-------	-------

60" x 8" INDUSTRIAL SHELF	SHELFIND6081	1128
----------------------------------	---------------------	------



Shown with brackets

- 60" x 8" x 3/4".
- Brackets sold separately; see Corbels and Brackets section.
- Alder will be used for Rustic Alder.
- Oak will be used for Quartersawn Oak.
- Shelf has a rough hewn appearance.
- Top and bottom are finished and 3 sides are finished except the back side. To get all sides finished, please select the Finished All Modification (F.ALL).

Custom Modification Options

F.ALL
✓

60" x 12" INDUSTRIAL SHELF	SHELFIND60121	1479
-----------------------------------	----------------------	------

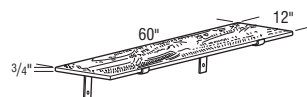

Shown with brackets

- 60" x 12" x 3/4".
- Brackets sold separately; see Corbels and Brackets section.
- Alder will be used for Rustic Alder.
- Oak will be used for Quartersawn Oak.
- Shelf has a rough hewn appearance.
- Top and bottom are finished and 3 sides are finished except the back side. To get all sides finished, please select the Finished All Modification (F.ALL).

Custom Modification Options

F.ALL
✓

24" x 10" FLOATING SHELF	SHELFIND24103	2246
---------------------------------	----------------------	------



- 24" x 10" x 2 5/8".
- Installation kit included with shelf.
- Alder will be used for Rustic Alder.
- Oak will be used for Quartersawn Oak.
- Shelf has a rough hewn appearance.

Custom Modification Options

F.ALL
✓

36" x 10" FLOATING SHELF	SHELFIND36103	2551
---------------------------------	----------------------	------



- 36" x 10" x 2 5/8".
- Installation kit included with shelf.
- Alder will be used for Rustic Alder.
- Oak will be used for Quartersawn Oak.
- Shelf has a rough hewn appearance.

Custom Modification Options

F.ALL
✓

FLOATING SHELF, 2 1/2" HIGH, 10" DEEP	FS24	659
--	-------------	-----

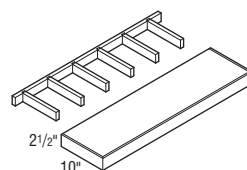

FS30	748
FS36	839
FS42	929
FS48	1017
FS54	1108
FS60	1198

- Shelf is finished on all sides except the back edges.
- Installation instructions included.
- Weight capacity is 15 lbs. per linear foot of width.
- Edge will be a #12 profile.

Custom Modification Options

ID	IW ¹	RD
✓	✓	✓

¹ Not available on 60" wide.

Description	Model	Price
SHELF SUPPORTS		

LARGE GRAPE SHELF SUPPORT

LGGRPSUPPORT 1233

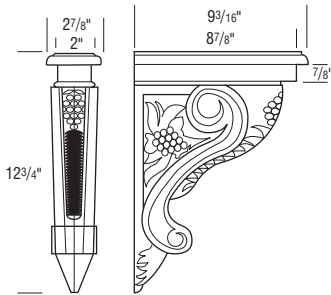

- 2 7/8" wide x 12 3/4" high.
- Not available in Alder, Rustic Alder, or Walnut.
- Oak will be used for Quartersawn Oak.
- Glazes and/or Techniques available: F, P, TW, XTW, HW, XHW.

Modifications
Are Not
Available

SMALL GRAPE SHELF SUPPORT

SMGRPSUPPORT 1037

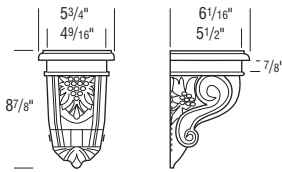

- 5 3/4" wide x 8 7/8" high.
- Not available in Alder, Rustic Alder, or Walnut.
- Oak will be used for Quartersawn Oak.
- Glazes and/or Techniques available: F, P, TW, XTW, HW, XHW.

Modifications
Are Not
Available

LARGE SHELF SUPPORT

LGCORBEL 872

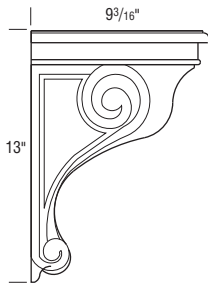

- 2 7/8" wide x 13" high.
- Alder will be used for Rustic Alder.
- Oak will be used for Quartersawn Oak.
- Not available in Walnut.
- Glazes and/or Techniques available: F, P, TW, XTW, HW, XHW.

Modifications
Are Not
Available

SMALL SHELF SUPPORT

SMCORBEL 1166

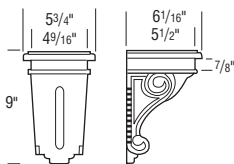

- 5 3/4" wide x 9" high.
- Alder will be used for Rustic Alder.
- Oak will be used for Quartersawn Oak.
- Not available in Walnut.
- Glazes and/or Techniques available: F, P, TW, XTW, HW, XHW.

Modifications
Are Not
Available

COUNTERTOP SUPPORT

SBS 207

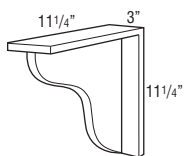

- 3" wide x 11 1/4" high.
- Alder will be used for Rustic Alder.
- Not available in Walnut.
- Glazes and/or Techniques available: F, P, TW, XTW, HW, XHW.

Modifications
Are Not
Available

Description	Model	Price
VICTORIAN COUNTERTOP SUPPORT	VSBS	207

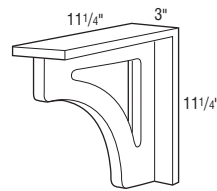

- 3" wide x 11 1/4" high.
- Alder will be used for Rustic Alder.
- Not available in Walnut.
- Glazes and/or Techniques available: F, P, TW, XTW, HW, XHW.

Modifications
Are Not
Available

CORBELS & BRACKETS

12 3/4" MID-CENTURY BRACKET

TRIBRKT12GMG 637

TRIBRKT12SN 637

TRIBRKT12WI 637

TRIBRKT12SS 741

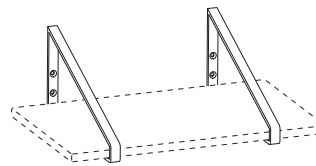
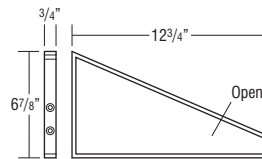

- 12 3/4" x 3/4" x 6 7/8".
- Finishes available: Gun Metal Gray (GMG), Satin Nickel (SN), Wrought Iron (WI), and Stainless Steel (SS).
- Includes matching hardware.
- Pre-drilled mounting holes for easy installation.
- Designed for a 12" deep, 3/4" thick shelf to be placed inside bracket.
- 1/4" material thickness.
- Not intended for cabinet or freestanding countertop support. For substantial weight support, use a floor mounted support such as a Decorative Leg.
- Must be properly installed into a structural member of the wall.
- Sold individually. Recommended to use two brackets on shelves up to 48" wide, additional brackets should be added on wider shelves. If used with the 30" x 30" Corner Shelves, four brackets are recommended.

Modifications
Are Not
Available

8 7/8" INDUSTRIAL BRACKET, LOOP

BRACKETIND9SS 1272

BRACKETIND9GMG 1127

BRACKETIND9WI 1057

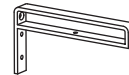
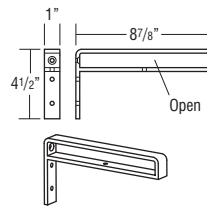

- 1" x 8 7/8" x 4 1/2".
- On the stainless steel versions, the screws are countersunk.
- Finishes available: Stainless Steel (SS), Gun Metal Gray (GMG), and Wrought Iron (WI).
- Open area for 8" deep shelf placement is 15/16" high, shelf is to be secured with a screw in the bottom loop.
- Pre-drilled mounting holes for easy installation.
- 1/4" material thickness.
- Must be properly installed into a structural member of the wall.
- Sold individually. Recommended to use two brackets on shelves up to 48" wide, additional brackets should be added on wider shelves.

Modifications
Are Not
Available

Glazes and Techniques

- F** = Flooded (see page E•4.)
- P** = Penned (see page E•4.)
- TW** = Timeworn (see page E•4.)
- XTW** = Extra Timeworn (see page E•4.)
- HW** = Hewn (see page E•4.)
- XHW** = Extra Hewn (see page E•4.)

Mouldings & Embellishments

Description	Model	Price
12 7/8" INDUSTRIAL BRACKET, LOOP	BRACKETIND13SS	1475
	BRACKETIND13GMG	1302
	BRACKETIND13WI	1302

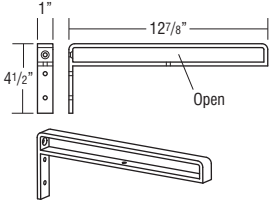

- 1" x 12 7/8" x 4 1/2".
- On the stainless steel versions, the screws are countersunk.
- Finishes available: Stainless Steel (SS), Gun Metal Gray (GMG), and Wrought Iron (WI).
- Open area for 12" deep shelf placement is 15/16" high, shelf is to be secured with a screw in the bottom loop.
- Pre-drilled mounting holes for easy installation.
- 1/4" material thickness.
- Must be properly installed into a structural member of the wall.
- Sold individually. Recommended to use two brackets on shelves up to 48" wide, additional brackets should be added on wider shelves.

Modifications
Are Not
Available

8 1/2" INDUSTRIAL BRACKET, STRAIGHT	STBRACKETIND9SS	1041
	STBRACKETIND9G	789
	STBRACKETIND9WI	789

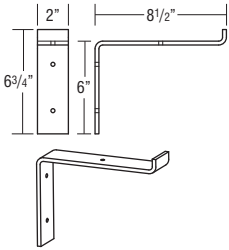

- 2" x 8 1/2" x 6".
- On the stainless steel versions, the screws are countersunk.
- Finishes available: Stainless Steel (SS), Gun Metal Gray (G), and Wrought Iron (WI).

Modifications
Are Not
Available

12 1/2" INDUSTRIAL BRACKET, STRAIGHT	STBRACKETIND13S	1122
	STBRACKETIND13G	904
	STBRACKETIND13W	904

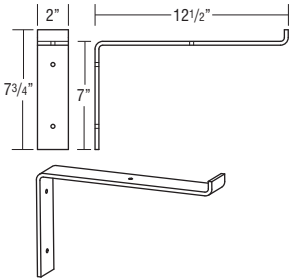

- 2" x 12 1/2" x 7".
- On the stainless steel versions, the screws are countersunk.
- Finishes available: Stainless Steel (S), Gun Metal Gray (G), and Wrought Iron (W).

Modifications
Are Not
Available

10" LEXINGTON SHELF STRAP	LEXSHLFSTRP1OWI	367
	LEXSHLFSTRP1OGM	367
	LEXSHLFSTRP1OSN	367

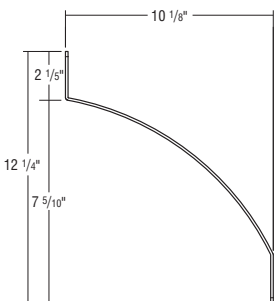

- 10 1/8" x 3" x 12 1/4".
- Finishes available: Gun Metal Gray (GM), Satin Nickel (SN), and Wrought Iron (WI).
- Includes matching hardware.



Modifications
Are Not
Available

Description	Model	Price
2" CORNER STRAP	APEXSTRP2GMG	217
	APEXSTRP2WI	217
	APEXSTRP2SN	217

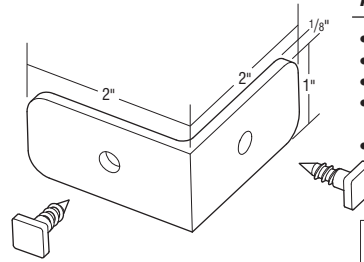

- 1/8" x 2" x 1".
- Decorative only.
- Square Lag Bolts included.
- Finishes available: Gun Metal Gray (GMG), Satin Nickel (SN), and Wrought Iron (WI).
- To be used with floating shelves

Modifications
Are Not
Available

BAROQUE BRACKET	BRACKETBAROQUE	301
------------------------	-----------------------	-----

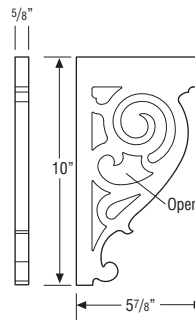

- 5/8" x 5 7/8" x 10".
- Alder will be used for Rustic Alder.
- Not available in Quartersawn Oak or Walnut.

Modifications
Are Not
Available

CELTIC BRACKET	BRACKETCELTIC	383
-----------------------	----------------------	-----

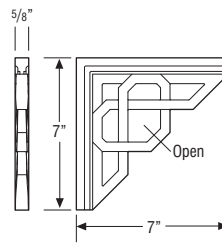

- 5/8" x 7" x 7".
- Alder will be used for Rustic Alder.
- Not available in Quartersawn Oak or Walnut.

Modifications
Are Not
Available

OLD WORLD BRACKET	BRACKETOWD	653
--------------------------	-------------------	-----

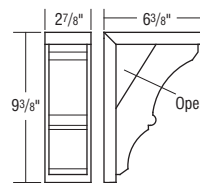

- 2 7/8" wide x 9 3/8" high.
- Alder will be used for Rustic Alder.
- Not available in Walnut.
- Glazes and/or Techniques available: F, P, TW, XTW, HW, XHW.

Custom Modification Options



CRAFTSMAN CORBEL OPEN	CORBELCRAFTO	817
------------------------------	---------------------	-----

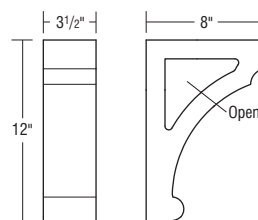

- 3 1/2" x 8" x 12".
- Alder will be used for Rustic Alder.
- Not available in Walnut.

Custom Modification Options

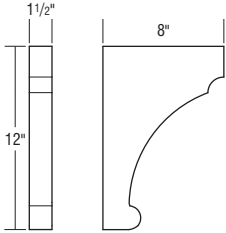

Mouldings & Embellishments

Description	Model	Price		
CRAFTSMAN CORBEL	CORBELCRAFT	362		
	<ul style="list-style-type: none"> • 1 1/2" x 8" x 12" • Alder will be used for Rustic Alder. • Not available in Walnut. 	<p>Custom Modification Options</p> <table border="1"> <tr> <td>F.ALL</td> </tr> <tr> <td>✓</td> </tr> </table>	F.ALL	✓
F.ALL				
✓				

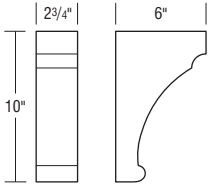
10" CRAFTSMAN CORBEL	CORBELCRAFT10	550		
	<ul style="list-style-type: none"> • 2 3/4" x 6" x 10" • Alder will be used for Rustic Alder. • Not available in Walnut. 	<p>Custom Modification Options</p> <table border="1"> <tr> <td>F.ALL</td> </tr> <tr> <td>✓</td> </tr> </table>	F.ALL	✓
F.ALL				
✓				

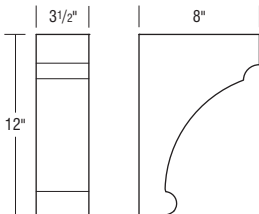
12" CRAFTSMAN CORBEL	CORBELCRAFT12	806		
	<ul style="list-style-type: none"> • 3 1/2" x 8" x 12" • Alder will be used for Rustic Alder. • Not available in Walnut. 	<p>Custom Modification Options</p> <table border="1"> <tr> <td>F.ALL</td> </tr> <tr> <td>✓</td> </tr> </table>	F.ALL	✓
F.ALL				
✓				

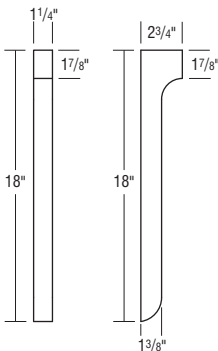
18" CRAFTSMAN CORBEL	CORBELCRAFT18	884		
	<ul style="list-style-type: none"> • 1 1/4" x 2 3/4" x 18" • Alder will be used for Rustic Alder. • Not available in Quartersawn Oak or Walnut. 	<p>Custom Modification Options</p> <table border="1"> <tr> <td>F.ALL</td> </tr> <tr> <td>✓</td> </tr> </table>	F.ALL	✓
F.ALL				
✓				

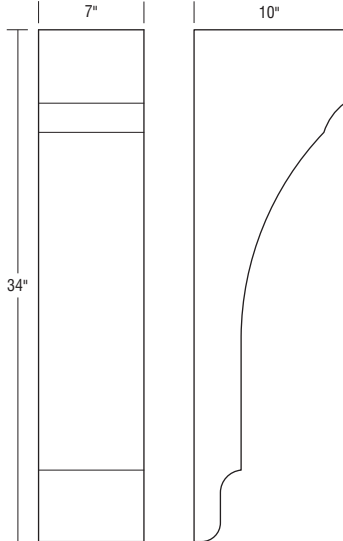
Description	Model	Price		
34" CRAFTSMAN CORBEL	CORBELCRAFT34	3620		
	<ul style="list-style-type: none"> • 7" x 10" x 34" • Alder will be used for Rustic Alder. • Not available in Quartersawn Oak or Walnut. 	<p>Custom Modification Options</p> <table border="1"> <tr> <td>F.ALL</td> </tr> <tr> <td>✓</td> </tr> </table>	F.ALL	✓
F.ALL				
✓				

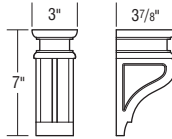
7" PALLADIAN CORBEL	CORBELPALLA7	637		
	<ul style="list-style-type: none"> • 3" x 3 7/8" x 7" • Alder will be used for Rustic Alder. • Not available in Quartersawn Oak or Walnut. 	<p>Custom Modification Options</p> <table border="1"> <tr> <td>F.ALL</td> </tr> <tr> <td>✓</td> </tr> </table>	F.ALL	✓
F.ALL				
✓				

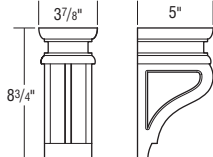
9" PALLADIAN CORBEL	CORBELPALLA9	850		
	<ul style="list-style-type: none"> • 3 7/8" x 5" x 8 3/4" • Alder will be used for Rustic Alder. • Not available in Quartersawn Oak or Walnut. 	<p>Custom Modification Options</p> <table border="1"> <tr> <td>F.ALL</td> </tr> <tr> <td>✓</td> </tr> </table>	F.ALL	✓
F.ALL				
✓				

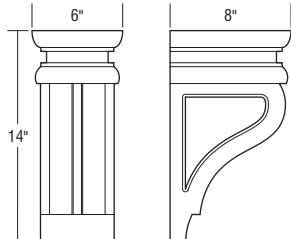
14" PALLADIAN CORBEL	CORBELPALLA14	1509		
	<ul style="list-style-type: none"> • 6" x 8" x 14" • Alder will be used for Rustic Alder. • Not available in Quartersawn Oak or Walnut. 	<p>Custom Modification Options</p> <table border="1"> <tr> <td>F.ALL</td> </tr> <tr> <td>✓</td> </tr> </table>	F.ALL	✓
F.ALL				
✓				

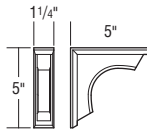
5" CLASSIC REVIVAL CORBEL	CORBELCREV5	342		
	<ul style="list-style-type: none"> • 1 1/4" x 5" x 5" • Alder will be used for Rustic Alder. • Not available in Quartersawn Oak or Walnut. 	<p>Custom Modification Options</p> <table border="1"> <tr> <td>F.ALL</td> </tr> <tr> <td>✓</td> </tr> </table>	F.ALL	✓
F.ALL				
✓				

Mouldings & Embellishments

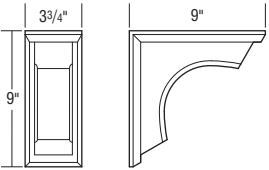
Description	Model	Price
9" CLASSIC REVIVAL CORBEL	CORBELCLREV9	563
	<ul style="list-style-type: none"> • 3 3/4" x 9" x 9" • Alder will be used for Rustic Alder. • Not available in Quartersawn Oak or Walnut. 	Custom Modification Options <input type="checkbox"/> F,ALL <input checked="" type="checkbox"/>

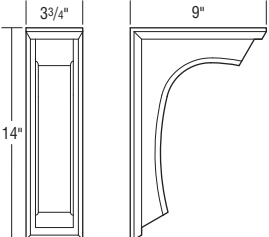
14" CLASSIC REVIVAL CORBEL	CORBELCLREV14	698
	<ul style="list-style-type: none"> • 3 3/4" x 9" x 14" • Alder will be used for Rustic Alder. • Not available in Quartersawn Oak or Walnut. 	Custom Modification Options <input type="checkbox"/> F,ALL <input checked="" type="checkbox"/>

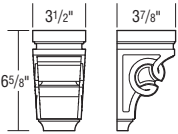
7" CELTIC CORBEL	CORBELCELTIC7	931
	<ul style="list-style-type: none"> • 3 1/2" x 3 7/8" x 6 5/8" • Alder will be used for Rustic Alder. • Not available in Quartersawn Oak or Walnut. 	Custom Modification Options <input type="checkbox"/> F,ALL <input checked="" type="checkbox"/>

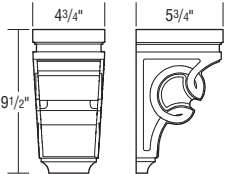
10" CELTIC CORBEL	CORBELCELTIC10	1520
	<ul style="list-style-type: none"> • 4 3/4" x 5 3/4" x 9 1/2" • Alder will be used for Rustic Alder. • Not available in Quartersawn Oak or Walnut. 	Custom Modification Options <input type="checkbox"/> F,ALL <input checked="" type="checkbox"/>

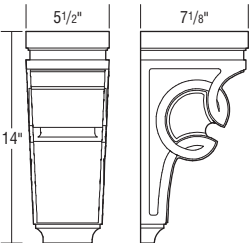
14" CELTIC CORBEL	CORBELCELTIC14	2238
	<ul style="list-style-type: none"> • 5 1/2" x 7 1/8" x 14" • Alder will be used for Rustic Alder. • Not available in Quartersawn Oak or Walnut. 	Custom Modification Options <input type="checkbox"/> F,ALL <input checked="" type="checkbox"/>

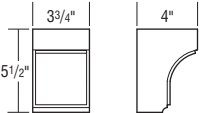
6" TRIAD CORBEL	CORBELTRIAD6	421
	<ul style="list-style-type: none"> • 3 3/4" x 4" x 5 1/2" • Alder will be used for Rustic Alder. • Not available in Quartersawn Oak or Walnut. 	Custom Modification Options <input type="checkbox"/> F,ALL <input checked="" type="checkbox"/>

Glazes and Techniques
 F = Flooded (see page E•4.)
 P = Penned (see page E•4.)
 TW = Timeworn (see page E•4.)
 XTW = Extra Timeworn (see page E•4.)
 HW = Hewn (see page E•4.)
 XHW = Extra Hewn (see page E•4.)

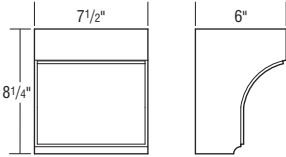
Description	Model	Price
9" TRIAD CORBEL	CORBELTRIAD9	870
	<ul style="list-style-type: none"> • 7 1/2" x 6" x 8 1/4" • Alder will be used for Rustic Alder. • Not available in Quartersawn Oak or Walnut. 	Custom Modification Options <input type="checkbox"/> F,ALL <input checked="" type="checkbox"/>

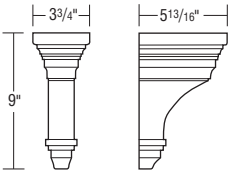
9" ART CORBEL	CORBELART9	775
	<ul style="list-style-type: none"> • 3 3/4" wide x 9" high. • Alder will be used for Rustic Alder. • Not available in Quartersawn Oak or Walnut. • Glazes and/or Techniques available: F, P, TW, XTW, HW, XHW. 	Custom Modification Options <input type="checkbox"/> F,ALL <input checked="" type="checkbox"/>

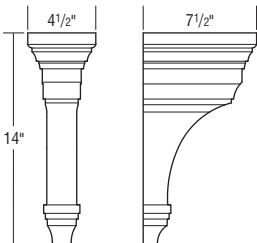
14" ARTS & CRAFTS CORBEL	CORBELART14	1222
	<ul style="list-style-type: none"> • 4 1/2" x 7 1/2" x 14" • Alder will be used for Rustic Alder. • Not available in Quartersawn Oak or Walnut. 	Custom Modification Options <input type="checkbox"/> F,ALL <input checked="" type="checkbox"/>

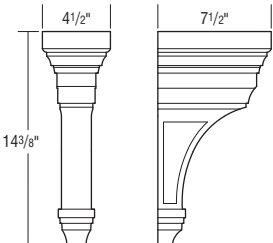
ARTS & CRAFTS OPEN CORBEL	CORBELARTO	1224
	<ul style="list-style-type: none"> • 4 1/2" x 7 1/2" x 14" • Alder will be used for Rustic Alder. • Not available in Quartersawn Oak or Walnut. 	Custom Modification Options <input type="checkbox"/> F,ALL <input checked="" type="checkbox"/>

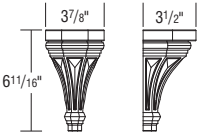
7" PINNACLE CORBEL	CORBELPINN7	723
	<ul style="list-style-type: none"> • 3 7/8" x 3 1/2" x 6 11/16" • Alder will be used for Rustic Alder. • Not available in Quartersawn Oak or Walnut. 	Custom Modification Options <input type="checkbox"/> F,ALL <input checked="" type="checkbox"/>

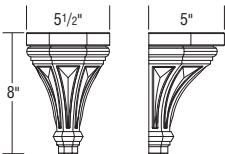
8" PINNACLE CORBEL	CORBELPINN8	1111
	<ul style="list-style-type: none"> • 5 1/2" x 5" x 8" • Alder will be used for Rustic Alder. • Not available in Quartersawn Oak or Walnut. 	Custom Modification Options <input type="checkbox"/> F,ALL <input checked="" type="checkbox"/>

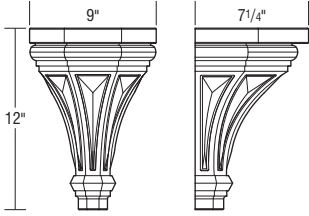
Description	Model	Price		
12" PINNACLE CORBEL	CORBELPINN12	2064		
	<ul style="list-style-type: none"> • 9" x 7 1/4" x 12". • Alder will be used for Rustic Alder. • Not available in Quartersawn Oak or Walnut. 	<p>Custom Modification Options</p> <table border="1"> <tr> <td>F.A.L.L.</td> </tr> <tr> <td>✓</td> </tr> </table>	F.A.L.L.	✓
F.A.L.L.				
✓				

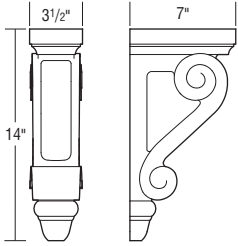
Description	Model	Price		
TRADITIONAL OPEN CORBEL	CORBELTRADO	964		
	<ul style="list-style-type: none"> • 3 1/2" x 7" x 14". • Alder will be used for Rustic Alder. • Not available in Quartersawn Oak or Walnut. 	<p>Custom Modification Options</p> <table border="1"> <tr> <td>F.A.L.L.</td> </tr> <tr> <td>✓</td> </tr> </table>	F.A.L.L.	✓
F.A.L.L.				
✓				

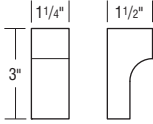
Description	Model	Price		
3" SHAKER CORBEL	CORBELSHKR3	86		
	<ul style="list-style-type: none"> • 1 1/4" x 1 1/2" x 3". • Alder will be used for Rustic Alder. • Not available in Quartersawn Oak or Walnut. 	<p>Custom Modification Options</p> <table border="1"> <tr> <td>F.A.L.L.</td> </tr> <tr> <td>✓</td> </tr> </table>	F.A.L.L.	✓
F.A.L.L.				
✓				

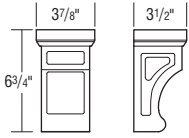
Description	Model	Price		
7" SHAKER CORBEL	CORBELSHKR7	622		
	<ul style="list-style-type: none"> • 3 7/8" x 3 1/2" x 6 3/4". • Alder will be used for Rustic Alder. • Not available in Walnut. 	<p>Custom Modification Options</p> <table border="1"> <tr> <td>F.A.L.L.</td> </tr> <tr> <td>✓</td> </tr> </table>	F.A.L.L.	✓
F.A.L.L.				
✓				

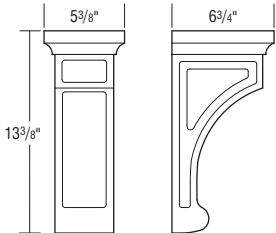
Description	Model	Price		
14" SHAKER CORBEL	CORBELSHKR14	1179		
	<ul style="list-style-type: none"> • 5 3/8" x 6 3/4" x 13 3/8". • Alder will be used for Rustic Alder. • Not available in Walnut. 	<p>Custom Modification Options</p> <table border="1"> <tr> <td>F.A.L.L.</td> </tr> <tr> <td>✓</td> </tr> </table>	F.A.L.L.	✓
F.A.L.L.				
✓				

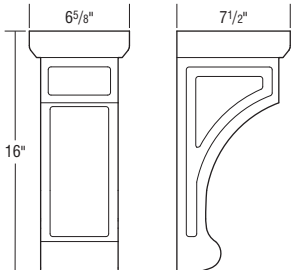
Description	Model	Price		
16" SHAKER CORBEL	CORBELSHKR16	1710		
	<ul style="list-style-type: none"> • 6 5/8" x 7 1/2" x 16". • Alder will be used for Rustic Alder. • Not available in Walnut. 	<p>Custom Modification Options</p> <table border="1"> <tr> <td>F.A.L.L.</td> </tr> <tr> <td>✓</td> </tr> </table>	F.A.L.L.	✓
F.A.L.L.				
✓				

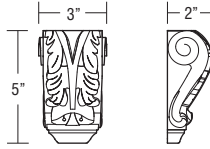
Description	Model	Price		
5" PETITE ACANTHUS CORBEL	CORBELACAN5	433		
	<ul style="list-style-type: none"> • 3" x 2" x 5". • Alder will be used for Rustic Alder. • Not available in Quartersawn Oak or Walnut. 	<p>Custom Modification Options</p> <table border="1"> <tr> <td>F.A.L.L.</td> </tr> <tr> <td>✓</td> </tr> </table>	F.A.L.L.	✓
F.A.L.L.				
✓				

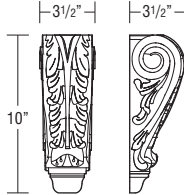
Description	Model	Price		
10" SMALL ACANTHUS CORBEL	CORBELACAN10	867		
	<ul style="list-style-type: none"> • 3 1/2" x 3 1/2" x 10". • Alder will be used for Rustic Alder. • Not available in Quartersawn Oak or Walnut. 	<p>Custom Modification Options</p> <table border="1"> <tr> <td>F.A.L.L.</td> </tr> <tr> <td>✓</td> </tr> </table>	F.A.L.L.	✓
F.A.L.L.				
✓				

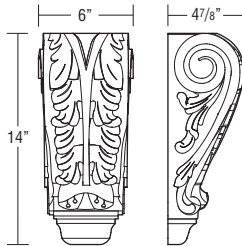
Description	Model	Price		
14" SMALL ACANTHUS CORBEL	CORBELACAN14	1735		
	<ul style="list-style-type: none"> • 6" x 4 7/8" x 14". • Alder will be used for Rustic Alder. • Not available in Quartersawn Oak or Walnut. 	<p>Custom Modification Options</p> <table border="1"> <tr> <td>F.A.L.L.</td> </tr> <tr> <td>✓</td> </tr> </table>	F.A.L.L.	✓
F.A.L.L.				
✓				

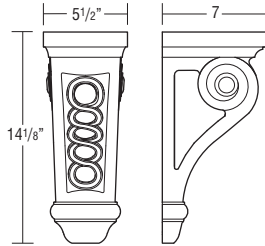
Description	Model	Price		
LARGE BIJOU CORBEL	CORBELBIJL	1369		
	<ul style="list-style-type: none"> • 5 1/2" x 7" x 14 1/8". • Alder will be used for Rustic Alder. • Not available in Quartersawn Oak or Walnut. 	<p>Custom Modification Options</p> <table border="1"> <tr> <td>F.A.L.L.</td> </tr> <tr> <td>✓</td> </tr> </table>	F.A.L.L.	✓
F.A.L.L.				
✓				

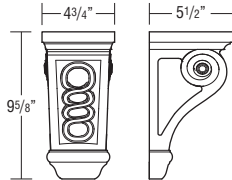
Description	Model	Price		
SMALL BIJOU CORBEL	CORBELBIJS	1055		
	<ul style="list-style-type: none"> • 4 3/4" x 5 1/2" x 9 5/8". • Alder will be used for Rustic Alder. • Not available in Quartersawn Oak or Walnut. 	<p>Custom Modification Options</p> <table border="1"> <tr> <td>F.A.L.L.</td> </tr> <tr> <td>✓</td> </tr> </table>	F.A.L.L.	✓
F.A.L.L.				
✓				

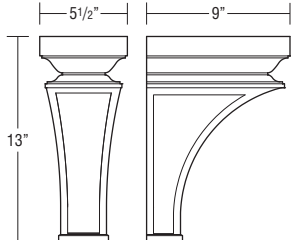
Description	Model	Price		
PLAIN NOUVEAU LARGE CORBEL	CORBELNOUL	1901		
	<ul style="list-style-type: none"> • 5 1/2" x 9" x 13". • Alder will be used for Rustic Alder. • Not available in Quartersawn Oak or Walnut. • Abbey Column Inserts available. See page R•49. 	<p>Custom Modification Options</p> <table border="1"> <tr> <td>F.A.L.L.</td> </tr> <tr> <td>✓</td> </tr> </table>	F.A.L.L.	✓
F.A.L.L.				
✓				

Mouldings & Embellishments

Description	Model	Price
-------------	-------	-------

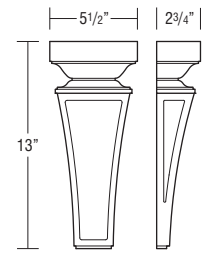

PLAIN NOUVEAU MEDIUM CORBEL	CORBELNOUM	944
------------------------------------	-------------------	-----

- 5 1/2" x 2 3/4" x 13"
- Alder will be used for Rustic Alder.
- Not available in Quartersawn Oak or Walnut.
- Abbey Column Inserts available. See page R•49.

Custom Modification Options
F.A.L.L.
✓

PLAIN NOUVEAU SMALL CORBEL	CORBELNOUS	388
-----------------------------------	-------------------	-----

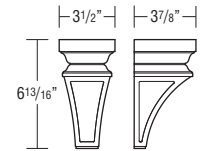

- 3 1/2" x 3 7/8" x 6 13/16"
- Alder will be used for Rustic Alder.
- Not available in Quartersawn Oak or Walnut.
- Abbey Column Inserts available. See page R•49.

Custom Modification Options
F.A.L.L.
✓

LARGE WEAVED CORBEL	CORBELWEAVEL	1560
----------------------------	---------------------	------

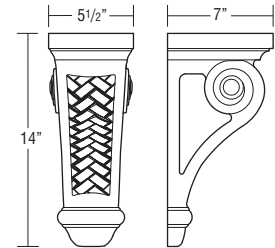

- 5 1/2" x 7" x 14"
- Alder will be used for Rustic Alder.
- Not available in Quartersawn Oak or Walnut.

Custom Modification Options
F.A.L.L.
✓

SMALL WEAVED CORBEL	CORBELWEAVES	779
----------------------------	---------------------	-----

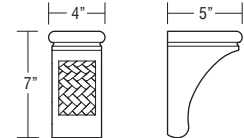

- 4" x 5" x 7"
- Alder will be used for Rustic Alder.
- Not available in Quartersawn Oak or Walnut.

Custom Modification Options
F.A.L.L.
✓

6" MISSION CORBEL	CORBELMIS6	581
--------------------------	-------------------	-----

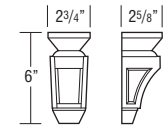

- 2 3/4" wide x 6" high.
- Alder will be used for Rustic Alder.
- Oak will be used for Quartersawn Oak.
- Not available in Walnut.
- Hand-carved.
- Glazes and/or Techniques available: F, P, TW, XTW, HW, XHW.

Custom Modification Options
F.A.L.L.
✓

Glazes and Techniques
F = Flooded (see page E•4.)
P = Penned (see page E•4.)
TW = Timeworn (see page E•4.)
XTW = Extra Timeworn (see page E•4.)
HW = Hewn (see page E•4.)
XHW = Extra Hewn (see page E•4.)

Description	Model	Price
-------------	-------	-------

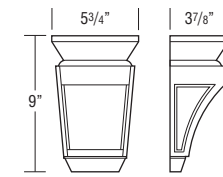

9" MISSION CORBEL	CORBELMIS9	653
--------------------------	-------------------	-----

- 5 3/4" wide x 9" high.
- Alder will be used for Rustic Alder.
- Oak will be used for Quartersawn Oak.
- Not available in Walnut.
- Hand-carved.
- Glazes and/or Techniques available: F, P, TW, XTW, HW, XHW.

Custom Modification Options
F.A.L.L.
✓

OLD WORLD CORBEL	CORBELOWD5	581
-------------------------	-------------------	-----

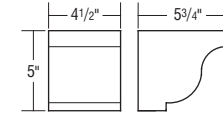

- 4 1/2" wide x 5" high.
- Alder will be used for Rustic Alder.
- Not available in Walnut.
- Glazes and/or Techniques available: F, P, TW, XTW, HW, XHW.

Custom Modification Options
F.A.L.L.
✓

OLD WORLD CORBEL with STRAP	CORBELOWDSTR5	678
------------------------------------	----------------------	-----

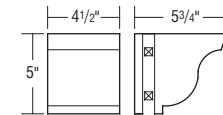

- 4 1/2" wide x 5" high.
- Alder will be used for Rustic Alder.
- Not available in Walnut.
- Hammered iron finish strap.
- Glazes and/or Techniques available: F, P, TW, XTW, HW, XHW.

Custom Modification Options
F.A.L.L.
✓

ABBEY CORBEL INSERT - LARGE	ABBEYCORINSLWI	439
------------------------------------	-----------------------	-----

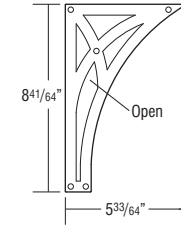

- Wrought Iron
- 1/8" x 5 33/64" x 8 41/64"
- Must be used as an insert for Plain Nouveau Large Corbel (CORBELNOUL).

Custom Modification Options
F.A.L.L.
✓

ABBEY CORBEL INSERT - MEDIUM	ABBEYCORINSMWI	424
-------------------------------------	-----------------------	-----

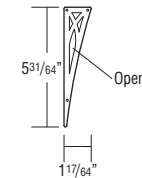

- Wrought Iron
- 1/8" x 1 17/64" x 5 31/64"
- Must be used as an insert for Plain Nouveau Medium Corbel (CORBELNOUM).

Custom Modification Options
F.A.L.L.
✓

ABBEY CORBEL INSERT - SMALL	ABBEYCORINSSWI	411
------------------------------------	-----------------------	-----

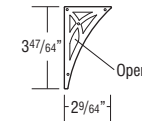

- Wrought Iron
- 1/8" x 2 9/64" x 3 47/64"
- Must be used as an insert for Plain Nouveau Small Corbel (CORBELNOUS).

Custom Modification Options
F.A.L.L.
✓

Description	Model	Price
-------------	-------	-------

FEET

BUNN FOOT

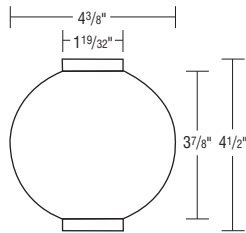

RDBUNNFOOT

381

- 4 3/8" wide x 4 1/2" high.
- Alder will be used for Rustic Alder.
- Not available in Quartersawn Oak or Walnut.
- Glazes and/or Techniques available: F, P, HW, XHW.

Custom Modification Options

F.A.L.L.
<input checked="" type="checkbox"/>

CLASSIC BUN FOOT

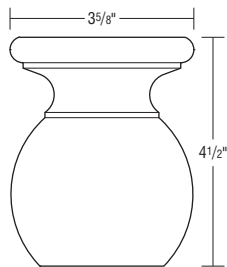

CLBUNNFOOT

197

- 3 5/8" x 3 5/8" x 4 1/2".
- Alder will be used for Rustic Alder.
- Not available in Quartersawn Oak or Walnut.

Custom Modification Options

F.A.L.L.
<input checked="" type="checkbox"/>

LILLE FOOT

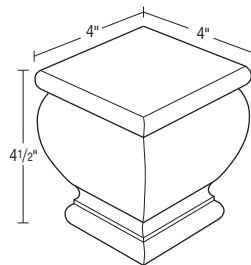

LIFOOT

445

- 4" wide x 4 1/2" high.
- Alder will be used for Rustic Alder.
- Not available in Quartersawn Oak or Walnut.
- Glazes and/or Techniques available: F, P, TW, XTW, HW, XHW.

Custom Modification Options

F.A.L.L.
<input checked="" type="checkbox"/>

LILLE FLUTED FOOT

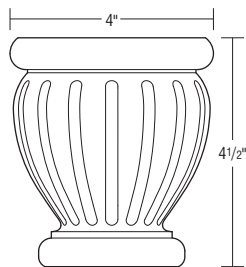

LIFLUTFOOT

210

- 4" x 4 1/2" x 4 1/2".
- Alder will be used for Rustic Alder.
- Not available in Quartersawn Oak or Walnut.

Custom Modification Options

F.A.L.L.
<input checked="" type="checkbox"/>

TULIP FOOT

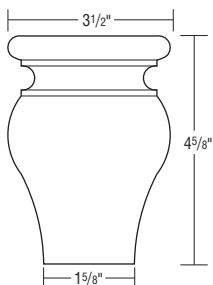

TLFOOT

381

- 3 1/2" wide x 4 5/8" high.
- Only available in Cherry and Maple.
- Glazes and/or Techniques available: F, P, HW, XHW.

Custom Modification Options

F.A.L.L.
<input checked="" type="checkbox"/>

Description

TULIP FOOT SQUARE

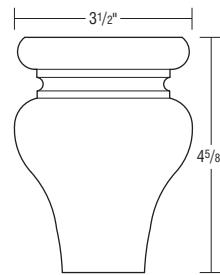

Model

FOOTULIPSQ

Price

175

- 3 1/2" x 3 1/2" x 4 5/8".
- Alder will be used for Rustic Alder.
- Not available in Quartersawn Oak or Walnut.

Custom Modification Options

F.A.L.L.
<input checked="" type="checkbox"/>

TOEKICK TULIP FOOT

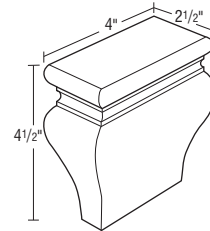

TKTLFOOT

534

- 4" wide x 4 1/2" high.
- Alder will be used for Rustic Alder.
- Not available in Quartersawn Oak or Walnut.
- Glazes and/or Techniques available: F, P, TW, XTW, HW, XHW.

Custom Modification Options

F.A.L.L.
<input checked="" type="checkbox"/>

SQUARE FOOT

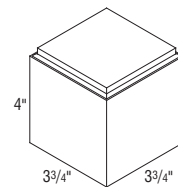

SMSQFOOT

305

- 3 3/4" wide x 4" high x 3 3/4" deep.
- Alder will be used for Rustic Alder.
- Not available in Walnut.
- Glazes and/or Techniques available: F, P, HW, XHW.

Custom Modification Options

F.A.L.L.
<input checked="" type="checkbox"/>

PEDESTAL FOOT - CORNER

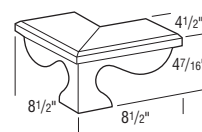

PEDFOOTC

169

- 4 1/2" wide x 4 7/16" high.
- Alder will be used for Rustic Alder.
- Not available in Walnut.
- Glazes and/or Techniques available: F, P, TW, XTW, HW, XHW.

Custom Modification Options

F.A.L.L.
<input checked="" type="checkbox"/>

PEDESTAL FOOT - NO RETURN LEFT

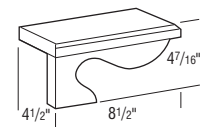

PEDFOOTL

138

- 4 1/2" wide x 4 7/16" high.
- Alder will be used for Rustic Alder.
- Not available in Walnut.
- Glazes and/or Techniques available: F, P, TW, XTW, HW, XHW.

Custom Modification Options

F.A.L.L.
<input checked="" type="checkbox"/>

Glazes and Techniques

- F = Flooded (see page E•4.)
- P = Penned (see page E•4.)
- TW = Timeworn (see page E•4.)
- XTW = Extra Timeworn (see page E•4.)
- HW = Hewn (see page E•4.)
- XHW = Extra Hewn (see page E•4.)

Mouldings & Embellishments

Description	Model	Price
PEDESTAL FOOT - NO RETURN RIGHT	PEDFOOTR	138

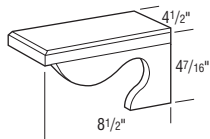

- 4 1/2" wide x 4 7/16" high.
- Alder will be used for Rustic Alder.
- Not available in Walnut.
- Glazes and/or Techniques available: F, P, TW, XTW, HW, XHW.

Custom Modification Options

F.ALL
✓

PEDESTAL FOOT - RETURN LEFT	PEDFOOTRETL	138
------------------------------------	--------------------	-----

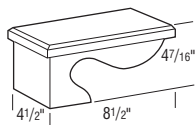

- 4 1/2" wide x 4 7/16" high.
- Alder will be used for Rustic Alder.
- Not available in Walnut.
- Glazes and/or Techniques available: F, P, TW, XTW, HW, XHW.

Custom Modification Options

F.ALL
✓

PEDESTAL FOOT - RETURN RIGHT	PEDFOOTRETR	138
-------------------------------------	--------------------	-----

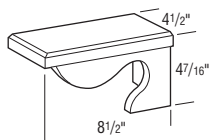

- 4 1/2" wide x 4 7/16" high.
- Alder will be used for Rustic Alder.
- Not available in Walnut.
- Glazes and/or Techniques available: F, P, TW, XTW, HW, XHW.

Custom Modification Options

F.ALL
✓

ACANTHUS FOOT	ACANFOOT	406
----------------------	-----------------	-----

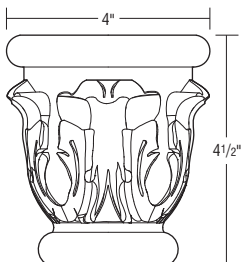

- 4" x 4" x 4 1/2" high.
- Alder will be used for Rustic Alder.
- Not available in Quartersawn Oak or Walnut.

Custom Modification Options

F.ALL
✓

CELTIC FOOT	CELTICFOOT	427
--------------------	-------------------	-----

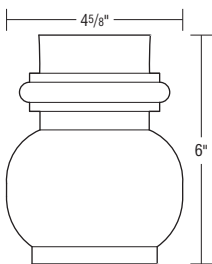

- 4 5/8" x 4 5/8" x 6" high.
- Alder will be used for Rustic Alder.
- Not available in Quartersawn Oak or Walnut.

Custom Modification Options

F.ALL
✓

Glazes and Techniques
 F = Flooded (see page E•4.)
 P = Penned (see page E•4.)
 TW = Timeworn (see page E•4.)
 XTW = Extra Timeworn (see page E•4.)
 HW = Hewn (see page E•4.)
 XHW = Extra Hewn (see page E•4.)

Description	Model	Price
COSMO FOOT	COSFOOT	201

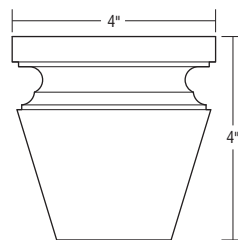

- 4" x 4" x 4" high.
- Alder will be used for Rustic Alder.
- Not available in Quartersawn Oak or Walnut.

Custom Modification Options

F.ALL
✓

TAPERED LEG	TLEG2	137
--------------------	--------------	-----

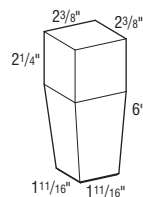

- 2 3/8" x 2 3/8" x 6" high.
- Alder will be used for Rustic Alder.
- Not available in Quartersawn Oak or Walnut.

Custom Modification Options

F.ALL
✓

TAPERED 4-SIDED LEG	T4SLEG	106
----------------------------	---------------	-----

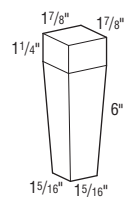

- 1 7/8" x 1 7/8" x 6" high.
- Alder will be used for Rustic Alder.
- Not available in Quartersawn Oak.

Custom Modification Options

F.ALL
✓

TAPERED LEG	TAPLEG	146
--------------------	---------------	-----

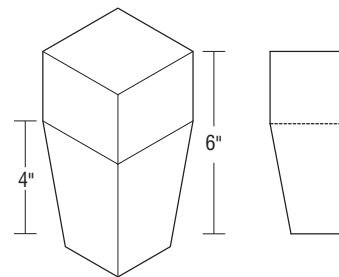

Front View

Side View

- 2 1/2" wide x 6" high.
- Alder will be used for Rustic Alder.
- Not available in Quartersawn Oak.
- Glazes and/or Techniques available: F, HW, XHW.

Custom Modification Options

F.ALL
✓

SUMMIT FOOT	SUMFOOT	251
--------------------	----------------	-----

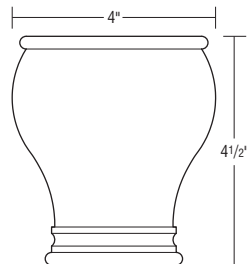

- 4" x 4" x 4 1/2" high.
- Alder will be used for Rustic Alder.
- Not available in Quartersawn Oak or Walnut.

Custom Modification Options

F.ALL
✓

Mouldings & Embellishments

Description	Model	Price
-------------	-------	-------

MADLINE BUN FOOT

MADEFOOT

212

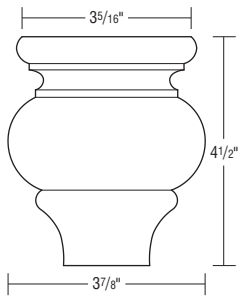

- 3 7/8" x 3 5/16" x 4 1/2".
- Alder will be used for Rustic Alder.
- Not available in Quartersawn Oak or Walnut.

Custom Modification Options

F.ALL
✓

FRENCH COUNTRY FOOT

FRNCNTYFOOT

143

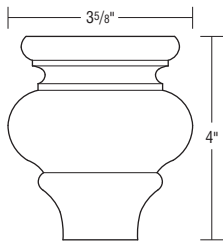

- 3 5/8" x 3 5/8" x 4".
- Alder will be used for Rustic Alder.
- Not available in Quartersawn Oak or Walnut.

Custom Modification Options

F.ALL
✓

HAMPTON PEDESTAL FOOT, CORNER

HAMPPEDFOOTC

346

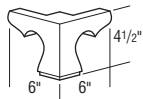

- 4 1/2" x 6" x 6".
- Alder will be used for Rustic Alder.
- Not available in Quartersawn Oak or Walnut.

Custom Modification Options

F.ALL
✓

HAMPTON PEDESTAL FOOT, LEFT

HAMPPEDFOOTL

251

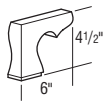

- 4 1/2" x 1 1/2" x 6".
- Alder will be used for Rustic Alder.
- Not available in Quartersawn Oak or Walnut.

Custom Modification Options

F.ALL
✓

HAMPTON PEDESTAL FOOT, RIGHT

HAMPPEDFOOTR

251

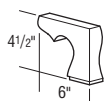

- 4 1/2" x 1 1/2" x 6".
- Alder will be used for Rustic Alder.
- Not available in Quartersawn Oak or Walnut.

Custom Modification Options

F.ALL
✓

Description	Model	Price
-------------	-------	-------

HAMPTON PEDESTAL FOOT, CENTER

HAMPPEDFOOTCTR

183

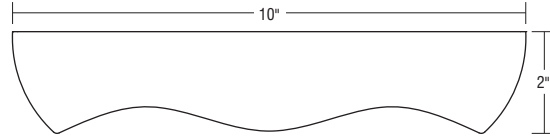

- 2" x 1 1/2" x 10".
- Alder will be used for Rustic Alder.
- Not available in Quartersawn Oak or Walnut.

Custom Modification Options

F.ALL
✓

KENSINGTON FOOT

KENSFOOT

148

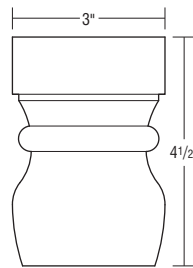

- 3" x 3" x 4 1/2".
- Alder will be used for Rustic Alder.
- Not available in Quartersawn Oak or Walnut.

Custom Modification Options

F.ALL
✓

MADISON FOOT

MADFOOT

180

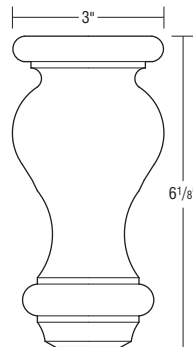

- 3" x 6 1/8".
- Alder will be used for Rustic Alder.
- Not available in Quartersawn Oak or Walnut.

Custom Modification Options

F.ALL
✓

CRAFTSMAN FOOT

CRFTSMNFOOT

187

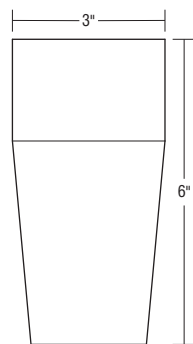

- 3" x 3" x 6".
- Alder will be used for Rustic Alder.
- Not available in Quartersawn Oak.
- Four-sided Tapered Craftsman Foot.

Custom Modification Options

F.ALL
✓

Mouldings & Embellishments

Description	Model	Price
-------------	-------	-------

CRAFTSMAN FOOT, CORNER

CRFTSMNFOOTC

403

- 3 3/4" x 3 3/4" x 6"
- Alder will be used for Rustic Alder.
- Not available in Quartersawn Oak or Walnut.

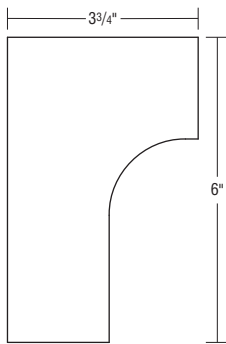

Custom Modification Options

F.A.L.L.
✓

CRAFTSMAN BUN FOOT

CRFTSMNBUNFOOT

212

- 3 5/8" x 4 1/2"
- Alder will be used for Rustic Alder.
- Not available in Quartersawn Oak or Walnut.

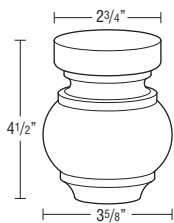

Custom Modification Options

F.A.L.L.
✓

METROPOLITAN FOOT

METROFOOT

322

- 4" x 4" x 4 1/2"
- Alder will be used for Rustic Alder.
- Not available in Quartersawn Oak or Walnut.

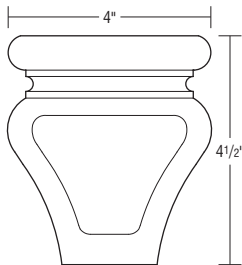

Custom Modification Options

F.A.L.L.
✓

QUEEN ANNE FOOT

QAFOOT

263

- 2 3/4" x 2 3/4" x 8"
- Available in Maple and Cherry only.

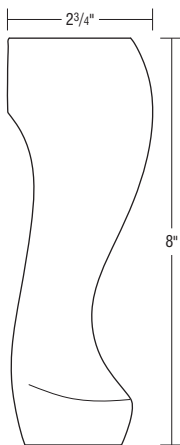

Custom Modification Options

F.A.L.L.
✓

Description	Model	Price
-------------	-------	-------

QUEEN ANNE SCROLL FOOT

QASCROLLFOOT

237

- 3 1/4" x 3 1/4" x 4 1/2"
- Available in Maple and Cherry only.

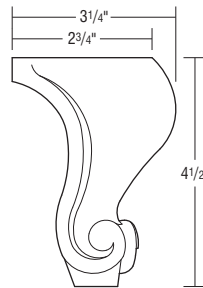

Custom Modification Options

F.A.L.L.
✓

BIJOU BUN FOOT

BIJBUNFOOT

453

- 4" x 4 1/2"
- Alder will be used for Rustic Alder.
- Not available in Quartersawn Oak or Walnut.

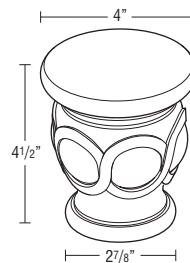

Custom Modification Options

F.A.L.L.
✓

WEAVED BUN FOOT

WEAVEBUNFOOT

411

- 4 7/8" x 4 1/2"
- Alder will be used for Rustic Alder.
- Not available in Quartersawn Oak or Walnut.

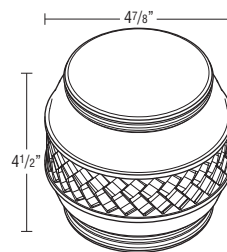

Custom Modification Options

F.A.L.L.
✓

MID-CENTURY FOOT, SHORT

MCFOOTS

289

- 2 1/4" x 4 1/2"
- Alder will be used for Rustic Alder.
- Oak will be used for Quartersawn Oak.
- Not available in Walnut.

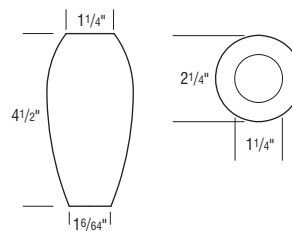

Custom Modification Options

F.A.L.L.
✓

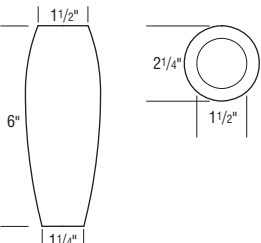
Description	Model	Price		
MID-CENTURY FOOT, MEDIUM	MCFOOTM	314		
	<ul style="list-style-type: none"> • 2 1/4" x 6". • Alder will be used for Rustic Alder. • Oak will be used for Quartersawn Oak. • Not available in Walnut. 	<p>Custom Modification Options</p> <table border="1"> <tr> <td>F.ALL</td> </tr> <tr> <td>✓</td> </tr> </table>	F.ALL	✓
F.ALL				
✓				

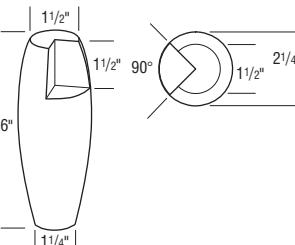
NOTCHED MID-CENTURY FOOT, MEDIUM	NMCFEOTM	544		
	<ul style="list-style-type: none"> • 2 1/4" x 6". • Alder will be used for Rustic Alder. • Oak will be used for Quartersawn Oak. • Not available in Walnut. 	<p>Custom Modification Options</p> <table border="1"> <tr> <td>F.ALL</td> </tr> <tr> <td>✓</td> </tr> </table>	F.ALL	✓
F.ALL				
✓				

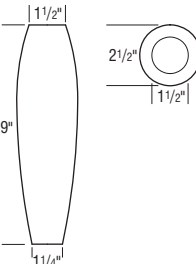
MID-CENTURY FOOT, TALL	MCFOOTT	379		
	<ul style="list-style-type: none"> • 2 1/2" x 9". • Alder will be used for Rustic Alder. • Oak will be used for Quartersawn Oak. • Not available in Walnut. 	<p>Custom Modification Options</p> <table border="1"> <tr> <td>F.ALL</td> </tr> <tr> <td>✓</td> </tr> </table>	F.ALL	✓
F.ALL				
✓				

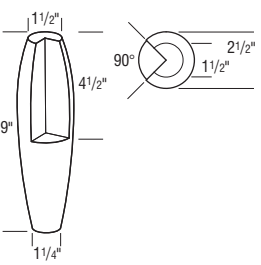
NOTCHED MID-CENTURY FOOT, TALL	NMCFEOTT	688		
	<ul style="list-style-type: none"> • 2 1/2" x 9". • Alder will be used for Rustic Alder. • Oak will be used for Quartersawn Oak. • Not available in Walnut. 	<p>Custom Modification Options</p> <table border="1"> <tr> <td>F.ALL</td> </tr> <tr> <td>✓</td> </tr> </table>	F.ALL	✓
F.ALL				
✓				

Description	Model	Price
6" INDUSTRIAL FOOT	INDFOOT6GMG	1101
	<ul style="list-style-type: none"> • 3" x 3" x 6". • Finishes available: Gun Metal Gray (GMG) and Wrought Iron (WI). 	<p>Modifications Are Not Available</p>

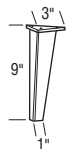
9" INDUSTRIAL FOOT	INDFOOT9GMG	1165
	<ul style="list-style-type: none"> • 3" x 3" x 9". • Finishes available: Gun Metal Gray (GMG) and Wrought Iron (WI). 	<p>Modifications Are Not Available</p>

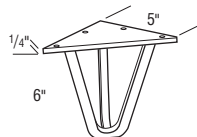
MID-CENTURY METAL FOOT, SHORT	MCMFOOTSGMG	1272
	<ul style="list-style-type: none"> • 5" x 5" x 6". • Finishes available: Gun Metal Gray (GMG) and Wrought Iron (WI). 	<p>Modifications Are Not Available</p>

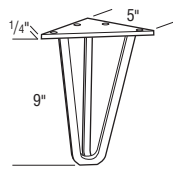
MID-CENTURY METAL FOOT, TALL	MCMFOOTTGMG	1379
	<ul style="list-style-type: none"> • 5" x 5" x 9". • Finishes available: Gun Metal Gray (GMG) and Wrought Iron (WI). 	<p>Modifications Are Not Available</p>

Mouldings & Embellishments

Description	Model	Price
LEGS		

REED LEG

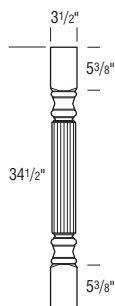

RDLEG	828
--------------	-----

- 3 1/2" diameter x 34 1/2" high.
- Alder will be used for Rustic Alder.
- Oak will be used for Quartersawn Oak.
- Not available in Walnut.
- Glazes and/or Techniques available: F, P, TW, XTW, HW, XHW.

Custom Modification Options

F.ALL	<input checked="" type="checkbox"/>
-------	-------------------------------------

40.5" HIGH REED LEG

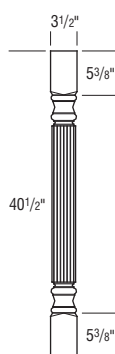

RDLEG40	1068
----------------	------

- 3 1/2" diameter x 40 1/2" high.
- Alder will be used for Rustic Alder.
- Not available in Quartersawn Oak or Walnut.
- Glazes and/or Techniques available: F, P, TW, XTW, HW, XHW.

Custom Modification Options

F.ALL	<input checked="" type="checkbox"/>
-------	-------------------------------------

SPOOL LEG, SMALL

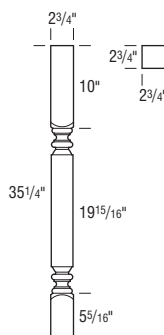

SPLEGS	624
---------------	-----

- 2 3/4" x 2 3/4" x 35 1/4".
- Alder will be used for Rustic Alder.
- Not available in Quartersawn Oak or Walnut.

Custom Modification Options

F.ALL	<input checked="" type="checkbox"/>
-------	-------------------------------------

Glazes and Techniques

F = Flooded (see page E•4.)
 P = Penned (see page E•4.)
 TW = Timeworn (see page E•4.)
 XTW = Extra Timeworn (see page E•4.)
 HW = Hewn (see page E•4.)
 XHW = Extra Hewn (see page E•4.)

Description	Model	Price
SPOOL LEG	SPLEG	828

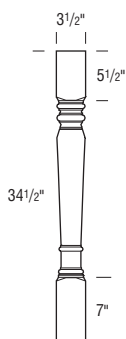

- 3 1/2" wide x 34 1/2" high.
- Alder will be used for Rustic Alder.
- Oak will be used for Quartersawn Oak.
- Not available in Walnut.
- Glazes and/or Techniques available: F, P, TW, XTW, HW, XHW.

Custom Modification Options

F.ALL	<input checked="" type="checkbox"/>
-------	-------------------------------------

40.5" HIGH SPOOL LEG

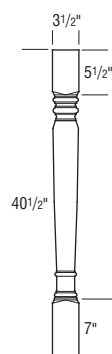

SPLEG40	1068
----------------	------

- 3 1/2" diameter x 40 1/2" high.
- Alder will be used for Rustic Alder.
- Not available in Quartersawn Oak or Walnut.
- Glazes and/or Techniques available: F, P, TW, XTW, HW, XHW.

Custom Modification Options

F.ALL	<input checked="" type="checkbox"/>
-------	-------------------------------------

KITCHEN ISLAND LEG

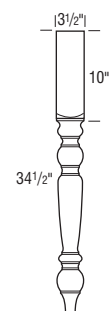

DISLEG	936
---------------	-----

- 3 1/2" wide x 34 1/2" high.
- Alder will be used for Rustic Alder.
- Oak will be used for Quartersawn Oak.
- Not available in Walnut.
- Glazes and/or Techniques available: F, P, TW, XTW, HW, XHW.

Custom Modification Options

F.ALL	<input checked="" type="checkbox"/>
-------	-------------------------------------

FLUTED ISLAND LEG

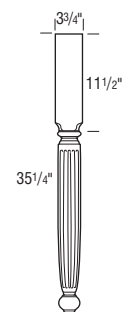

DISLEGFL	994
-----------------	-----

- 3 3/4" wide x 35 1/4" high.
- Alder will be used for Rustic Alder.
- Oak will be used for Quartersawn Oak.
- Not available in Walnut.
- Glazes and/or Techniques available: F, P, TW, XTW, HW, XHW.

Custom Modification Options

F.ALL	<input checked="" type="checkbox"/>
-------	-------------------------------------

Description	Model	Price
SQUARE ISLAND LEG	DISLEGSQ	994

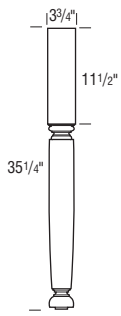

- 3 3/4" wide x 35 1/4" high.
- Alder will be used for Rustic Alder.
- Not available in Walnut.
- Glazes and/or Techniques available: F, P, TW, XTW, HW, XHW.

Custom Modification Options

F.ALL	<input checked="" type="checkbox"/>
-------	-------------------------------------

ROPE ISLAND LEG	DISLEGRP	994
------------------------	-----------------	-----

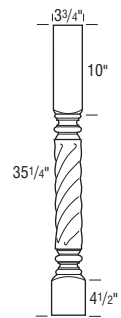

- 3 3/4" wide x 35 1/4" high.
- Alder will be used for Rustic Alder.
- Oak will be used for Quartersawn Oak.
- Not available in Walnut.
- Glazes and/or Techniques available: F, P, TW, XTW, HW, XHW.

Custom Modification Options

F.ALL	<input checked="" type="checkbox"/>
-------	-------------------------------------

MISSION LEG	DLEGMSSION	786
--------------------	-------------------	-----

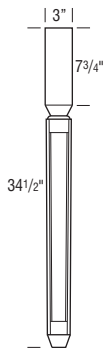

- 3" wide x 34 1/2" high.
- Alder will be used for Rustic Alder.
- Oak will be used for Quartersawn Oak.
- Not available in Walnut.
- Hand-carved.
- Glazes and/or Techniques available: F, P, TW, XTW, HW, XHW.

Custom Modification Options

F.ALL	<input checked="" type="checkbox"/>
-------	-------------------------------------

BAR LEG, 2-SIDED	2SBARLEG	1158
-------------------------	-----------------	------

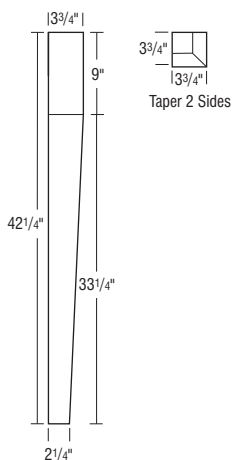

- 3 3/4" wide x 42 1/4" high.
- Alder will be used for Rustic Alder.
- Not available in Quartersawn Oak or Walnut.
- Glazes and/or Techniques available: F, TW, XTW, HW, XHW.

Custom Modification Options

F.ALL	<input checked="" type="checkbox"/>
-------	-------------------------------------

Description	Model	Price
BAR LEG, 4-SIDED	4SBARLEG	1293

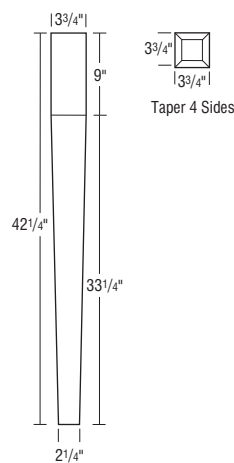

- 3 3/4" wide x 42 1/4" high.
- Alder will be used for Rustic Alder.
- Not available in Quartersawn Oak.
- Glazes and/or Techniques available: F, TW, XTW, HW, XHW.

Custom Modification Options

F.ALL	<input checked="" type="checkbox"/>
-------	-------------------------------------

BAR LEG, SQUARE, 2x2	SQBARLEG2	375
-----------------------------	------------------	-----

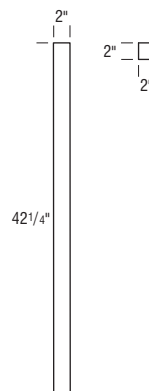

- 2" x 2" x 42 1/4" high.
- Alder will be used for Rustic Alder.
- Not available in Quartersawn Oak.

Custom Modification Options

F.ALL	<input checked="" type="checkbox"/>
-------	-------------------------------------

BAR LEG, SQUARE, 3x3	SQBARLEG3	854
-----------------------------	------------------	-----

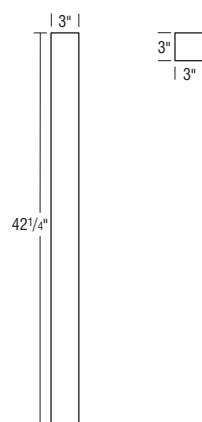

- 3" wide x 3" deep x 42 1/4" high.
- Alder will be used for Rustic Alder.
- Glazes and/or Techniques available: F, TW, XTW, HW, XHW.

Custom Modification Options

F.ALL	<input checked="" type="checkbox"/>
-------	-------------------------------------

Glazes and Techniques

- F = Flooded (see page E•4.)
- P = Penned (see page E•4.)
- TW = Timeworn (see page E•4.)
- XTW = Extra Timeworn (see page E•4.)
- HW = Hewn (see page E•4.)
- XHW = Extra Hewn (see page E•4.)

Mouldings & Embellishments

Description	Model	Price
-------------	-------	-------

BAR LEG, SQUARE, 4x4

SQBARLEG4

984

- 4" wide x 4" deep x 42 1/4" high.
- Alder will be used for Rustic Alder.
- Glazes and/or Techniques available: F, TW, XTW, HW, XHW.

Custom Modification Options

F.A.L.L.
✓

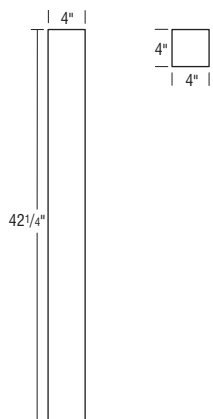

BAR LEG, SQUARE, 5x5

SQBARLEG5

1166

- 5" x 5" x 42 1/4".
- Alder will be used for Rustic Alder.
- Not available in Quartersawn Oak or Walnut.

Custom Modification Options

F.A.L.L.
✓

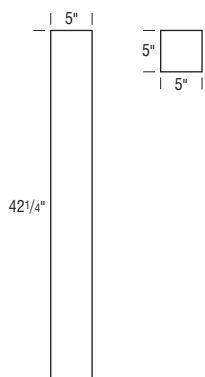

BAR LEG, SQUARE, 6x6

SQBARLEG6

1362

- 6" wide x 6" deep x 42 1/4" high.
- Alder will be used for Rustic Alder.
- Not available in Walnut.
- Glazes and/or Techniques available: F, TW, XTW, HW, XHW.

Custom Modification Options

F.A.L.L.
✓

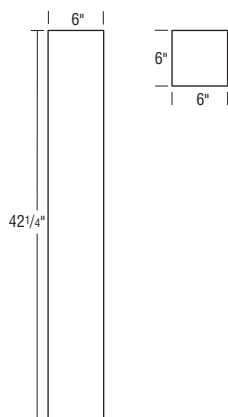

Glazes and Techniques

- F = Flooded (see page E•4.)
- P = Penned (see page E•4.)
- TW = Timeworn (see page E•4.)
- XTW = Extra Timeworn (see page E•4.)
- HW = Hewn (see page E•4.)
- XHW = Extra Hewn (see page E•4.)

Description	Model	Price
-------------	-------	-------

ISLAND LEG, 2-SIDED

2SISLEG

1067

- 3 3/4" wide x 35 1/4" high.
- Alder will be used for Rustic Alder.
- Not available in Quartersawn Oak or Walnut.
- Glazes and/or Techniques available: F, TW, XTW, HW, XHW.

Custom Modification Options

F.A.L.L.
✓

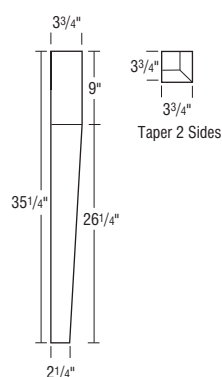

ISLAND LEG, 4-SIDED

4SISLEG

1199

- 3 3/4" wide x 35 1/4" high.
- Alder will be used for Rustic Alder.
- Not available in Quartersawn Oak.
- Glazes and/or Techniques available: F, TW, XTW, HW, XHW.

Custom Modification Options

F.A.L.L.
✓

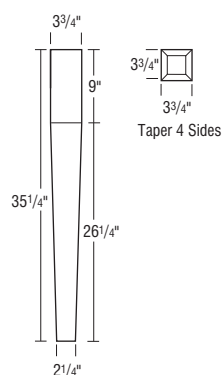

ISLAND LEG, SQUARE, 2x2

SQISLEG2

300

- 2" x 2" x 35 1/4".
- Alder will be used for Rustic Alder.
- Not available in Quartersawn Oak.

Custom Modification Options

F.A.L.L.
✓

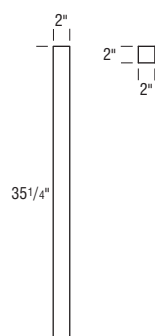

ISLAND LEG, SQUARE, 3x3

SQISLEG3

758

- 3" wide x 3" deep x 35 1/4" high.
- Alder will be used for Rustic Alder.
- Glazes and/or Techniques available: F, TW, XTW, HW, XHW.

Custom Modification Options

F.A.L.L.
✓

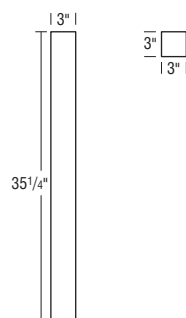

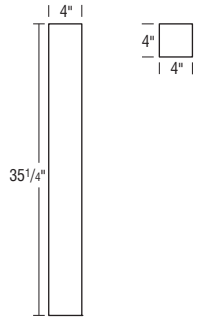
Description	Model	Price		
ISLAND LEG, SQUARE, 4x4	JSQISLEG4	871		
	<ul style="list-style-type: none"> 4" wide x 4" deep x 35 1/4" high. Alder will be used for Rustic Alder. Glazes and/or Techniques available: F, TW, XTW, HW, XHW. 	<p>Custom Modification Options</p> <table border="1"> <tr><td>F.ALL</td></tr> <tr><td>✓</td></tr> </table>	F.ALL	✓
F.ALL				
✓				

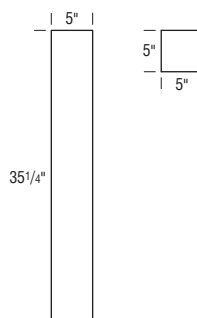
ISLAND LEG, SQUARE, 5x5	SQISLEG5	1111		
	<ul style="list-style-type: none"> 5" x 5" x 35 1/4". Alder will be used for Rustic Alder. Not available in Quartersawn Oak or Walnut. 	<p>Custom Modification Options</p> <table border="1"> <tr><td>F.ALL</td></tr> <tr><td>✓</td></tr> </table>	F.ALL	✓
F.ALL				
✓				

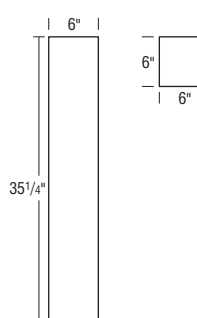
ISLAND LEG, SQUARE, 6x6	JSQISLEG6	1181		
	<ul style="list-style-type: none"> 6" wide x 6" deep x 35 1/4" high. Alder will be used for Rustic Alder. Not available in Walnut. Glazes and/or Techniques available: F, TW, XTW, HW, XHW. 	<p>Custom Modification Options</p> <table border="1"> <tr><td>F.ALL</td></tr> <tr><td>✓</td></tr> </table>	F.ALL	✓
F.ALL				
✓				

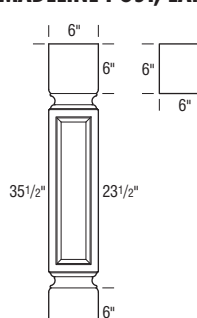
MADLINE POST, LARGE	MADLINEPOSTL	3066		
	<ul style="list-style-type: none"> 6" x 6" x 35 1/2". Alder will be used for Rustic Alder. Not available in Quartersawn Oak or Walnut. 	<p>Custom Modification Options</p> <table border="1"> <tr><td>F.ALL</td></tr> <tr><td>✓</td></tr> </table>	F.ALL	✓
F.ALL				
✓				

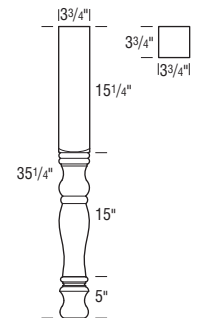
Description	Model	Price		
ENGLISH COUNTRY LEG	ENGNTYLEG	803		
	<ul style="list-style-type: none"> 3 3/4" x 3 3/4" x 35 1/4". Alder will be used for Rustic Alder. Not available in Quartersawn Oak or Walnut. 	<p>Custom Modification Options</p> <table border="1"> <tr><td>F.ALL</td></tr> <tr><td>✓</td></tr> </table>	F.ALL	✓
F.ALL				
✓				

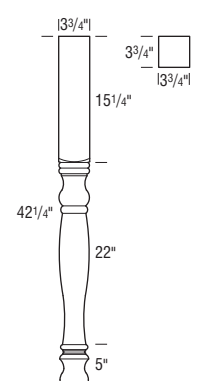
ENGLISH COUNTRY LEG, TALL	ENGNTYLEGT	908		
	<ul style="list-style-type: none"> 3 3/4" x 3 3/4" x 42 1/4". Alder will be used for Rustic Alder. Not available in Quartersawn Oak or Walnut. 	<p>Custom Modification Options</p> <table border="1"> <tr><td>F.ALL</td></tr> <tr><td>✓</td></tr> </table>	F.ALL	✓
F.ALL				
✓				

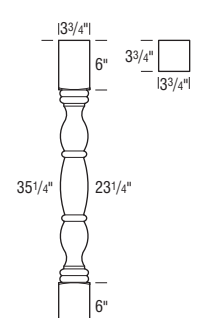
ENGLISH COUNTRY LEG, ISLAND	ENGNTYLEGISL	774		
	<ul style="list-style-type: none"> 3 3/4" x 3 3/4" x 35 1/4". Alder will be used for Rustic Alder. Not available in Quartersawn Oak or Walnut. 	<p>Custom Modification Options</p> <table border="1"> <tr><td>F.ALL</td></tr> <tr><td>✓</td></tr> </table>	F.ALL	✓
F.ALL				
✓				

Glazes and Techniques

F = Flooded (see page E•4.)
P = Penned (see page E•4.)
TW = Timeworn (see page E•4.)
XTW = Extra Timeworn (see page E•4.)
HW = Hewn (see page E•4.)
XHW = Extra Hewn (see page E•4.)

Mouldings & Embellishments

Description	Model	Price
-------------	-------	-------

ESTATE LEG

ESTATELEG

822

- 3 3/4" x 3 3/4" x 35 1/4"
- Alder will be used for Rustic Alder.
- Not available in Quartersawn Oak or Walnut.

Custom Modification Options

F.A.L.L.
✓

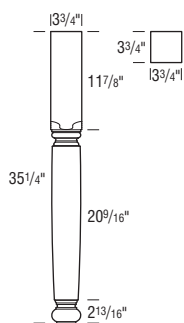

ESTATE LEG, LARGE

ESTATELEGL

1613

- 5" x 5" x 35 1/4"
- Alder will be used for Rustic Alder.
- Not available in Quartersawn Oak or Walnut.

Custom Modification Options

F.A.L.L.
✓

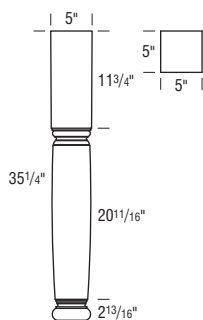

ESTATE LEG, TALL

ESTATELEGT

990

- 3 3/4" x 3 3/4" x 42 1/4"
- Alder will be used for Rustic Alder.
- Not available in Quartersawn Oak or Walnut.

Custom Modification Options

F.A.L.L.
✓

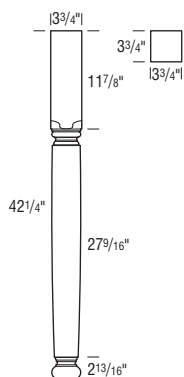

ESTATE FLUTE LEG, TALL

ESTATEFLUTELEG

1127

- 3 3/4" x 3 3/4" x 42 1/4"
- Alder will be used for Rustic Alder.
- Not available in Quartersawn Oak or Walnut.

Custom Modification Options

F.A.L.L.
✓

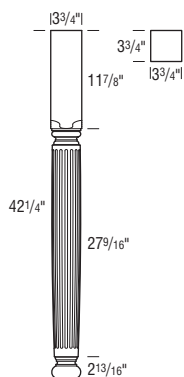

Description	Model	Price
-------------	-------	-------

ESTATE LEG, SQUARE

ESTATELEGS

736

- 2 3/4" x 2 3/4" x 35 1/4"
- Alder will be used for Rustic Alder.
- Not available in Quartersawn Oak or Walnut.

Custom Modification Options

F.A.L.L.
✓

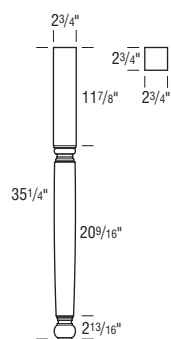

FRENCH COUNTRY LEG, DOUBLE SQUARE

FRNCNTYLEG

865

- 3 3/4" x 3 3/4" x 35 1/4"
- Alder will be used for Rustic Alder.
- Not available in Quartersawn Oak or Walnut.

Custom Modification Options

F.A.L.L.
✓

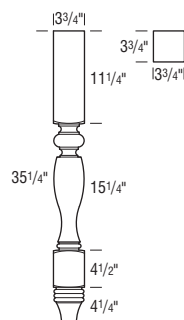

FRENCH COUNTRY LEG, LARGE, DOUBLE SQUARE

FRNCNTYLEGL

1340

- 5" x 5" x 35 1/4"
- Alder will be used for Rustic Alder.
- Not available in Quartersawn Oak or Walnut.

Custom Modification Options

F.A.L.L.
✓

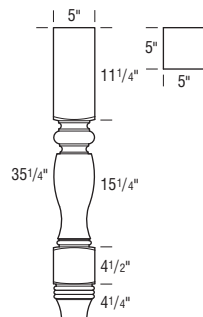

FRENCH COUNTRY LEG, SINGLE SQUARE

FRNCNTYLEG2

892

- 3 3/4" x 3 3/4" x 35 1/4"
- Alder will be used for Rustic Alder.
- Not available in Quartersawn Oak or Walnut.

Custom Modification Options

F.A.L.L.
✓

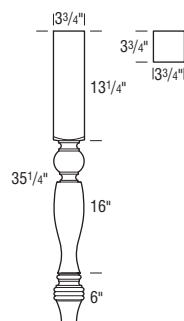

Description	Model	Price
FRENCH COUNTRY LEG, LARGE, SINGLE SQUARE	FRNCNTYLEG2	1486

- 5" x 5" x 35 1/4"
- Alder will be used for Rustic Alder.
- Not available in Quartersawn Oak or Walnut.

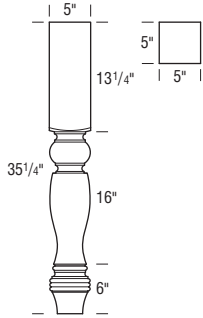

Custom Modification Options
F.ALL
✓

FRENCH COUNTRY REEDED LEG, SINGLE SQUARE	FRNCNTYRDLEG2	950
---	----------------------	-----

- 3 3/4" x 3 3/4" x 35 1/4"
- Alder will be used for Rustic Alder.
- Not available in Quartersawn Oak or Walnut.

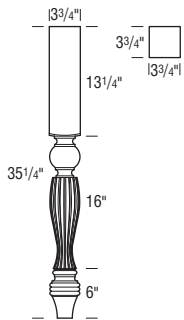

Custom Modification Options
F.ALL
✓

FRENCH COUNTRY SQUARE LEG	FRNCNTYSQLEG	946
----------------------------------	---------------------	-----

- 3 3/4" x 3 3/4" x 35 1/4"
- Alder will be used for Rustic Alder.
- Not available in Quartersawn Oak or Walnut.

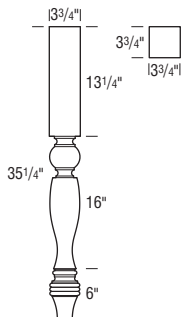

Custom Modification Options
F.ALL
✓

FRENCH COUNTRY SQUARE LEG, ROUTED	FRNCNTYSQLEGR	1630
--	----------------------	------

- 3 3/4" x 3 3/4" x 35 1/4"
- Alder will be used for Rustic Alder.
- Not available in Quartersawn Oak or Walnut.

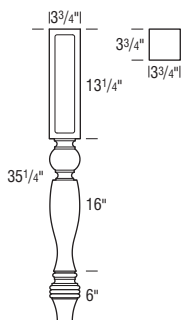

Custom Modification Options
F.ALL
✓

Description	Model	Price
FRENCH COUNTRY LEG, TALL, SINGLE SQUARE	FRNCNTYLEG2T	1015

- 3 3/4" x 3 3/4" x 42 1/4"
- Alder will be used for Rustic Alder.
- Not available in Quartersawn Oak or Walnut.

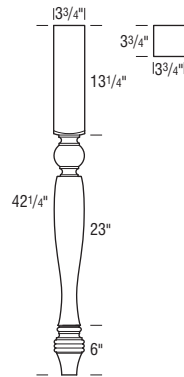

Custom Modification Options
F.ALL
✓

FRENCH COUNTRY REEDED LEG, TALL, SINGLE SQUARE	FRNCNTYRDLEG2T	1150
---	-----------------------	------

- 3 3/4" x 3 3/4" x 42 1/4"
- Alder will be used for Rustic Alder.
- Not available in Quartersawn Oak or Walnut.

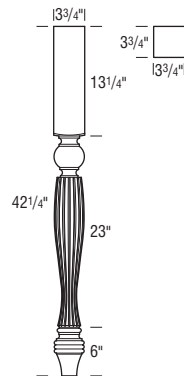

Custom Modification Options
F.ALL
✓

KENSINGTON LEG	KENSINGLEG	622
-----------------------	-------------------	-----

- 1 15/32" x 3" x 35 1/4"
- Alder will be used for Rustic Alder.
- Not available in Quartersawn Oak or Walnut.

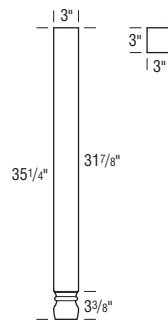

Custom Modification Options
F.ALL
✓

Mouldings & Embellishments

Description	Model	Price
-------------	-------	-------

QUEEN ANNE LEG

FRNLG

208

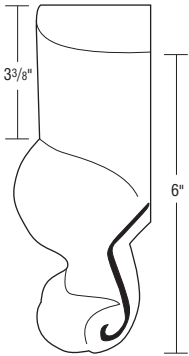

- 2" wide x 6" high.
- Alder will be used for Rustic Alder.
- Not available in Quartersawn Oak or Walnut.
- Glazes and/or Techniques available: F, P, HW, XHW.

Custom Modification Options

F.ALL	<input checked="" type="checkbox"/>
-------	-------------------------------------

QUEEN ANNE CORNER LEG

QACRNLG

705

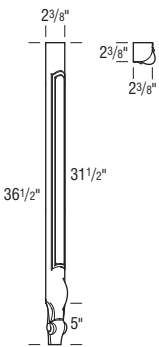

- 2 3/8" x 2 3/8" x 36 1/2".
- Alder will be used for Rustic Alder.
- Not available in Quartersawn Oak or Walnut.

Custom Modification Options

F.ALL	<input checked="" type="checkbox"/>
-------	-------------------------------------

QUEEN ANNE CORNER ACANTHUS LEG

QACRNRACLEG

770

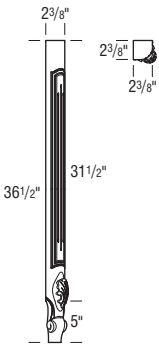

- 2 3/8" x 2 3/8" x 36 1/2".
- Alder will be used for Rustic Alder.
- Not available in Quartersawn Oak or Walnut.

Custom Modification Options

F.ALL	<input checked="" type="checkbox"/>
-------	-------------------------------------

Glazes and Techniques

- F = Flooded (see page E•4.)
- P = Penned (see page E•4.)
- TW = Timeworn (see page E•4.)
- XTW = Extra Timeworn (see page E•4.)
- HW = Hewn (see page E•4.)
- XHW = Extra Hewn (see page E•4.)

Description	Model	Price
-------------	-------	-------

QUEEN ANNE CORNER FLUTED LEG

QACRNRFLUTLEG

702

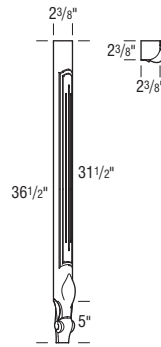

- 2 3/8" x 2 3/8" x 36 1/2".
- Alder will be used for Rustic Alder.
- Not available in Quartersawn Oak or Walnut.

Custom Modification Options

F.ALL	<input checked="" type="checkbox"/>
-------	-------------------------------------

ROPE LEG, SMALL

ROPELEGS

779

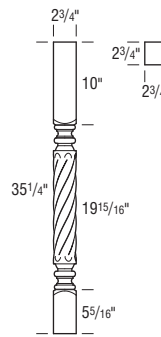

- 2 3/4" x 2 3/4" x 35 1/4".
- Alder will be used for Rustic Alder.
- Not available in Quartersawn Oak or Walnut.

Custom Modification Options

F.ALL	<input checked="" type="checkbox"/>
-------	-------------------------------------

ROPE LEG, LARGE

ROPELEGL

1523

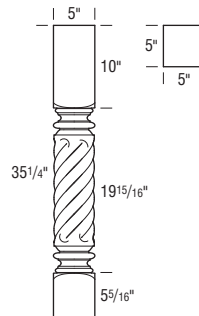

- 5" x 5" x 35 1/4".
- Alder will be used for Rustic Alder.
- Not available in Quartersawn Oak or Walnut.

Custom Modification Options

F.ALL	<input checked="" type="checkbox"/>
-------	-------------------------------------

ROPE LEG, QUARTERED

ROPELEGQTR

483

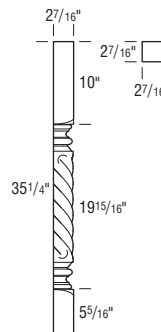

- 2 7/16" x 2 7/16" x 35 1/4".
- Alder will be used for Rustic Alder.
- Not available in Quartersawn Oak or Walnut.

Custom Modification Options

F.ALL	<input checked="" type="checkbox"/>
-------	-------------------------------------

Description	Model	Price
-------------	-------	-------

FLUTE LEG, SMALL

Model	Price
FLUTELEGS	710

- 2 3/4" x 2 3/4" x 35 1/4".
- Alder will be used for Rustic Alder.
- Not available in Quartersawn Oak or Walnut.

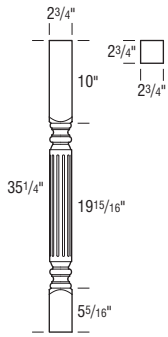

Custom Modification Options

F.ALL
✓

Description	Model	Price
-------------	-------	-------

FLUTE LEG, LARGE

Model	Price
FLUTELEGL	1491

- 5" x 5" x 35 1/4".
- Alder will be used for Rustic Alder.
- Not available in Quartersawn Oak or Walnut.

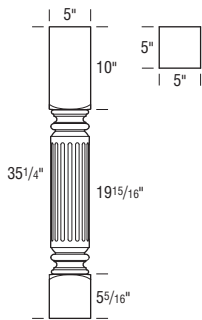

Custom Modification Options

F.ALL
✓

Description	Model	Price
-------------	-------	-------

FLUTE LEG, QUARTERED

Model	Price
FLUTELEGQTR	485

- 2 1/2" x 2 1/2" x 35 1/4".
- Alder will be used for Rustic Alder.
- Not available in Quartersawn Oak or Walnut.

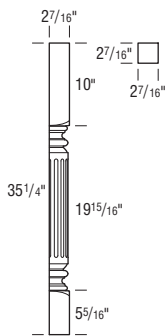

Custom Modification Options

F.ALL
✓

Description	Model	Price
-------------	-------	-------

ACANTHUS LEG, LARGE

Model	Price
ACANTHUSLEGL	2945

- 6" x 6" x 35 1/2".
- Alder will be used for Rustic Alder.
- Not available in Quartersawn Oak or Walnut.

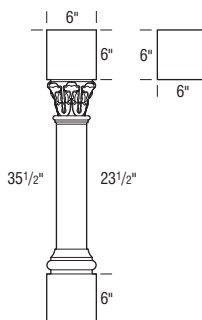

Custom Modification Options

F.ALL
✓

Description	Model	Price
-------------	-------	-------

ACANTHUS LEG

Model	Price
ACANTHUSLEG	1197

- 3 3/4" x 3 3/4" x 35 1/4".
- Alder will be used for Rustic Alder.
- Not available in Quartersawn Oak or Walnut.

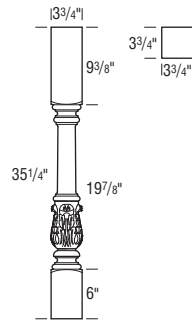

Custom Modification Options

F.ALL
✓

Description	Model	Price
-------------	-------	-------

GAELIC LEG, LARGE

Model	Price
GAELICLEGL	2049

- 6" x 6" x 35 1/2".
- Alder will be used for Rustic Alder.
- Not available in Quartersawn Oak or Walnut.

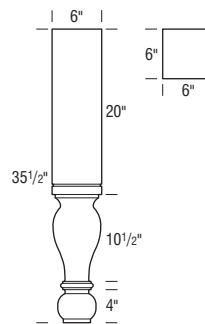

Custom Modification Options

F.ALL
✓

Description	Model	Price
-------------	-------	-------

GAELIC LEG, LARGE, ROUTED

Model	Price
GAELICLEGLR	2957

- 6" x 6" x 35 1/2".
- Alder will be used for Rustic Alder.
- Not available in Quartersawn Oak or Walnut.

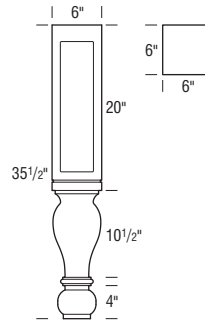

Custom Modification Options

F.ALL
✓

Description	Model	Price
-------------	-------	-------

APEX LEG

Model	Price
APEXLEG	1509

- 3 1/2" x 3 1/2" x 34 1/2".
- Alder will be used for Rustic Alder.
- Not available in Quartersawn Oak or Walnut.

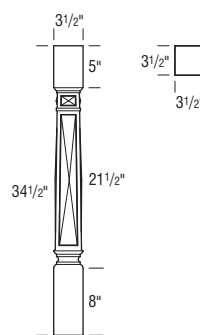

Custom Modification Options

F.ALL
✓

Mouldings & Embellishments

Description	Model	Price
-------------	-------	-------

APEX LEG, TALL

APEXLEG

1682

- 3 1/2" x 3 1/2" x 40 1/2"
- Alder will be used for Rustic Alder.
- Not available in Quartersawn Oak or Walnut.

Custom Modification Options

F.A.L.L.
✓

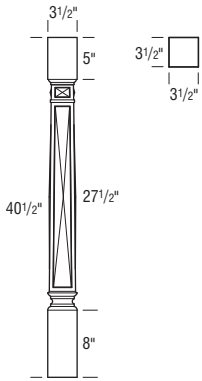

PACIFIC RIM LEG

PRLEG

3298

- 4 7/8" x 29"
- Alder will be used for Rustic Alder.
- Oak will be used for Quartersawn Oak.
- Not available in Walnut.

Custom Modification Options

F.A.L.L.
✓

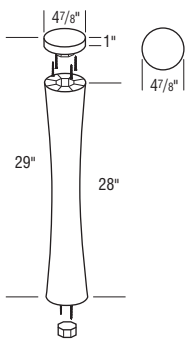

MID-CENTURY TABLE LEG

MCLEG

3321

- 6 1/4" x 29"
- Alder will be used for Rustic Alder.
- Oak will be used for Quartersawn Oak.
- Not available in Walnut.

Custom Modification Options

F.A.L.L.
✓

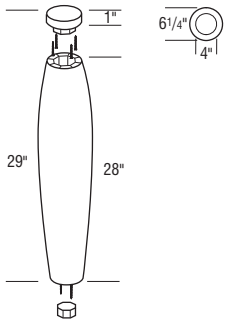

Description	Model	Price
-------------	-------	-------

3" x 35 1/4" SQUARE LEG with SLEEVE

3SLEGALS-35

1390

3SLEGWIS-35

1415

- 3" x 3" x 35 1/4"
- Alder will be used for Rustic Alder.
- Oak will be used for Quartersawn Oak.
- Not available in Walnut.
- Finishes available: Brushed Aluminum Sleeve (ALS) and Wrought Iron Sleeve (WIS).

Custom Modification Options

F.A.L.L.
✓

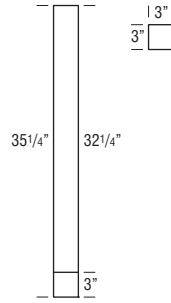

3" x 42 1/2" SQUARE LEG with SLEEVE

3SLEGALS-42

1555

3SLEGWIS-42

1580

- 3" x 3" x 42 1/2"
- Alder will be used for Rustic Alder.
- Oak will be used for Quartersawn Oak.
- Not available in Walnut.
- Finishes available: Brushed Aluminum Sleeve (ALS) and Wrought Iron Sleeve (WIS).

Custom Modification Options

F.A.L.L.
✓

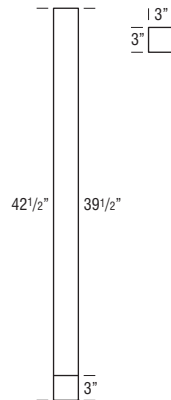

4" x 35 1/4" SQUARE LEG with SLEEVE

4SLEGALS-35

1566

4SLEGWIS-35

1591

- 4" x 4" x 35 1/4"
- Alder will be used for Rustic Alder.
- Oak will be used for Quartersawn Oak.
- Not available in Walnut.
- Finishes available: Brushed Aluminum Sleeve (ALS) and Wrought Iron Sleeve (WIS).

Custom Modification Options

F.A.L.L.
✓

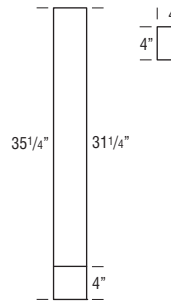

4" x 42 1/2" SQUARE LEG with SLEEVE

4SLEGALS-42

1754

4SLEGWIS-42

1779

- 4" x 4" x 42 1/2"
- Alder will be used for Rustic Alder.
- Oak will be used for Quartersawn Oak.
- Not available in Walnut.
- Finishes available: Brushed Aluminum Sleeve (ALS) and Wrought Iron Sleeve (WIS).

Custom Modification Options

F.A.L.L.
✓

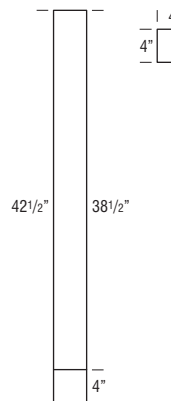

Description	Model	Price
5" x 35 1/4" SQUARE LEG with SLEEVE	5SQLEGALS-35	1861
	5SQLEGWIS-35	1886

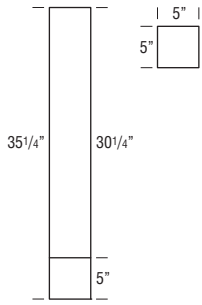

- 5" x 5" x 35 1/4".
- Alder will be used for Rustic Alder.
- Oak will be used for Quartersawn Oak.
- Not available in Walnut.
- Finishes available: Brushed Aluminum Sleeve (ALS) and Wrought Iron Sleeve (WIS).

Custom Modification Options

F.ALL
✓

5" x 42 1/2" SQUARE LEG with SLEEVE	5SQLEGALS-42	1993
	5SQLEGWIS-42	2017

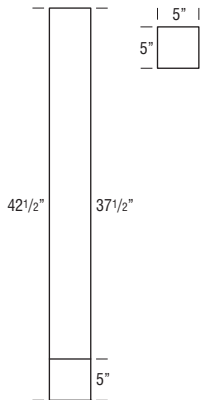

- 5" x 5" x 42 1/2".
- Alder will be used for Rustic Alder.
- Oak will be used for Quartersawn Oak.
- Not available in Walnut.
- Finishes available: Brushed Aluminum Sleeve (ALS) and Wrought Iron Sleeve (WIS).

Custom Modification Options

F.ALL
✓

Description	Model	Price
PEDESTALS & BASES		

4" LEXINGTON TABLE PEDESTAL KIT	LEXBLKIT4	5110
--	------------------	------

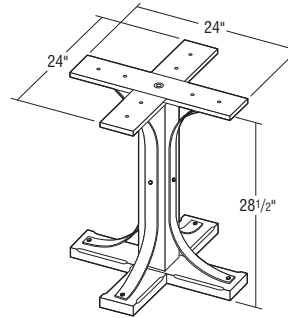

- 24" x 28 1/2".
- Alder will be used for Rustic Alder.
- Not available in Quartersawn Oak or Walnut.
- Kit comes unassembled.
- Metal components are black matte sheen with matching hardware.

Custom Modification Options

F.ALL
✓

4" LEXINGTON ISLAND PEDESTAL KIT	LEXISLKIT4	5386
---	-------------------	------

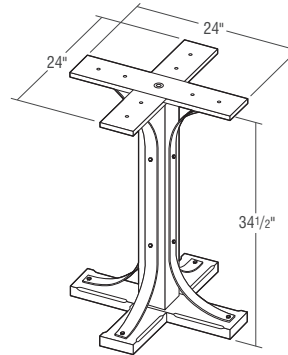

- 24" x 34 1/2".
- Alder will be used for Rustic Alder.
- Not available in Quartersawn Oak or Walnut.
- Kit comes unassembled.
- Metal components are black matte sheen with matching hardware.

Custom Modification Options

F.ALL
✓

Mouldings & Embellishments

Description	Model	Price
CHARLESTON PEDESTAL, 29 1/2"	CHARLESESPED29	6768

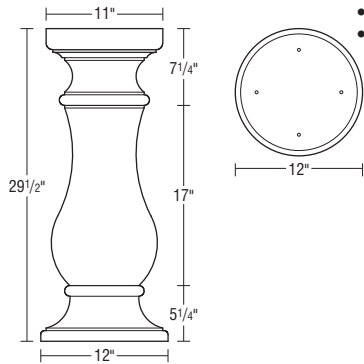

- 12" x 29 1/2".
- Alder will be used for Rustic Alder.
- Not available in Quartersawn Oak or Walnut.
- Extended lead times may apply.

Custom Modification Options
F.A.L.L.
✓

CHARLESTON PEDESTAL, 33 1/2"	CHARLESESPED33	7376
-------------------------------------	-----------------------	------

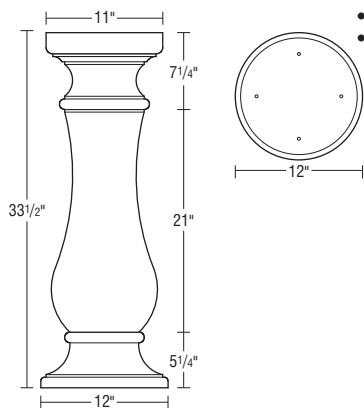

- 12" x 33 1/2".
- Alder will be used for Rustic Alder.
- Not available in Quartersawn Oak or Walnut.
- Extended lead times may apply.

Custom Modification Options
F.A.L.L.
✓

ROUND BASE, 12" DIAMETER	ROUNDBASE12	629
---------------------------------	--------------------	-----

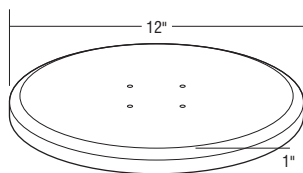

- 1" x 12".
- Alder will be used for Rustic Alder.
- Not available in Quartersawn Oak or Walnut.

Custom Modification Options
F.A.L.L.
✓

ROUND BASE, 24" DIAMETER	ROUNDBASE24	1460
---------------------------------	--------------------	------

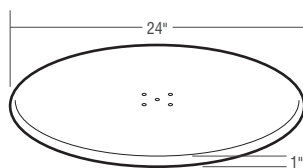

- 1" x 24".
- Alder will be used for Rustic Alder.
- Not available in Quartersawn Oak or Walnut.

Custom Modification Options
F.A.L.L.
✓

Description	Model	Price
COLUMNS		

ENGLISH COUNTRY ISLAND COLUMN	ENGISLCOLUMN	1272
--------------------------------------	---------------------	------

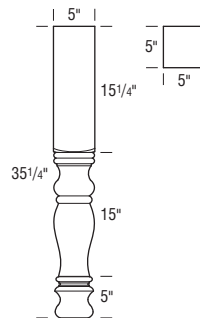

- 5" x 5" x 35 1/4".
- Alder will be used for Rustic Alder.
- Not available in Quartersawn Oak or Walnut.

Custom Modification Options
F.A.L.L.
✓

ENGLISH COUNTRY ISLAND QUARTERED COLUMN	ENGISLQTRCOL	418
--	---------------------	-----

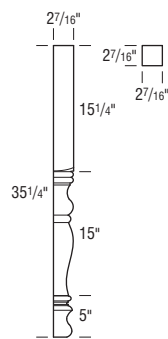

- 2 7/16" x 2 7/16" x 35 1/4".
- Alder will be used for Rustic Alder.
- Not available in Quartersawn Oak or Walnut.

Custom Modification Options
F.A.L.L.
✓

ENGLISH COUNTRY ISLAND COLUMN, DOUBLE SQUARE	ENGISLCOLUMN2	1358
---	----------------------	------

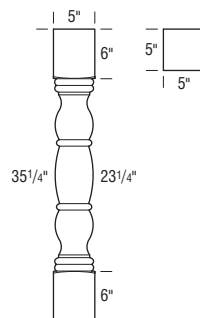

- 5" x 5" x 35 1/4".
- Alder will be used for Rustic Alder.
- Not available in Quartersawn Oak or Walnut.

Custom Modification Options
F.A.L.L.
✓

Description	Model	Price
ENGLISH COUNTRY ISLAND QUARTERED COLUMN, DOUBLE SQUARE	ENGLISLQTRCOL2	442

- 2 7/16" x 2 7/16" x 35 1/4".
- Alder will be used for Rustic Alder.
- Not available in Quartersawn Oak or Walnut.

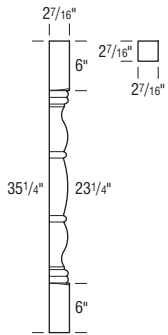

Custom Modification Options

F.A.L.L.
✓

METRO ISLAND COLUMN	METISLCOLUMN	1126
----------------------------	---------------------	------

- 3 3/4" x 3 3/4" x 35 1/4".
- Alder will be used for Rustic Alder.
- Not available in Quartersawn Oak or Walnut.

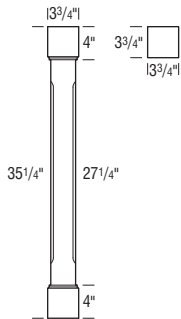

Custom Modification Options

F.A.L.L.
✓

METRO ISLAND COLUMN, SMALL	METISLCOLUMNS	682
-----------------------------------	----------------------	-----

- 3" x 3" x 34 5/8".
- Alder will be used for Rustic Alder.
- Not available in Walnut.

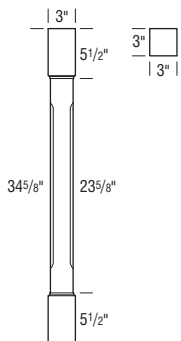

Custom Modification Options

F.A.L.L.
✓

METRO BAR COLUMN	METBARCOLUMN	754
-------------------------	---------------------	-----

- 3 3/4" x 3 3/4" x 42 1/4".
- Alder will be used for Rustic Alder.
- Not available in Walnut.

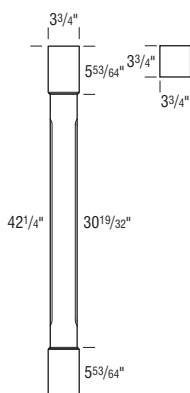

Custom Modification Options

F.A.L.L.
✓

Description	Model	Price
BAROQUE COLUMN	BARISLCOLUMN	1210

- 3" x 5 1/2" x 34 1/2".
- Alder will be used for Rustic Alder.
- Not available in Quartersawn Oak or Walnut.

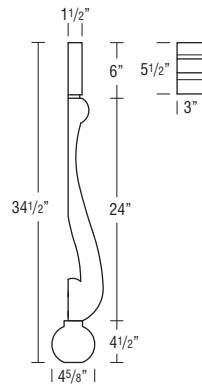

Custom Modification Options

F.A.L.L.
✓

PLAIN NOUVEAU ISLAND COLUMN	NOULEG	2436
------------------------------------	---------------	------

- 3 1/2" x 3 1/2" x 35 1/4".
- Alder will be used for Rustic Alder.
- Not available in Quartersawn Oak or Walnut.
- Abbey Column Inserts available. See page R-49.

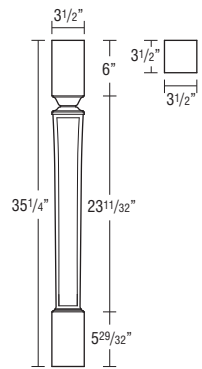

Custom Modification Options

F.A.L.L.
✓

PLAIN NOUVEAU BAR COLUMN	NOULEGT	3898
---------------------------------	----------------	------

- 5 1/2" x 5 1/2" x 41".
- Alder will be used for Rustic Alder.
- Not available in Quartersawn Oak or Walnut.
- Abbey Column Inserts available. See page R-49.

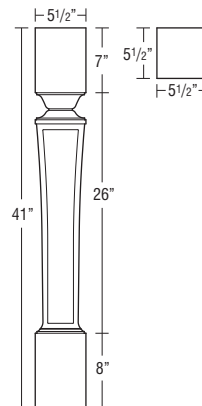

Custom Modification Options

F.A.L.L.
✓

Mouldings & Embellishments

Description	Model	Price
-------------	-------	-------

QUEEN ANNE BUFFET COLUMN **QALEGT** 1054

- 3 1/2" x 3 1/2" x 42 1/4"
- Alder will be used for Rustic Alder.
- Not available in Quartersawn Oak or Walnut.

Custom Modification Options

F.A.L.L.
✓

Description	Model	Price
-------------	-------	-------

WEAVED ISLAND COLUMN **WEAVELEG** 1228

- 3 3/4" x 3 3/4" x 35 1/4"
- Alder will be used for Rustic Alder.
- Not available in Quartersawn Oak or Walnut.

Modifications Are Not Available

Description	Model	Price
-------------	-------	-------

LARGE DIAMOND WEAVED ISLAND COLUMN **WEAVELEGL** 1773

- 5" x 5" x 35 1/4"
- Alder will be used for Rustic Alder.
- Not available in Quartersawn Oak or Walnut.

Modifications Are Not Available

Description	Model	Price
-------------	-------	-------

URBAN ISLAND COLUMN, COUNTER **URBISLCOLUMNC** 900

- 3" x 35 1/4"
- Alder will be used for Rustic Alder.
- Oak will be used for Quartersawn Oak.
- Not available in Walnut.

Custom Modification Options

F.A.L.L.
✓

Description	Model	Price
-------------	-------	-------

URBAN ISLAND COLUMN, BAR **URBISLCOLUMNB** 1042

- 3" x 42 1/2"
- Alder will be used for Rustic Alder.
- Oak will be used for Quartersawn Oak.
- Not available in Walnut.

Custom Modification Options

F.A.L.L.
✓

Description	Model	Price
-------------	-------	-------

URBAN ISLAND COLUMN, DOUBLE BEVEL, COUNTER **URBISLCOLUMNCD** 900

- 3" x 35 1/4"
- Alder will be used for Rustic Alder.
- Oak will be used for Quartersawn Oak.
- Not available in Walnut.

Custom Modification Options

F.A.L.L.
✓

Description	Model	Price
-------------	-------	-------

URBAN ISLAND COLUMN, DOUBLE BEVEL, BAR **URBISLCOLUMNBD** 1042

- 3" x 42 1/2"
- Alder will be used for Rustic Alder.
- Oak will be used for Quartersawn Oak.
- Not available in Walnut.

Custom Modification Options

F.A.L.L.
✓

Description	Model	Price
-------------	-------	-------

2 1/2" PACIFIC RIM ISLAND COLUMN **PRISLCOLUMN3** 1035

- 2 1/2" x 35 1/4"
- Alder will be used for Rustic Alder.
- Oak will be used for Quartersawn Oak.
- Not available in Walnut.

Custom Modification Options

F.A.L.L.
✓

Description	Model	Price
3 3/4" PACIFIC RIM ISLAND COLUMN	PRISLCOLUMN4	1479

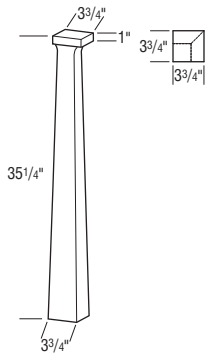

- 3 3/4" x 35 1/4".
- Alder will be used for Rustic Alder.
- Oak will be used for Quartersawn Oak.
- Not available in Walnut.

Custom Modification Options

F.ALL
✓

PACIFIC RIM ISLAND COLUMN	PRISLCOLUMN	1685
----------------------------------	--------------------	------

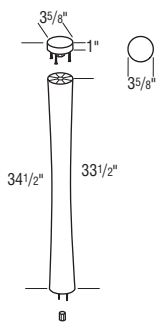

- 3 5/8" x 34 1/2".
- Alder will be used for Rustic Alder.
- Oak will be used for Quartersawn Oak.
- Not available in Walnut.

Custom Modification Options

F.ALL
✓

34 1/2" PACIFIC RIM CREATE A COLUMN	PRCCOLUMN35	1131
--	--------------------	------

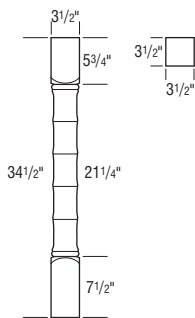

- 3 1/2" x 34 1/2".
- Alder will be used for Rustic Alder.
- Oak will be used for Quartersawn Oak.
- Not available in Walnut.

Custom Modification Options

F.ALL
✓

MID-CENTURY ISLAND COLUMN	MCISLCOLUMN	1019
----------------------------------	--------------------	------

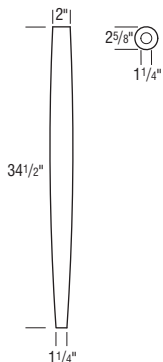

- 2 5/8" x 34 1/2".
- Alder will be used for Rustic Alder.
- Oak will be used for Quartersawn Oak.
- Not available in Walnut.

Custom Modification Options

F.ALL
✓

Description	Model	Price
NOTCHED MID-CENTURY ISLAND COLUMN	NMCISLCOLUMN	1623

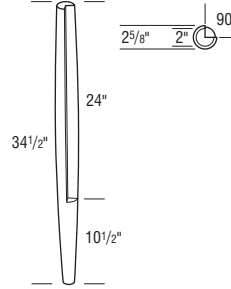

- 2 5/8" x 34 1/2".
- Alder will be used for Rustic Alder.
- Oak will be used for Quartersawn Oak.
- Not available in Walnut.

Custom Modification Options

F.ALL
✓

MID-CENTURY VANITY COLUMN	MCVANCOLUMN	725
----------------------------------	--------------------	-----

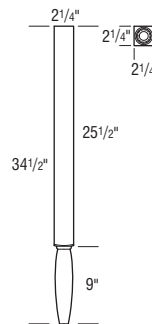

- 2 1/4" x 34 1/2".
- Alder will be used for Rustic Alder.
- Oak will be used for Quartersawn Oak.
- Not available in Walnut.

Custom Modification Options

F.ALL
✓

NOTCHED MID-CENTURY VANITY COLUMN	NMCVANCOLUMN	1603
--	---------------------	------

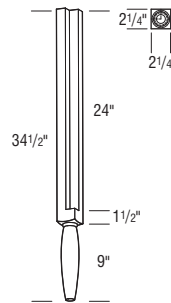

- 2 1/4" x 34 1/2".
- Alder will be used for Rustic Alder.
- Oak will be used for Quartersawn Oak.
- Not available in Walnut.

Custom Modification Options

F.ALL
✓

CHARLESTON BEAD COLUMN with FOOT	WFOOTCHARLESTON	837
---	------------------------	-----

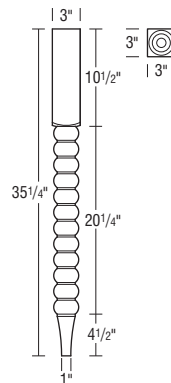

- 3" x 3" x 35 1/4".
- Alder will be used for Rustic Alder.
- Not available in Quartersawn Oak or Walnut.

Custom Modification Options

F.ALL
✓

Mouldings & Embellishments

Description	Model	Price
CHARLESTON BEAD COLUMN, DOUBLE SQUARE	DBLSQCHARLESTON	837

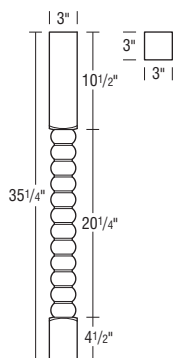

- 3" x 3" x 35 1/4".
- Alder will be used for Rustic Alder.
- Not available in Quartersawn Oak or Walnut.

Custom Modification Options

F.A.L.L.
✓

SUMTER ISLAND COLUMN, DOUBLE SQUARE	DBLSQSUMTERS	2099
--	---------------------	------

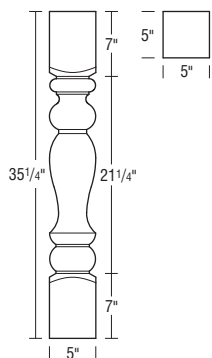

- 5" x 5" x 35 1/4".
- Alder will be used for Rustic Alder.
- Not available in Quartersawn Oak or Walnut.

Custom Modification Options

F.A.L.L.
✓

SUMTER TABLE COLUMN, DOUBLE SQUARE	DBLSQTBLS	2045
---	------------------	------

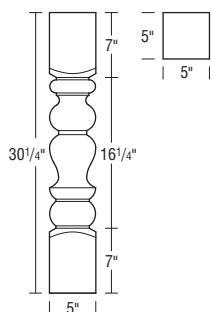

- 5" x 5" x 30 1/4".
- Alder will be used for Rustic Alder.
- Not available in Quartersawn Oak or Walnut.

Custom Modification Options

F.A.L.L.
✓

Description	Model	Price
CONTEMPORARY CAP for 3" COLUMN	CONCAP-3	402

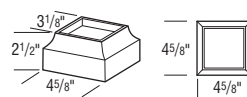

- 2 1/2" x 4 5/8" x 4 5/8".
- Alder will be used for Rustic Alder.
- Oak will be used for Quartersawn Oak.
- Not available in Walnut.

Custom Modification Options

F.A.L.L.
✓

CONTEMPORARY CAP for 4" COLUMN	CONCAP-4	423
---------------------------------------	-----------------	-----

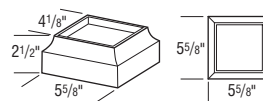

- 2 1/2" x 5 5/8" x 5 5/8".
- Alder will be used for Rustic Alder.
- Oak will be used for Quartersawn Oak.
- Not available in Walnut.

Custom Modification Options

F.A.L.L.
✓

CONTEMPORARY CAP for 5" COLUMN	CONCAP-5	515
---------------------------------------	-----------------	-----

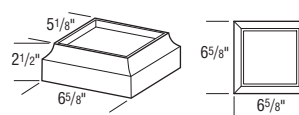

- 2 1/2" x 6 5/8" x 6 5/8".
- Alder will be used for Rustic Alder.
- Oak will be used for Quartersawn Oak.
- Not available in Walnut.

Custom Modification Options

F.A.L.L.
✓

CONTEMPORARY CAP for 6" COLUMN	CONCAP-6	538
---------------------------------------	-----------------	-----

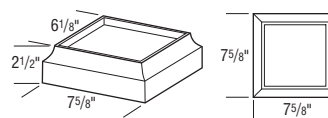

- 2 1/2" x 7 5/8" x 7 5/8".
- Alder will be used for Rustic Alder.
- Oak will be used for Quartersawn Oak.
- Not available in Walnut.

Custom Modification Options

F.A.L.L.
✓

Description	Model	Price
ABBAY COLUMN INSERT - ISLAND	ABBAYCOLINSWI	547

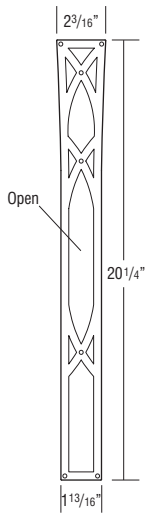

- Wrought Iron
- 1/8" x 2 3/16" x 20 1/4".
- Must be used as an insert for Plain Nouveau Island Column (NOULEG).
- No Finish Techniques available.

Custom Modification Options

F.ALL
✓

ABBAY COLUMN INSERT - BAR	ABBAYCOLINSTWI	573
----------------------------------	-----------------------	-----

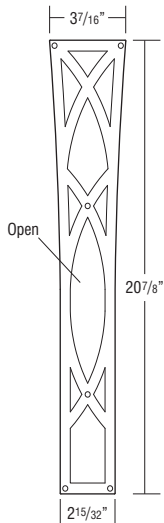

- Wrought Iron
- 1/8" x 3 7/16" x 20 7/8".
- Must be used as an insert for Plain Nouveau Bar Column (NOULEG).
- No Finish Techniques available.

Custom Modification Options

F.ALL
✓

Description	Model	Price
X-END PANELS		

3" x 25" X-END PANEL

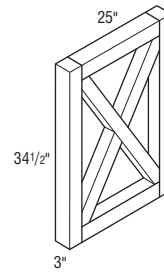

XEND325	6335
----------------	------

- 3" x 25" x 34 1/2".
- Alder will be used for Rustic Alder.
- Not available in Quartersawn Oak or Walnut.
- When applying the X-end panel to the side of a cabinet, you will want to make sure that you either skin the side of the cabinet or order as a flush finished side as the panel has openings in it.
- The panel is designed to sit out flush with the door on an adjacent cabinet.
- If using a square outside profile on a door cabinet next to the panel, you may want to consider modifying the cabinet to have a wide or extended stile to prevent binding.
- All sides finished.
- Extended lead times may apply.

Modifications
Are Not
Available

3" x 36" X-END PANEL

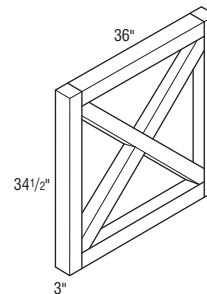

XEND336	6960
----------------	------

- 3" x 36" x 34 1/2".
- Alder will be used for Rustic Alder.
- Not available in Quartersawn Oak or Walnut.
- When applying the X-end panel to the side of a cabinet, you will want to make sure that you either skin the side of the cabinet or order as a flush finished side as the panel has openings in it.
- The panel is designed to sit out flush with the door on an adjacent cabinet.
- If using a square outside profile on a door cabinet next to the panel, you may want to consider modifying the cabinet to have a wide or extended stile to prevent binding.
- All sides finished.
- Extended lead times may apply.

Modifications
Are Not
Available

Mouldings & Embellishments

Description	Model	Price
-------------	-------	-------

1 1/2" x 25" X-END PANEL

XEND125 4552

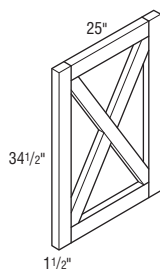

- 1 1/2" x 25" x 34 1/2".
- Alder will be used for Rustic Alder.
- Not available in Quartersawn Oak or Walnut.
- When applying the X-end panel to the side of a cabinet, you will want to make sure that you either skin the side of the cabinet or order as a flush finished side as the panel has openings in it.
- The panel is designed to sit out flush with the door on an adjacent cabinet.
- If using a square outside profile on a door cabinet next to the panel, you may want to consider modifying the cabinet to have a wide or extended stile to prevent binding.
- All sides finished.
- Extended lead times may apply.

Modifications
Are Not
Available

1 1/2" x 36" X-END PANEL

XEND136 5057

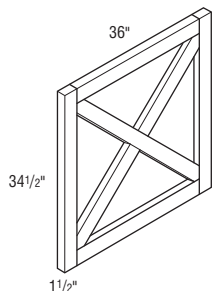

- 1 1/2" x 36" x 34 1/2".
- Alder will be used for Rustic Alder.
- Not available in Quartersawn Oak or Walnut.
- When applying the X-end panel to the side of a cabinet, you will want to make sure that you either skin the side of the cabinet or order as a flush finished side as the panel has openings in it.
- The panel is designed to sit out flush with the door on an adjacent cabinet.
- If using a square outside profile on a door cabinet next to the panel, you may want to consider modifying the cabinet to have a wide or extended stile to prevent binding.
- All sides finished.
- Extended lead times may apply.

Modifications
Are Not
Available

SWITCH PLATE COVERS

SINGLE SWITCH PLATE

SSP 171

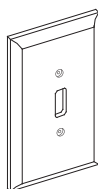

- Alder will be used for Rustic Alder.
- Oak will be used for Quartersawn Oak.
- Not available in Walnut.
- Glazes and/or Techniques available: F, TW, XTW, HW, XHW.

Modifications
Are Not
Available

Glazes and Techniques

F = Flooded (see page E•4.)
P = Penned (see page E•4.)
TW = Timeworn (see page E•4.)
XTW = Extra Timeworn (see page E•4.)
HW = Hewn (see page E•4.)
XHW = Extra Hewn (see page E•4.)

Description	Model	Price
-------------	-------	-------

DOUBLE SWITCH PLATE

DSP 253

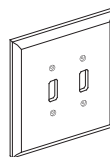

- Alder will be used for Rustic Alder.
- Oak will be used for Quartersawn Oak.
- Not available in Walnut.
- Glazes and/or Techniques available: F, TW, XTW, HW, XHW.

Modifications
Are Not
Available

ROCKER SWITCH PLATE

SINGLE ROCKER PLATE

SRP 171

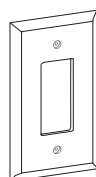

- Alder will be used for Rustic Alder.
- Not available in Walnut.
- Glazes and/or Techniques available: F, TW, XTW, HW, XHW.

Modifications
Are Not
Available

DOUBLE ROCKER PLATE

DRP 253

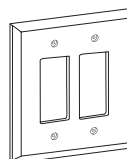

- Alder will be used for Rustic Alder.
- Not available in Walnut.
- Glazes and/or Techniques available: F, TW, XTW, HW, XHW.

Modifications
Are Not
Available

OUTLET COVERS

SINGLE OUTLET COVER

SOC 171

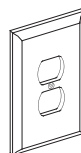

- Alder will be used for Rustic Alder.
- Oak will be used for Quartersawn Oak.
- Not available in Walnut.
- Glazes and/or Techniques available: F, TW, XTW, HW, XHW.

Modifications
Are Not
Available

DOUBLE OUTLET COVER

DOC 253

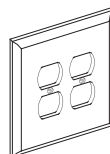

- Alder will be used for Rustic Alder.
- Oak will be used for Quartersawn Oak.
- Not available in Walnut.
- Glazes and/or Techniques available: F, TW, XTW, HW, XHW.

Modifications
Are Not
Available

ABBEY COLLECTION

ABBEY COLUMN INSERT - ISLAND
R•49

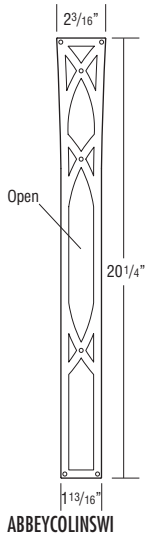

ABBEY COLUMN INSERT - BAR
R•49

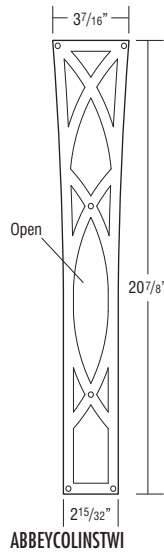

ABBEY CORBEL INSERT - LARGE
R•28

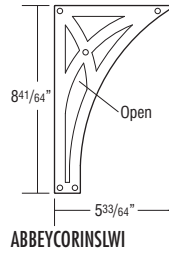

ABBEY CORBEL INSERT - MEDIUM
R•28

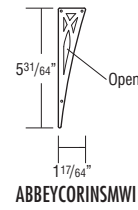

ABBEY CORBEL INSERT - SMALL
R•28

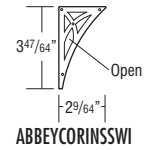

ABBEY CROWN INSERT
R•7

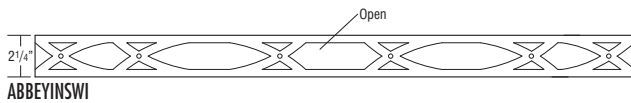

ABBEY LIGHT RAIL INSERT
R•7



PLAIN NOUVEAU ISLAND COLUMN
R•45

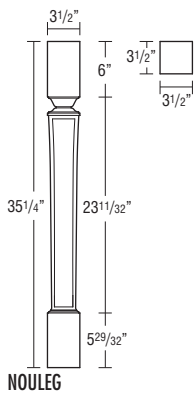

PLAIN NOUVEAU BAR COLUMN
R•45

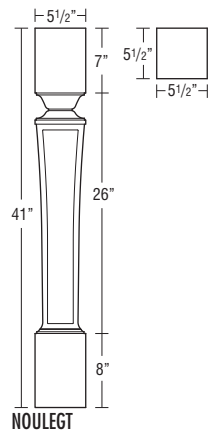

PLAIN NOUVEAU LARGE CORBEL
R•27

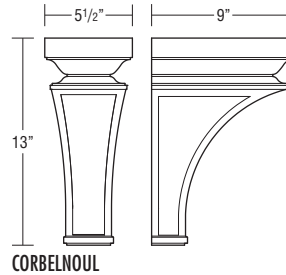

PLAIN NOUVEAU MEDIUM CORBEL
R•28

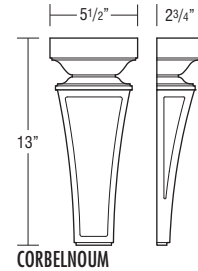

PLAIN NOUVEAU SMALL CORBEL
R•28

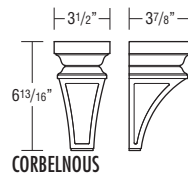

Mouldings & Embellishments

ACANTHUS COLLECTION

ACANTHUS LEG, LARGE
R•41

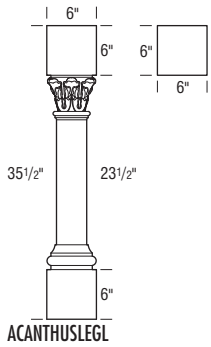

ACANTHUS LEG
R•41

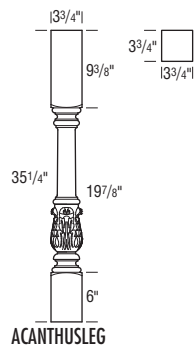

10" SMALL ACANTHUS CORBEL
R•27

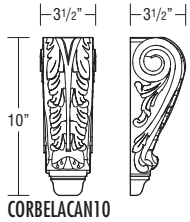

14" SMALL ACANTHUS CORBEL
R•27

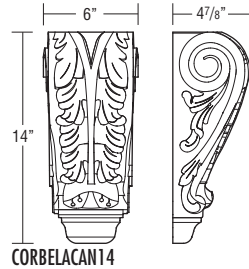

5" PETITE ACANTHUS CORBEL
R•27

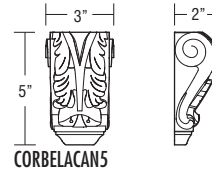

ACANTHUS FOOT
R•30

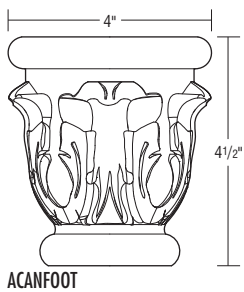

ACANTHUS ROSETTE
R•16

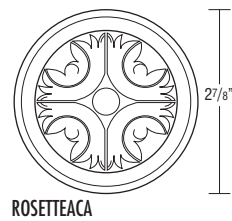

3" SPLIT TURNING ACANTHUS
R•17

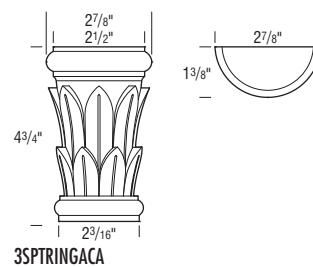

CELTIC COLLECTION

CELTIC BRACKET
R•24

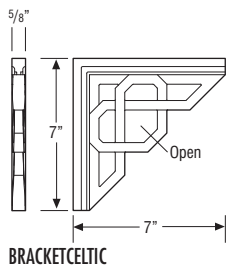

7" CELTIC CORBEL
R•26

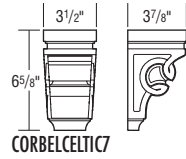

10" CELTIC CORBEL
R•26

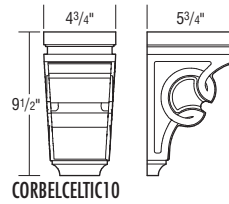

14" CELTIC CORBEL
R•26

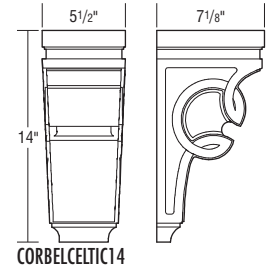

CELTIC FOOT
R•30

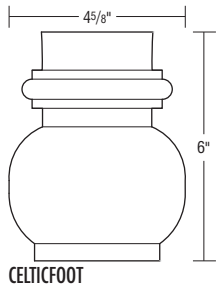

Mouldings & Embellishments

CRAFTSMAN COLLECTION

5" CLASSIC REVIVAL CORBEL
R•25

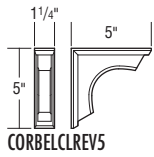

9" CLASSIC REVIVAL CORBEL
R•26

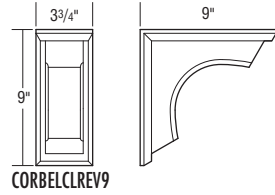

14" CLASSIC REVIVAL CORBEL
R•26

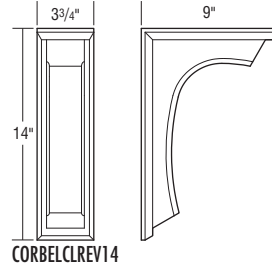

3" SHAKER CORBEL
R•27

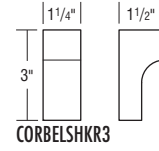

CRAFTSMAN CORBEL
R•25

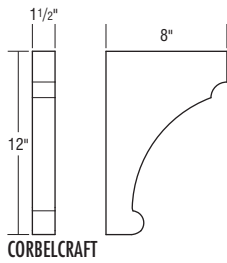

CRAFTSMAN CORBEL OPEN
R•24

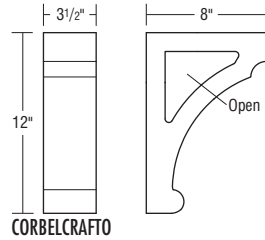

10" CRAFTSMAN CORBEL
R•25

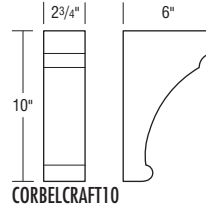

12" CRAFTSMAN CORBEL
R•25

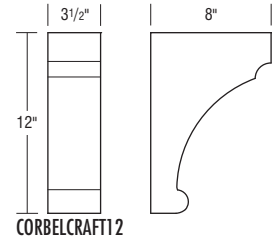

18" CRAFTSMAN CORBEL
R•25

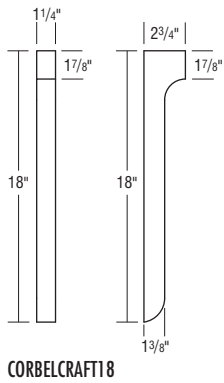

34" CRAFTSMAN CORBEL
R•25

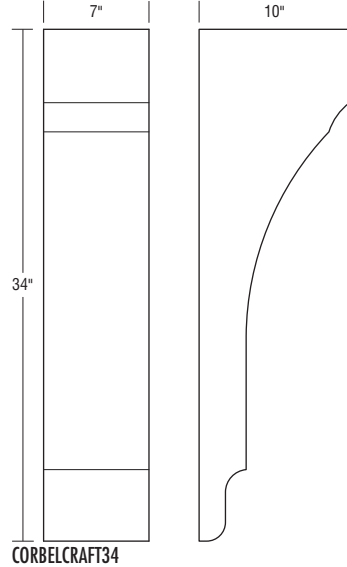

CRAFTSMAN FOOT
R•31

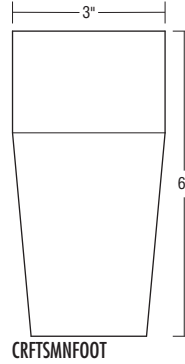

CRAFTSMAN FOOT, CORNER
R•32

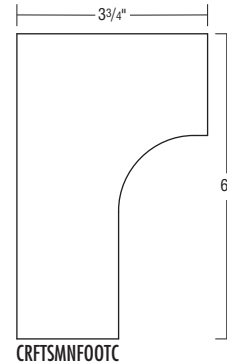

CRAFTSMAN BUN FOOT
R•32

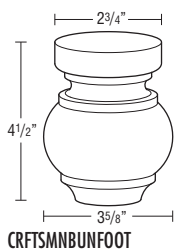

DECO COLLECTION

7" PALLADIAN CORBEL
R•25

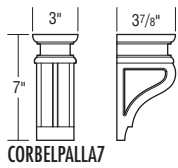

9" PALLADIAN CORBEL
R•25

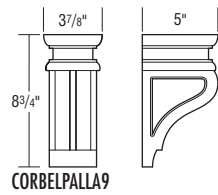

14" PALLADIAN CORBEL
R•25

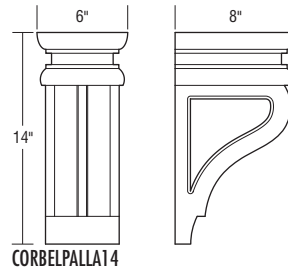

DECO BASEBOARD MOULDING
R•9

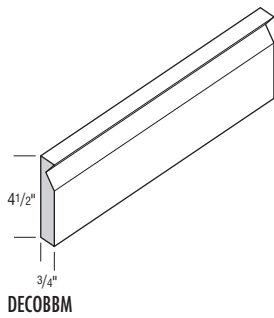

GAELIC COLLECTION

GAELIC LEG, LARGE, ROUTED
R•41

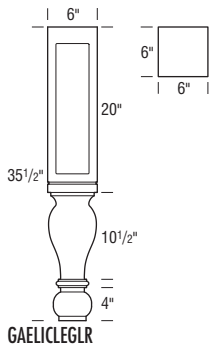

GAELIC LEG, LARGE
R•41

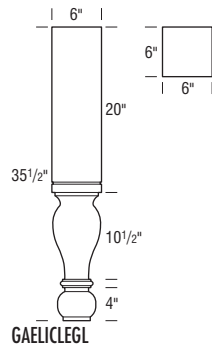

SMALL GAELIC ROSETTE
R•16

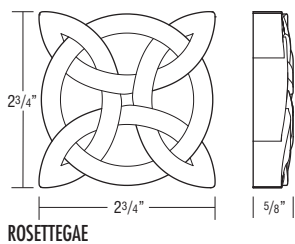

Mouldings & Embellishments

METRO COLLECTION

METRO ISLAND COLUMN
R•45

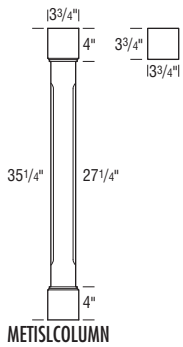

METISLCOLUMN

METRO ISLAND COLUMN, SMALL
R•45

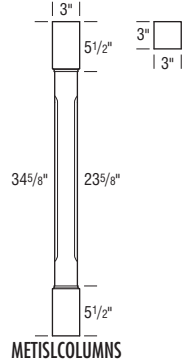

METISLCOLUMNS

METRO BAR COLUMN
R•45

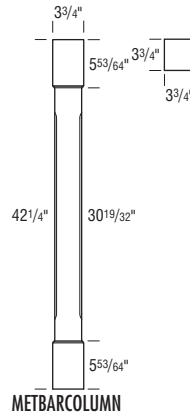

METBARCOLUMN

9" TRIAD CORBEL
R•26

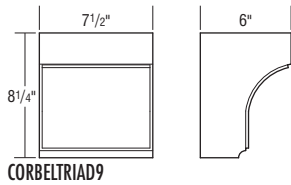

CORBELTRIAD9

6" TRIAD CORBEL
R•26

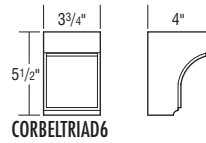

CORBELTRIAD6

14" ARTS & CRAFTS CORBEL
R•26

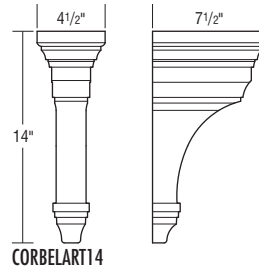

CORBELART14

ARTS & CRAFTS OPEN CORBEL
R•26

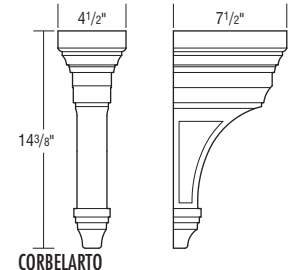

CORBELARTO

COSMO FOOT
R•30

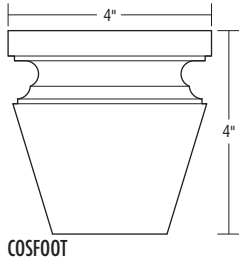

COSFOOT

TAPERED LEG
R•30

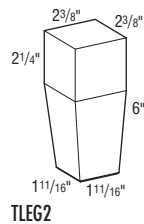

TLEG2

TAPERED 4-SIDED LEG
R•30

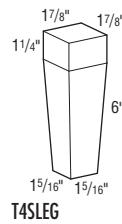

T4SLEG

MADLINE POST, LARGE
R•37

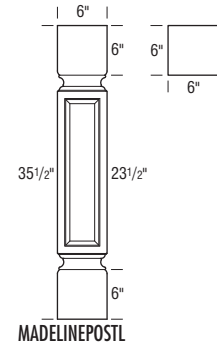

MADLINEPOSTL

TRIAD ROSETTE
R•21

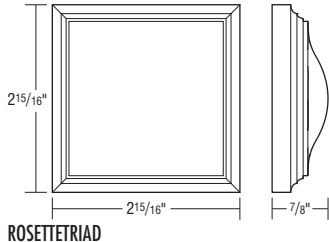

ROSETTETRIAD

SUMMIT COLLECTION

APEX LEG
R•41

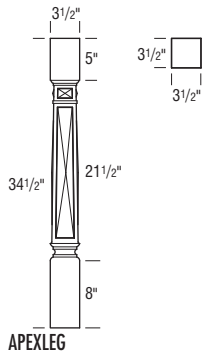

APEX LEG, TALL
R•42

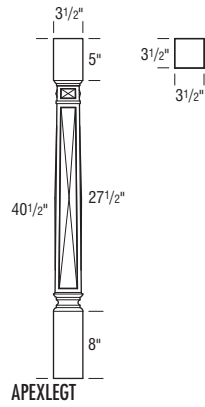

7" PINNACLE CORBEL
R•26

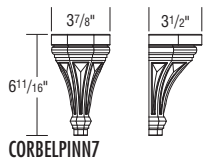

8" PINNACLE CORBEL
R•26

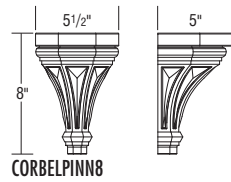

12" PINNACLE CORBEL
R•27

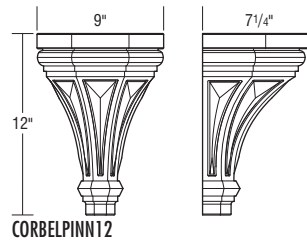

SUMMIT FOOT
R•30

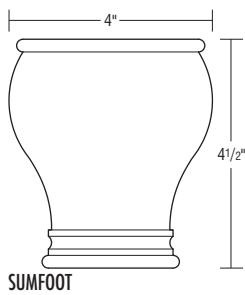

PINNACLE ROSETTE
R•21

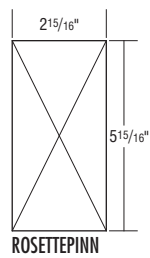

Mouldings & Embellishments

WEAVED COLLECTION

WEAVED ISLAND COLUMN

R•46

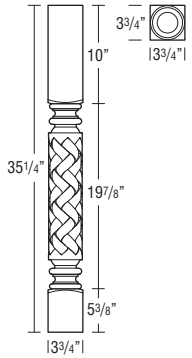

WEAVELEG

LARGE DIAMOND WEAVED ISLAND COLUMN

R•46

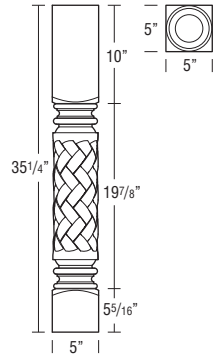

WEAVELEGL

LARGE WEAVED CORBEL

R•28

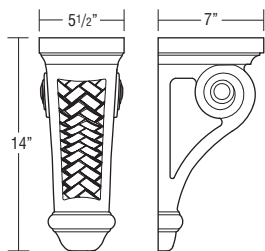

CORBELWEAVEL

SMALL WEAVED CORBEL

R•28

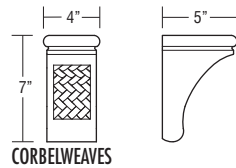

CORBELWEAVES

WEAVED BUN FOOT

R•32

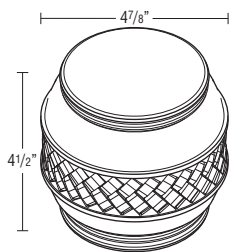

WEAVEBUNFOOT

Diamond Edge Modification Option Descriptions

Your Diamond Edge price guide contains charts with modification option codes for each applicable cabinetry product. Reference the listing below to identify the modification description.

End Panel Options	
Option	Description
INTGE	Integral End
IPE	Inset Panel Ends

Custom Modification Options	
Option	Description
IW	Increased Width
PTOWB	Push-to-Open Wastebasket
RD	Reduced Depth
SCPDRW	Scooped Drawer

Kits & Hardware

Description	Model	Price
-------------	-------	-------

INTERIOR ACCESSORY KITS

FOOD STORAGE CONTAINER ORGANIZER KIT

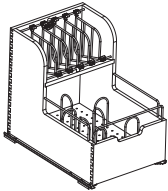

FSCO18KIT

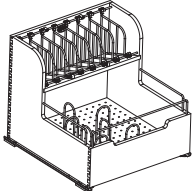

FSCO24KIT

FSCO18KIT	1200
<ul style="list-style-type: none"> For 18" wide base cabinet. 	
FSCO24KIT	1200
<ul style="list-style-type: none"> For 24" wide base cabinet. Pull-out features natural finished hardwood dovetailed box with chrome rails on lower section with undermount Smart Stop guides. Includes seven chrome "U" pegs to use on the pegboard bottom to customize the fit to container sizes. Adjustable clip-on lid dividers included to fit with a variety of lid shapes. 18" wide includes five dividers, 24" wide includes eight dividers. Front of pull-out is routed for easy access. 	
FSCO18KIT Pull-out dimensions: 14 1/2" W x 21 1/2" D x 18" H.	
FSCO24KIT Pull-out dimensions: 20 1/2" W x 21 1/2" D x 18" H.	
Not available on Inset or Beaded Inset styles.	

Modifications
Are Not
Available

BASE BOTTLE STORAGE KIT with INSTALLATION HARDWARE

BBSKIT18	490
<ul style="list-style-type: none"> For 18" wide base cabinet. 	

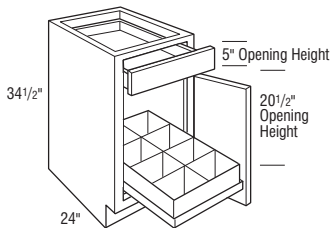

Modifications
Are Not
Available

BASE CAN STORAGE KIT for BPP



BPPKIT9PG	1155
<ul style="list-style-type: none"> For 9" wide base cabinet. 	
BPPKIT12PG	1244
<ul style="list-style-type: none"> For 12" wide base cabinet. 	
BPPKIT15PG	1760
<ul style="list-style-type: none"> For 15" wide base cabinet. 	
BPPKIT18PG	1892
<ul style="list-style-type: none"> For 18" wide base cabinet. 	

Modifications
Are Not
Available

To calculate the inside drawer box width to determine organization units and/or parts to order, utilize the following formula: Frame Opening Width - 1 5/8" = Interior Drawer Box Width

Description	Model	Price
-------------	-------	-------

KIT COMPONENTS for BUPP

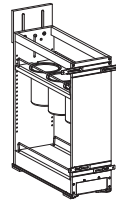

BUPPKIT9	1287
-----------------	------

- For 9" wide base cabinet.
- Canisters are 5.85" tall and have an inside diameter of 4.3".

BUPPKIT12	1374
------------------	------

- For 12" wide base cabinet.
- Canisters are 6.7" tall and have an inside diameter of 5".

- Top shelf features three stainless steel (removable) canisters for utensils.
- Features Smart Stop pull-out with two adjustable shelves (including canister shelf) and one fixed shelf with chrome rails.

Modifications
Are Not
Available

KIT COMPONENTS for BUPPKB

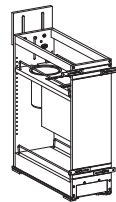

BUPPKBKIT12

BUPPKBKIT12	1833
--------------------	------

- For 12" wide base cabinet.
- Includes one stainless steel canister 6.7" tall with an inside diameter of 5", and knife block.

BUPPKBKIT15	2225
--------------------	------

- For 15" wide base cabinet.
- Includes two stainless steel canisters 5.85" tall with an inside diameter of 4.3", and two stainless steel canisters 6.7" tall with an inside diameter of 5".

- Features Smart Stop pull-out with adjustable knife and canister shelf and one fixed shelf with chrome rails.
- Knife block features movable flex rods that adjust to hold a multitude of knives.

Modifications
Are Not
Available

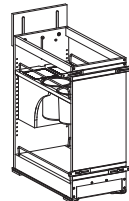

BUPPKBKIT15

KIT COMPONENTS for BTDPP

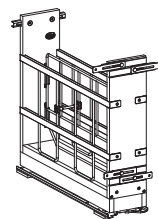

BTDPPKIT9

BTDPPKIT9	1417
------------------	------

- For 9" wide base cabinet.
- Includes one removable center divider and one snap on T-bar.

BTDPPKIT12	1506
-------------------	------

- For 12" wide base cabinet.
- Includes two removable center dividers and two snap on T-bars.

- Tray dividers are chrome plated steel.

Modifications
Are Not
Available

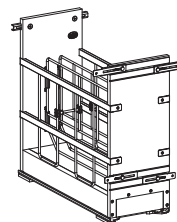

BTDPPKIT12

Description	Model	Price
KIT COMPONENTS for BCOPP	BCOPPKIT12	2029

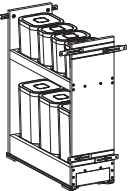

- Features Smart Stop slides.
- Includes 7 OXO Good Grips® POP containers, BPA Free: (3) 1.7 quart, (1) 2.6 quart, (3) 4.3 quart.
- Fixed shelf.

Modifications Are Not Available

Description	Model	Price
BASE OPEN BASKET KITS	BASKET15	929
	BASKET18	935



- Includes single basket and pair of rails.

Modifications Are Not Available

Description	Model	Price
BASE PANS STORAGE	BPS24KIT	964
	BPS30KIT	1060
	BPS36KIT	1167

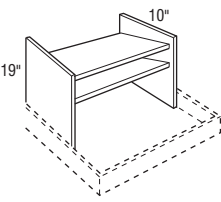

- Not available for 12" deep cabinets.
- Kit is designed to be used with roll trays.

Modifications Are Not Available

Description	WIDTH	
	Kit Size	Price
BREAD BOARD with INSTALLATION HARDWARE	BBOARDKIT12	299
	BBOARDKIT15	343
	BBOARDKIT18	368
	BBOARDKIT21	390
	BBOARDKIT24	412

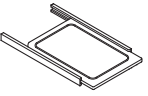

- Bread Boards are 21/32" thick.

Kit Size	Cabinet Width
12"	12" Base
15"	15" Base
18"	18" Base
21"	21" Base
24"	24" Base

Modifications Are Not Available

Description	Model	Price
COOKING UTENSIL DIVIDER	CUDD24	262
	CUDD30	293
	CUDD36	323

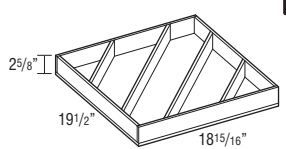

CUDD24

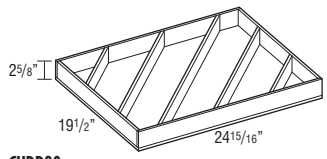

CUDD30

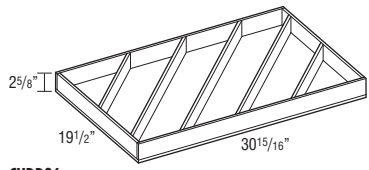

CUDD36

- Pre-assembled natural wood drawer insert (does not fit roll trays).
- CUDD24 for use in 24" wide base cabinets.
- CUDD30 for use in 30" wide base cabinets.
- CUDD36 for use in 36" wide base cabinets.

Modifications Are Not Available

Kits & Hardware

Description	Model	Price
COOKING UTENSIL DIVIDER	CUD15	144
	CUD18	144
	CUD21	173
	CUD24	210
	CUD27	250
	CUD30	269
	CUD33	290
	CUD36	309

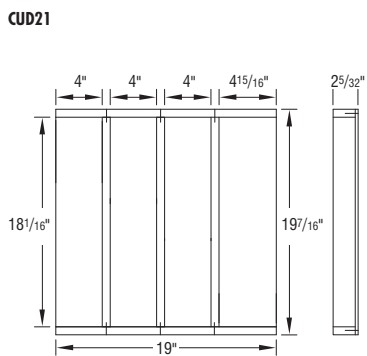
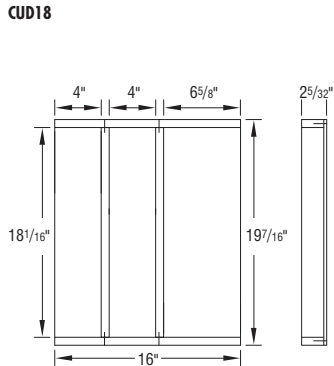
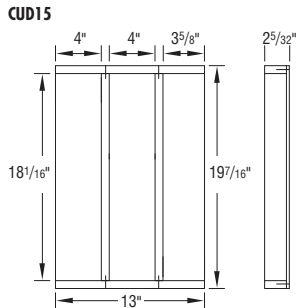
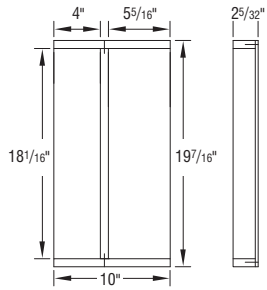

- Available in 24" deep cabinets.
- Increased Heights not available.
- Increased Widths available in 1/4" increments. See page G-46 for details.
- CUD is not trimmable.

Model	No. of Vertical Dividers
CUD15	1
CUD18	2
CUD21	2
CUD24	3
CUD27	4
CUD30	4
CUD33	5
CUD36	5

End Panel Options

INTGE IPE

Custom Modification Options

IW¹ PTOWB RD SCPDRW

¹ Not available in 36 version.

Description	Model	Price
COOKING UTENSIL DIVIDER (cont'd)		

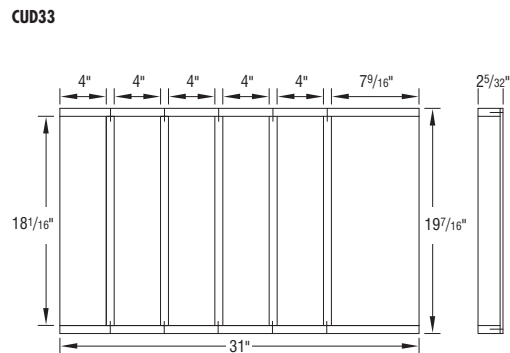
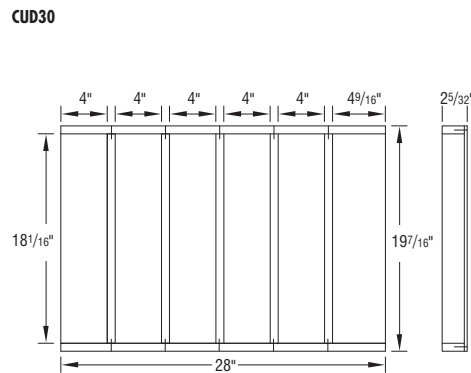
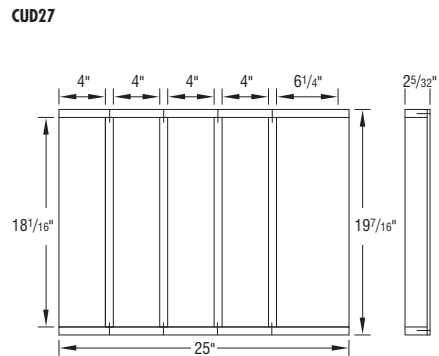
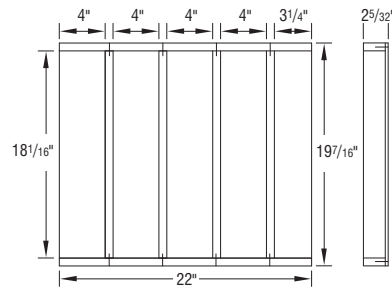

To calculate the inside drawer box width to determine organization units and/or parts to order, utilize the following formula: $\text{Frame Opening Width} - 1 \frac{5}{8}'' = \text{Interior Drawer Box Width}$

Description	Model	Price
CUTLERY DIVIDER	CIW1221	118
	CIW1224	118
	CIW13.521	118
	CIW13.524	118
	CIW1521	118
	CIW1524	118
	CIW16.521	118
	CIW16.524	118
	CIW1821	118
	CIW1824	118
	CIW19.521	145
	CIW19.524	145
	CIW2121	145
	CIW2124	145
	CIW22.521	145
	CIW22.524	145
	CIW2421	177
	CIW2424	177
	CIW2721	177
	CIW2724	177
	CIW3021	177
	CIW3024	177
	CIW3321	205
	CIW3324	205
	CIW3621	205
	CIW3624	205

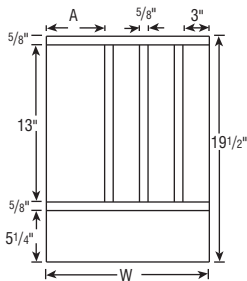

- Features Maple wood.
- Cutlery dividers are only available in 24" or 21" deep cabinets.
- Specify size.
- 2 5/32" high.

Model	W Dim.	A Dim.	No. of Vertical Dividers
CIW1221	7"	3 3/8"	1
CIW1224	7"	3 3/8"	1
CIW13.521	8 1/2"	4 7/8"	1
CIW13.524	8 1/2"	4 7/8"	1
CIW1521	10"	2 3/4"	2
CIW1524	10"	2 3/4"	2
CIW16.521	11 1/2"	4 1/4"	2
CIW16.524	11 1/2"	4 1/4"	2
CIW1821	13"	6 3/4"	2
CIW1824	13"	6 3/4"	2
CIW19.521	14 1/2"	3 5/16"	3
CIW19.524	14 1/2"	3 5/16"	3
CIW2121	16"	6 1/8"	3
CIW2124	16"	6 1/8"	3
CIW22.521	17 1/2"	3"	4
CIW22.524	17 1/2"	3"	4
CIW2421	19"	4 1/2"	4
CIW2424	19"	4 1/2"	4
CIW2721	22"	3 7/8"	5
CIW2724	22"	3 7/8"	5
CIW3021	25"	3 1/4"	6
CIW3024	25"	3 1/4"	6
CIW3321	28"	2 5/8"	7
CIW3324	28"	2 5/8"	7
CIW3621	31"	6 3/8"	7
CIW3624	31"	6 3/8"	7

Modifications
Are Not
Available

Description	Model	Price
WOOD TIERED CUTLERY DIVIDER DRAWER with INSTALLATION HARDWARE	WTCD15	591
	WTCD18	609
	WTCD21	631
	WTCD24	650
	WTCD30	900
	WTCD36	900

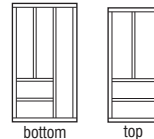
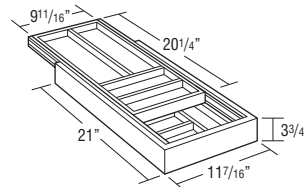

WTCD15

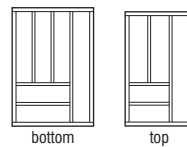
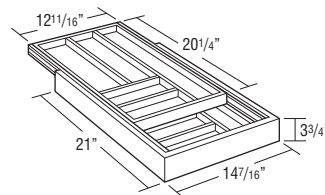

WTCD18

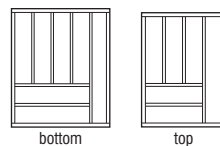
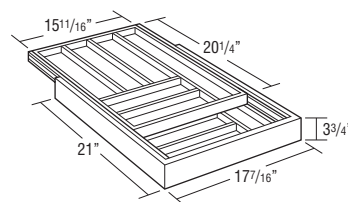

WTCD21

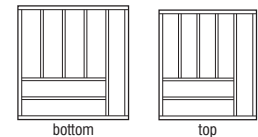
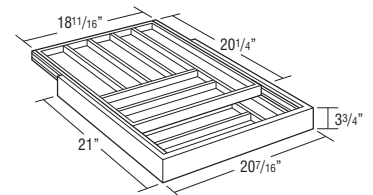

WTCD24

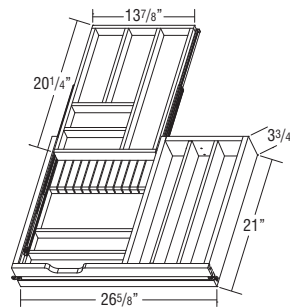

WTCD30

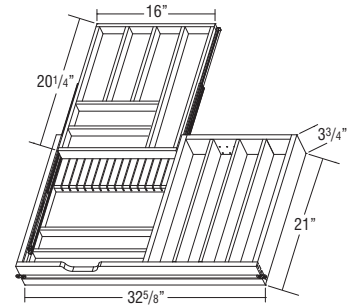

WTCD36

- Replaces standard drawer (5" high frame opening).
- Requires field installation of drawer front.
- For use with 24" deep cabinets only.
- Exterior WTCD drawer box height is 3 3/4", interior height of top and bottom tier is 1 3/8".
- Includes Drawer Guides.

Modifications
Are Not
Available

Kits & Hardware

Description	Model	Price
WOOD TIERED K-CUP* DRAWER with INSTALLATION HARDWARE	KCUPT18	797

- Replaces standard drawer (5" high frame opening).
- Requires field installation of drawer front.
- Holds 40 K-Cups.
- The Wood Tiered K-Cup Drawer is compatible with K-Cup pods only.
- For use with 24" deep cabinets only.
- Exterior Wood Tiered K-Cup drawer box height is 3 3/4", interior height of top tier is 1 5/8", and interior height of bottom tier is 1 3/8".
- Includes Drawer Guides.
- Only for use in 18" wide units.

*K-Cup is a registered trademark of Keurig Green Mountain, Inc.

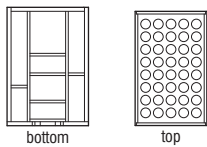
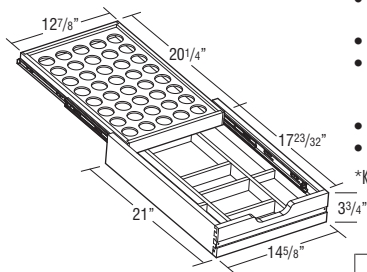

Modifications Are Not Available

Description	Model	Price
CHARGING DRAWER	CHGDRW18	1250

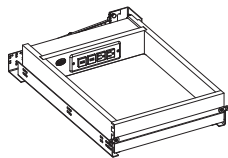

- Replaces standard drawer (5" high frame opening).
- Requires field installation of drawer front.
- Designed for 18" base cabinet drawers.
- Full extension, concealed Smart Stop slides.
- 110 lb. rated.
- 120V outlet must be installed in rear of cabinet within 10" of bottom of drawer, in rear of cabinet.
- CUL US listed power strip with two 120V plugs and two 2.1 amp USB ports.
- Max Current: AC 15 amps @ 120VAC; USB 2.1 amp and 5 VDC each.
- Tamper resistant outlets.
- Power cord with NEMA 5-15 plug.
- Integrated card guide mounts to cabinet side to ensure safe operation.
- Black, shock absorbing mat included.
- Special sizes not available.
- For use with 24" deep cabinets only.
- Not available on Inset or Beaded Inset Styles.

Modifications Are Not Available

Description	Model	Price
WOOD TIERED VANITY DRAWER KIT	WTVD12	500
	WTVD15	500
	WTVD18	500

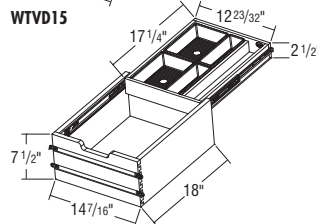
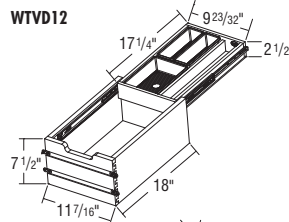
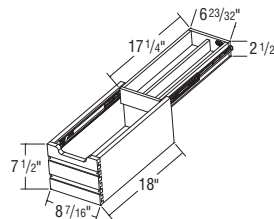

WTVD18

Modifications Are Not Available

Description	Model	Price
TILT-OUT TRAY(S) STAINLESS STEEL for USE BEHIND FALSE DRAWER FRONT	TOTSSS10	274
	TOTSSS13	274
	TOTSSS16	274
	TOTSSS19	274
	TOTSSS25	274
	TOTSSS31	274

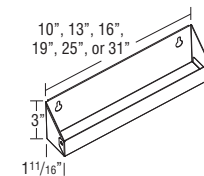

- Tilt-out trays protrude 3/4" into the cabinet on Full Overlay Styles and 1 11/16" into Inset and Beaded Inset styles.
- Two tilt-out scissor hinges per tray.

For field installation behind drawer fronts on SB and VSB units.

Cabinet Width	No. of Cabinet False Panels on Cabinet	Tilt-out Tray to Order	No. of Tilt-out Trays Needed
18"	1	TOTSSS13	1
21"	1	TOTSSS16	1
24"	1	TOTSSS19	1
27"	1	TOTSSS19	1
30"	1	TOTSSS25	1
33"	1	TOTSSS25	1
33"	2	TOTSSS10	2
36"	1	TOTSSS31	1
36"	2	TOTSSS13	2
39"	1	TOTSSS31	1
39"	2	TOTSSS13	2
42"	2	TOTSSS16	2
45"	2	TOTSSS16	2
48"	2	TOTSSS19	2

Modifications Are Not Available

Description

U-SHAPED ROLL TRAY KIT

U-SHAPED DRAWER
ON SELECT BATH
BASE CABINETS

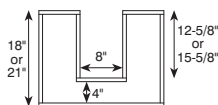

Model	Price
URT24SP	412
• Available in 1/4" increments from 24" to 26 3/4" wide	
URT27SP	460
• Available in 1/4" increments from 27 1/4" to 29 3/4" wide	
URT30SP	460
• Available in 1/4" increments from 30 1/4" to 32 3/4" wide	
URT33SP	460
• Available in 1/4" increments from 33 1/4" to 35 3/4" wide	
URT36SP	460

Notes below apply to all products in section above:

- 8" and 4" dimensions of U-shape stays constant for all drawer box sizes, the legs of U-shape are either 12 5/8" or 15 5/8".
- Available in conjunction with Scooped Drawer.
- Not available with: Any drawer insert or pull-out (CD, BB, WTC, etc.).

End Panel Options



Custom Modification Options



U-SHAPED DEEP ROLL TRAY KIT

U-SHAPED DRAWER
ON SELECT BATH
BASE CABINETS

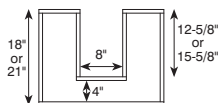

UDRT24SP	412
• Available in 1/4" increments from 24" to 26 3/4" wide	
UDRT27SP	460
• Available in 1/4" increments from 27 1/4" to 29 3/4" wide	
UDRT30SP	460
• Available in 1/4" increments from 30 1/4" to 32 3/4" wide	
UDRT33SP	460
• Available in 1/4" increments from 33 1/4" to 35 3/4" wide	
UDRT36SP	460

Notes below apply to all products in section above:

- 8" and 4" dimensions of U-shape stays constant for all drawer box sizes, the legs of U-shape are either 12 5/8" or 15 5/8".
- Available in conjunction with Scooped Drawer.
- Not available with: Any drawer insert or pull-out (CD, BB, WTC, etc.).

End Panel Options



Custom Modification Options



BATH GLASS SHELF

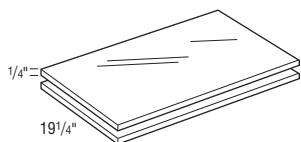

GSK1221	305
GSK1521	317
GSK1821	322
GSK2121	362
GSK2421	379
GSK2721	385
GSK3021	395

- Kit includes two 1/4" tempered glass shelves.
- Glass shelves sized to fit standard cabinet with no modifications that affect the size of the shelf. Integral End, Inset Panel End, Clipped Corner modification not available in conjunction with glass shelf kit.

Modifications
Are Not
Available

Description

GLASS SHELF KITS

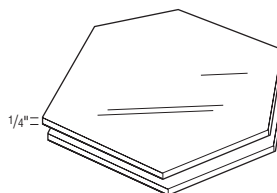
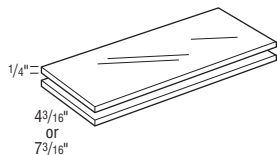
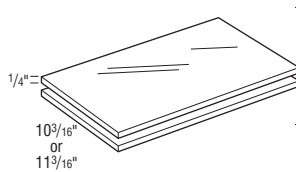

GSKDW27

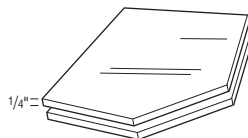

GSKDW24

Model	Price
GSK912	220
GSK913	220
GSK1206	207
GSK1209	207
GSK1212	233
GSK1213	233
GSK1506	214
GSK1509	214
GSK1512	242
GSK1513	242
GSK1806	220
GSK1809	220
GSK1812	246
GSK1813	246
GSK2106	251
GSK2109	251
GSK2112	289
GSK2113	289
GSK2406	263
GSK2409	263
GSK2412	303
GSK2413	303
GSK2706	268
GSK2709	268
GSK2712	310
GSK2713	310
GSK3006	274
GSK3009	274
GSK3012	320
GSK3013	320
GSK3306	290
GSK3309	290
GSK3312	340
GSK3313	340
GSK3606	305
GSK3609	305
GSK3612	368
GSK3613	368
GSKDW24*	463
GSKDW24P	474
GSKDW2413	463
GSKDW2413P	474
GSKDW27	463

* Glass Shelves not available for DW182424 L or R, DW242424 L or R, and DW242727 L or R.

- Kit includes two 1/4" tempered glass shelves.
- Glass shelves sized to fit standard cabinet with no modifications that affect the size of the shelf. Integral End, Inset Panel End, Clipped Corner modification not available in conjunction with glass shelf kit.

Modifications
Are Not
Available

Kits & Hardware

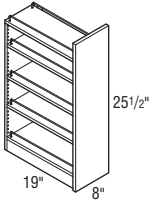
Description	Model	Price
HEARTH TOWER PULL-OUT KIT	HPPKIT12	841
	<ul style="list-style-type: none"> Smart Stop feature not available. 	<div style="border: 1px solid black; padding: 5px; width: fit-content;"> Modifications Are Not Available </div>

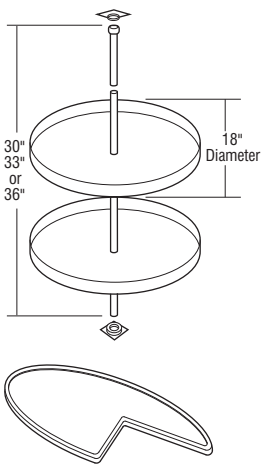
Description	Model	Price
LAZY SUSAN KIT	DWLKIT24	173
	<ul style="list-style-type: none"> For DW Diagonal Wall 30" Opening 	
	BLSKIT33	258
	<ul style="list-style-type: none"> For BLS36 L or R Lazy Susan Base 33 	
	BLSKIT36	258
	<ul style="list-style-type: none"> For BLS36 L or R Lazy Susan Base 36 	
	BER36SKIT	336
	<ul style="list-style-type: none"> For SLSB36 Square Lazy Susan Base 36 	
	DAB36KIT	399
	<ul style="list-style-type: none"> For DAB36S L or R Diagonal Square Lazy Susan Base 36 	
	<p>Notes below apply to all products in section above:</p> <ul style="list-style-type: none"> Includes 2 roto trays; pole and hardware included. 	
BRDB36KIT	646	
<ul style="list-style-type: none"> For BRDB36 L or R Base Rotating Deep Bin 36 		
SLS33KIT	333	
<ul style="list-style-type: none"> For SSS33 Super Space Saver 33 		
SLS36KIT	338	
<ul style="list-style-type: none"> For SSS36 Super Space Saver 36 		
SLS3CR33KIT	523	
<ul style="list-style-type: none"> For SLS3CR336 L or R and SLS3CR33RS L or R 		
SLS3CR36KIT	570	
<ul style="list-style-type: none"> For SLS3CR36 L or R and SLS3CR36RS L or R 		
<p>Notes below apply to all products in section above:</p> <ul style="list-style-type: none"> Includes 1 roto tray; shelf not included. Mounts to shelf or floor, no pole or hardware required. 		
<div style="border: 1px solid black; padding: 5px; width: fit-content;"> Modifications Are Not Available </div>		

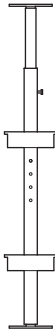
Description	Model	Price
LAZY SUSAN POLE KIT	LSPOLEKIT	114
	<ul style="list-style-type: none"> Required for DWLKIT24, BLSKIT33, BLSKIT36, BER36SKIT and DAB36KIT. Includes pole and required hardware. 	<div style="border: 1px solid black; padding: 5px; width: fit-content;"> Modifications Are Not Available </div>

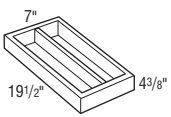
Description	Model	Price
LID ORGANIZER	LO	372
	<ul style="list-style-type: none"> Available only for 24" deep cabinets with roll tray. 7" W x 19 1/2" D x 4 3/8" H. Each opening is 2 3/4". 	<div style="border: 1px solid black; padding: 5px; width: fit-content;"> Modifications Are Not Available </div>

Description	Model	Price
MIXER SHELF with POP-UP SHELF and INSTALLATION HARDWARE	MIXKIT18	1073
	<ul style="list-style-type: none"> For 18" wide base cabinet 	
	MIXKIT21	1079
	<ul style="list-style-type: none"> For 21" wide base cabinet 	
	MIXKIT24	1085
	<ul style="list-style-type: none"> For 24" wide base cabinet 	
	<ul style="list-style-type: none"> Mixer Shelf features Smart Stop. For use in cabinet with full height door only. 	
	<div style="border: 1px solid black; padding: 5px; width: fit-content;"> Modifications Are Not Available </div>	

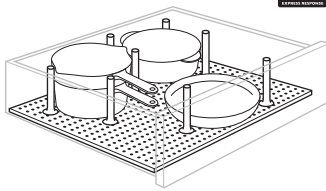
Description	Model	Price
PEGGED DISH ORGANIZER	PDO	493
	<ul style="list-style-type: none"> 8 posts and board 	
	PDOPOSTS	119
	<ul style="list-style-type: none"> 4 posts For use in 36" wide Base Cabinets. Pegged board is 19/32" thick. 29 15/16" x 19 1/2". 	
	<div style="border: 1px solid black; padding: 5px; width: fit-content;"> Modifications Are Not Available </div>	

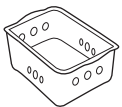
Description	Model	Price
PLASTIC STORAGE BINS for BPSB	PSBKIT15	453
	<ul style="list-style-type: none"> For 15" wide base cabinet 	
	PSBKIT18	453
	<ul style="list-style-type: none"> For 18" wide base cabinet 	
	<ul style="list-style-type: none"> Kit includes 3 storage bins. 	
	<div style="border: 1px solid black; padding: 5px; width: fit-content;"> Modifications Are Not Available </div>	

Description	Model	Price
POTS and PANS PULL-OUT KITS	PPP24KIT	1149
	PPP30KIT	1560

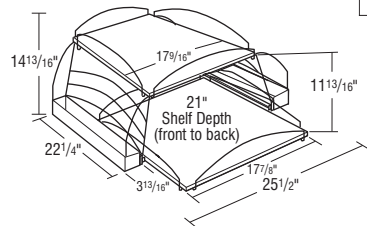
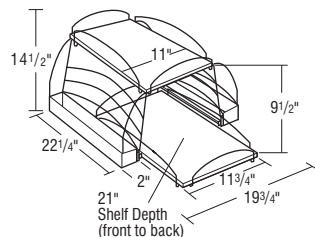

Modifications Are Not Available

- Smart Stop feature not available on pull-out.
- Pull-out mounts to floor of cabinet.
- 24" pull-out dimensions: 19 3/4" W x 14 1/2" H x 22 1/4" D
- 30" pull-out dimensions: 25 1/2" W x 14 13/16" H x 22 1/4" D

ROLL TRAY KIT – ONE ROLL TRAY PER KIT

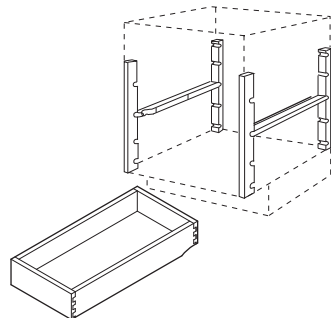

ROLL TRAY QUANTITY	MINIMUM OPENING HEIGHT
1	9
2	9
3	13.5
4	17.5
5	21

RT12SP	412
RT13.5SP	412
RT15SP	412
RT16.5SP	412
RT18SP	412
RT19.5SP	412
RT21SP	412
RT22.5SP	412
RT24SP	412
RT27SP	460
RT30SP	460
RT33SP	460
RT36SP	460
DGK12FXSRTPG*	217
DGK15FXSRTPG*	217
DGK18FXSRTPG*	217
DGK21FXSRTPG*	217
DGK24FXSRTPG*	217

- *Includes slides, uprights, and cross-members.
- Wooden trays with wood mounting brackets and mounting slides.
 - If cabinet has FFD on end, roll trays will not install properly.
 - Widths 39" and over will require two roll trays.
 - Reduced Depths available in 1/4" increments from 12" to 23 3/4".
 - Increased Widths available in 1/4" increments. See page G•46 for details.
 - All available modifications include: Increased Widths and Reduced Depths.
 - Not available on peninsula cabinets.

End Panel Options



Custom Modification Options



¹ Not available on DGK versions.

² Not available on DGK versions or RT36SP.

DEEP ROLL TRAY KIT – ONE ROLL TRAY PER KIT

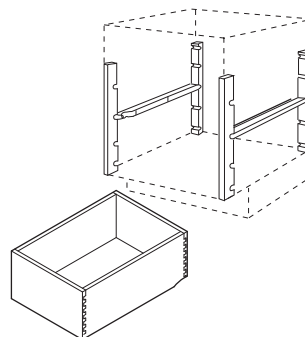

ROLL TRAY QUANTITY	MINIMUM OPENING HEIGHT
1	9
2	20
3	30
4	41
5	51

Description	Model	Price
DRT12SP		560
DRT13.5SP		560
DRT15SP		560
DRT16.5SP		560
DRT18SP		560
DRT19.5SP		560
DRT21SP		560
DRT22.5SP		560
DRT24SP		560
DRT27SP		608
DRT30SP		608
DRT33SP		608
DRT36SP		608
DDGK12FXSRTPG*		217
DDGK15FXSRTPG*		217
DDGK18FXSRTPG*		217
DDGK21FXSRTPG*		217
DDGK24FXSRTPG*		217

*Includes slides, uprights, and cross-members.

- Wooden trays with wood mounting brackets and mounting slides.
- If cabinet has FFD on end, roll trays will not install properly.
- Widths 39" and over will require two roll trays.
- Reduced Depths available in 1/4" increments from 12" to 23 3/4".
- Increased Widths available in 1/4" increments. See page G•46 for details.
- All available modifications include: Increased Widths and Reduced Depths.
- Not available on peninsula cabinets.

End Panel Options



Custom Modification Options



¹ Not available on DDGK versions.

Kits & Hardware

Description	Model	Price
NEW SCOOPED ROLL TRAY KIT – ONE ROLL TRAY PER KIT	SRT12SP	472
	SRT13.5SP	472
	SRT15SP	472
	SRT16.5SP	472
	SRT18SP	472
	SRT19.5SP	472
	SRT21SP	472
	SRT22.5SP	472
	SRT24SP	472
	SRT27SP	520
	SRT30SP	520
	SRT33SP	520
	SRT36SP	520
	SDGK21FXSRTPG*	277
	SDGK24FXSRTPG*	277

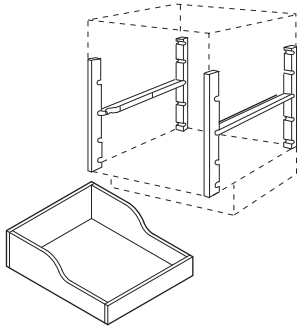

ROLL TRAY QUANTITY	MINIMUM OPENING HEIGHT
1	9
2	16
3	24
4	33
5	41

- *Includes slides, uprights, and cross-members only. Roll Tray not included.
- Wooden trays with wood mounting brackets and mounting slides.
 - If cabinet has FFD on end, roll trays will not install properly.
 - Widths 39" and over will require two roll trays.
 - Reduced Depths available in 1/4" increments from 21" to 23 3/4".
 - Not available on peninsula cabinets.

End Panel Options

INTGE	IPE
-------	-----

Custom Modification Options

IW ¹	PTOWB	RD ¹	SCPDRW
<input checked="" type="checkbox"/>	<input type="checkbox"/>	<input checked="" type="checkbox"/>	<input type="checkbox"/>

¹ Not available on SDGK versions.

Description	Model	Price
SLIDING TOWEL BAR	STR	178

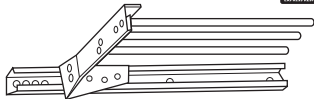

- Minimum opening width is 9".
- Not available in conjunction with Clipped Corner or Wide Stiles.
- Minimum cabinet depth of 21".

Modifications Are Not Available

Description	Model	Price
SPICE DRAWER	SD18	221
	SD24	253

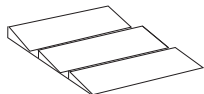

- Available in 24" depth only.
- Not trimmable.

Modifications Are Not Available

Description	Model	Price
SPICE PULL-OUT	SPICE12PG	540
	SPICE15PG	599

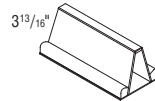

- Available in 24" depth only.
- For BSP & BCS only.

Modifications Are Not Available

Description	Model	Price
STEM GLASS HOLDER	WGH15	236
	WGH18	303
	WGH21	368
	WGH24	416
	WGH27	474
	WGH30	525
	WGH33	583
	WGH36	641

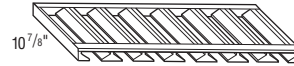

MODEL	DIM.	SLOTS
WGH15	12 1/8"	3
WGH18	16"	4
WGH21	19 13/16"	5
WGH24	19 7/8"	5
WGH27	23 21/32"	6
WGH30	27 17/32"	7
WGH33	31 7/16"	8
WGH36	34 7/16"	9

Modifications Are Not Available

Description	Model	Price
TRAY DIVIDER	TDKIT21	202
	TDKIT27	202

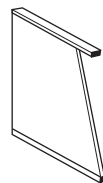

- Divider sent loose; use Modifications section for installed option.
- Two-sided with natural maple standard.

Modifications Are Not Available

Description	Model	Price
TRAY DIVIDER ROLL-OUT	TDRO12	338
	TDRO15	375
	TDROHDWONLY*	217

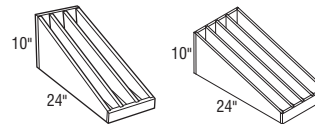

*Includes slides, cross-members and uprights. TDROHDWONLY must be ordered for the installation of the TDRO.

- For 12" and 15" wide Base cabinets.
- 12" dimensions – 7 9/16" W x 21" D x 10" H.
- 15" dimensions – 10 9/16" W x 21" D x 10" H.
- Not available on Inset or Beaded Inset Styles.

Modifications Are Not Available

Description	Model	Price
VANITY BASE PULL-OUT KIT for VBP	VBPKIT12	841



- Smart Stop feature not available.

Modifications Are Not Available

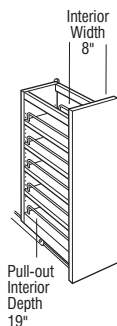

WALL SPICE PULL-OUT KIT for WSP	WSPKIT09	782
	WSPKIT12	841



- Pull-out features Smart Stop.

Modifications Are Not Available

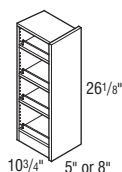

POWER POD L G I X	PWRPODBK	822
	PWRPODGM	1176
	PWRPODSS	1176



- Sensio Power Pod - Black
- Sensio Power Pod - Gun Metal
- Sensio Power Pod - Stainless

- Includes independent power switch, three electrical sockets, and two USB ports (located above power switch).
- 18" of clearance required below surface mount location and 3 1/2" diameter hole is required in countertop to install.
- This item requires field installation. This accessory can not be installed above drawers.
- Safe for countertop installation; rated IP54-splash proof from splashing water and water jets per IPX waterproof specifications; ETL approved-compliant for electrical and other safety standards to North American safety including: UL, ANSI, CSA, ASTM, and NFPA standards.
- When installed, top lip of strip sits on top of countertop with a pivoting handle. Handle is pulled up to bring bottom of power strip to countertop.

Modifications Are Not Available

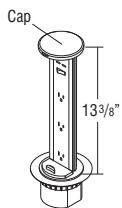

Description	Model	Price
TABLET HOLDER	TABLEHLDR	312



- Mounts under 15" cabinet or wider.
- Designed for cabinets 12" deep or deeper.
- Features an acrylic mounting base and pull-down tablet holder tray.
- Tray is movable forward and backward with a slight side to side rotation, and can be utilized at any position.
- Tray has side cut-outs for a charging cord and can be used to store most tablets when closed, depending on overall thickness, width, height, and weight of the tablet.
- Maximum dimensions for tablet: 11 1/4" x 8 1/2" x 1 1/8" thick. Maximum tablet weight is 3 1/2 lbs.
- Tablet Holder has an overall height of 1 17/32" when installed and in closed position (measured from the bottom panel of the cabinet), 0.78" visible from front of cabinet when closed.
- Installation instructions included.

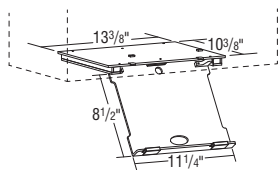

Modifications Are Not Available

WASTEBASKET ASSEMBLY with INSTALLATION HARDWARE for BWB CABINET with DRAWER	BWB15KIT	642
	BWB15KIT2	655
	BWB18KIT	675
	BWB21KIT	717
	BWB24KIT	753

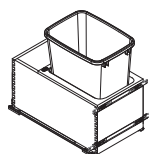

BWB15KIT

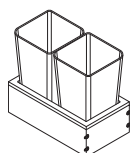

BWB15KIT2



BWB18KIT

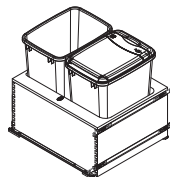

BWB21KIT-BWB24KIT

- For 15" wide base cabinet
- For 15" wide base cabinet
- For 18" wide base cabinet
- For 21" wide base cabinet
- For 24" wide base cabinet
- Wastebasket dimensions for BWB**KIT – 14 3/8" W x 18" H x 10 1/2" D.
- Wastebasket dimensions for BWB15KIT2 – 10 5/8" W x 17 3/4" H x 10 5/8" D.
- BWB15KIT includes one 35 quart wastebasket.
- BWB15KIT2 has two 27 quart wastebaskets.
- BWB18KIT, BWB21KIT, and BWB24KIT hold two 35 quart wastebaskets. One wastebasket includes lid.
- Wastebasket is a metallic gray.
- Full height door recommended for 21" and 24" dual wastebaskets on inset cabinets. For non-full height door styles, it is recommended that the front wastebasket be removed for easier removal of the back wastebasket.
- Wastebasket pull-out box will be 6 3/8" high.

End Panel Options



Custom Modification Options



¹ Not available on 24" version.

Kits & Hardware

Description	Model	Price
WASTEBASKET ASSEMBLY with INSTALLATION HARDWARE for BWB CABINET with FULL HEIGHT DOOR	BWB15FHKIT	1123
	• For 15" wide base cabinet	
	BWB15FHKIT2	655
	• For 15" wide base cabinet	
	BWB18FHKIT	1149
• For 18" wide base cabinet		
BWB18FHKIT2	675	
• For 18" wide base cabinet		
BWB21FHKIT	1153	
• For 21" wide base cabinet		
BWB24FHKIT	1153	
• For 24" wide base cabinet		

BWB15FHKIT-BWB18FHKIT

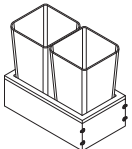

BWB15FHKIT2

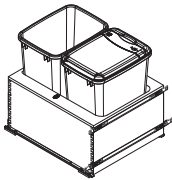

BWB18FHKIT2

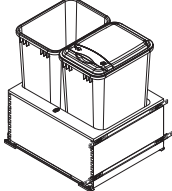

BWB21FHKIT-BWB24FHKIT

- Wastebasket dimensions for BWB**FHKIT – 14 3/4" W x 21 3/4" H x 10 11/16" D.
- Wastebasket dimensions for BWB15FHKIT2 – 10 5/8" W x 17 3/4" H x 10 5/8" D.
- Wastebasket dimensions for BWB18FHKIT2 – 10 1/2" W x 18" H x 14 3/8" D
- BWB15FHKIT and BWB18FHKIT hold one 50 quart wastebasket.
- BWB15FHKIT2 has two 27 quart wastebaskets.
- BWB18KITFH2 has two 35 quart wastebaskets and one lid.
- BWB21FHKIT and BWB24FHKIT hold two 50 quart wastebaskets. One wastebasket includes lid.
- Wastebasket is a metallic gray.
- BWB15FHKIT will have a 6 3/8" high wastebasket pull-out box.
- BWB**FHKIT and BWB18FHKIT2 will have a 10" high wastebasket pull-out box.
- Full height door recommended for 21" and 24" dual wastebaskets on inset cabinets. For non-full height door styles, it is recommended that the front wastebasket be removed for easier removal of the back wastebasket.

End Panel Options

INTGE	IPE
-------	-----

Custom Modification Options

IW	PTOWB ¹	RD	SCPDRW
	<input checked="" type="checkbox"/>		

¹ Not available on 24" version.

Description	Model	Price
WASTEBASKET ONLY for BWB (27 QUART)	WASTEBIN27	55
	• For 15" wide base cabinets.	
	• For 6 3/8" high wastebasket pull-out box.	
	• 2 wastebaskets required.	
	• Wastebasket dimensions – 10 5/8" W x 10 5/8" D x 17 3/4" H.	
	• Wastebasket is a metallic gray.	
Modifications Are Not Available		

Description	Model	Price
WASTEBASKET ONLY for BWB (35 QUART)	WASTEBIN35	60
	• For 15", 18", 21" and 24" wide base cabinets.	
	• 2 wastebaskets required for 18", 21", or 24" wide base cabinets.	
	• Wastebasket dimensions – 14 1/4" W x 17 7/8" H x 10 7/16" D.	
	• Wastebasket is a metallic gray.	
	• For 6 3/8" high wastebasket pull-out box.	
Modifications Are Not Available		

Description	Model	Price
WASTEBASKET ONLY for BWB (50 QUART)	WASTEBIN50	92
	• For 18" and 21" wide base cabinets.	
	• One 50 quart wastebasket for 18" application.	
	• Two 50 quart wastebaskets for 21" application.	
	• Wastebasket dimensions – 14 3/4" W x 21 3/4" H x 10 11/16" D.	
	• Wastebasket is a metallic gray.	
• For 10" high wastebasket pull-out box.		
Modifications Are Not Available		

Description	Model	Price	
BASE WASTEBASKET LID	BWBLID	87	
	• Designed to be used with the BWB trash units.		
	• Fits 35 quart wastebaskets.		
	• Sold individually.		
	Modifications Are Not Available		

Description	Model	Price	
BASE WASTEBASKET LID	BWBFHLID	87	
	• Designed to be used with the BWB__FH trash units.		
	• Fits 50 quart wastebaskets.		
	• Sold individually.		
	Modifications Are Not Available		

Description	Model	Price	
CHROME HAMPER with CREME LINEN LINER ONLY for VBH/VSHDB/4DVSHDB/LCRH	HAMPERKIT18	821	
	• For 18" wide base cabinet		
	• Hamper size is 14 9/16" W x 17 23/32" D x 18 15/16" H.		
	Modifications Are Not Available		

Description	Model	Price
AUTOMATIC OPENING MECHANISM PARTS		

AUTOMATIC OPENING MECHANISM ACTIVATION SWITCH



AOMACTSWITCH 217

Modifications Are Not Available

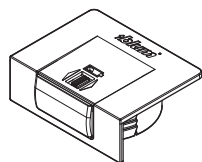

AUTOMATIC OPENING MECHANISM CABLE CONNECTOR



AOMCABLECONN 41

Modifications Are Not Available

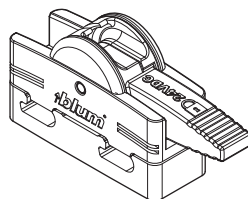

AUTOMATIC OPENING MECHANISM CABLE END PROTECTOR



AOMCABLEPROT 12

Modifications Are Not Available



AUTOMATIC OPENING MECHANISM UNIVERSAL CABLE, 26'



AOMCABLE 245

Modifications Are Not Available



AUTOMATIC OPENING MECHANISM CABLE CLIP



AOMCABLECLIP 21

Modifications Are Not Available

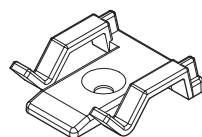

LID PULL-OUT KIT



LH12KIT 1213

- Lid pull-out will hold 6 lids per tray.
- Maximum lid diameter is 8 1/2" on bottom tray and 9 3/4" on top tray.
- Requires a minimum opening of 12" wide x 24 1/2" high x 21" deep.
- Installation to bottom and back, may require block out on side for extra support.

Modifications Are Not Available

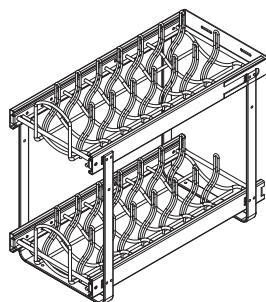

POTS and PANS PULL-OUT KIT



Description	Model	Price
POTS and PANS PULL-OUT KIT	PPH15KIT	1283
	PPH21KIT	1712

- PPH15KIT Pots and Pans pull-out includes 8 dividers per tray for adjustable storage.
- PPH15KIT requires a minimum opening of 15" wide x 24 1/2" high x 21" deep.
- PPH21KIT Pots and Pans pull-out includes 16 dividers per tray for adjustable storage.
- PPH21KIT requires a minimum opening of 21" wide x 24 1/2" high x 21" deep.
- Installation to bottom and back, may require block out on side for extra support.

Modifications Are Not Available

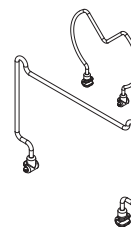
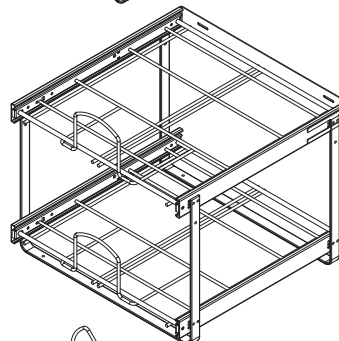
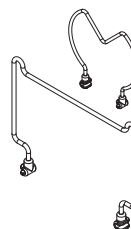
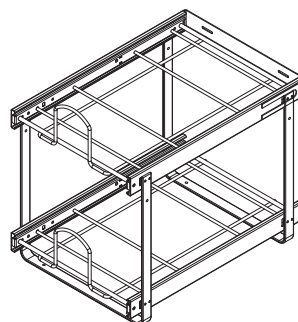

CABMAT™



CABMAT30	300
CABMAT33	300
CABMAT36	300

- Designed to capture spills and is removable for cleaning.
- Not trimmable. Can also be used in wider cabinets but will create a small void of unprotected area along the end panels.
- CabMat™ is also available installed as a modification for easy size selection by cabinet, see CMAT on page G-37.
- Inset on sink base cabinets will utilize the vanity CabMat™ size.

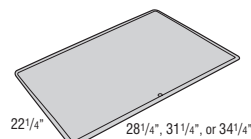

	Liquid Capacity		Cabinet Size	
	Gallons	Liters	Width	Depth
CABMAT30	2.0	7.6	30"	24"
CABMAT33	2.4	9.0	33"	24"
CABMAT36	2.7	10.2	36"	24"

Modifications Are Not Available

Kits & Hardware

Description	Model	Price
CABMAT™ VANITY	CABMATV24	300
	CABMATV30	300
	CABMATV36	300

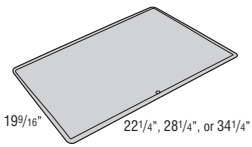

- Designed to capture spills and is removable for cleaning.
- Not trimmable. Can also be used in wider cabinets but will create a small void of unprotected area along the end panels.
- CabMat™ is also available installed as a modification for easy size selection by cabinet, see CMAT on page 6•37.
- CabMat™ not available on inset vanity cabinets.

	Liquid Capacity		Cabinet Size	
	Quarts	Liters	Face Frame Opening	Depth
CABMATV24	2.5	2.4	21"–24"	21"
CABMATV30	3.3	3.1	27"–30"	21"
CABMATV36	3.9	3.7	33"	21"

Modifications Are Not Available

Description	Model	Price
SINK BASE CLEANING CADDY	SBCADDYSM	928

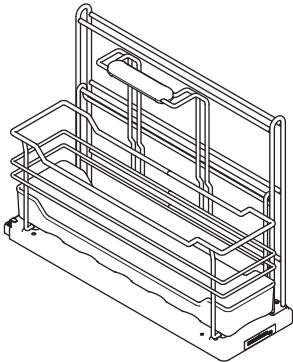

- Includes one removable basket with handle and four dividers.
- Bottom mounted full extension, Smart Stop slides.
- Caddy dimensions are 6 3/8" wide x 15 3/4" high x 18 1/2" deep.
- Caddy fits in cabinets with a minimum: 9" wide x 16" high (frame opening) x 21" deep.

Modifications Are Not Available

Description	Model	Price
SINK BASE CLEANING CADDY	SBCADDY	1213

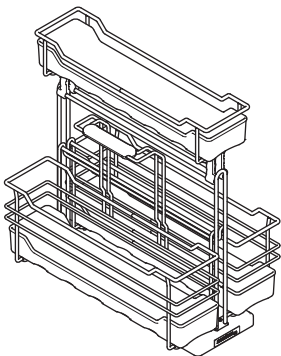

- L or R designates installed side.
- Includes one removable basket with handle, one basket without handle, swivel basket and 8 dividers.
- Bottom mounted full extension, Smart Stop slides.
- Caddy dimensions are 11" wide x 20" high x 18 1/2" deep.
- Caddy fits in cabinets with a minimum: 12" wide (15" for inset) x 20 1/2" high (frame opening) x 21" deep.

Modifications Are Not Available

Description	Model	Price
MISCELLANEOUS ITEMS		

PLASTIC SHELF CLIPS – STANDARD

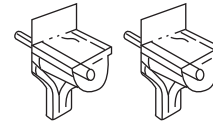

Description	Price
SHELFPEGS	10

- Includes 12 plastic shelf clips and 3mm steel pin with clear plastic shoulder.

Modifications Are Not Available

Description	Model	Price
MULLION DOOR CLIPS	MDCLIPS	27



- Package of 6 includes clear plastic retainer clips, screws, and PVC inserts.
- For use when inserting glass for Diamond Edge Mullion Doors and Cut-For-glass Doors.
- Five styles of PVC inserts are included for varying glass thickness and/or door styles.

Modifications Are Not Available

Description	Model	Price
RETAINER CLIPS	RETAINER	9

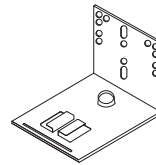

- Sold in pairs.

Modifications Are Not Available

Description	Model	Price
STEM BUMPER PADS	BUMPERSTEM	5



- Sold in quantities of 10.

Modifications Are Not Available

Description	Model	Price
HINGE SPACERS	HNGSPACER	5

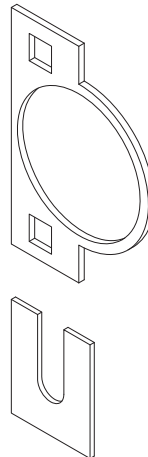

- Specify round or U-shaped.
- Round spacer fits behind hinge on door. U-shaped spacer fits behind hinge plate on face frame.

Modifications Are Not Available

Description	Model	Price
-------------	-------	-------

ROLL TRAY BUMPER PADS

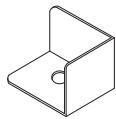

Model	Price
BUMPERTT	15

- Sold in quantities of 4.

Modifications
Are Not
Available

INSET MAGNETIC CATCHES

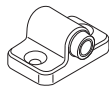

Model	Price
MAGCATCHINSET	20

- Sold individually.
- Includes strike plate.

Modifications
Are Not
Available

TURNBUCKLES for FALSE DRAWER FRONTS



Model	Price
FALSEPANELCLIP	9

Modifications
Are Not
Available

FULL EXTENSION DRAWER and ROLL TRAY SLIDES



Model	Price
DGK12FXSPG (Undermount with Smart Stop)	129

DGK15FXSPG (Undermount with Smart Stop)	129
---	-----

DGK18FXSPG (Undermount with Smart Stop)	129
---	-----

DGK21FXSPG (Undermount with Smart Stop)	129
---	-----

DGK24FXSPG (Undermount with Smart Stop)	129
---	-----

Modifications
Are Not
Available

EDGEBANDING

Model	Price
BANDVEN	6

- Veneer is unfinished.
- Price per foot.
- Minimum: 1'.
- Maximum: 10'.

Modifications
Are Not
Available

HINGES

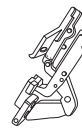

942HINGE



3/4HINGESC



32049HINGE



FOSHINGE

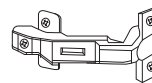

HINGE170

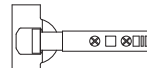

HINGEISC

HINGE ANGLE RESTRICTION CLIP



Model	Price
HINGERESCLIP	12

- Sold in pairs.
- Restricts hinges to 86° opening capability.
- Works only with 3/4HINGESC and FOSHINGE.
- Not for use with bifold hinges or 170° corner hinges.
- Not recommended for cabinets with roll trays.

Modifications
Are Not
Available

HINGE ANGLE RESTRICTION CLIP INSET



Model	Price
HINGERESCLIPIN	14

- Sold in pairs.
- Restricts hinges to 87° opening capability.
- Works only with HINGEISC. Will not work with finial hinges.
- Not for use with bifold hinges or 170° corner hinges.
- Not recommended for cabinets with roll trays.

Modifications
Are Not
Available

Code	Hinge	Where Used
942HINGE	3/4" Overlay Concealed	All 3/4" overlay units requiring a 170° hinge (requires a hinge and plate #)
3/4HINGESC	3/4" Overlay Concealed	All 3/4" overlay units that do not require a 170° hinge
32049HINGE	Bifold	All corner units (requires a hinge and plate #) 60°
FOSHINGE	1 5/16" Overlay FOL Concealed Smart Stop	All FOL units except those requiring a 170° hinge
HINGE170	Inset 170° Concealed	All Inset Units requiring a 170° inset hinge
HINGEISC	Inset Concealed Smart Stop	All Inset Units except those requiring a 170° inset hinge
SCISSORHINGE	Scissor Hinge	Used in Tilt-out Applications

- Price per pair.

Kits & Hardware

Description	Model	Price
HINGE RESTRICTION CLIP for WTH-BF and WTH-SL	WTHBF104CLIP	21
	WTHBF83CLIP	21
	WTHSL100CLIP	12
	WTHSL75CLIP	12



WTHBF104CLIP

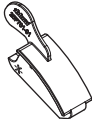

WTHBF83CLIP

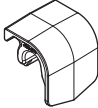

WTHSL100CLIP

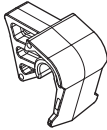

WTHSL75CLIP



- Sold in pairs.
- WTH-BF restricts hinges to 104° or 83° opening.
- WTH-SL restricts hinges to 100° or 75° opening.

Modifications
Are Not
Available

Description	Model	Price
HINGE PLATES	HINGEISCLPT1	9

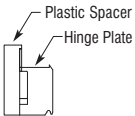
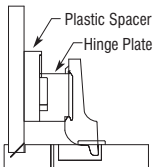

HINGEISCLPT1

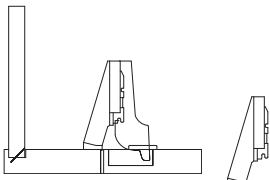

HINGEISCLPT2



- Plate attaches to the end panel.
- Plastic spacer included.
- Available on Inset and Beaded Inset Styles only.

- HINGEISCLPT2** 9
- Plate attaches to the back side of the face panel.
 - Used where Hinge Plate cannot be attached to the End Panel (i.e. Wide Stiles, Clipped Corners, etc.).
 - Available on Inset and Beaded Inset Styles only.

Modifications
Are Not
Available

Description	Model	Price
PREMIUM DOOR MECHANISM	PDM	39

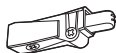

- Includes all installation hardware.
- Creates a smooth and silent self-closing motion.
- Recommended PDMs per cabinet: 1 per door on any door with 2 hinges and 2 per door on any door with 3 or more hinges.
- Additional PDMs may be required when an accessory item is attached to the cabinet door.
- Not recommended for use on bifold doors.
- Not available with finial hinges.

Modifications
Are Not
Available

Description	Model	Price
NEW INSET FINIAL HINGES	HIFAB2	27
	HIFBN2	27
	HIFMB2	27
	HIFORB2	27

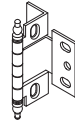

- Sold in pairs.
- Available on Inset and Beaded Inset Door Styles only.
- AB = Antique Brass, BN = Brushed Nickel, MB = Matte Black, ORB = Oil Rubbed Bronze.

Modifications
Are Not
Available

Description	Model	Price
NEW CABINET CARE KIT (PURE&SIMPLE™)	CABCLEANKIT	50



- PURE&SIMPLE™ Cabinet Care Kit includes one 16 ounce spray bottle of cleaning solution and a small microfiber cloth.
- Safe for use on wood and laminate cabinet surfaces.

Modifications
Are Not
Available

Description	Model	Price
INSTALLATION HARDWARE PARTS	BUMPERPADS*	9
	BRKOFFSCREW8/32	10

- Sold in quantities of 25.
- *Rubber bumper pads.

Modifications
Are Not
Available

Description	Model	Price
-------------	-------	-------

HARDWARE



















DECORATIVE PULLS and KNOBS

	PULLT001 • Pull - Brushed Satin Nickel • C/C: 7" L: 8" W: 3/8" P: 1 1/2"	78
	KNOBT002 • Knob - Brushed Satin Nickel • C/C: 1 1/4" L: 2" W: 3/8" P: 1 1/2"	37
	KNOBT013 • Knob - Tuscan Bronze • D: 1 1/4" P: 1 1/16"	44
	 KNOBRH20 • Rustic Knob - Bronze Highlight • L: 1 7/16" W: 1 7/16" P: 1 3/32"	30
	PULLRH21 • C/C: 3"	12
	PULLH50 • Pull - Satin Nickel • C/C: 5" L: 5" W: 5/16" P: 1 1/4"	46
	PULLH63 • Pull - Satin Nickel • C/C: 96mm L: 4 1/8" W: 1/2" P: 1 1/16"	39
	KNOBH100 • Acrylic Knob with Satin Nickel base • D: 1 3/8" P: 1 3/8" B: 3/4"	28
	PULLH105 • 1.75" Tab Pull - Satin Nickel • C/C: 1" L: 1 3/4" W: 1" P: 1 3/4"	28
	PULLH106 • 7" Tab Pull - Satin Nickel • C/C: 160mm L: 7" W: 1" P: 1 3/4"	43
	PULLH107 • 12" Tab Pull - Satin Nickel • C/C: 12" L: 13" W: 1" P: 1 13/16"	71
	KNOBH108 • Contemporary Knob - Iced Tea Nickel • L: 1 7/16" W: 1 1/16" P: 1" B: 1/2"	30
	PULLH115 • 128mm SP Pull - Black Mist • C/C: 128mm L: 6 3/8" W: 1/2" P: 1"	28
	KNOBH116 • SP Square Knob - Black Mist • L: 1 5/16" W: 1 1/4" P: 1 1/8" B: 3/8"	27
	KNOBH117 • 1.32" Knob - Refined Bronze • L: 1 5/16" W: 1 5/16" P: 1 3/16" B: 7/8"	30

D = Diameter
P = Projection (Hardware Depth)
L = Length
W = Width
B = Base
C/C = Center to Center

















Description	Model	Price
-------------	-------	-------

DECORATIVE PULLS and KNOBS (cont'd)

	KNOBH118 • 1.32" Knob - Satin Nickel • L: 1 5/16" W: 1 5/16" P: 1 3/16" B: 7/8"	30
	PULLH119 • 160mm Pull - Refined Bronze • C/C: 160mm L: 7 1/8" W: 3/4" P: 1"	41
	PULLH120 • 160 Pull - Satin Nickel • C/C: 160mm L: 7 1/8" W: 3/4" P: 1"	41
	PULLH122 • Pull - Satin Nickel • C/C: 12" L: 12 3/4" W: 7/8" P: 1 3/16"	62
	KNOBH127 • 1.5" Round Knob - Silver Stone • D: 1 1/2" P: 1" B: 7/8"	28
	PULLH128 • 160mm Pull - Silver Stone • C/C: 160mm L: 7 1/2" W: 3/4" P: 1 1/16"	38
	PULLH129 • Pull - Stainless Steel • C/C: 128mm L: 6 3/8" W: 7/16" P: 1 1/8"	28
	PULLH130 • Pull - Oil-Rubbed Bronze • C/C: 128mm L: 6 3/8" W: 7/16" P: 1 1/8"	28
	PULLH131 • Pull - Stainless Steel • C/C: 224mm L: 10" W: 1/2" P: 1 3/8"	33
	PULLH132 • Pull - Oil-Rubbed Bronze • C/C: 224mm L: 10" W: 1/2" P: 1 3/8"	33
	KNOBH135 • Knob - Stainless Steel • L: 1 3/4" W: 1/2" P: 1 1/8" B: 1/2"	30
	KNOBH136 • Knob - Oil-Rubbed Bronze • L: 1 3/4" W: 1/2" P: 1 1/8" B: 1/2"	30
	PULLH141 • Pull - Stainless Steel • C/C: 128mm L: 7 3/8" W: 1/2" P: 1 1/4"	27
	PULLH142 • Pull - Stainless Steel • C/C: 192mm L: 9 15/16" W: 1/2" P: 1 1/4"	28
	PULLH143 • Pull - Stainless Steel • C/C: 384mm L: 17 1/2" W: 1/2" P: 1 1/4"	34
	PULLH144 • 160 mm Pull - Iced Tea Nickel • C/C: 160mm L: 6 5/16" W: 9/16" P: 1 1/16"	32
	KNOBM148 • Knob - Antique Pewter • L: 2 5/8" W: 5/8" P: 1 1/4"	45
	KNOBM206 • Knob - Antique Pewter • D: 1 1/4" P: 1 1/16"	44

Kits & Hardware

Description	Model	Price
DECORATIVE PULLS and KNOBS (cont'd)		
	KNOBM207 • Knob - Rust • D: 1 1/4" P: 1 1/16"	45
	PULLM364 • Pull - Antique Pewter • C/C: 3" L: 4 5/8" W: 1 7/16" P: 15/16"	50
	PULLM381 • Pull - Brushed Satin Nickel • C/C: 5 1/16" L: 6" W: 1/2" P: 1 1/16"	29
	PULLM383 • Pull - Brushed Matte Black • C/C: 5 1/16" L: 6" W: 1/2" P: 1 1/16"	29
	PULLM430 • Pull - Satin Nickel • C/C: 5 1/16" L: 7" W: 15/32" P: 1 7/16"	33
	PULLM475 • Pull - Antique Pewter • C/C: 3 3/4" L: 5" W: 9/16" P: 1"	37
	PULLM476 • Pull - Rust • C/C: 3 3/4" L: 5" W: 9/16" P: 1"	37
	KNOBM549 • Knob - Brushed Satin Nickel • D: 7/8" P: 1"	26
	PULLM570 • Pull - Brushed Satin Nickel • C/C: 5 1/16" L: 5 7/8" W: 1/2" P: 1 3/16"	34
	PULLH911 • Pull - Hammered Blackened Bronze • C/C: 3" L: 5-5/8" W: 1" P: 1 1/4"	36
	KNOBH913 • Knob - Blackened Bronze • 1 3/8"	39
	KNOBH951 • Knob - Blackened Bronze • L: 1 3/4" W: 1" P: 1" B: 1 1/16" x 1/2"	30
	PULLH952 • Labeled Secretary Pull - Blackened Bronze • C/C: 3" L: 4 1/4" W: 1 1/2" P: 11/16"	42
	PULLH957 • Labeled Secretary Pull - Satin Nickel • C/C: 3" L: 4 1/4" W: 1 1/2" P: 11/16"	41
	PULLT1015 • Pull - Black • C/C: 7" L: 8" W: 11/16" P: 1 1/2"	75

Description	Model	Price
DECORATIVE PULLS and KNOBS (cont'd)		
	KNOBT1017 • Knob - Black • C/C: 1 1/4" L: 2" W: 11/16" P: 1 1/4"	35
	PULLT1018 • Pull - Tuscan Bronze • C/C: 5 1/16" L: 6" W: 1/2" P: 1 1/16"	27
	KNOB1420 • Knob - Satin Nickel • D: 1 1/4" P: 1 1/8"	24
	PULLM1674 • Pull - Tuscan Bronze • C/C: 3" L: 4 5/8" W: 1 7/16" P: 15/16"	49
	KNOBM1820 • Knob - Cast Iron • L: 1 5/16" W: 1 5/16" P: 1"	41
	PULLM1823 • Pull - Cast Iron • C/C: 5 1/16" L: 7 3/8" W: 1" P: 1 1/4"	61
	KNOB1901 • Knob - Black Iron • L: 1 7/16" W: 1 1/4" P: 1 1/8" B: 15/16"	27
	PULL1902 • Pull - Black Iron • C/C: 128mm L: 6 1/3" W: 1 1/10" P: 1 1/16"	39
	PULL1904 • Pull - Chrome • C/C: 3 3/4" L: 5 1/4" W: 1" P: 1"	56
	PULL1905 • Pull - Chrome • C/C: 128mm L: 6 3/8" W: 9/16" P: 1"	54
	KNOB1906 • Knob - Chrome • L: 1 1/16" W: 1 1/16" P: 1 1/8" B: 3/8"	40
	PULL1907 • Pull - Gold • C/C: 160mm L: 6 7/10" W: 2/5" P: 1 1/5"	49
	KNOB1908 • Knob - Gold • L: 1 1/4" W: 1 1/4" P: 1" B: 3/8"	30
	KNOB1909 • Knob - Champagne Bronze • L: 1 1/4" W: 1 1/4" P: 1 1/8" B: 3/4"	29
	PULL1910 • Pull - Champagne Bronze • C/C: 224mm L: 9 9/16" W: 3/4" P: 1 5/16"	61
	PULL1911 • Pull - Champagne Bronze • C/C: 192mm L: 8 3/8" W: 3/4" P: 1 1/4"	54
	KNOB1912 • Knob - Black • D: 1 1/4" P: 1 13/16"	40

D = Diameter
P = Projection (Hardware Depth)
L = Length
W = Width
B = Base
C/C = Center to Center

Description	Model	Price
FACTORY INSTALLED LIGHTING		

STANDARD DRIVERS

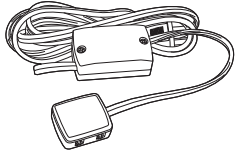

STAND1264

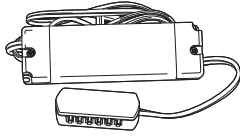

**STAND123012
STAND126012**

STAND1264	130
STAND123012	303
STAND126012	514

- Minimum of one driver is required for each continuous cabinet run with lighting.
- To determine driver requirements, calculate the total wattage of each cabinet run and select the appropriate size driver(s).
- Driver plugs into a standard 110 volt outlet and converts down to 12 volts to power all LED lighting components installed in cabinets.

Code	Voltage	Wattage (Max Load)	Connector Ports
STAND1264	12	6	4
STAND123012	12	30	12
STAND126012	12	60	12

Modifications
Are Not
Available

POWER BRIDGE

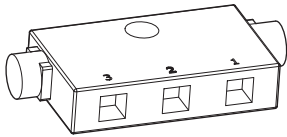

3ZONEPWRBRDG	71
---------------------	----

- Allows for a non-controlled application and zoned application.
- Non-controlled: connects the Driver and Cabinet Bridge.
- Zoned: connects the Cabinet Bridge, Receiver, and Driver.

Modifications
Are Not
Available

4 ZONE DIMMING RECEIVER

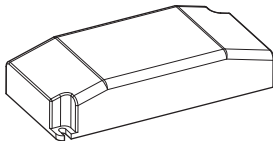

4ZONEDIMREC	328
--------------------	-----

- Allows the installed LED lighting to be controlled via wireless remote (not included).
- Connects the Driver and Power Bridge.
- Controls up to four zones.

Modifications
Are Not
Available

Description	Model	Price
4 ZONE WALL CONTROLLER	4ZONECON	228

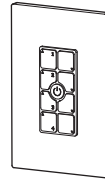

- Allows for wireless control of zoned lighting.

Modifications
Are Not
Available

JUMPER CABLES

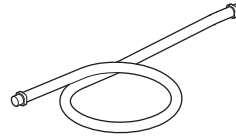

BRIDGECABLE18	52
BRIDGECABLE36	60
BRIDGECABLE72	78

- Transfers power between Cabinet Bridges.
- Cable plugs into end of each Bridge.
- Available in 18", 36" and 72" lengths.
- Can be combined for longer lengths.

Modifications
Are Not
Available

*Interior lighting is 5000K cool white hue. Interior lighting and exterior cool lighting are not available in California.

Lighting

Modifications for Factory Installed Lighting

	Wall	Base	Tall	Filler	Panel	
Position Bridge on Top of Wall Cabinet	0	N/A	N/A	N/A	N/A	per cabinet

Specify BRIDGE.TOP

On any wall cabinet with a lighting modification attached, the bridge will be factory installed on top of the cabinet.

Position Bridge on Bottom of Wall Cabinet	0	N/A	N/A	N/A	N/A	per cabinet
--	---	-----	-----	-----	-----	-------------

Specify BRIDGE.BTM

On any wall cabinet with a lighting modification attached, the bridge will be factory installed on bottom of the cabinet.

Add Interior Light to Single Opening Wall Cabinet or Corner Base Cabinet

Specify INT.LGT (Single Opening Wall Cabinet) or INT.LGT.BC (Corner Base Cabinet)

- Bridge unit comes installed on wall cabinets. Select appropriate modification for top or bottom installation.
- Battery Pack included with corner base cabinets.
- All wiring is connected to the bridge from each light strip.

INT.LGT	400	N/A	N/A	N/A	N/A	per cabinet
---------	-----	-----	-----	-----	-----	-------------

- Wall cabinets 9" to 39" wide only.

INT.LGT	635	N/A	N/A	N/A	N/A	per cabinet
---------	-----	-----	-----	-----	-----	-------------

- Wall cabinets 42" wide and above.

INT.LGT.BC	N/A	470	N/A	N/A	N/A	per cabinet
------------	-----	-----	-----	-----	-----	-------------

- Corner Base Cabinet.

Add Interior Light to All Openings of Cabinet

Specify INT.ALL.LGT

- Includes stacked wall cabinets and utility cabinets.
- Bridge unit comes installed on cabinets. Select appropriate modification for top or bottom installation.
- All wiring is connected to the bridge from each light strip.

	400	N/A	400	N/A	N/A	per opening
--	-----	-----	-----	-----	-----	-------------

- Price listed is per opening.
- Wall cabinets 9" to 39" wide only.

	635	N/A	N/A	N/A	N/A	per opening
--	-----	-----	-----	-----	-----	-------------

- Price listed is per opening.
- Wall cabinets 42" wide and above.

Add Interior Light to Top Opening of Cabinet

Specify INT.TOP.LGT

- Includes stacked wall cabinets and utility cabinets.
- Bridge unit comes installed on cabinets. Select appropriate modification for top or bottom installation.
- All wiring is connected to the bridge from each light strip.

	400	N/A	400	N/A	N/A	per cabinet
--	-----	-----	-----	-----	-----	-------------

- Wall cabinets 9" to 39" wide only.

	635	N/A	N/A	N/A	N/A	per cabinet
--	-----	-----	-----	-----	-----	-------------

- Wall cabinets 42" wide and above.

Add Interior Light to Middle Opening of Cabinet

Specify INT.MID.LGT

- Includes stacked wall cabinets and utility cabinets.
- Bridge unit comes installed on cabinets. Select appropriate modification for top or bottom installation.
- All wiring is connected to the bridge from each light strip.

	400	N/A	400	N/A	N/A	per cabinet
--	-----	-----	-----	-----	-----	-------------

- Wall cabinets 9" to 39" wide only.

	635	N/A	N/A	N/A	N/A	per cabinet
--	-----	-----	-----	-----	-----	-------------

- Wall cabinets 42" wide and above.

*Interior lighting is 5000K cool white hue. Interior lighting and exterior cool lighting are not available in California.

Modifications for Factory Installed Lighting (cont'd)

Add Interior Light to Bottom Opening of Cabinet

Specify INT.BTM.LGT

- Bridge unit comes installed on wall cabinets. Select appropriate modification for top or bottom installation.
- All wiring is connected to the bridge from each light strip.

Wall	Base	Tall	Filler	Panel	
400	N/A	400	N/A	N/A	per cabinet

- Wall cabinets 9" to 39" wide only.

635	N/A	N/A	N/A	N/A	per cabinet
-----	-----	-----	-----	-----	-------------

- Wall cabinets 42" wide and above.

Add Interior Light to Top and Middle Openings of Cabinet

Specify INT.TOP.MID.LGT

- Bridge unit comes installed on wall cabinets. Select appropriate modification for top or bottom installation.
- All wiring is connected to the bridge from each light strip.

795	N/A	795	N/A	N/A	per cabinet
-----	-----	-----	-----	-----	-------------

- Wall cabinets 9" to 39" wide only.

1260	N/A	N/A	N/A	N/A	per cabinet
------	-----	-----	-----	-----	-------------

- Wall cabinets 42" wide and above.

Add Interior Light to Top and Bottom Openings of Cabinet

Specify INT.TOP.BTM.LGT

- Bridge unit comes installed on wall cabinets. Select appropriate modification for top or bottom installation.
- All wiring is connected to the bridge from each light strip.

795	N/A	795	N/A	N/A	per cabinet
-----	-----	-----	-----	-----	-------------

- Wall cabinets 9" to 39" wide only.

1260	N/A	N/A	N/A	N/A	per cabinet
------	-----	-----	-----	-----	-------------

- Wall cabinets 42" wide and above.

Add Interior Light to Middle and Bottom Openings of Cabinet

Specify INT.MID.BTM.LGT

- Bridge unit comes installed on wall cabinets. Select appropriate modification for top or bottom installation.
- All wiring is connected to the bridge from each light strip.

795	N/A	795	N/A	N/A	per cabinet
-----	-----	-----	-----	-----	-------------

- Wall cabinets 9" to 39" wide only.

1260	N/A	N/A	N/A	N/A	per cabinet
------	-----	-----	-----	-----	-------------

- Wall cabinets 42" wide and above.

Add Exterior Cool Light to Bottom of Wall Cabinet

Specify EXT.BTM.LGT.C

- LED light strip housed in a rigid aluminum extrusion.
- 5000K cool white hue.
- Installed 9" from back of cabinet.

285	N/A	N/A	N/A	N/A	per cabinet
-----	-----	-----	-----	-----	-------------

Add Exterior Warm Light to Bottom of Wall Cabinet

Specify EXT.BTM.LGT.W

- LED light strip housed in a rigid aluminum extrusion.
- 3000K warm white hue.
- Installed 9" from back of cabinet.

285	N/A	N/A	N/A	N/A	per cabinet
-----	-----	-----	-----	-----	-------------

*Interior lighting is 5000K cool white hue. Interior lighting and exterior cool lighting are not available in California.

Notes

HEARTH1

HE01	Parts List
✓	(1) 2-WSP930, EXBKL & R6", FTK, FPEL, FPER
✓	(2) 1-BBM8
✓	(3) 1-RPV48
✓	(4) 1-SHELFM1 19" x 67", trim front with 2-CBEADM
✓	(5) 2-SWVCRM8
✓	(6) 1-SHELFM1 22" x 73", trim front with 2-CBEADM
✓	(7) 1-W3321, ID21
✓	(8) 1-W3321, ID21, Half Width 16.5R, FPEL
✓	(9) 1-W3321, ID21, Half Width 16.5L, FPER
✓	(10) 2-SM8

NOTE: Moulding needs to be ordered to match kitchen. See appliance specs for clearance requirements. Vent installation behind valance recommended. Not available in Walnut. Use single design code HE01 to locate template in 20/20 catalog. You may edit these designs to accommodate actual dimensions in your projects.

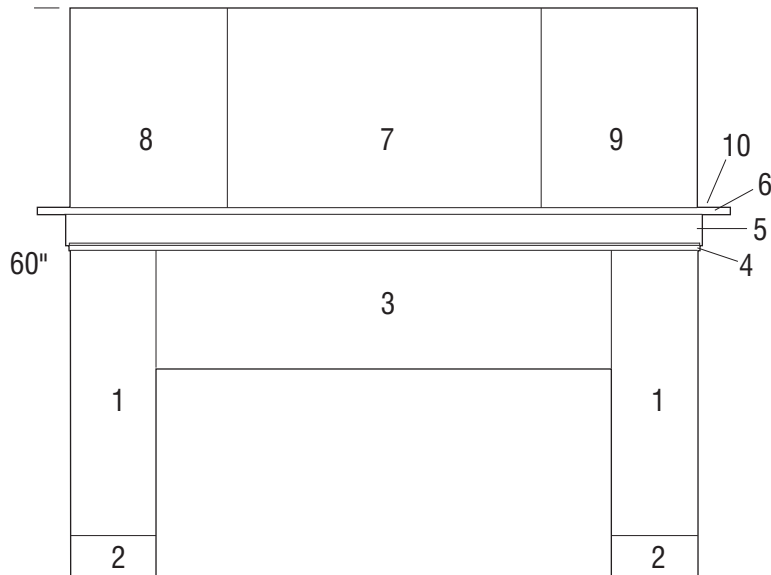
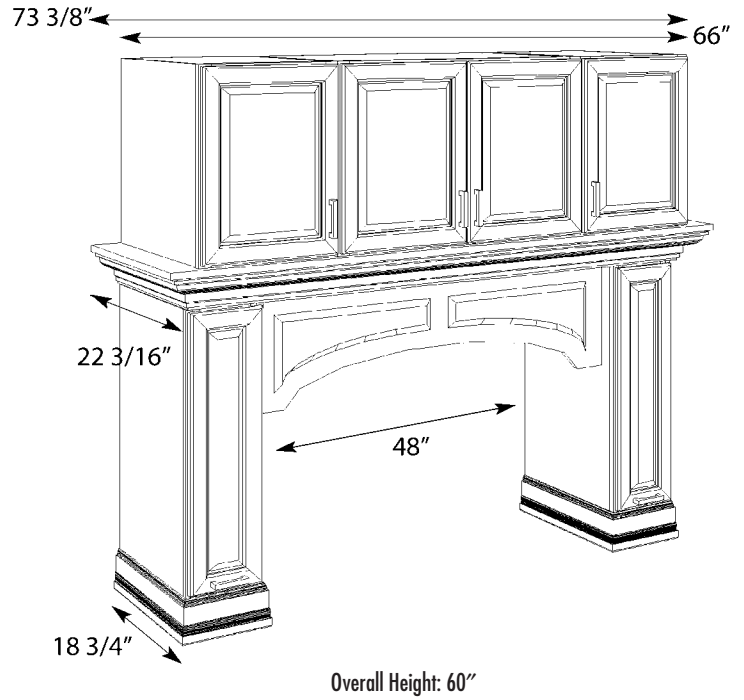

Parts Key
(Aerial View)

Distinctions

HEARTH2

HE02	Parts List
✓	(1) 2-PILB84BAT w/TBATM Moulding (trim to 15 3/4" x 60" H)
✓	(2) 1-WSP936, EXBKR3", FPER
✓	(3) 1-WSP936, EXBKL3", FPEL
✓	(4) 1-RPV48
✓	(5) 1-W3318, ID15
✓	(6) 1-W3318, Half Width 16.5"R, ID15
✓	(7) 1-W3318, Half Width 16.5"L, ID15

NOTE: Moulding needs to be ordered to match kitchen. See appliance specs for clearance requirements. Not available in Walnut.

Use single design code HE02 to locate template in 20/20 catalog. You may edit these designs to accommodate actual dimensions in your projects.

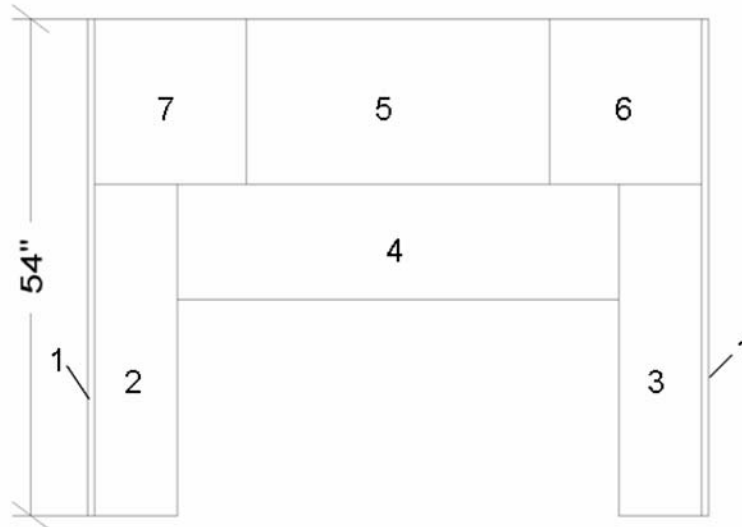
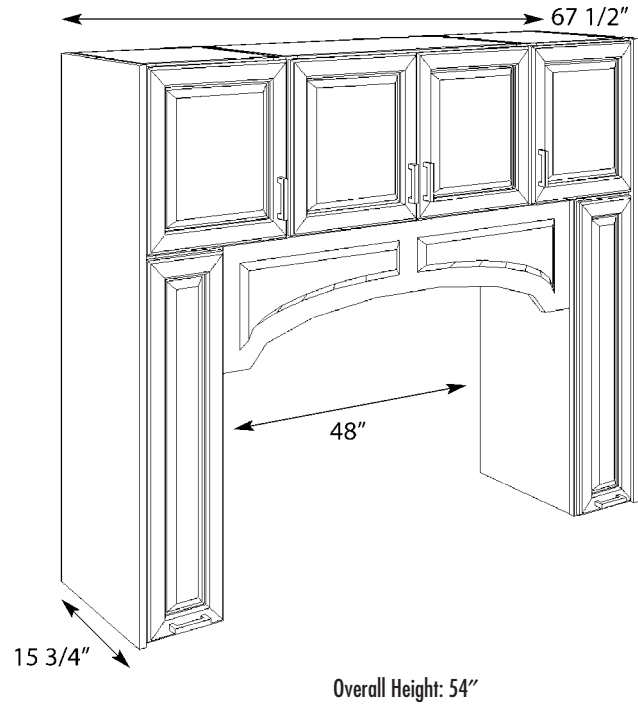

Parts Key
(Aerial View)

ARMOIREI

ARO1FO Full Overlay	Parts List
✓	(1) V33024BCFP FLUT3
✓	(2) VB363021 – 18" Deep EXL1/4", EXR1/4", FTK, MIP
✓	(3) V33024BCFP FLUT3
✓	(4) W360BCFP 27" Deep, FLUT3
✓	(5) W3618 ID18", EXL1/4", EXR1/4", MIP
✓	(6) W3636 MD36, MIP*, ID18", EXL1/4", EXR1/4"
✓	(7) 3/4SOLID 3/4" x 6" x 36 1/2"
✓	(8) W360BCFP 27" Deep, FLUT3
✓	(9) WOODTOP – 1 1/2" x 19 1/2" Deep x 43 1/2" #17 F, L, R
✓	(10) 2-ACO
✓	(11) ACOVLY
✓	(12) 2-TF396 FTK
✓	(13) 2-TSTM
✓	(14) 2-MTCROWN8
✓	(15) 2-BSM

ARO1FO

Mount W3636 on top of W3618. Place 3/4SOLID 3/4" x 6" x 36 1/2" on top of W3636. Attach ACOVLY to center of filler. Use W360BCFP cut to 19" deep on each side of stacked wall cabinets. Attach ACO to tops of columns. Use wood top as countertop. Attach V33024BCFP cut to fit on each side of VB363021. Wrap BSM around entire unit. Construct top trim with TF396 FTK between TSTM and MTCROWN8.

NOTE: Glass not included. Not available in Brooks, Daxton, Langley, and Tackett. Not available in Walnut.
 *When a decorative door option is chosen in 20/20, Matching Interior Plywood (MIP) is a preselected option. If MIP is not desired, it can be deselected by choosing NOTMIP.

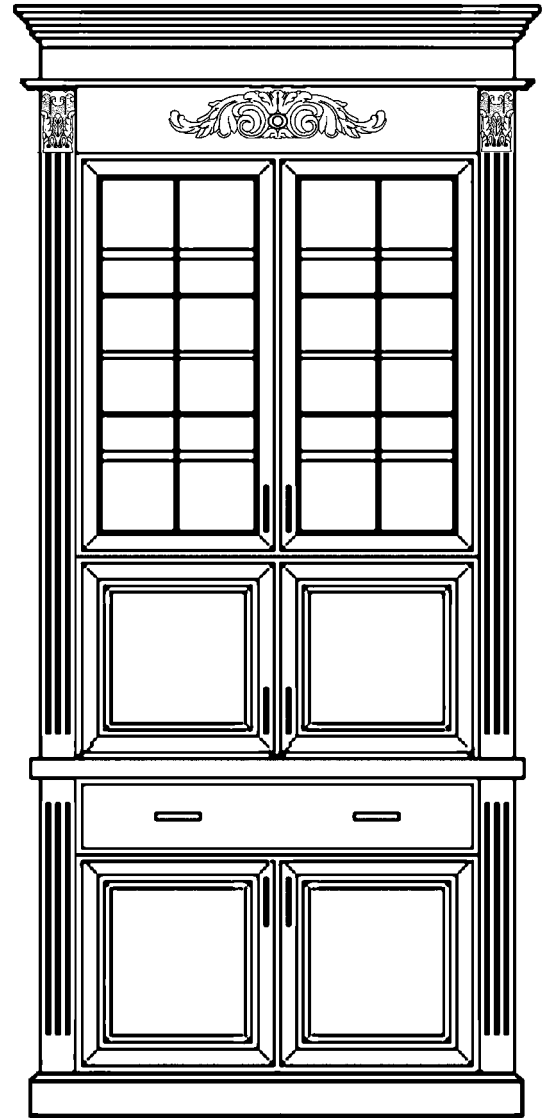

Overall Height: 97 1/8"
(including moulding shown)

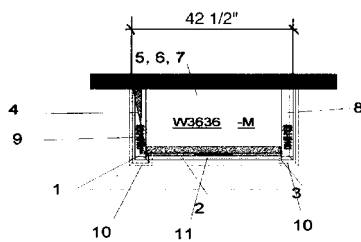

Full Overlay Parts Key
(Aerial View)

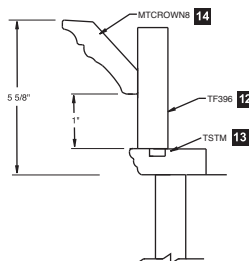

Top Trim

Distinctions

ARMOIRE3

AR03FO Full Overlay	Parts List
✓	⁽¹⁾ W2730, A2DRW, FPEL, FPER, AUTHB, FTKAV, 2WSL1.5, F, TW, XTW, HW, XHW2WSR1.5, ID18", MIP
✓	⁽²⁾ W2718 ID18", ADRW, AUTHB, FPEL, FPER, 2WSL1.5, F, TW, XTW, HW, XHW2WSR1.5, MIP
✓	⁽³⁾ WOODTOP 1 1/2"H x 19 1/4"D x 29"W #17 F, L, R
✓	⁽⁴⁾ WOODTOP 1 1/2"H x 19 1/4"D x 29"W #17 F, L, R
✓	⁽⁵⁾ 2-CBEADM

AR03FO

Place 1 - WOODTOP on top of each cabinet. Place upper wood top finished side down. Attach CBEADM moulding vertically on exposed face frame of both cabinets.

NOTE: Not available in Walnut.

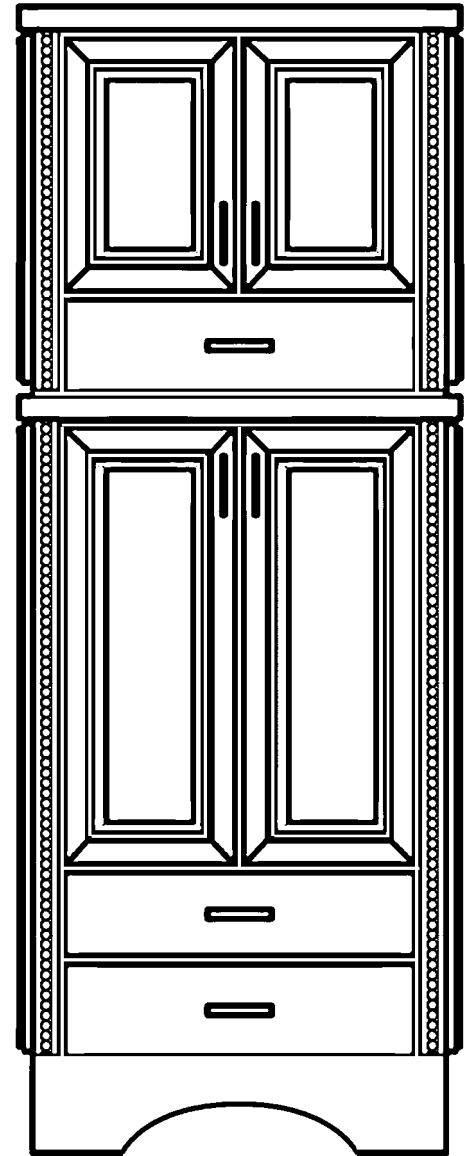

Overall Height: 73 1/2"

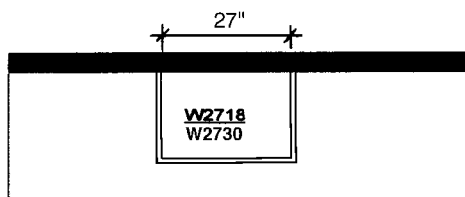

Parts Key
(Aerial View)

ARMOIRE4

ARO4FO Full Overlay	Parts List
✓	(1) 6DB42 OBRB, EXL1/4", EXR1/4"
✓	(2) WOODTOP 1 1/2"H x 25 1/4"D x 45"W #17 F, L, R
✓	(3) AD42
✓	(4) AD42
✓	(5) W4236 ID18", MIP*, 2-PRMD36, EXL1/4", EXR1/4"
✓	(6) W4212 ID18", EXL1/4", EXR1/4", MIP
✓	(7) PILB34.5BAT, w/TBEM
✓	(8) PILB34.5BAT, w/TBEM
✓	(9) PILB84BAT, w/TBEM
✓	(10) PILB84BAT w/TBEM
✓	(11) 2-SHKRCRM8
✓	(12) 1-PIL584BAT w/TBEM
✓	(13) 1-FF330

ARO4FO

Attach pilasters to sides of all cabinets. Cut to fit. Pull AD42s out 6". Top trim is SHKRCRM8 cleated to PIL584BAT w/TBEM. Trim filler to 1/4" and install on each side of AD42s.

NOTE: Glass not included. Not available in Brooks, Brooks Beaded Inset, Brooks Inset, Daxton, Daxton Beaded Inset, Daxton Inset, Wells, Langley, Langley Beaded Inset, Langley Inset, Trystan, Trystan Beaded Inset, Trystan Inset, Tackett, Tackett Beaded Inset, Tackett Inset, Vesta Beaded Inset, and Vesta Inset. Not available in Walnut.

*When a decorative door option is chosen in 20/20, Matching Interior Plywood (MIP) is a preselected option. If MIP is not desired, it can be deselected by choosing NOTMIP.

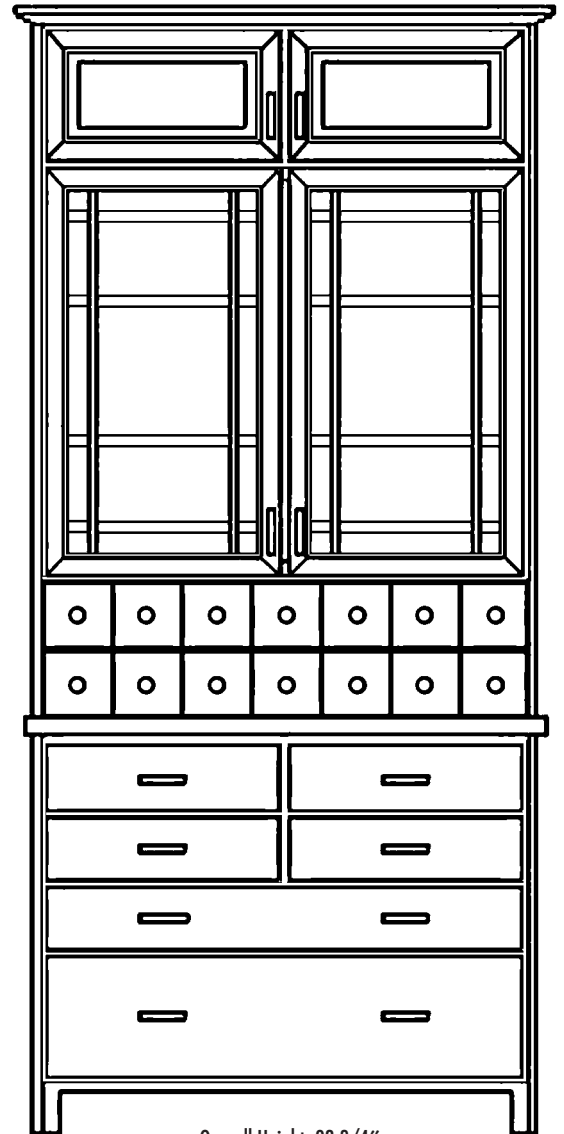

Overall Height: 98 3/4"
(including moulding shown)

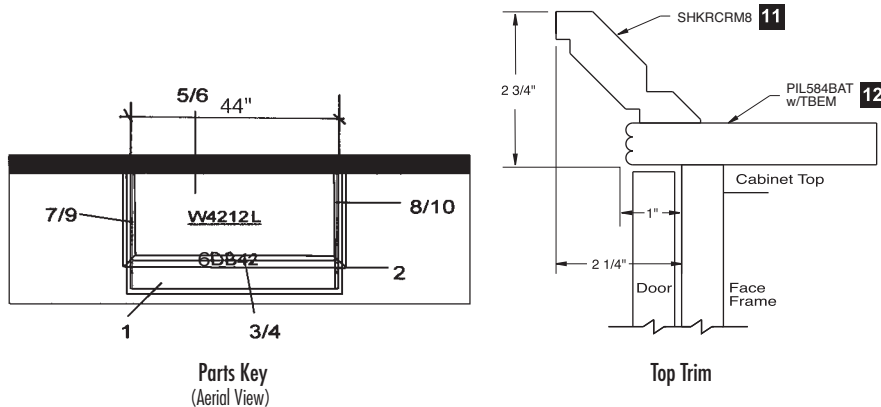

Distinctions

ARMOIRE5

ARO5FO Full Overlay	Parts List
✓	(1) B334.527BCFP ROSFLUT
✓	(2) BOB18AV EXL1/4"
✓	(3) BOB18AV EXR1/4"
✓	(4) B334.527BCFP ROSFLUT
✓	(5) W360BCFP 24"D, ROSFLUT
✓	(6) W3624 ID18", CND, MIP, A2DRW, EXL1/4", EXR1/4"
✓	(7) W3624 ID18", EXL1/4", EXR1/4", MIP
✓	(8) W360BCFP 24"D, ROSFLUT
✓	(9) WOODTOP 1 1/2"H x 25 1/2"D x 43 1/2" #17 F, L, R
✓	(10) 8-ROSETTEFLW
✓	(11) 1-TF396 FTK
✓	(12) 1-TSTM
✓	(13) 1-SWVCRM8
✓	(15) 1-TB8WD14

ARO5FO

Attach ROSETTEFLW to top and bottom of box columns. Cut wall box columns (W360BCFP) to 19" depth. Cut base box columns (B334.527BCFP) to 25" depth.

Top Trim — TF396 FTK between TSTM and SWVCRM8.

NOTE: Not available in Walnut.

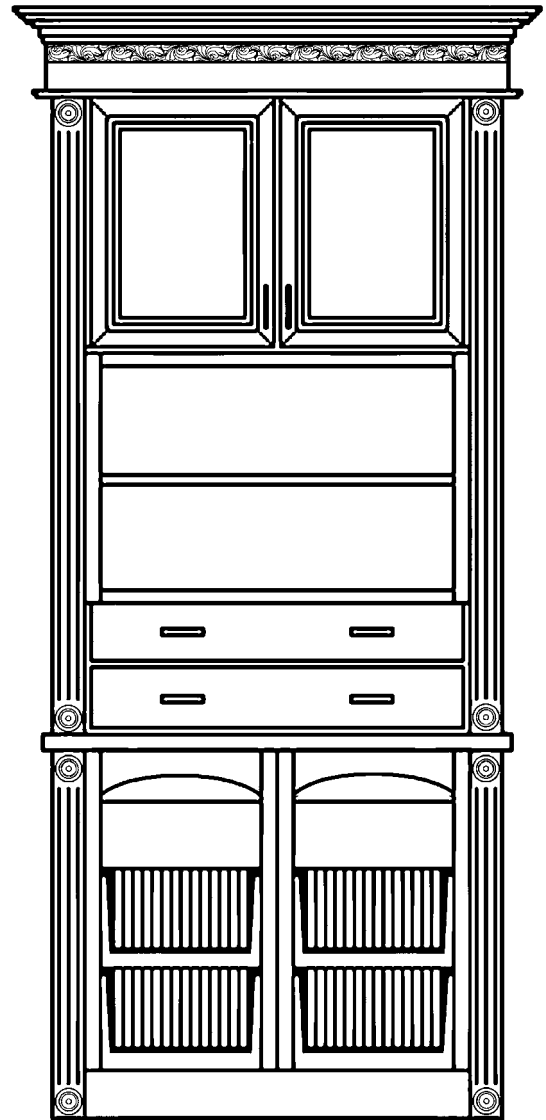

Overall Height: 101 9/16"
(including moulding shown)

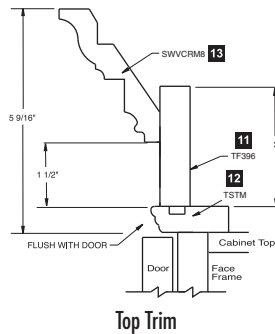
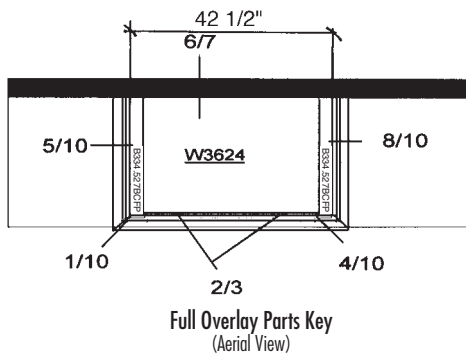

ISLAND1

ISO1FO Full Overlay	Parts List
✓	(1) DISLEGSQ
✓	(2) BWB18 FPER
✓	(3) B30FH RD18" w/2-RT30, EXL1/4", EXR1/4"
✓	(4) B18-R FPEL, FPER
✓	(5) DISLEGSQ
✓	(6) WB36 RD6", FPEL, FPER, FTKAV
✓	(7) DISLEGSQ
✓	(8) TD18FH-L FPEL
✓	(9) B30FH EXL1/4", EXR1/4"
✓	(10) 3DB18BB FPEL, FPER
✓	(11) DISLEGSQ
✓	(12) WB36 RD6", FPEL, FPER, FTKAV, CND, MIP
✓	(13) 3-TB8WD14

ISO1FO

Silicone legs in place under countertop, centered in available space.

NOTE: Not available in Walnut.

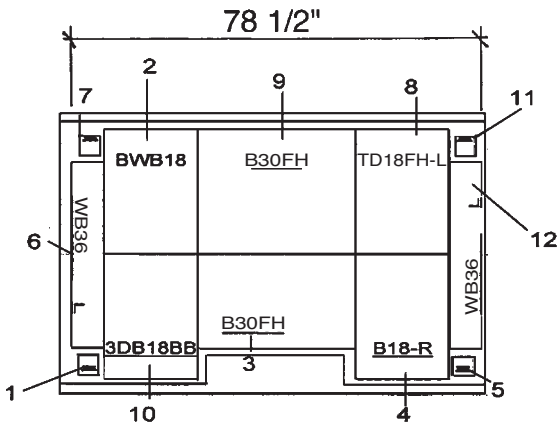
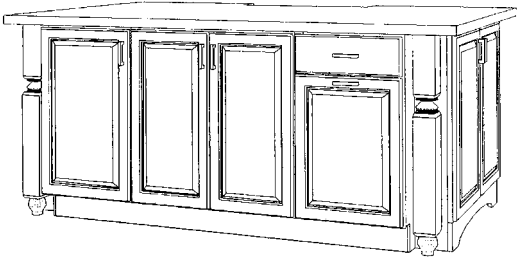
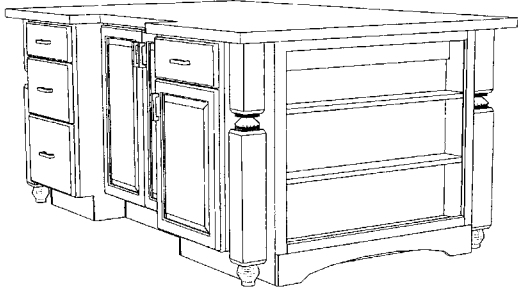
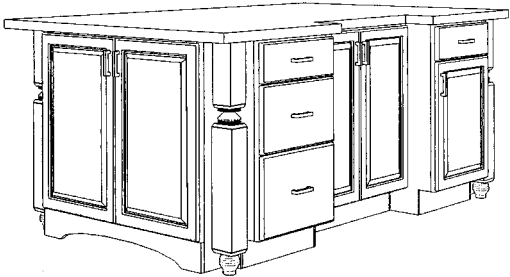

Full Overlay Parts Key
(Aerial View)

Distinctions

ENTERTAINMENT CENTER 1

EC01FO Full Overlay	Parts List
✓	(1) T68427BCFP FLUT3
✓	(2) B18-L FTK, EXL1/4", MIP
✓	(3) 3DB36 FTK
✓	(4) B18-R FTK, EXR1/4", MIP
✓	(5) W1836-L, CG ID24", MIP*, FPER, A2DRW, EXL1/4"
✓	(6) W3612 ID24", PFINBTMB, MIP
✓	(7) W1836-R, CG ID24", MI, FPEL, A2DRW, EXR1/4"
✓	(8) T68427BCFP FLUT3
✓	(9) WOODTOP – 1 1/2"H x 25 1/4"D x 72 1/2"W #17 F, L, R
✓	(10) 2-TF396 FTK
✓	(11) 2-SWVCRM8
✓	(12) 2-BRAIDM
✓	(13) 2-BSM

EC01FO

Top Trim – SWVCRM8 with BRAIDM in insert (cleat to TF396).

Baseboard – BSM (return into wall). 1/4" panel sent separately to be applied to W3612 for finished bottom.

NOTE: Glass not included. Open space for television: 36"W x 36"H x 22 1/2"D. Not available in Walnut.

*When a decorative door option is chosen in 20/20, Matching Interior Plywood (MIP) is a preselected option. If MIP is not desired, it can be deselected by choosing NOTMIP.

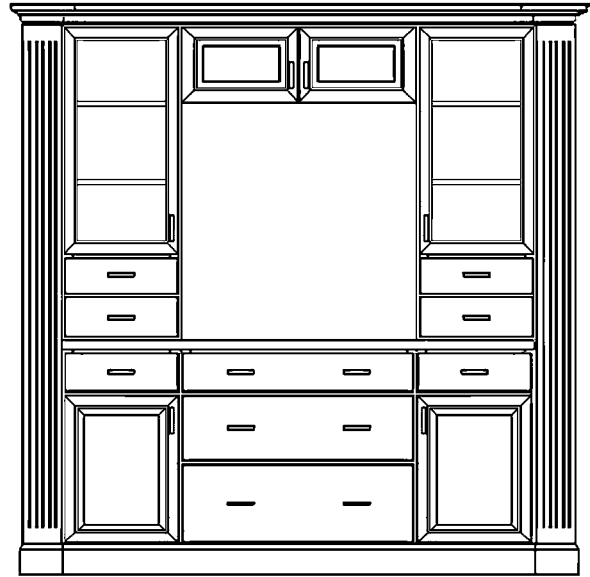

Overall Height: 87 5/16"
(including moulding shown)

Not available in Langley.

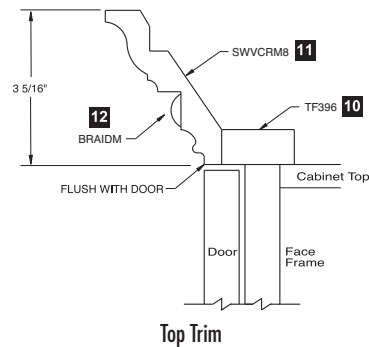
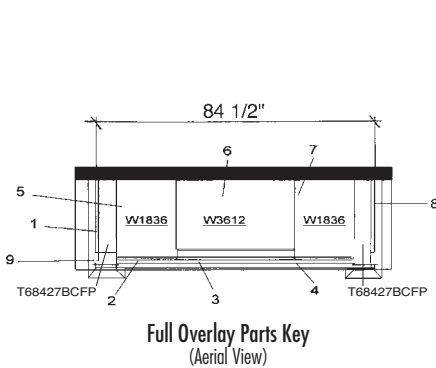

ENTERTAINMENT CENTER 2

ECO2FO Full Overlay	Parts List
✓	(1) UB1596RT-L FPEL, AUTHL, FTK, MIP
✓	(2) T39627BCFP
✓	(3) SHELFMI 3/4"H x 24"D x 60 1/2"W
✓	(4) SHELFMI 3/4"H x 24"D x 60 1/2"W
✓	(5) W301524 PFINBTMB, EXL1/4", MIP
✓	(6) W301524 PFINBTMB, EXR1/4", MIP
✓	(7) T39627BCFP
✓	(8) UB1596-R FPER, AUTHR, FTK, MIP
✓	(9) SV61
✓	(10) TF684 Finish 1 long edge
✓	(11) 2-SPRINGEND
✓	(12) 2-SPRINGROPE96
✓	(16) 3-TF396 FTK
✓	(17) 3-TSTM
✓	(18) 3-SWLCRM8
✓	(19) 3-MDENTIL8
✓	(20) 1-BP7234.5WD
✓	(21) 1-BSM
✓	(22) 1-ICM8

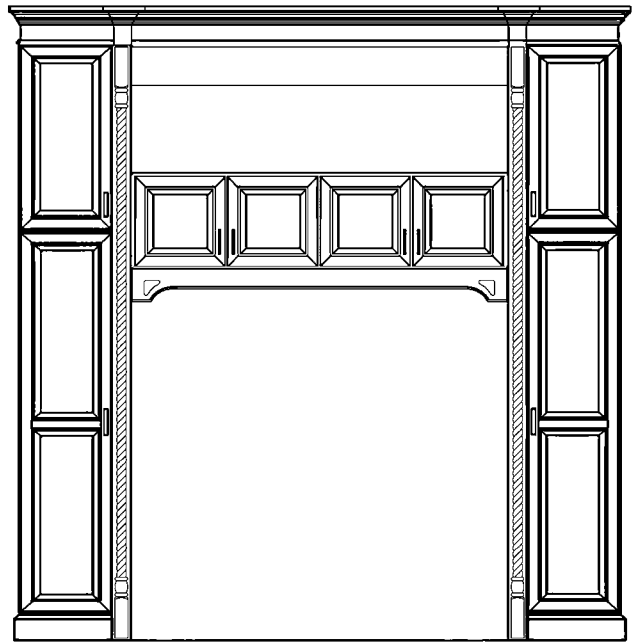

Overall Height: 100 1/16"
(including moulding shown)

Not available in Langley.

ECO2FO

Attach SPRINGEND and SPRINGROPE96 to T39627BCFP. Panel back of open shelf area with BP7234.5WD. Use ICM8 at corners of panel if needed. Cut SV61 to 60 1/2".

Top Trim – TF396 FTK between TSTM and SWLCRM8. Place MDENTIL8 under SWLCRM8. Wrap BSM around utility base. 1/4" panel sent separately to be applied to W301524 for finished bottom.

NOTE: Glass not included. Open Space for Television: 54 7/8"W x 60 1/2"H x 22 1/2"D.
Not available in Walnut.

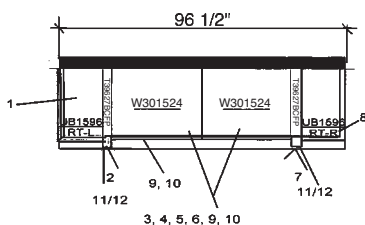

Full Overlay Parts Key
(Aerial View)

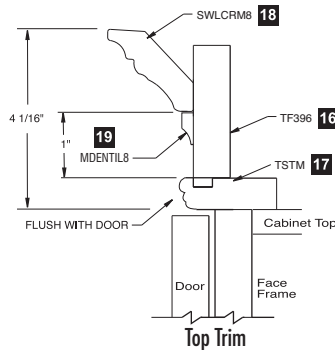

Distinctions

ENTERTAINMENT CENTER 3

ECO3FO Full Overlay	Parts List
✓	(1) T248412BCAV ID18", TVRVV, FPEL
✓	(2) B36RT FTK, EXL1/4", EXR1/4", MIP
✓	(3) T248412BCAV ID18", TVRVV, FPER
✓	(4) W3636 ID24", MIP, CND, EXL1/4", EXR1/4"
✓	(5) W362124 EXL1/4", EXR1/4", MIP
✓	(6) PILB96BAT w/MROPE
✓	(7) PILB96BAT w/MROPE
✓	(8) 3-TF396 FTK
✓	(9) 3-TLCROWN
✓	(10) 2-BSM

ECO3FO

Construct top trim from TLCROWN cleated to TF396. Use BSM trim at baseboard.

NOTE: Glass not included. Open Space for Television: 33"W x 33"H x 22 1/2"D. Shelves will not support television. Not available in Walnut.

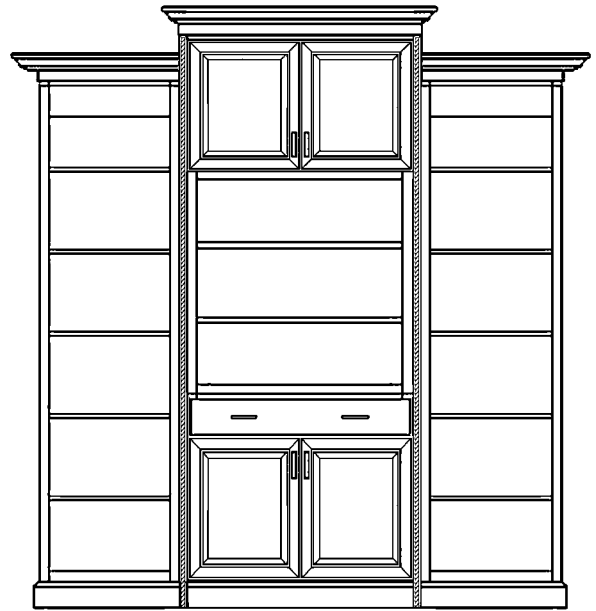

Overall Height: 101 5/16"
(including moulding shown)

Not available in Langley.

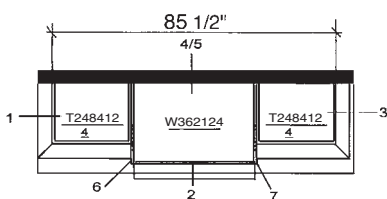

Parts Key
(Aerial View)

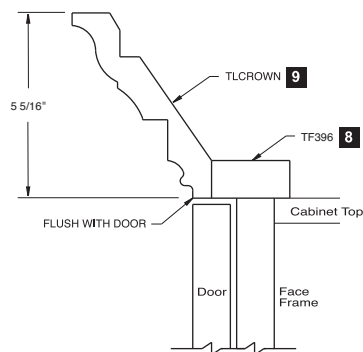

Top Trim

Express Response Program **EXPRESS** RESPONSE

Our Commitment to Channel Partners, Designers and Customers

Diamond Edge's Express Response program is designed to expedite orders when customers need product faster than normal lead times to correct problems with an existing order. Below is an overview of the program and what you can expect from Diamond Edge's commitment to superior service.

Guidelines

- Order must be associated with a previous order number.
- All orders received by 12 NOON E.T. Monday-Friday will be automatically scheduled for Express Response that same day. Orders received after the cutoff time will be processed on the next business day.
- Lead time calculation is based on receipt of a clean order on a credit-worthy account. Clean orders are orders in which all information is provided and accurate.
- There is no additional up-charge for Express Response.
- There are no cancellations or returns once order is received.
- Due to the special nature of the products listed, they are excluded from the Express Response program and will be processed as a standard lead time order.
 - Specials, Appliance Panels, Wood Hoods, and Element Design® Aluminum Frame Doors/Inserts. Contact customer service to help process these requests as standard lead time orders.
- Express Response is available within the continental United States. Should Alaska, Hawaii or international shipments be required, customer service representatives are ready to assist by providing shipping information and determining lead times.

Lead times

12 WORKING DAYS OR LESS FROM ORDER TO DELIVERY (channel partner or home delivery agent):

- Items shipped via LTL (via SuperPAC™) or truckload
- Includes all catalog items except those that can be expedited through the 5-day program listed below and any item finished in a Sherwin-Williams® Fan Deck Color.

20 WORKING DAYS OR LESS FROM ORDER TO DELIVERY (channel partner or home delivery agent):

- Items shipped via LTL (via SuperPAC™) or truckload
- Includes any item finished in a Sherwin-Williams® Fan Deck Color.

5 WORKING DAYS FROM ORDER TO DELIVERY:

- Qualified items are designated in the Pricing/Specification Guide with an icon
- Items will ship via parcel ground
 - Lead time calculation allows for 2 days parcel ground shipping time. Some geographic areas may require additional shipping time.
- For orders containing both 12 day and 5 day items, the longer lead time applies.

QUESTIONS? If you have questions that aren't answered here, contact your Customer Service team.

Diamond Edge Warped Door

Diamond Edge's line of framed cabinetry is constructed to strict specifications, including the moisture content present in wood. When the moisture content is maintained at a constant level, Diamond Edge is able to minimize the amount of expansion and contraction associated with natural wood. When a great amount of expansion and contraction occur, the result can be a warped door. By strictly controlling the amount of humidity present during manufacturing, Diamond Edge is helping to ensure you receive a quality product.

Because wood is a natural product, each piece of wood exhibits its own unique color and grain variations. These differences give wood its genuine beauty. The wood's natural properties also determine how each individual piece will react to changing weather conditions. Therefore, eliminating warped doors is virtually impossible.

If you feel that you have a warped door, Diamond Edge requires that you perform initial testing to determine the extent of the problem.

1. Remove the door from the cabinet and remove all decorative surface knobs or pulls and hinges.
2. Place the door on a completely flat surface, as determined by using a level, and alternately press on opposite corners to observe if the door "rocks" or pulls away from the flat surface.
3. If you observe a gap between the door and the flat surface, measure the distance to determine the amount of warpage.
 - A door must be warped at least 1/4" before it can be considered for replacement. When ordering a replacement by using Diamond Edge Part/Replacement Order Form, be sure to fill in the "Reason for Replacement" section by identifying the applicable warping classification illustrated below.
 - If a door is warped less than 1/4", we recommend you allow a complete heating and cooling cycle (summer to winter season change) to allow the door to reach a moisture equilibrium. Adding magnetic catches or roller catches will often correct minor problems.
4. If the door does not pull away from the flat surface, it is not warped. Most likely, there is a problem with the cabinet installation. When cabinets are not installed in a level or plumb position, they become racked and will cause the door to appear warped. To check for a racked cabinet, place a level on one end rail. The bubble in the level will appear centered if the cabinet was properly installed in a level position. Now place the level on the other end rail.

Again, if the bubble appears centered, the cabinet is properly installed in a level position. Any variations in the location of the bubble will indicate the cabinet was not properly installed. (A plumb bob will reveal the same information.)

Another proper installation check is to place the level on the top, and then bottom, of the installed cabinet's face frame. Identify the bubble's position in both, top and bottom, locations of the face frame. The bubble's position will indicate if the cabinet was properly installed.

Glossary

- LEVEL: (v) A term used to describe a true horizontal line.
(n) A device for establishing a horizontal line or plane by means of a bubble in liquid that shows adjustment to the horizontal by movement to the center of a slightly bowed glass tube.
- PLUMB: (v) A term used to describe a true vertical line. If something is "out of plumb," it is not exactly straight up and down.
- RACK: (v) The action of straining or wrenching through improper installation.
- WARP: (v) The action of twisting or bending out of a true flat or level surface.

Diamond Edge Warped Door (cont'd)

Classification of Warping

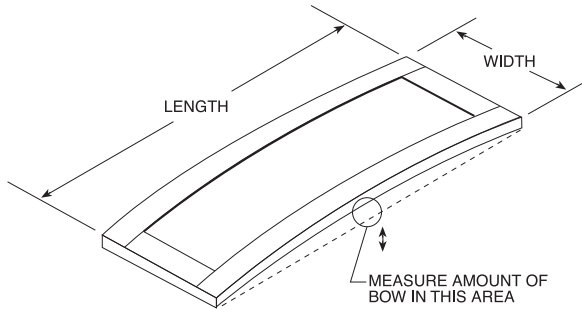

BOW – VERTICAL DEVIATION (UP OR DOWN) FROM A TRUE FLAT PLANE. A BOW IS USUALLY ASSOCIATED WITH THE LENGTH.

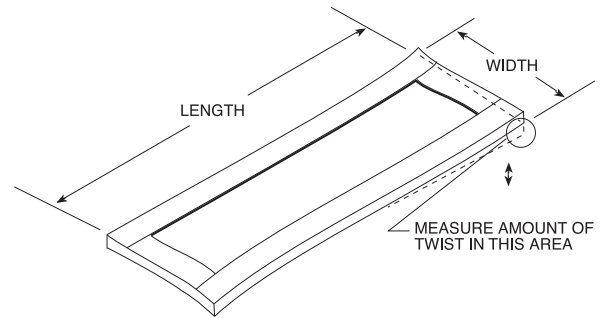

TWIST – VERTICAL DEVIATION (UP AND DOWN) FROM A TRUE FLAT PLANE. TWIST USUALLY OCCURS TO JUST THE CORNER(S) OR END.

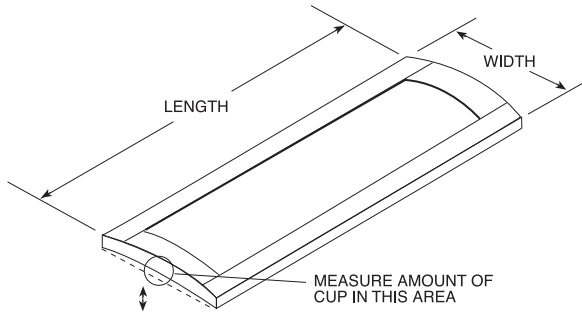

CUP – VERTICAL DEVIATION (UP OR DOWN) FROM A TRUE FLAT PLANE. A CUP IS USUALLY ASSOCIATED WITH THE WIDTH.

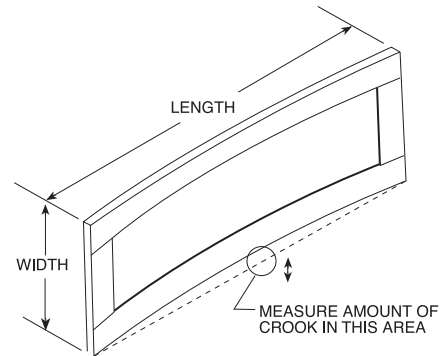

CROOK – HORIZONTAL DEVIATION (SIDE TO SIDE) FROM A TRUE EDGE. A CROOK IS USUALLY ASSOCIATED WITH THE LENGTH.

Policies

Limited Lifetime Warranty (Residential Purchaser)

Diamond® Edge™ Series has a Limited Lifetime Warranty. For terms & conditions, please visit: <https://www.diamondcabinets.com/warranty>.

Humidification

<https://www.masterbrand.com/humidification>

Cabinet Installation Instructions

<https://www.masterbrand.com/installation>

Cabinet Care and Cleaning

<https://www.masterbrand.com/care-and-cleaning>

KCMA



Every Diamond Edge finish has exceeded the KCMA (Kitchen Cabinet Manufacturing Association) standard for durability, stain, moisture, and temperature resistance (ANSI/KCMA A161.1-2000).

Diamond®

EDGE™ SERIES

CC Log #: _____
Internal Use Only

Sherwin-Williams® Color Sample Waiver Form

Fax: 877.333.7122

Email: edgeorders@masterbrand.com

Dear Diamond Edge Customer,

Thank you for selecting Diamond Edge cabinetry and taking advantage of our Sherwin-Williams® Color program.

Your satisfaction is important to Diamond Edge so we want you to fully understand the characteristics that make painted finishes so distinctive. It is important to realize that the beauty of wood cabinetry really comes from natural qualities of wood itself. The textures of natural grain patterns often remain visible in some species and should be accepted as inherent characteristics when selecting cabinetry. When Maple painted finishes (Paints, Sherwin-Williams or Brushed Technique) are specified, the center panels of the selected style may be constructed of Medium Density Fiberboard (MDF). MDF provides a smoother finish when painted, and is more resistant to warping, expansion, and contraction.

In addition, as the wood naturally expands and contracts with varying weather conditions, slight joint separation may occur. These may become visible as small cracks in the finish, particularly in the joint areas. Joint separation may be more apparent on mitered door styles, therefore painted finishes are not recommended for use in environments with extremely high or low humidity levels. Also over time, there may be slight color shift in these finishes due to continued exposure to natural and artificial light sources and other environmental factors. We mention these characteristics because neither Diamond Edge nor your dealer can be held responsible for these conditions and variations.

Sherwin-Williams® samples are shown on materials other than wood. Wood will have a different appearance when the color is applied to the actual door or cabinet. This is due to different material properties, textures and sheen levels.

I have read the foregoing and understand that normal color variation is found from "color swatch to color swatch" and from "paper media to solid wood." I have decided to forego the recommended process of ordering a sample door, assuring a more accurate color match to the final finished product. I also understand the above mentioned wood characteristic information and agree not to hold Diamond Edge and/or the Diamond Edge Dealer responsible in the event these wood and color characteristics are later found by me to be less desirable than expected.

Customer Signature/Date

Dealer Representative Signature/Date

Customer Name (please print)

Dealer Representative Name (please print)

Painted Finish Agreement

Diamond[®]

EDGE™ SERIES

Painted Finish Agreement

Fax: 877.333.7122

Email: edgeorders@masterbrand.com

Alpaca, Paint, and Paint with Penned Cabinetry Agreement. Applies to Maple, MDF, and Quartersawn Oak Door Styles.

Dear Diamond Edge Customer,

Congratulations on your selection of Diamond Edge cabinetry. Because of their unique characteristics, these finishes are quite different from other cabinetry finishes you may be familiar with. Your satisfaction is important to Diamond Edge, and we want you to fully understand the characteristics that make painted finishes so distinctive.

In addition, as the wood naturally expands and contracts with varying weather conditions, slight joint separations may occur; these may become visible as small cracks in the finish, particularly in joint areas. When Maple painted finishes (Paints, Sherwin-Williams or Brushed Technique) are specified, the center panels of the selected style may be constructed of Medium Density Fiberboard (MDF). MDF provides a smoother finish when painted, and is more resistant to warping, expansion, and contraction. **Joint separation may be more apparent on mitered doors; therefore, the finishes listed above are not recommended for use in environments with extremely high or low humidity levels.** Also, over time, there may be a slight color shift in these finishes due to continued exposure to natural and artificial light sources. We mention these characteristics because neither Diamond Edge nor your Diamond Edge dealer can be responsible for these conditions and variations.

Accordingly, Diamond Edge orders for cabinetry with the above listed finishes must be accompanied by this letter of agreement bearing the customer's signature.

I have read the foregoing and find that the characteristic variations of wood are desirable. As such, I agree not to hold Diamond Edge and/or the Diamond Edge dealer listed below responsible in the event that these characteristics are later found by me to be less desirable than I had expected.

Customer Signature/Date

Dealer Signature/Date

Customer Name (please print)

Dealer Name (please print)

Dealer Purchase Order Number



EDGE™ SERIES

Rustic Alder Agreement

Fax: 877.333.7122

Email: edgeorders@masterbrand.com

Dear Diamond Edge Customer,

Congratulations on your selection of Diamond Edge cabinetry in Rustic Alder. Because of its unique characteristics, Rustic Alder is quite different from other wood types you may be familiar with. Your satisfaction is important to Diamond Edge, and we want you to fully understand the characteristics that make Rustic Alder so distinctive.

It is important to realize that the beauty of wood cabinetry really comes from the natural qualities of wood itself. Rustic Alder is characterized by its light brown and reddish undertones and may contain a variety of pin holes, open and closed knots of various sizes and colors, small cracks, bird pecks, mineral streaks, and grain variation. Some knots may have small holes through the panel. Larger holes will not be filled. In addition, the wood will contain color difference caused by variations in minerals found in the soil, creating visible mineral tracks. However, those characteristics that might compromise the structural integrity of the door will not be included.

Sound Closed Knot (not moveable) – Expected in Rustic Alder up to approximately 3” diameter.

Sound Knot with Cracks – Expect sound knots with open cracks up to approximately 1” in length.

Open Knot (through door) – Expected in Rustic Alder with open area up to approximately 3/4” diameter.

Note: 3/4” diameter is about the size of a penny. Holes created by open knots pass completely through the door and are desirable for this rustic look.

Unsound Knot (moveable core) – Not to be expected.

Knot Cluster (cluster of tight sound knots) – To be expected in Rustic Alder.

Worm Holes/Pin Holes (can go through door) – Can be expected on Rustic Alder up to approximately 1/4” diameter.

Worm Tracks – Can be expected on Rustic Alder in sizes up to approximately 1/8” wide by 8” long.

Rustic Alder as described is featured for doors, drawer fronts, and selected mouldings. Other areas of the product will utilize Alder. Customers should expect a much lower occurrence of rustic characteristics in these other areas. The natural characteristics mentioned occur randomly in Rustic Alder. All doors, drawer fronts, and selected mouldings will contain some combination of the common Rustic Alder markings; however, it will be uncommon to find all markings on any single piece. We mention these characteristics because neither Diamond Edge nor your Diamond Edge dealer can be responsible for these conditions and variations.

Accordingly, Diamond Edge orders with Rustic Alder must be accompanied by this letter of agreement bearing the customer’s signature.

I have read the foregoing and find that the characteristic variations of wood are desirable. As such, I agree not to hold Diamond Edge and/or the Diamond Edge dealer listed below responsible in the event that these characteristics are later found by me to be less desirable than I had expected.

Customer Signature/Date

Dealer Signature/Date

Customer Name (please print)

Dealer Name (please print)

Dealer Purchase Order Number

Inset Cabinetry Awareness Agreement

Diamond®

EDGE™ SERIES

Inset Cabinetry Agreement

Fax: 877.333.7122

Email: edgeorders@masterbrand.com

Dear Diamond Edge Customer,

Congratulations on your selection of Diamond Edge Inset cabinetry. Because of the design and construction, inset cabinetry is quite different than a traditional overlay construction. Proper environmental, storage, and installation procedures are critical to the ultimate satisfaction of inset cabinetry. Your satisfaction is important to Diamond Edge and we want you to fully understand the procedures for inset cabinetry.

Inset doors and drawer fronts are made to fit inside the frame with tight tolerances. Inset cabinets are much more vulnerable to dimensional changes and racking caused by incorrect environmental conditions or improper installation.

Important Procedures

- Inset cabinetry that is delivered and stored prior to installation must be stored in a climate controlled environment. Inset cabinetry should be allowed to acclimate in the install location(s) for 48 hours prior to installation. Relative humidity levels should be kept between 30% to 55%.
- Inset cabinets must never be installed in an environment where temperature and humidity reach extreme levels. Relative humidity levels should be kept between 30% to 55%.
- Racking can occur if a cabinet is not installed properly. If the cabinet is installed and forced out of square, it is possible to make the unit nonfunctional, as the doors and drawers will bind. The use of shims will be required to maintain proper level and plumb dimension.
- Inset cabinets should be installed by experienced and patient installers. Inset cabinets require additional time to install and adjust components to the correct positioning and function.
- Doors and drawers removed during installation must be re-installed to their original location within the specific cabinet in which they shipped from the factory.

The inset cabinetry experience and satisfaction is highly dependent upon following proper procedures as described above. Improper adherence to these procedures will void the Diamond Edge warranty.

Accordingly, Diamond Edge orders with inset construction must be accompanied by this letter of agreement bearing the customer's signature.

I have read the foregoing text and understand the importance of proper environmental, storage, and installation procedures for inset cabinetry. As such, I agree not to hold Diamond Edge responsible in the event that these procedures are not followed.

Customer Signature/Date

Dealer Signature/Date

Customer Name (please print)

Dealer Name (please print)

Dealer Purchase Order Number

Aluminum Frame Door Order Form

Fax: 877.333.7122
 Email: edgeorders@masterbrand.com

Customer Name _____	PO _____
Customer Account # _____	Pg ____ of ____

Item	Model	Profile	Finish	Choose door to be modified if there is an upper and lower door.	Decorative Hardware Drilling
<input type="checkbox"/>	<input type="checkbox"/>	<input type="checkbox"/> AF003 <input type="checkbox"/> AF006 <input type="checkbox"/> AF007	<input type="checkbox"/> Black <input type="checkbox"/> Brushed Stainless Steel <input type="checkbox"/> Natural Aluminum <input type="checkbox"/> Oil Rubbed Bronze <input type="checkbox"/> White	<input type="checkbox"/> .TOP <input type="checkbox"/> .BTM	<input type="checkbox"/> No Drilling <input type="checkbox"/> Knob Drilling – specify K1 & K2 <input type="checkbox"/> Pull Drilling – specify K1, K2 & KC K1 _____ (knob or pull) (Std = centered on frame) K2 _____ (knob or pull) (min = 2 1/4", Std = 2 1/2") KC _____ (pull only) (center to center)

Glass	
<input type="checkbox"/> Clear Glass	AF_CLEAR
<input type="checkbox"/> Satin Glass	AF_SATIN

Backpainted Glass Finish	
<input type="checkbox"/> White Gloss	AF_WHITE_GLO
<input type="checkbox"/> White Matte	AF_WHITE_MAT
<input type="checkbox"/> Bronze Gloss	AF_BRONZE_GLO
<input type="checkbox"/> Bronze Matte	AF_BRONZE_MAT

Metallic Inserts	
<input type="checkbox"/> Aluminum Lam	AF_ALUMINUM
<input type="checkbox"/> Brushed Stainless Lam	AF_STAINLESS
<input type="checkbox"/> Platinum Ice Ac	AF_PLATINUM

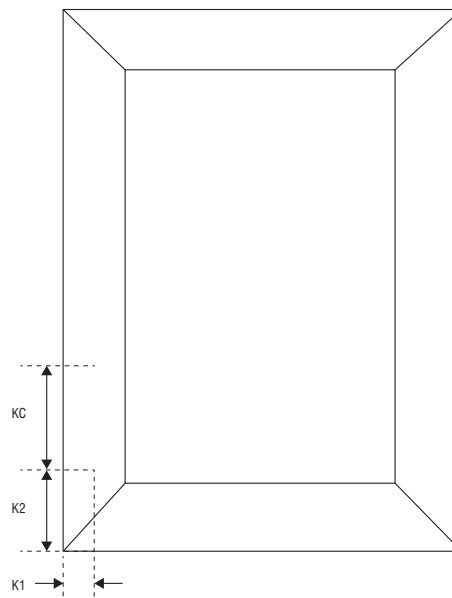

Decorative Appliance Panel Request Form

Fax: 877.333.7122

Email: edgeorders@masterbrand.com

Use one form per appliance.

STEP 1: Provide Order Information

DEALER ACCOUNT #: _____ DESIGNER NAME _____
CUSTOMER NAME: _____ PHONE #: _____
DEALER EMAIL: _____ FAX: _____
DOOR STYLE: _____ WOOD: _____ FINISH: _____
DRAWER FRONT OPTION (STD, DFF5PC, DFR5PC, or DFSLB): _____
FULL OVERLAY, NON-BEAD INSET, or BEAD INSET: _____ PROFILE #: _____

STEP 2: Select Appliance Panel to be Quoted (Check one per worksheet)

Refrigerator / Freezer Panel Undercounter Refrigerator / Freezer Panel Ice Maker Panel
 Trash Compactor Panel Dishwasher Panel Warming Drawer Panel

Manufacturer: _____ Model #: _____
(i.e. GE, Sub-zero, U-line, etc.) (List full model #)

• Handle Type: J-Handle Tubular Handle Aftermarket Handle

STEP 3: Provide Additional Appliance Information

- What type of appliance panel is preferred for the appliance?
 - Installation Type
 - Standard
 - Flush Inset
 - Panel Application
 - 1/4" finished plywood veneer panel.
 - Framed
 - Framed panels are a 1/4" plywood panel with a decorative door applied.
 - Framed panels will typically use J-style handles and require a reveal on all sides.
 - Overlay
 - Overlay panels will typically have a backer panel and overlay panel.
 - Overlay panels will use a handle applied to the front of the decorative door.
 - Integrated
 - Integrated panels are a cabinet door or drawer front only with no backer panel.
 - Maximum single panel door width is 27".
- Planned finish height for refrigerator: _____
- Is a decorative panel needed for the compressor grill area?
 - Yes (Note: If ice dispenser, field cut-out is required.) No
- Does appliance have an external ice dispenser in the door?
 - Yes No
- Is an additional panel trim kit from the appliance manufacturer required?
 - Yes. Trim kit model #: _____ No Unknown
- If ordering warming drawer, warming drawer will be installed into: _____

STEP 4: Include Special Instructions

• Special instructions/requests: _____

STEP 5:

- Email completed form along with panel specification sheets from appliance manufacturer to Customer Service.
- Quote will be returned within 2 business days (excluding weekends).

NOTE: If appliance panel is not quoted prior to placing kitchen order, entire order will be delayed.

STEP 6: Place and Order via 20/20

Refer to page H•2 for door style size guidelines.